

HI801

iris

**VISIBLE  
SPECTROPHOTOMETER**



INSTRUCTION MANUAL





**HI801**

**iris<sup>®</sup>**

**VISIBLE  
SPECTROPHOTOMETER**

Dear  
Customer,

Thank you for choosing a Hanna Instruments® product.

Please read this instruction manual carefully before using this instrument.

This manual will provide you with the necessary information for correct use of this instrument, as well as a precise idea of its versatility.

If you need additional technical information, do not hesitate to e-mail us at [tech@hannainst.com](mailto:tech@hannainst.com) or view our contact list at [www.hannainst.com](http://www.hannainst.com).



# INTRODUCTION

The HI801 iris<sup>®</sup> visible spectrophotometer is a compact and versatile instrument with a split beam optical system. It features a visible wavelength range from 340 to 900 nm. The meter features an internal reference system that reduces errors caused by lamp intensity and temperature fluctuations. The optical system has been designed to minimize stray light, improving linearity and accuracy.

The spectrophotometer is supplied with 96 factory methods. These methods are pre-programmed with all of the information necessary to complete an analysis, including the wavelength, vial type, calibration curve and timers. Up to 100 user methods can be created. Users can select up to 5 wavelengths and timers, cuvette type and enter their own calibration curves (concentration only). Calibration curves can contain up to 10 points, with a linear regression curve fit to the data. The slope, offset and R-squared ( $R^2$ ) are visible for the calibration curve. Both factory and user methods are easily accessible from the main screen using the favorite methods option.

- Supplied with 96 factory methods
- Create up to 100 user methods
- 5 cuvette types (16 mm round, 22 mm round, 13 mm vial, 10 mm square, 50 mm rectangular) with automatic detection
- Data storage for 9999 measurements with ability to auto log results
- Simplified data transfer to a PC or Mac
- Field upgradeable firmware
- Rechargeable battery

This manual provides information regarding installation and functionality of the spectrophotometer and refined operation suggestions. Before using the spectrophotometer, it is recommended users become familiar with its various features and functionality.

## PART I. INSTRUCTION MANUAL

Provides a comprehensive description of the operating principles, user interface, general options etc.

## PART II. FACTORY METHODS

Contains complete instructions for commonly-used analyses. Additional methods and method packs are available, contact your local Hanna Instruments<sup>®</sup> office for more details.



## TABLE OF CONTENTS

### PART I. INSTRUCTION MANUAL

1. Preliminary Examination.....	1-3
2. Safety Measures .....	1-4
3. Specifications .....	1-5
4. Abbreviations.....	1-6
5. Description .....	1-7
5.1. Principle of Operation .....	1-7
5.2. Precision & Accuracy.....	1-8
5.3. Functional Description & LCD Display .....	1-9
5.3.1. Keypad Description .....	1-10
5.3.2. LCD Description.....	1-11
5.4. Optical System.....	1-12
6. Operating Mode.....	1-13
6.1. Start Up .....	1-13
6.2. Power Connection & Battery Management .....	1-13
6.3. Cuvette & Vial Adapters .....	1-14
6.4. Methods.....	1-15
6.4.1. Factory Methods .....	1-15
6.4.2. User Methods .....	1-16
6.4.3. Favorite Methods.....	1-17
6.4.4. Create New .....	1-17
6.5. Timers.....	1-18
6.6. Chemical Formula / Unit Conversion .....	1-18
6.7. Data Management .....	1-19
6.7.1. Log Data .....	1-19
6.7.2. Log Recall .....	1-19
6.7.3. Data Transfer.....	1-19
7. Setup.....	1-20
7.1. Meter Setup.....	1-20
7.1.1. Favorite Methods.....	1-20
7.1.2. Automatic Log .....	1-20
7.1.3. Meter ID .....	1-21
7.1.4. Sample ID.....	1-21
7.1.5. Beeper.....	1-21
7.1.6. LCD Contrast.....	1-22
7.1.7. Letter Scroll.....	1-22
7.1.8. CSV Field Separator .....	1-23



7.1.9. Date & Time Setting.....	1-23
7.1.10. Cuvette Detection.....	1-24
7.1.11. Auto Off.....	1-24
7.1.12. Factory Reset.....	1-25
7.1.13. Reset Configuration.....	1-25
7.2. System Check.....	1-25
7.2.1. System Info.....	1-25
7.2.2. Upgrade.....	1-26
7.2.3. Lamp Check.....	1-26
7.2.4. Lamp History.....	1-26
7.2.5. Wavelength Check.....	1-26
7.3. USB.....	1-27
7.3.1. Methods.....	1-27
7.3.2. Reports.....	1-28
7.3.3. Connect to PC.....	1-31
7.4. Method Settings (User Methods Only).....	1-31
7.4.1. Measurement Unit.....	1-31
7.4.2. Number of Wavelengths (except for ABS or %T methods).....	1-31
7.4.3. Wavelength Settings.....	1-32
7.4.4. Decimals.....	1-32
7.4.5. Dilution Factor.....	1-32
7.4.6. Vial Type.....	1-32
7.4.7. Number of Timers.....	1-33
7.4.8. Timer Setting.....	1-33
7.4.9. Multi Wavelength Formula.....	1-34
7.4.10. Calibration.....	1-35
8. Spare Parts.....	1-40
8.1. Battery Replacement.....	1-40
8.2. Lamp Replacement.....	1-41
9. Warning & Error Messages.....	1-45
9.1. Warning Messages.....	1-45
9.2. Error Messages.....	1-46



## PART II. FACTORY METHODS

1. Collecting & Measuring Samples and Reagents.....	2-3
1.1. Proper Use of Automatic Fixed-Volume Pipettes .....	2-3
1.2. Proper Use of Syringe .....	2-3
1.3. Proper Use of Dropper Bottle .....	2-3
1.4. Proper Use of Powder Packet .....	2-3
2. Cuvette Preparation.....	2-4
3. Method List by ID.....	2-6
4. Method Procedures.....	2-7
Alkalinity .....	2-7
Alkalinity, Marine .....	2-9
Aluminum .....	2-11
Ammonia Low Range .....	2-14
Ammonia Low Range (13 mm Vial) .....	2-16
Ammonia Medium Range .....	2-18
Ammonia High Range.....	2-20
Ammonia High Range (13 mm Vial) .....	2-22
Bromine.....	2-24
Calcium .....	2-26
Calcium, Marine .....	2-29
Chloride.....	2-31
Chlorine Dioxide .....	2-34
Chlorine Dioxide (Rapid).....	2-37
Chlorine, Free Ultra Low Range .....	2-40
Chlorine, Free Low Range (Powder Reagent).....	2-42
Chlorine, Free Low Range (Liquid Reagent) .....	2-44
Chlorine, Free High Range.....	2-46
Chlorine, Total Ultra Low Range .....	2-48
Chlorine, Total Low Range (Powder Reagent).....	2-50
Chlorine, Total Low Range (Liquid Reagent) .....	2-52
Chlorine, Total High Range .....	2-55
Chlorine, Total Ultra High Range .....	2-58
Chromium (VI) Low Range.....	2-60
Chromium (VI) High Range .....	2-62
Chromium (VI)/Total (13 mm Vial) .....	2-64
Chemical Oxygen Demand Low Range EPA (13 mm Vial) .....	2-68
Chemical Oxygen Demand Low Range Mercury Free (13 mm Vial) .....	2-71
Chemical Oxygen Demand Low Range ISO (13 mm Vial).....	2-74
Chemical Oxygen Demand Medium Range EPA (13 mm Vial) .....	2-77



Chemical Oxygen Demand Medium Range Mercury Free (13 mm Vial) .....	2-80
Chemical Oxygen Demand Medium Range ISO (13 mm Vial) .....	2-83
Chemical Oxygen Demand High Range EPA (13 mm Vial) .....	2-86
Chemical Oxygen Demand Ultra High Range (13 mm Vial) .....	2-89
Color of Water .....	2-92
Copper Low Range .....	2-94
Copper High Range .....	2-96
Cyanide .....	2-98
Cyanuric Acid .....	2-101
Fluoride Low Range .....	2-103
Fluoride High Range .....	2-106
Hardness, Calcium .....	2-109
Hardness, Magnesium .....	2-112
Hardness, Total Low Range .....	2-115
Hardness, Total Medium Range .....	2-118
Hardness, Total High Range .....	2-121
Hydrazine .....	2-124
Iodine .....	2-126
Iron Low Range .....	2-128
Iron High Range .....	2-131
Iron (II) (Ferrous) .....	2-133
Iron (13 mm Vial) .....	2-136
Iron Total (13 mm Vial) .....	2-139
Magnesium .....	2-143
Manganese Low Range .....	2-145
Manganese High Range .....	2-148
Maple Syrup .....	2-150
Molybdenum .....	2-152
Nickel Low Range .....	2-155
Nickel High Range .....	2-158
Nitrate .....	2-160
Nitrate Chromotropic Acid (13 mm Vial) .....	2-162
Nitrite, Marine Ultra Low Range .....	2-164
Nitrite Low Range .....	2-166
Nitrite Low Range (13 mm Vial) .....	2-168
Nitrite Medium Range (13 mm Vial) .....	2-171
Nitrite High Range .....	2-174
Nitrogen, Total Low Range (13 mm Vial) .....	2-176
Nitrogen, Total High Range (13 mm Vial) .....	2-181



Oxygen, Dissolved.....	2-186
Oxygen Scavengers (Carbohydrazide).....	2-189
Oxygen Scavengers (Diethylhydroxylamine) (DEHA).....	2-191
Oxygen Scavengers (Hydroquinone).....	2-193
Oxygen Scavengers (Isoascorbic Acid).....	2-195
Ozone.....	2-197
pH.....	2-201
Phosphorus, Marine Ultra Low Range.....	2-203
Phosphate Low Range.....	2-205
Phosphate High Range.....	2-207
Phosphorus, Acid Hydrolyzable (13 mm Vial).....	2-209
Phosphorus, Reactive Low Range (13 mm Vial).....	2-212
Phosphorus, Reactive High Range (13 mm Vial).....	2-214
Phosphorus, Total Low Range (13 mm Vial).....	2-217
Phosphorus, Total High Range (13 mm Vial).....	2-220
Potassium Low Range.....	2-224
Potassium Medium Range.....	2-226
Potassium High Range.....	2-228
Silica Low Range.....	2-230
Silica High Range.....	2-233
Silver.....	2-236
Sulfate.....	2-240
Surfactants, Anionic.....	2-242
Surfactants, Anionic (13 mm Vial).....	2-246
Surfactants, Cationic (13 mm Vial).....	2-249
Surfactants, Nonionic (13 mm Vial).....	2-252
Zinc.....	2-255
5. Alphabetical List of Methods.....	2-258
6. Accessories.....	2-261
6.1. Reagent Sets.....	2-261
6.2. Other Accessories.....	2-266
Certification.....	2-268
Recommendations for Users.....	2-268
Warranty.....	2-268



# PART I. INSTRUCTION MANUAL



# INSTRUCTION MANUAL

## 1. PRELIMINARY EXAMINATION

Remove the instrument and accessories from the packaging and examine it carefully. For further assistance, please contact your local Hanna Instruments® office or email us at [tech@hannainst.com](mailto:tech@hannainst.com).

Each HI801 iris® spectrophotometer is supplied with:

- Sample cuvette and cap, 22 mm (4 pcs.)
- Cuvette adapters (3 pcs.)
- Cloth for wiping cuvettes
- Scissors
- USB cable
- 15 VDC power adapter
- USB flash drive
- Instrument quality certificate
- Instruction manual

**Note:** Save all packing material until you are sure that the instrument works correctly. Any damaged or defective item must be returned in its original packing material with the supplied accessories.

## 2. SAFETY MEASURES



- The chemicals contained in the reagent kits may be hazardous if improperly handled.
- Read the Safety Data Sheet before performing tests.
- Safety equipment:  
Wear suitable eye protection and clothing when required and follow instructions carefully.
- Reagent spills:  
If a reagent spill occurs, wipe up immediately and rinse with plenty of water. If reagent contacts skin, rinse the affected area thoroughly with water. Avoid breathing released vapors.
- Waste disposal:  
For proper disposal of reagent kits and reacted samples, contact a licensed waste disposal provider.

To prevent injury, death or damage to the instrument:

- Use only the power supply, battery and accessories specified in the manual.
- Do not open, disassemble or modify the battery pack or instrument.
- Do not expose the battery or instrument to excess heat.
- Before storing the instrument for an extended period of time, remove the battery pack and disconnect the power plug.
- Do not use or store the battery or instrument in dusty or humid places.
- Do not shake, drop or subject the instrument to physical shock.
- Do not leave the instrument near objects with strong magnetic fields.

To prevent fire or electrical shock:

- Ensure the power adapter is completely plugged in.
- Never handle the power adapter or battery with wet hands.
- Do not leave the battery or meter near a heat source.
- Do not insert any foreign objects in the power adapter connector or battery compartment.
- Do not recharge battery outside ambient temperature conditions (0 to 45 °C).

**Note:** *If the meter experiences a sudden temperature change allow it to equilibrate before turning on. Condensation may have formed on the instrument and on the internal parts.*

### 3. SPECIFICATIONS

Wavelength range	340 to 900 nm
Wavelength resolution	1 nm
Wavelength accuracy	$\pm 1.5$ nm
Photometric range	0.000 to 3.000 Abs
Photometric accuracy	5 mAbs at 0.000 to 0.500 Abs 1 % at 0.500 to 3.000 Abs
Measurement mode	transmittance (%) absorbance concentration
Sample cell	10 mm square 50 mm rectangular 16 mm round 22 mm round 13 mm round (vial)
Wavelength selection	automatic, based on the selected method (editable for user methods only)
Light source	tungsten halogen lamp
Optical system	split beam
Wavelength calibration	internal, automatic at power-on with visual feedback
Stray light	$< 0.1$ % T at 340 nm with $\text{NaNO}_2$
Spectral bandwidth	5 nm
Number of methods	up to 150 factory (96 pre-loaded) up to 100 user
Data points stored	9999 measured values
Export capability	csv file format pdf file format
Connectivity	1x USB A (mass storage host) 1x USB B (mass storage device)
Battery life	3000 measurements or 8 hours
Power supply	15 Vdc power adapter 10.8 Vdc Li-Ion rechargeable battery
Environment	0 to 50 °C (32 to 122 °F) 0 to 95% RH
Dimensions	155 x 205 x 322 mm (6.1 x 8.0 x 12.6")
Weight	3 kg (6.6 lbs.)

## 4. ABBREVIATIONS

Abs	Absorbance
COD	Chemical Oxygen Demand
EPA	US Environmental Protection Agency
HDPE	High-Density Polyethylene
ISO	International Organization for Standardization\
TBPE	Tetrabromophenolphthalein Ethyl Ester
dkH	degrees of carbonate hardness
°dH	German degree (Hardness)
°e	English degree (Hardness)
°f	French degree (Hardness)
g/L	grams per liter (ppt)
meq/kg	milliequivalents per kilogram
meq/L	milliequivalents per liter
µg/L	micrograms per liter (ppb)
mg/L	milligrams per liter (ppm)
mL	milliliter
%T	Percent Transmittance
PCU	Platinum Cobalt Unit
Pfund	Honey color grading scale in millimeters
pH	Negative log of the hydrogen ion activity
ppb	parts per billion (µg/L)
ppm	parts per million (mg/L)
ppt	parts per thousand (g/L)
ULR	Ultra Low Range
LR	Low Range
MR	Medium Range
HR	High Range
UHR	Ultra High Range

## 5. DESCRIPTION

### 5.1. PRINCIPLE OF OPERATION

Absorption of light is a typical phenomenon of interaction between electromagnetic radiation and matter.

A spectrophotometer separates electromagnetic radiation (white light) into its component wavelengths and selectively measures the intensity of the radiation after it passes through a sample.

The white light is passed through a prism to disperse the light into bands of color. These bands of color make up the visible light spectrum and correlate to the wavelength.

Wavelength (nm)	Absorbed color	Transmitted color
400	violet	yellow-green
435	blue	yellow
495	green	purple
560	yellow	blue
650	orange	greenish blue
800	red	bluish green

When a light beam crosses a substance, some of the radiation may be absorbed by atoms, molecules or crystal lattices. If pure absorption occurs, the fraction of light absorbed depends both on the optical path length through the matter and on the physical-chemical characteristics of the substance according to the Beer-Lambert Law:

$$T = I/I_0$$

$$-\log I/I_0 = \epsilon_\lambda c d$$

or

$$A = \epsilon_\lambda c d$$

T = transmittance

A = absorbance

$I_0$  = intensity of incident light beam

I = intensity of light beam after absorption

$\epsilon_\lambda$  = molar extinction coefficient at wavelength  $\lambda$

c = molar concentration of the substance

d = optical path through the substance

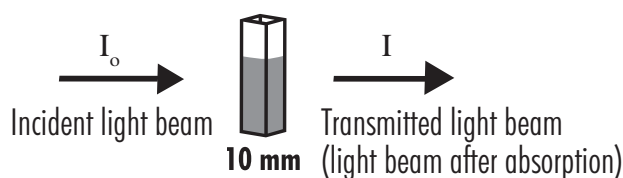

The concentration “c” can be calculated from the absorbance of the substance as the other factors are constant. Photometric chemical analysis is based on specific chemical reactions between a sample and reagent to produce a light-absorbing compound.

## 5.2. PRECISION & ACCURACY

Precision is how closely repeated measurements are to one another. Precision is usually expressed as standard deviation. Accuracy is defined as the closeness of a test result to the true value. Although good precision suggests good accuracy, precise results can be inaccurate.

For each method, the accuracy is expressed in the related measurement section. The figure explains these definitions.

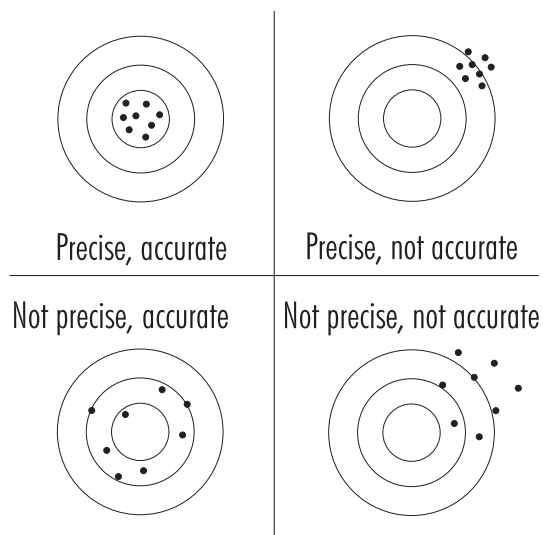



### 5.3. FUNCTIONAL DESCRIPTION & LCD DISPLAY

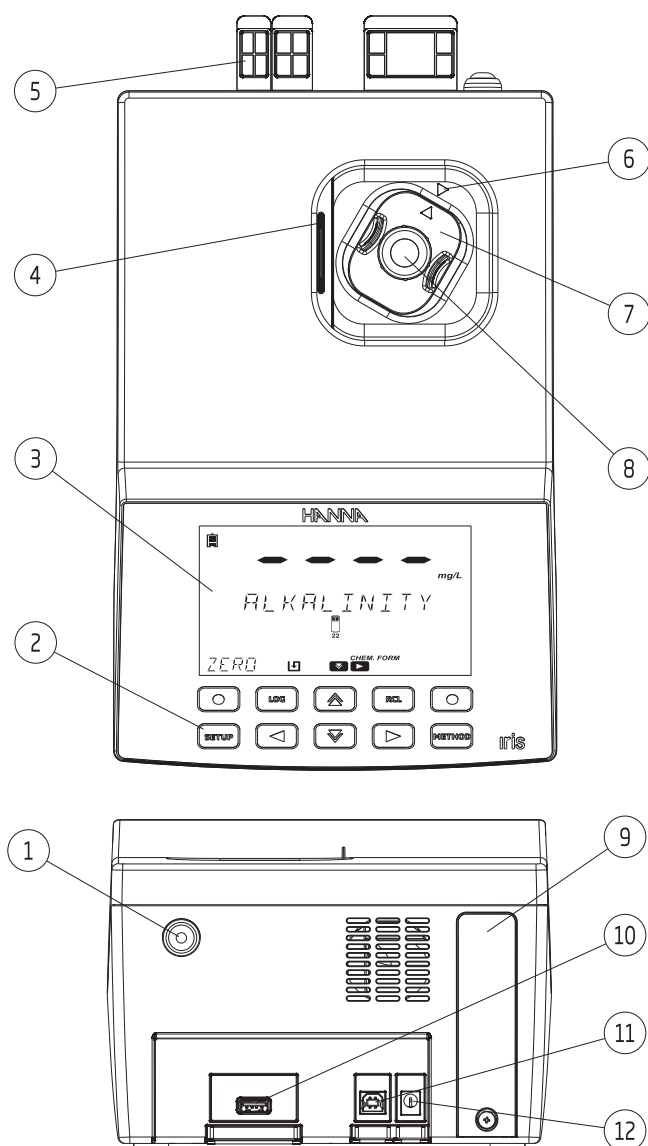









- 1 ON / OFF power button
- 2 Keypad
- 3 LCD
- 4 Lid
- 5 Protective port covers
- 6 Indexing mark
- 7 Cuvette adapter
- 8 Cuvette
- 9 Battery cover
- 10 USB connector for USB flash drive
- 11 USB connector for PC connection
- 12 Power adapter connector

### 5.3.1. KEYPAD DESCRIPTION



The keypad contains 8 direct keys and 2 functional keys with the following functions:

-  Press the functional key to perform the function displayed above it on the LCD
-  Press to access the METHOD menu
-  Press to move up in a menu, to increment a value or to access the FAVORITE METHODS from the MAIN SCREEN
-  Press to go back to a previous menu level, to scroll through letter places in the method creation process or to access the TIMER MENU on the MAIN SCREEN
-  Press to move down in a menu or to decrement a set value
-  Press to advance in the menu, to scroll through letter places in the method creation setup or to access the CHEMICAL FORMULAS for factory methods on the MAIN SCREEN
-  Press to access the SETUP menu
-  Press to save the current measurement
-  Press to recall logged measurements

### 5.3.2. LCD DESCRIPTION

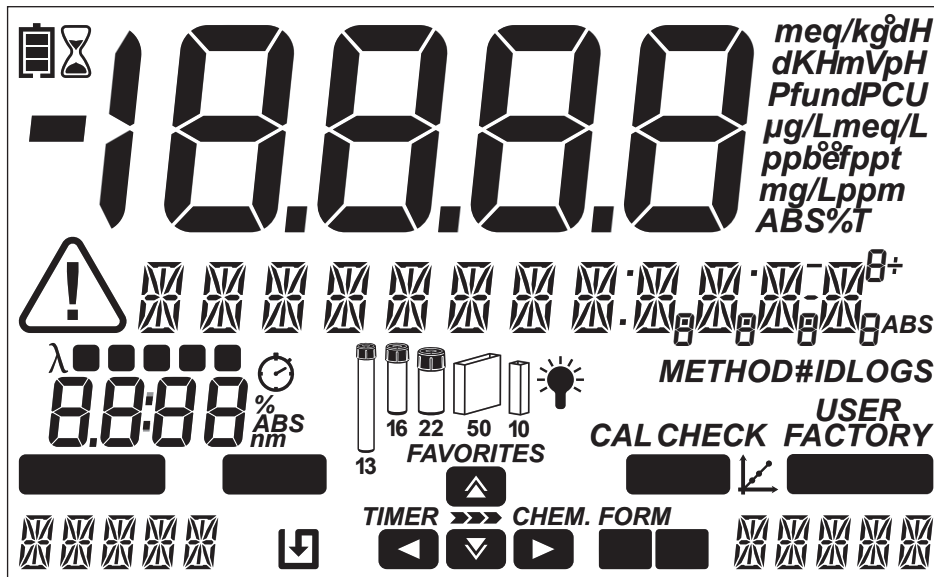

Tag	Description
	Battery status indicator
	Warning indicator
	Timer indicator
$\lambda$	Wavelength indicator
<b>1 2 3 4 5</b>	Wavelength or timer tags
	Vial type indicator for the selected method*
	Lamp status
<b>SETUP LOG RCL METHOD</b>	Indicates the active menu
	Navigation level in menus
	Indicates arrow key is active
	Indicates arrow key is active
	Calibration indicator
	Auto log enabled
<b>USB PC</b>	PC connection established
<b>USB HOST</b>	Flash drive connection established

\*Note: For factory methods the indicated vial must be used to obtain valid measurements.

## 5.4. OPTICAL SYSTEM

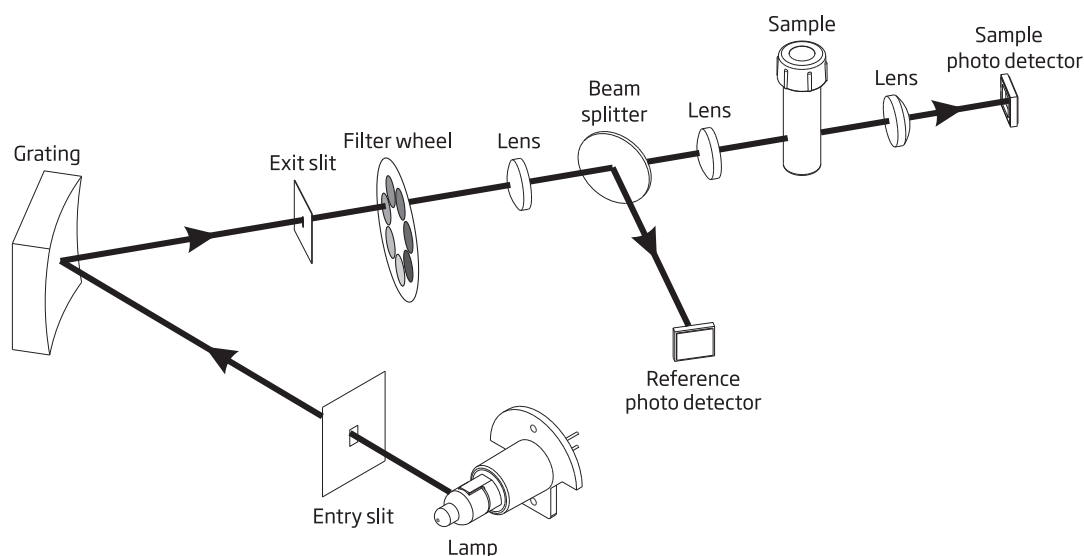

Optical System Block Diagram

A tungsten halogen lamp is used as the light source for the entire working range of the meter (340 nm to 900 nm). The tungsten halogen lamp produces a white light that is passed through a diffraction grating.

The diffraction grating splits the polychromatic white light into the visible color spectrum, allowing for specific wavelengths to be selected.

The light is then passed through an optical filter to reduce stray light and improve measurement accuracy.

The internal reference system uses a reference photo detector to compensate for drifts due to lamp intensity, ambient temperature and environmental changes, providing a stable source of light.

Focusing lenses are used throughout the optical system to ensure all of the light is being collected. This allows a brighter, stronger signal to be received.

After the light exits the cuvette, a final focusing lens is used. This reduces error from cuvette imperfection and scratches, eliminating the need to index the cuvette.

## 6. OPERATING MODE

### 6.1. START UP

When the instrument is powered on, all the LCD tags will be visible for several seconds before the auto-diagnostic tests run. This process will take several seconds, during this time the progress will be displayed on the screen. Once these tests are completed the main screen will be displayed.

These tests ensure that the meter is working properly. If any errors occur a warning message will be displayed.

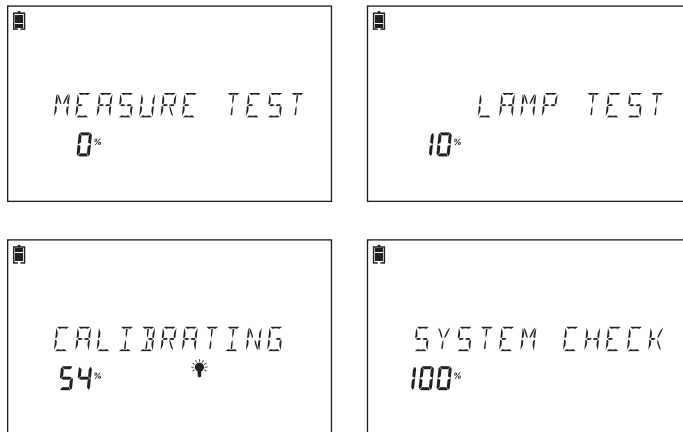

If there are no methods installed, "No Method Loaded" message is displayed.

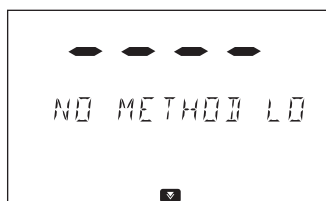

### 6.2. POWER CONNECTION & BATTERY MANAGEMENT

The meter can be powered from an AC/DC power adapter or from the rechargeable battery.

To conserve power, the auto off option can be enabled in the setup menu, see Setup section for more information. If this option is enabled, the instrument will automatically turn off after a defined period of time if no interaction has occurred. The battery icon located on the top left corner indicates battery and charging status.

- Battery is charging from external adapter
- Battery fully charged (connected to power adapter)

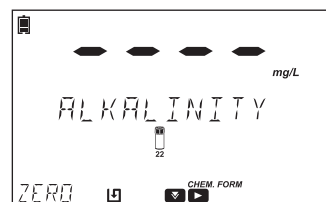
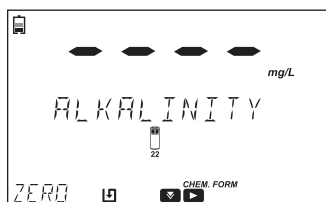

- Battery near 0% (no external power adapter)

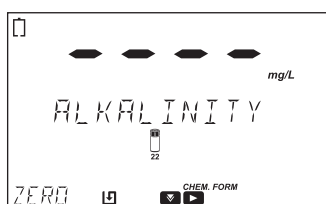

### 6.3. CUVETTE & VIAL ADAPTERS

The meter is supplied with two cuvette adapters and one vial adapter:

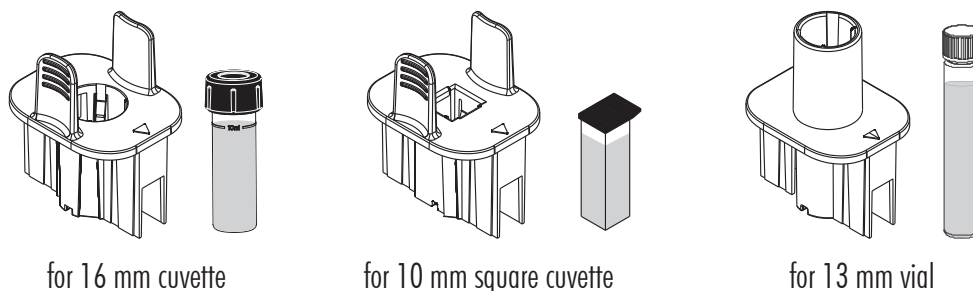

**Note:** The 22 mm round and 50 mm rectangular cuvettes do not require adapters. The cuvettes can be directly inserted into the meter.

To insert the adapter:

1. Open the meter's lid.
2. Select the adapter according to the cuvette type required for the selected method.
3. Orient the adapter so that the indexing mark is aligned with the indexing mark located inside the meter.

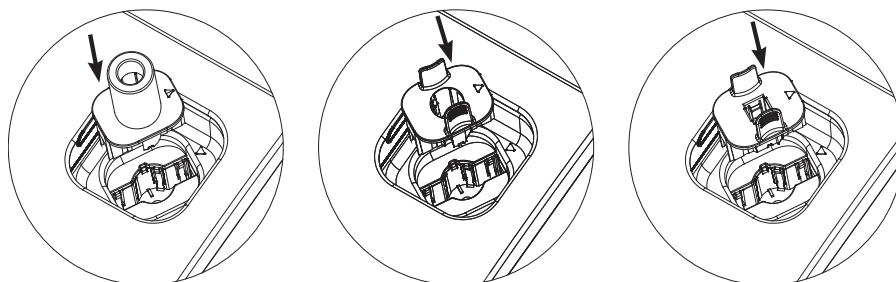

4. Using light pressure, push the adapter down until it reaches the bottom of the meter's holder.

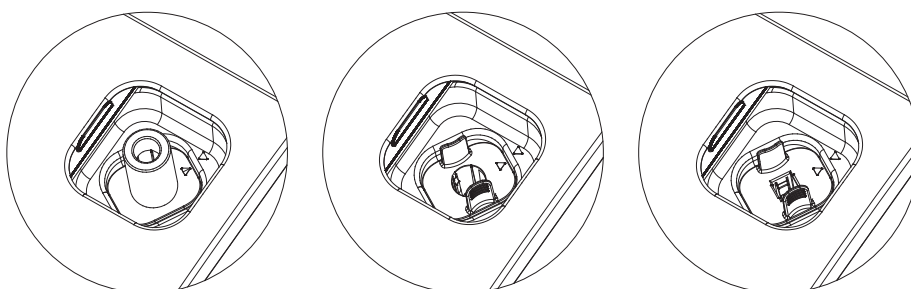

The meter is ready for use.

Always utilize the selected adapter for both "Zero" and "Read" measurements as specified in the method instructions.

**Note:** The meter's lid can't be closed while using the 13 mm vial adapter. This is normal, the vial adapter itself will block out all external light.

**Warning:** Improper use of the vial adapters could cause irreversible damage to the meter. Always use the following precautions when using vial adapters.

- Never use excessive force to insert the adapter. The vial should be inserted by using light pressure only. If the vial is not reaching the bottom, if there is large resistance or if a "light low" error message is displayed during the "Zero" operation, re-check that the indexing marks are aligned on the adapter and meter.
- Never insert hot vials or samples into the vial adapter. Samples should be near room temperature before inserting into the meter or adapter.

## 6.4. METHODS

Option: Factory methods, User methods, Favorite methods (if enabled), Create new

In order to run an analysis a method needs to be loaded.

Press the ▲ or ▼ key to scroll through the available options.

The number of methods will be displayed on the lower left side of the screen.

Press the **METHOD** key to return to the main screen.

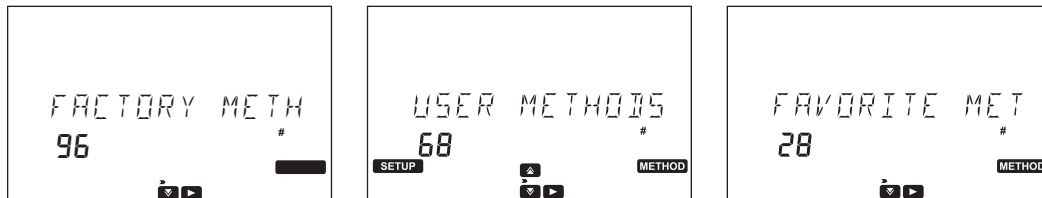

### 6.4.1. FACTORY METHODS

Factory methods were developed by Hanna Instruments® and are pre-programmed with all of the information needed to run an analysis. These methods are calibrated for the selected wavelength, vial type and reagent set. Up to 150 factory methods can be stored on the instrument. Press the ▲ or ▼ key to scroll through the methods. To view the methods by ID press **VIEW**. Press **CFM** to load the selected method.

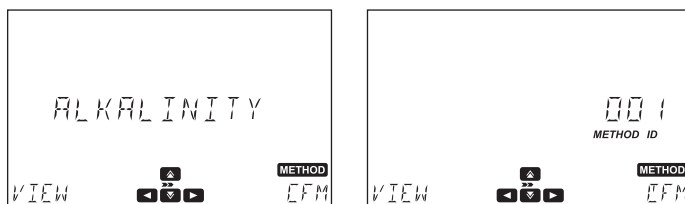

To view the ordering information, method version or to mark the method as a favorite (if enabled) press the ► key.

Press the ▲ or ▼ key to view the available options.

To view the ordering information press **CFM** when "Ordering Info" is displayed.

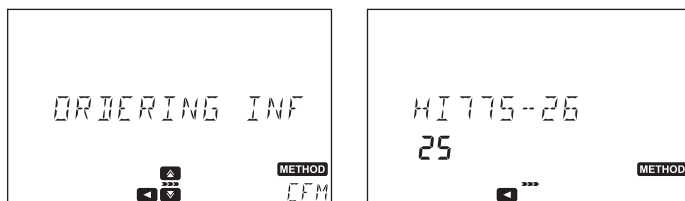

To add a method to the favorites list press **CFM** when "Set Favorite" is displayed. If the method is already tagged as a favorite, "Clear Favorite" is displayed.

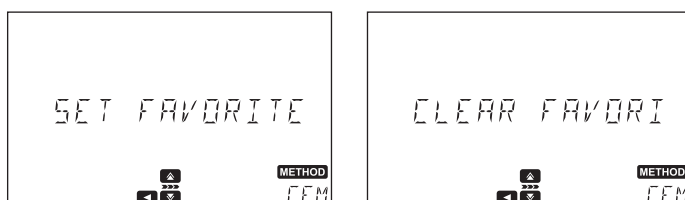

Press the ◀ key to return to the method list.

### 6.4.2. USER METHODS

User methods are developed by the user. These methods can be customized based on the analysis. Options include multiple wavelengths, vial type, reaction timers and calibration curves. Up to 100 user methods can be stored on the instrument. Press the ▲ or ▼ key to scroll through the methods. To view the methods by ID press **VIEW**. Press **CFM** to load the selected method.

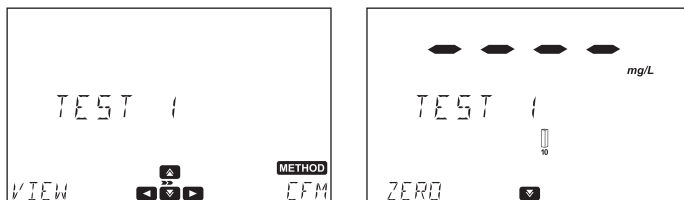

To view additional information press the ► key.

Press the ▲ or ▼ key to view the available options.

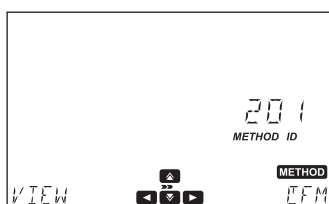

To add a method to the favorites list press **CFM** when "Set Favorite" is displayed. If the method is already tagged as a favorite, "Clear Favorite" is displayed.

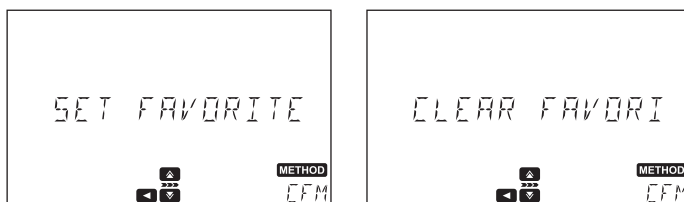

To delete the selected method press **CFM** when "Delete" is displayed.



To rename the selected method press **CFM** when "Rename" is displayed, see Method Name section for additional information.





To export the selected method press **CFM** when "Export" is displayed, see USB section for additional information.

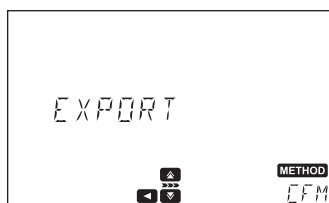

### 6.4.3. FAVORITE METHODS

Frequently used methods can be tagged as favorite methods. Favorite methods can be both factory and user methods. Up to 30 methods can be tagged as favorites.

Once a method has been tagged as a favorite it will appear in the Favorite Method list for easy access when the **METHOD** key is pressed.

Favorite Methods can also be easily accessed from the main screen by pressing the  key.

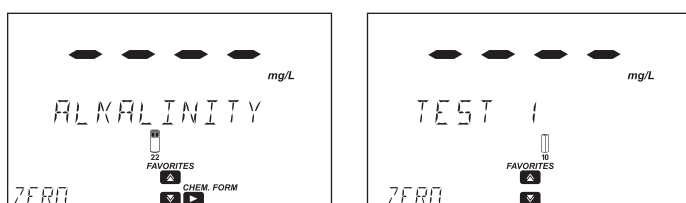

### 6.4.4. CREATE NEW

See User Methods for additional information on creating a new user method.

Press the  key to return to the previous setting.

#### Method Name

**Option: Up to 12 alphanumeric characters**

Press the  or  key to select the desired character. Press the  or  key to move across characters.

Press **CFM** to save and continue or **BACK** to return to the methods menu.

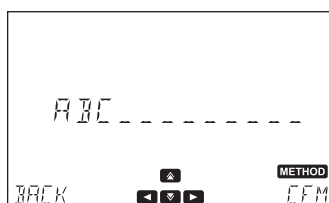

For more information on the settings and options that are available during method creation, see Method Settings (User Methods Only) section.

After all settings have been entered, press **CFM** to create the method. The meter will show "Method Created" before returning to the main screen.

All of these settings can be modified in method settings, see Method Settings (User Methods Only) section for additional information.

In order to use the newly created method that reports in a concentration unit a calibration must be done.

A calibration is not required for methods reporting in absorbance, % transmittance or multiwavelength.

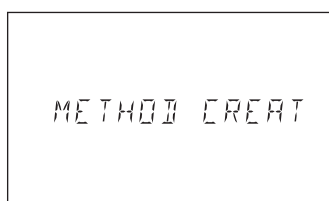

## 6.5. TIMERS

Each method requires a different measurement procedure.

If a timer is used during the measurement procedure the ◀ key will be visible on the main screen with the TIMER tag above it.

Press the ◀ key to access the timer menu. Press **START** to start Timer 1, the display will show the countdown. To stop and reset the timer, press **STOP**.

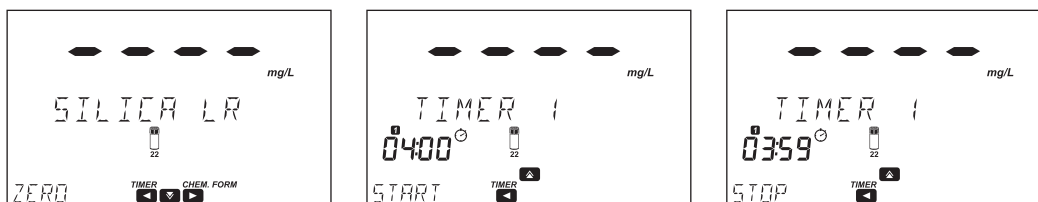

If the method requires more than one timer, press the ◀ key to access the timer menu. Press the ▲ key to select Timer 2 through Timer 5.

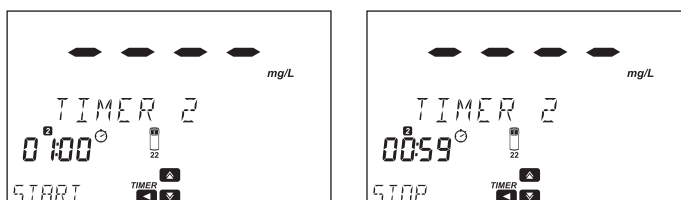

When the timer has expired press **ZERO** or **READ** to continue.

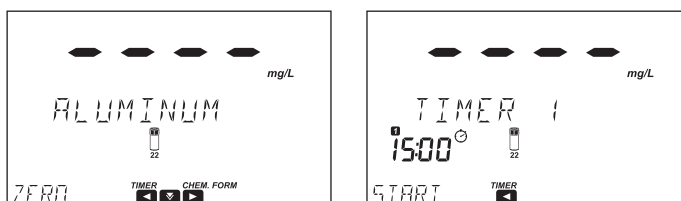

**Note:** A zero measurement must be done before a read measurement. Follow the instructions in the method procedure for preparation of the zero cuvette.

## 6.6. CHEMICAL FORMULA / UNIT CONVERSION

Chemical formulas and conversion factors are preprogrammed into the instrument and are method specific (factory methods only).

On the main screen the ▶ key will be visible with the CHEM. FORM tag above it.

Press the ▶ key to view the default chemical formula.

If additional chemical formulas are available use the ▲ or ▼ key to select a new formula. The results will be converted to the new formula automatically.

Press the ▶ key to return to the measurement screen with the updated chemical formula.

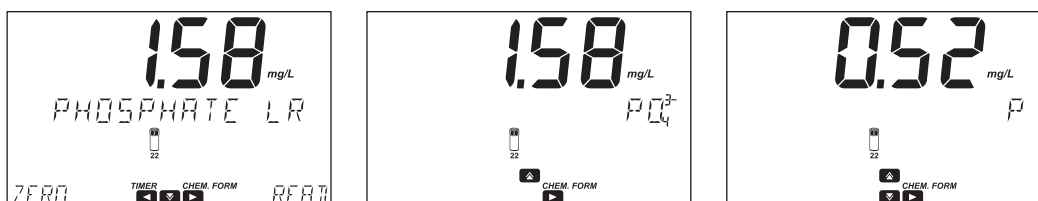

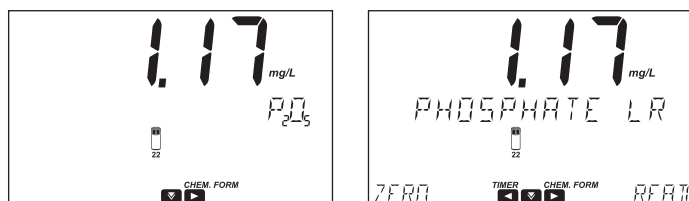

## 6.7. DATA MANAGEMENT

The meter can hold up to 9999 measurements. Data can be reviewed on the screen or transferred to a PC.

### 6.7.1. LOG DATA

If Automatic Log is enabled the meter automatically saves the reading. The  is shown on the display when this feature is enabled, see Automatic Log section for detailed information.

Measurements can also be saved by pressing the **LOG** key.

If Sample ID is enabled (see Sample ID section for additional information), the user will be prompted to enter a unique 2 digit ID for the saved measurement.

The previously entered ID will be displayed automatically.

Press **CFM** to confirm the Sample ID or **CLR** to return to the previous screen.

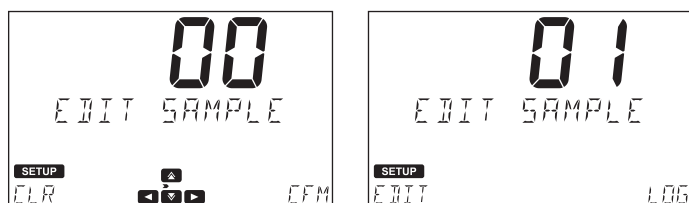

### 6.7.2. LOG RECALL

Data saved on the instrument can be viewed by pressing the **RCL** key.

Logs are displayed in order by date and time, the newest log is shown first. Press the  key to scroll through the available logs. Press **INFO** to view additional information for the selected log. The following information is saved for each measurement: method name, chemical formula (factory methods only), date and time of the measurement, sample ID, method ID, wavelength and absorbance (user methods only).

Individual logs can be deleted by pressing **CLR**, which prompts a confirmation screen: "Are you sure you want to delete this log".

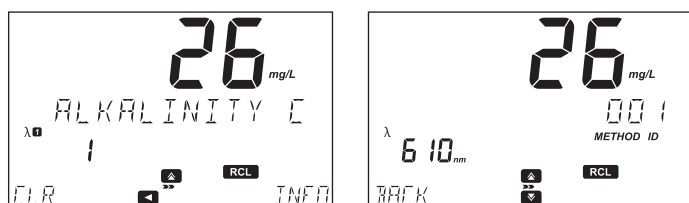

### 6.7.3. DATA TRANSFER

All data stored on the meter can be saved to a PC/ Mac or exported to a USB flash drive. For detailed information please see Setup section.

## 7. SETUP

Option: Method settings (user methods only), Meter setup, System check, USB

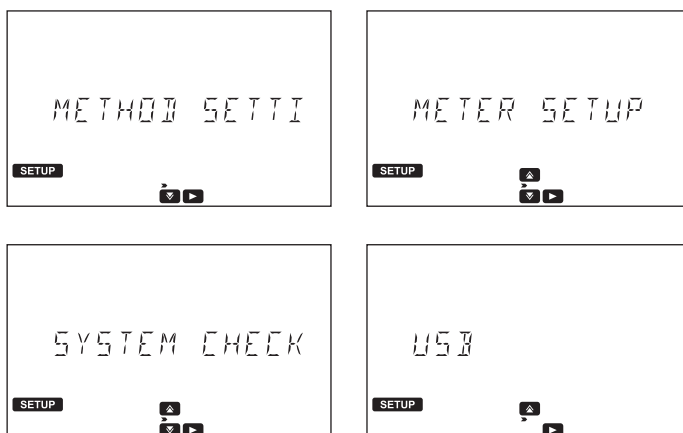

To return to the main screen press the **SETUP** key.

### 7.1. METER SETUP

Press the  $\blacktriangle$  or  $\blacktriangledown$  key to select METER SETUP, press the  $\blacktriangleright$  key to enter the menu.

METER SETUP allows users to modify the meter's general functionality, these settings do not affect the measurement.

#### 7.1.1. FAVORITE METHODS

Option: On or Off

When this option is On methods can be marked as favorites. Favorite methods are easily accessible on the main screen by pressing the  $\blacktriangle$  key, see User Methods section for more information. Up to 30 methods can be marked as favorites.



#### 7.1.2. AUTOMATIC LOG

Option: On or Off

When this option is On, measurements are automatically saved in the log. When enabled the  $\square$  tag is displayed on the main screen. When this option is Off, measurements can be added to the log by pressing the **LOG** key.



### 7.1.3. METER ID

Option: 0000 to 9999

Press **EDIT** to set a meter ID.

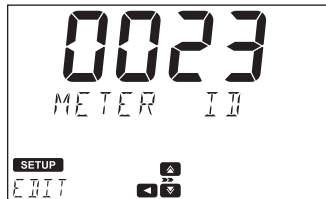

Press the ◀ or ▶ key to highlight the digit to be modified. Press the ▲ or ▼ key to set the desired value. Press **CFM** to confirm the meter ID or **CLR** to return to the setup menu without saving.

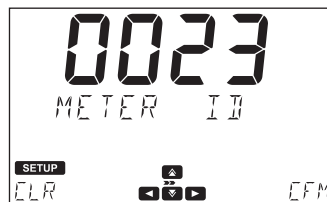
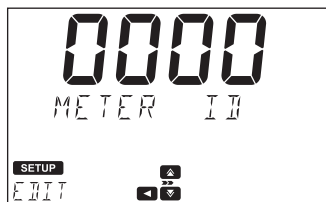

### 7.1.4. SAMPLE ID

Option: On or Off

If this option is On the user will be prompted to enter a sample ID when a measurement is saved.

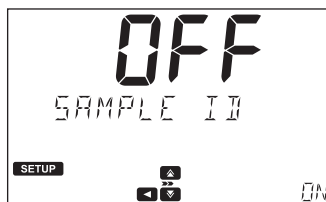

### 7.1.5. BEEPER

Option: Key Press, Errors, Timers

Press the ▶ key to access the beeper submenu.

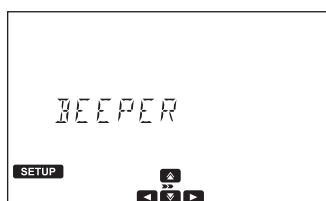

#### Key press

Option: On or Off

If this option is On, a short beep is heard every time an active key is touched, a long beep is heard every time an inactive key is touched.



## Errors

Option: On or Off

If this option is On, a long beep is heard every time an error occurs.



## Timers

Option: On or Off

If this option is On, a long beep is heard when a timer reaches "00:00".



### 7.1.6. LCD CONTRAST

Option: 0 to 7

Press **EDIT** to change the display's contrast.

Press the  $\blacktriangle$  or  $\blacktriangledown$  key to increase or decrease the value.

Press **CFM** to save the value or **CLR** to return to the setup menu without saving.



### 7.1.7. LETTER SCROLL

Option: Letter scroll or Word scroll

Press **EDIT** to change the scrolling text. Press the  $\blacktriangle$  or  $\blacktriangledown$  key to select the desired type.

Press **CFM** to save the type or **CLR** to return to the setup menu without saving.



### 7.1.8. CSV FIELD SEPARATOR

Option: Comma (,) or Semicolon (;)

Press the ► key to access the submenu.

Press **EDIT** to change the type. Press the ▲ or ▼ key to select the field separator.

Press **CFM** to confirm the field separator or **CLR** to return to the setup menu without saving.



### 7.1.9. DATE & TIME SETTING

Option: Time format, Date format, Set date, Set time

Press the ► key to access the date and time submenu.



#### Time Format

Option: 24 h or 12 h

Press **EDIT** to change the time format.

Press the ▲ or ▼ key to select the desired time format.

Press **CFM** to confirm the time format or **CLR** to return to the previous screen without saving.

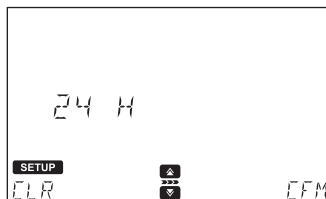

#### Date Format

Option: DD/MM/YYYY, MM/DD/YYYY, YYYY/MM/DD

Press **EDIT** to change the date format.

Press the ▲ or ▼ key to select the desired date format.

Press **CFM** to confirm the date or **CLR** to return to the previous screen without saving.

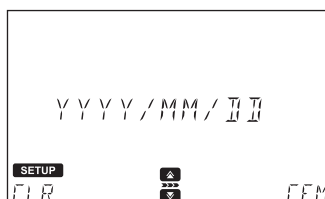
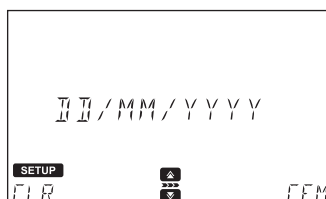

### Set Date

Press **EDIT** to modify the date.

Press the ◀ or ▶ key to highlight the digit to be modified. Press the ▲ or ▼ key to set the desired value.

Press **CFM** to save the date or **CLR** to return to the previous screen without saving.

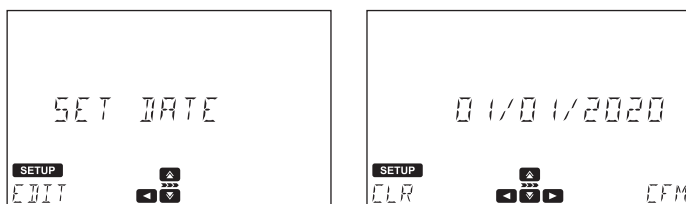

### Set Time

Press **EDIT** to modify the time.

Press the ◀ or ▶ key to highlight the digit to be modified. Press the ▲ or ▼ key to set the desired value.

Press **CFM** to save the time or **CLR** to return to the previous screen without saving.

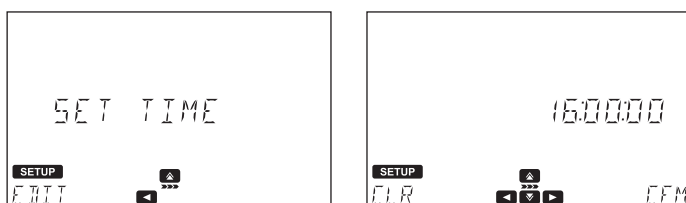

#### 7.1.10. CUVETTE DETECTION

**Option: On or Off**

If this option is On, automatic cuvette detection is enabled.

If the wrong cuvette is used an error message will be displayed.

If this option is Off, the indicated cuvette must be used with the factory methods to get a valid measurement.



#### 7.1.11. AUTO OFF

**Option: Off, 5, 10, 30, 60 minutes**

If there is no interaction between the user and the instrument for the set amount of time, the instrument will automatically turn off to preserve the battery.

If the auto off is set to Off and the power adapter is removed, the meter will auto off after 60 minutes unless the power adapter is reconnected.

Press **EDIT** to modify value.

Press the ▲ or ▼ key to select the desired value.

Press **CFM** to confirm the auto off or **CLR** to return to the setup menu without saving.

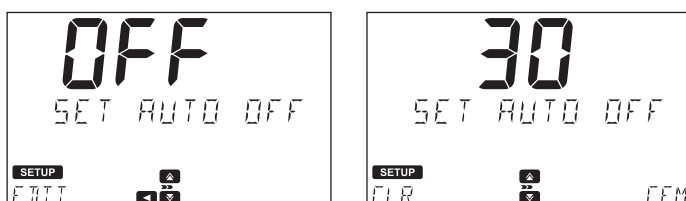



### 7.1.12. FACTORY RESET

Press **CFM** to reset the instrument to factory settings.

Press **YES** to continue or **NO** to return to the meter setup menu.

**Note:** Back up all data before you continue to prevent accidental data loss. Once this process has been started, it cannot be interrupted or reversed.

The meter will restart when the factory restart is complete.



### 7.1.13. RESET CONFIGURATION

Press **CFM** to reset all modifications made to the meter's configuration.

Press **YES** to continue or **NO** to return to the meter setup menu.



## 7.2. SYSTEM CHECK

Press the **▲** or **▼** key to select system check, press the **▶** key to enter the menu.

System check allows users to view information about the instrument and perform self diagnostic tests.

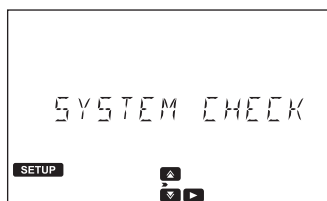

### 7.2.1. SYSTEM INFO

Press the **▶** key to access the system info menu.

Press the **▲** or **▼** key to scroll instrument's serial number, firmware version and baseboard version.

Press the **◀** key to return to the system check menu.

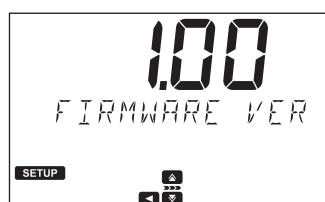
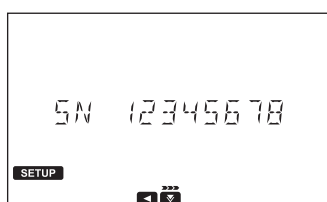
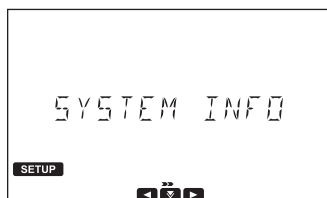

### 7.2.2. UPGRADE

Press **CFM** to update the firmware.

Insert a USB flash drive containing the update file into the port on the rear of the meter.

All data will be lost when the firmware is updated. Press the ◀ key to return to menu or the ▶ key to continue.



### 7.2.3. LAMP CHECK

To perform a diagnostic check on the lamp, press **CFM**. If the lamp passes, the "PASS" message is displayed on the lower left side of the display.

Press the ◀ key to return to the system check menu.

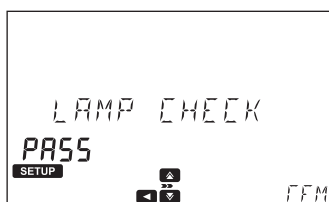

### 7.2.4. LAMP HISTORY

Press the ▶ key to view the number of hours the lamp has been running.

Press **RESET** to restart the counter. This should be performed after replacing the lamp.

Press the ◀ key to return to the system check menu.



### 7.2.5. WAVELENGTH CHECK

Press **CFM** to start the analysis.

Insert the zero cuvette and press **ZERO**.

Insert the holmium oxide glass filter and press **READ**.

Once the measurement is complete use the ◀ or ▶ key to view the results. The wavelengths corresponding to the found peaks will be displayed on the lower left side of the screen.

Press **EXIT** to return to the menu.



### 7.3. USB

Press the **▲** or **▼** key to select USB, press the **▶** key to enter the menu.  
Use this menu to import factory methods, import or export user methods and export logs.

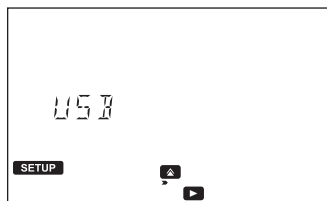

#### 7.3.1. METHODS

**Option: Factory methods, User methods**

Press the **▶** key to access the methods submenu.  
Press the **▲** or **▼** key to scroll through the options.



#### Factory Methods

**Option: Import all**

Press the **▶** key, "IMPORT ALL" will be displayed. Insert a USB flash drive containing the factory methods and press **CFM**. The process will start automatically, the display will show the progress. To avoid data corruption, do not remove the USB flash drive until the file transfer is complete.

Press the **◀** key to return to the Factory Methods submenu.



## User Methods

### Option: Import all or Export all

Press the  $\blacktriangle$  key. "IMPORT ALL" will be displayed. Press the  $\blacktriangle$  or  $\blacktriangledown$  key to select the desired option. Insert a USB flash drive and press **CFM**. The process will start automatically, the display will show the progress. To avoid data corruption, do not remove the USB flash drive until the file transfer is complete.

Exported methods can be transferred to other meters.

Press the  $\blacktriangleleft$  key to return to the METHODS menu.



## 7.3.2. REPORTS

### Option: By sample ID (if enabled), By method ID, By date

Press the  $\blacktriangleright$  key to access the reports submenu.

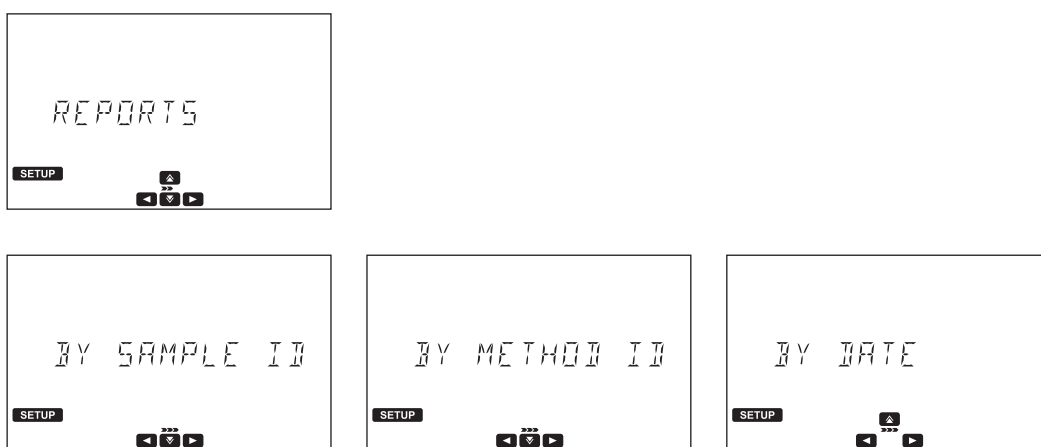

### By Sample ID (if enabled)

Press the  $\blacktriangleright$  key. The select Sample ID screen is shown.

Press **EDIT** to edit the sample ID. Press the  $\blacktriangleleft$  or  $\blacktriangleright$  key to highlight the digit to be modified. Press the  $\blacktriangle$  or  $\blacktriangledown$  key to set the desired value.

Press **CFM** to confirm the Sample ID or **CLR** to return to the previous screen without saving.

Press the  $\blacktriangledown$  key to select the file type. The selected file type will be displayed on the screen.

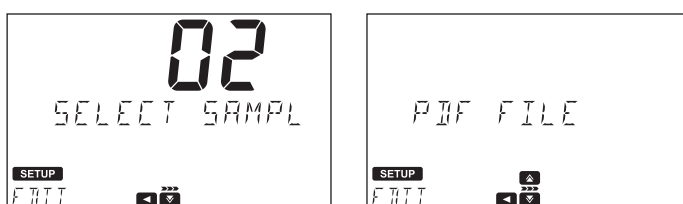

Press **EDIT** to change the file type. Press the ▲ or ▼ key to select the file type. Press **CFM** to confirm the file type or **CLR** to return to the previous screen without saving.

Press the ▼ key to continue. The "CREATE" message will be displayed.

Press **CFM** to export the file. To avoid data corruption, do not remove the USB flash drive until the file transfer is complete.

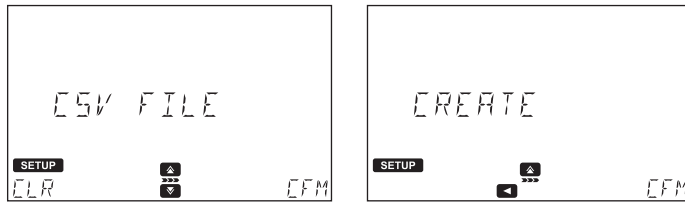

**Note:** If no USB flash drive is connected users will be prompted to connect the flash drive.

### By Method ID

Press the ► key. The select Method ID screen is shown.

Press **EDIT** to edit the method ID. Press the ◀ or ▶ key to highlight the digit to be modified.

Press the ▲ or ▼ key to set the desired value.

Press **CFM** to confirm the Method ID or **CLR** to return to the previous screen without saving.

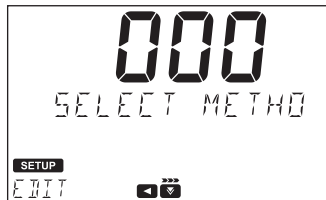

Press the ▼ key to select the file type. The selected file type will be displayed on the screen.

Press **EDIT** to change the file type. Press the ▲ or ▼ key to select the file type. Press **CFM** to confirm the file type or **CLR** to return to the previous screen without saving.

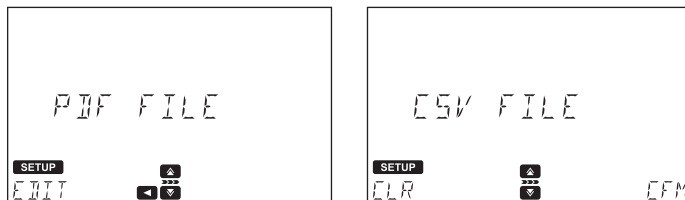

Press the ▼ key to continue. The "CREATE" message will be displayed. Press **CFM** to export the file.

To avoid data corruption, do not remove the USB flash drive until the file transfer is complete.



**Note:** If no USB flash drive is connected users will be prompted to connect the flash drive.

### By Date

Press the **▶** key. The Start Date screen is shown.

Press **EDIT** to edit the start date. Press the **◀** or **▶** key to highlight the digit to be modified.

Press the **▲** or **▼** key to set the desired value.

Press **CFM** to confirm the start date value or **CLR** to return to the previous screen without saving.

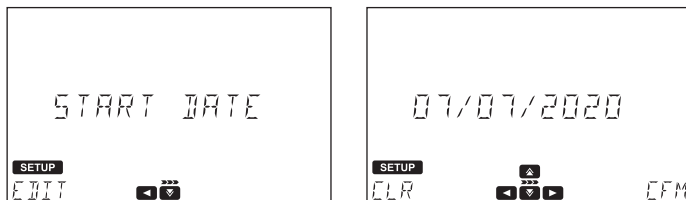

Press the **▼** key to select the end date.

Press **EDIT** to edit the end date. Press the **◀** or **▶** key to highlight the digit to be modified.

Press the **▲** or **▼** key to set the desired value.

Press **CFM** to confirm the value end date or **CLR** to return to the previous screen without saving.

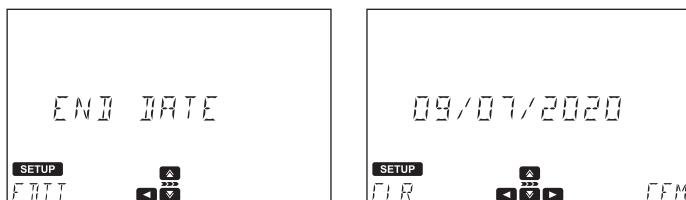

Press the **▼** key to select the file type. The selected file type will be displayed on the screen.

Press **EDIT** to change the file type. Press the **▲** or **▼** key to select the file type. Press **CFM** to confirm the file type or **CLR** to return to the previous screen without saving.

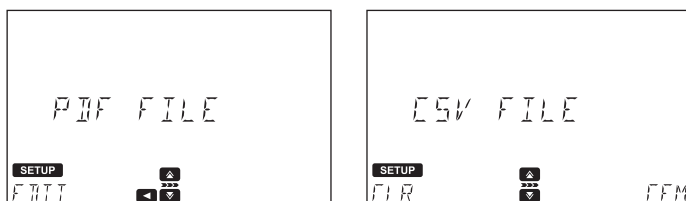

Press the **▼** key to continue. The "CREATE" message will be displayed.

Press **CFM** to export the file. To avoid data corruption, do not remove the USB flash drive until the file transfer is complete.

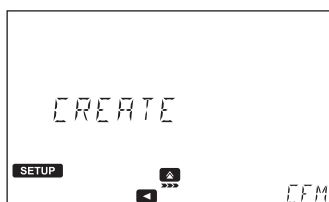

**Note:** If no USB flash drive is connected users will be prompted to connect the flash drive.

### 7.3.3. CONNECT TO PC

Once the instrument is connected reports and user methods can be imported or exported directly from the unit. Press **CFM** to enable the connection. The USB PC tag and the message "CONNECTED TO PC" will be displayed. Use a file manager (such as Windows Explorer or Mac Finder) to move the files to/from the meter/PC. The meter will appear as a removable disk. To avoid data corruption, do not remove the USB cable until the file transfer is complete. Press **STOP** to disconnect the instrument.



## 7.4. METHOD SETTINGS (USER METHODS ONLY)

Method Settings allows users to modify the settings and calibration curve for to the selected user method. These settings affect the measurement.

### 7.4.1. MEASUREMENT UNIT

Option: None, %T, ABS, ppm, mg/L, ppt, °f, °e, ppb, meq/L, µg/L, PCU, Pfund, pH, mV, dKH, °dH, meq/kg  
Press **EDIT** to select the measurement unit.

Press the ▲ or ▼ key to select the unit.

Press **CFM** to confirm the unit or **CLR** to return to the method settings menu without saving.



### 7.4.2. NUMBER OF WAVELENGTHS (except for ABS or %T methods)

Option: 1 to 5

Press **EDIT** to change the number of wavelengths.

Press the ▲ or ▼ key to select the number of wavelengths.

Press **CFM** to confirm the number of wavelengths or **CLR** to return to the method settings menu without saving.



### 7.4.3. WAVELENGTH SETTINGS

Option: 340 to 900 nm

Press **EDIT** to modify the wavelength.

Press the ◀ or ▶ key to highlight the digit to be modified. Press the ▲ or ▼ key to set the desired value.

Press **CFM** to confirm the set wavelength or **CLR** to return to the method settings menu without saving.

*Note: Press the ▼ key to view additional wavelengths (if enabled).*

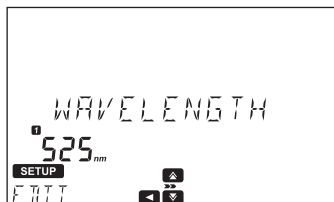

### 7.4.4. DECIMALS

Option: 0 to 3

Resolution for absorbance (Abs) and transmittance (%T) are fixed and cannot be modified.

Press **EDIT** to select the number of decimals (xxxx, xxx.x, xx.xx or x.xxx).

Press the ▲ or ▼ key to select the number of decimals.

Press **CFM** to confirm the number of decimals or **CLR** to return to the method settings menu without saving.



### 7.4.5. DILUTION FACTOR

Option: 001 to 100

This allows samples with high concentrations that are outside the measurement range to be measured. If the sample is not diluted enter a factor of 001.

Press **EDIT** to modify the dilution factor.

Press the ◀ or ▶ key to highlight the digit to be modified. Press the ▲ or ▼ key to set the desired value.

Press **CFM** to confirm the dilution factor or **CLR** to return to the method settings menu without saving.



### 7.4.6. VIAL TYPE

Option: 10 mm, 13 mm, 16 mm, 22 mm, 50 mm

Press **EDIT** to select the vial type.

Press the ▲ or ▼ key to select the vial.



Press **CFM** to confirm the vial type or **CLR** to return to the method settings menu without saving.

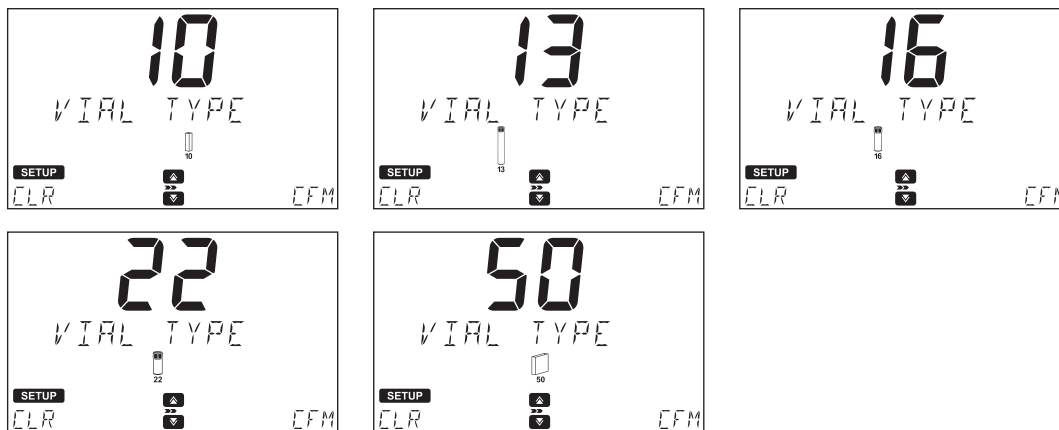

### 7.4.7. NUMBER OF TIMERS

Option: 0 to 5

Press **EDIT** to select the number of timers. Press the  $\blacktriangle$  or  $\blacktriangledown$  key to select the number of timers.

Press **CFM** to confirm the number of timers or **CLR** to return to the method settings menu without saving.

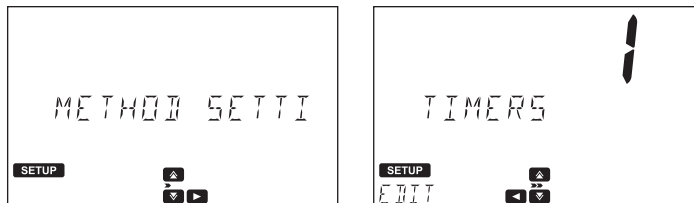

### 7.4.8. TIMER SETTING

Option: 00:00 to 59:59

Press **EDIT** to modify the time.

Press the  $\blacktriangleleft$  or  $\blacktriangleright$  key to highlight the digit to be modified. Press the  $\blacktriangle$  or  $\blacktriangledown$  key to set the desired value.

Press **CFM** to confirm the time or **CLR** to return to the method settings menu without saving.

Press **ENTER** to modify the timer name. Press **EDIT** to modify the name.

Press the  $\blacktriangleleft$  or  $\blacktriangleright$  key to highlight the character to be modified. Press the  $\blacktriangle$  or  $\blacktriangledown$  key to set the desired character.

Press **CFM** to confirm the timer name or **CLR** to return to the method settings menu without saving.

Press **EXIT** to return to the timer screen.

**Note:** Press the  $\blacktriangledown$  key to view additional timers (if enabled).



### 7.4.9. MULTI WAVELENGTH FORMULA

This option is only available if the selected method uses more than 1 wavelength.  
The final result can be calculated using equations with editable coefficients.



#### Equations:

The following equations can be used to calculate the final result.

Formula Sum  $P_1 A_1 + P_2 A_2 + P_3 A_3 + P_4 A_4 + P_5 A_5$

Formula Fraction  $C = \frac{P_1 A_1 + P_2 A_2 + P_3 A_3 + P_4 A_4 + P_5 A_5}{Q_1 A_1 + Q_2 A_2 + Q_3 A_3 + Q_4 A_4 + Q_5 A_5 + Q_6}$

Formula A1  $C = P_1 A_1$

Formula A2  $C = P_2 A_2$

Formula A3  $C = P_3 A_3$

Formula A4  $C = P_4 A_4$

Formula A5  $C = P_5 A_5$

C = Concentration

A<sub>1</sub> to A<sub>5</sub> = Absorbance at specified wavelength

P<sub>1</sub> to P<sub>5</sub> and Q<sub>1</sub> to Q<sub>6</sub> = Factors

Press **EDIT** to select the equation. Press the  $\blacktriangle$  or  $\blacktriangledown$  key to select the equation.

Press **CFM** to save the selection or **CLR** to return to the method settings.



**Note:** The multiwavelength formula is not available for ABS and %T unit selected.



#### Factors

The meter will only display and use the factor needed for the selected equation.

Press the  $\blacktriangle$  or  $\blacktriangledown$  key to select the factor.

Press **EDIT** to modify the value.

Press the  $\blacktriangleleft$  or  $\blacktriangleright$  key to highlight the digit to be modified. Press the  $\blacktriangle$  or  $\blacktriangledown$  key to set the desired value.

To shift the number (along with the decimal point) to the right use the ◀ key to highlight the digit furthest to the left and press the ◀ key (i.e. 9.876 will become 09.87, then 009.8 and 0009).



To make the number negative use the ◀ key to highlight the digit furthest to the left and press the ▼ key to decrement the value.

To shift the number (along with the decimal point) to the left use the ▶ key to highlight the digit furthest to the right and press the ▶ key (i.e. -0009 will become -009.8, then -09.87 and -9.876). This can be done as long as there are leading zeros available.



The digit furthest to the left takes values from -9 to 9 by pressing the ▲ or ▼ key, while the other digits are cyclic and take values from 0 to 9.

#### 7.4.10. CALIBRATION

**Option: Measure standards, Manual Abs entry**

Calibrations can contain up to 10 points.

*Note: This option is only available if a concentration unit is selected (i.e. mg/L, meq/kg, etc.). A calibration cannot be entered for methods using absorbance or % transmittance or multiwavelength methods. This option is only available for user methods. Factory methods have pre-programmed calibration curves based on the wavelength, cuvette type and reagent set.*



A calibration is required to run a new user method.

Press the ▶ key to enter the menu. Press the ▲ or ▼ key to select the desired option.

Press the ◀ key to return to the calibration menu.

Once a method has been calibrated the ✓ will be displayed on the main screen when the method is selected. If a user method has not been calibrated the error message "NOT CALIBRATED" will be displayed.

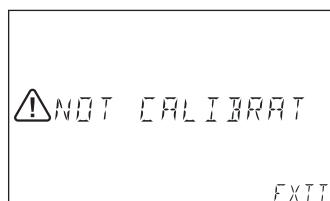

## Measure Standards

This allows users to measure the absorbance of standards with a known concentration. Up to 10 points can be used to calibrate the method.



Press **CFM** to start the calibration.

Press **EDIT** to modify the concentration for the first standard.

Press the ◀ or ▶ key to highlight the digit to be modified. Press the ▲ or ▼ key to set the desired value.

Press **CFM** to confirm the value or **CLR** to delete set value.

Press the ◀ key or the **SETUP** key to abort the calibration.

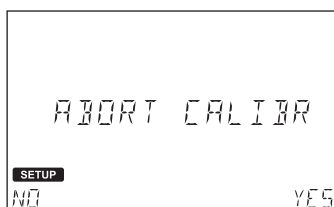

Press **NO** to return to the last calibration point screen or press **YES** to exit calibration.



Press **CFM** to continue.

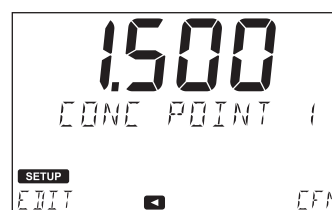

Insert the zero cuvette and press **ZERO**.

Insert the first standard and press **READ**.

Press **CFM** to save the value and continue or **REDO** to repeat the measurement.

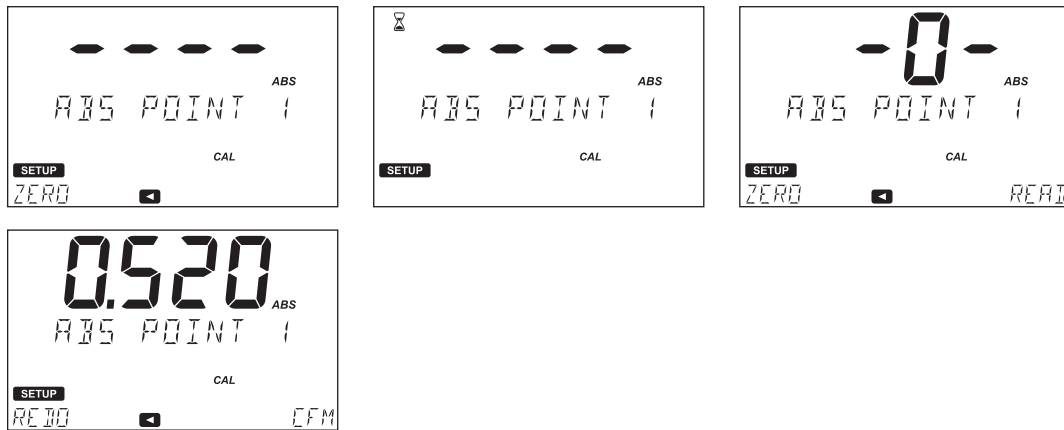

Press the ◀ key or the **SETUP** key to abort the calibration.

Press **DONE** to save and exit the calibration or **MORE** to add additional points.

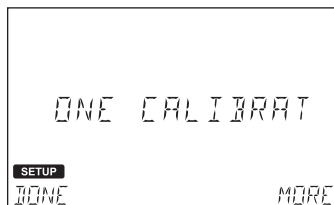

When wrong slope or offset occurred the meter will display an error message:

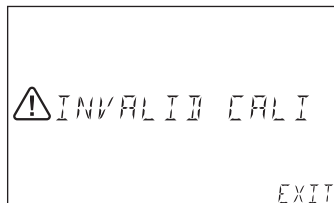

This procedure can be repeated until 10 calibration points have been added.

### Edit concentration point

### Measure ABS point

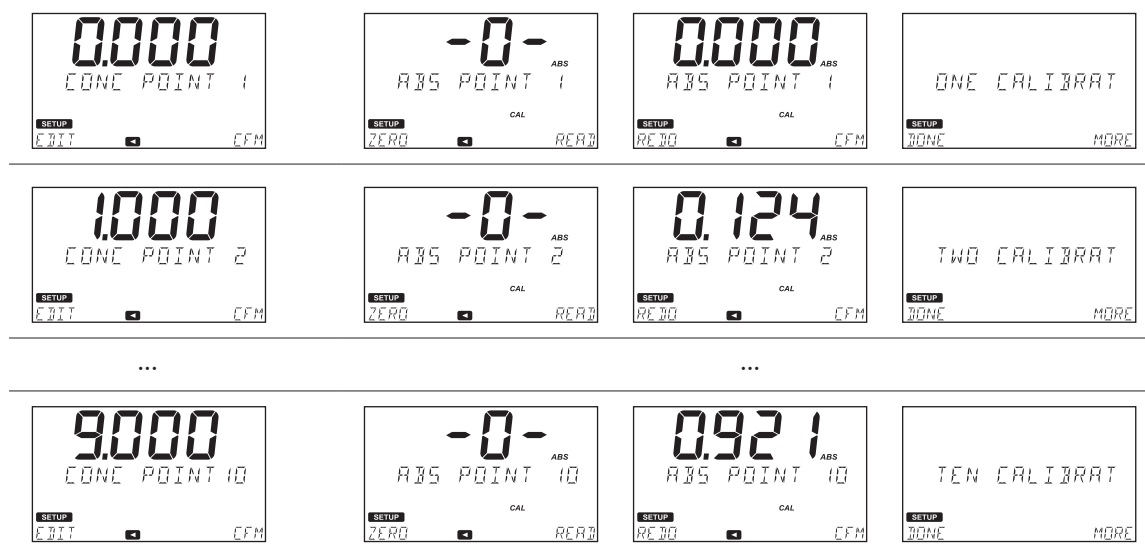

## Manual Abs Entry

This allows users to enter the absorbance of standards with a known concentration. Up to 10 points can be used to calibrate the method.

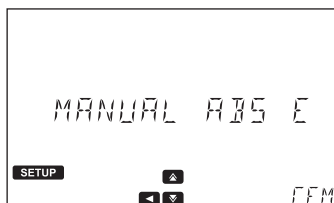

Press **CFM** to start the calibration.

Press **EDIT** to modify the concentration for the first standard.

Press the ◀ or ▶ key to highlight the digit to be modified. Press the ▲ or ▼ key to set the desired value.

Press **CFM** to confirm the value or **CLR** to delete set value. Press the ◀ key or the **SETUP** key to abort calibration.

Press **CFM** to continue.



Press **EDIT** to modify the absorbance for the first standard.

Press the ◀ or ▶ key to highlight the digit to be modified. Press the ▲ or ▼ key to set the desired value.

Press **CFM** to confirm the value or **CLR** to return to the method settings menu without saving. To set a negative abs value highlight the first digit and use the ▲ or ▼ key to select designed value.

Press **CFM** to save the value.



Press **DONE** to save and exit the calibration or **MORE** to add additional points.

This procedure can be repeated until 10 calibration points have been added.



## Edit concentration point

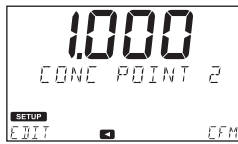
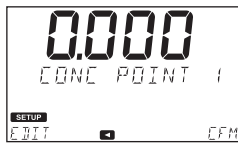

...

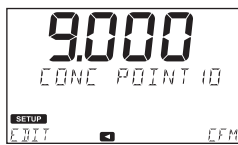

## Edit ABS point

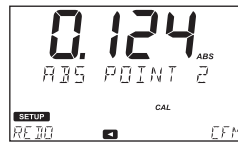
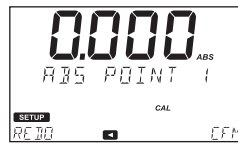

...

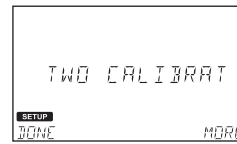
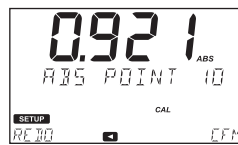

## View Calibration

Option: Slope, Offset, R-squared value

After a calibration has been completed the calibration data can be viewed using View Calibration. A linear regression is done by the instrument for the saved calibration points, the meter will apply the best straight-line fit to the calibration points.

Press **CFM** to view the calibration information.

Press the  $\blacktriangle$  or  $\blacktriangledown$  key to scroll through the options.



Press the  $\blacktriangleleft$  key to return to the previous screen.

## Delete Calibration

To delete a previous saved calibration use the  $\blacktriangle$  or  $\blacktriangledown$  key to select Delete Calibration.

Press **CFM** and **YES** to continue or **NO** to return to the Calibration menu.

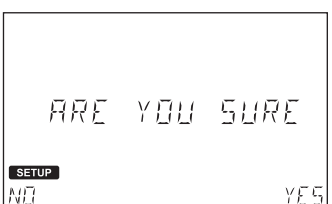

A new calibration is required before the method can be run.

## 8. SPARE PARTS

### 8.1. BATTERY REPLACEMENT

1. Loosen the screw using a Phillips head screwdriver at the bottom of the battery cover.

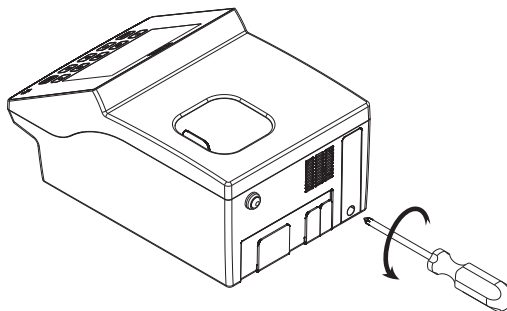

2. Remove the battery cover.

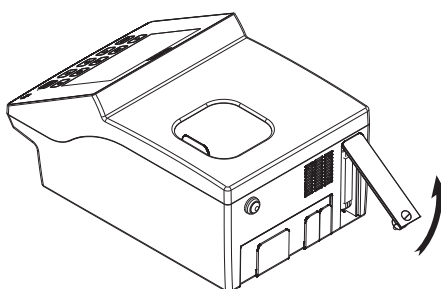

3. Pull the battery out.

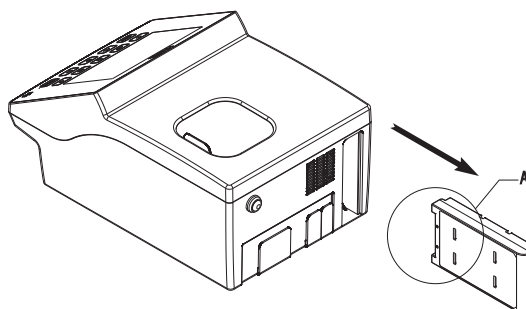

4. Always check the polarity when reinserting. The positive (+) sign should be on the top.

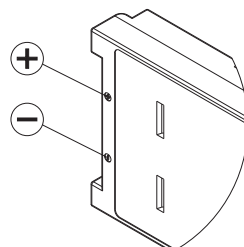



## 8.2. LAMP REPLACEMENT

**Warning:** Do not touch the pins or the quartz glass! Only hold the tungsten halogen lamp by the metal holder.

Ensure the instrument is off before continuing.

To remove the tungsten halogen lamp follow the steps below.

1. Remove the screw on the lamp cover using a Phillips head screwdriver. Remove the cover.

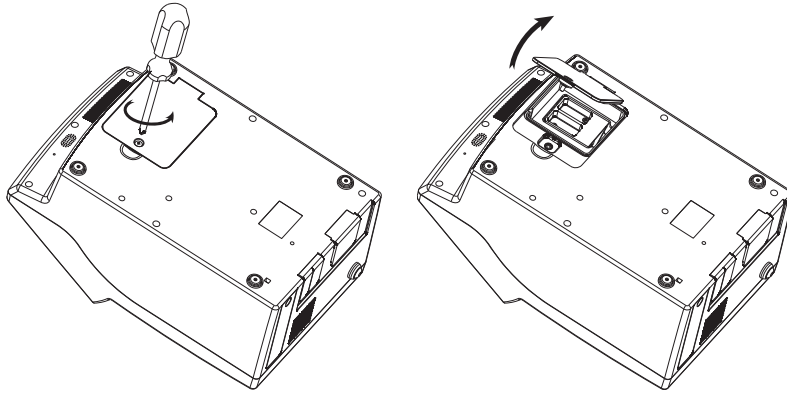

2. Remove the two bottom screws of the lamp holder.

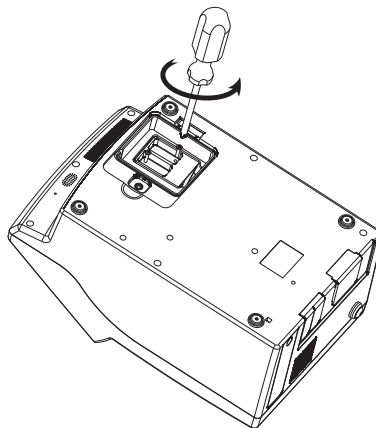

3. Slowly pull out the lamp cover.

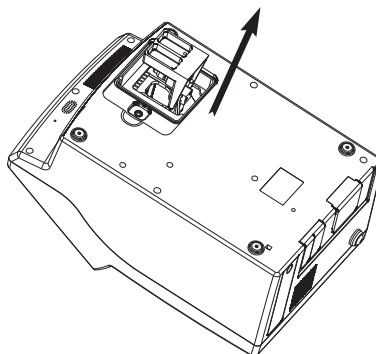

4. Disconnect the lamp cable, loosen the screw.

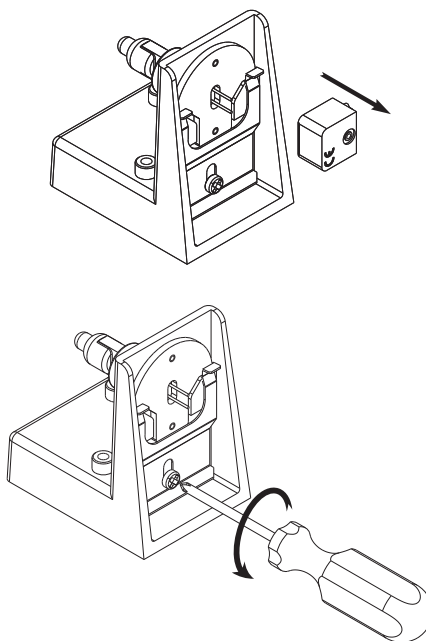

5. Slide down the metal support. Remove the lamp.

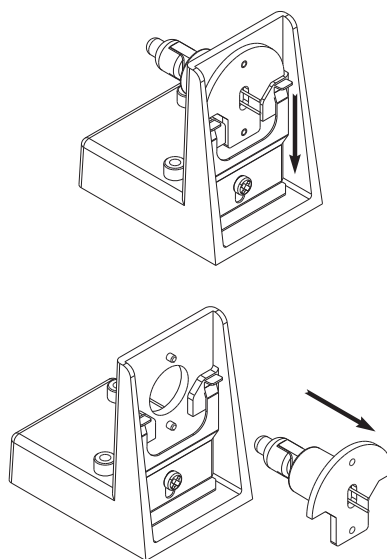

To replace the tungsten halogen lamp follow the steps below:

1. Insert the new lamp into the holder.

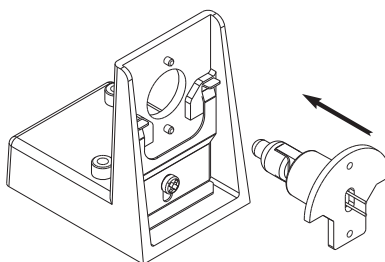

2. Slide up the metal support and tighten the screw.

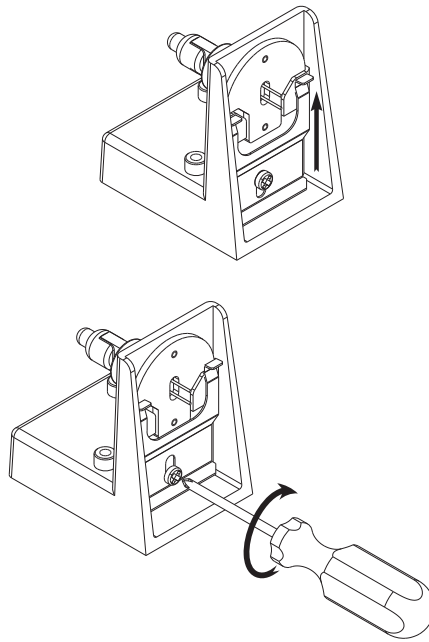

3. Connect the lamp cable.

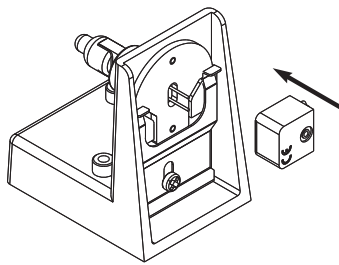

4. Align the lamp with the screw holes into the optical system, making sure the cable is not pinned between the optical system and holder.

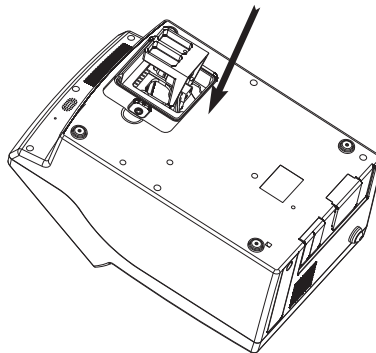

5. Tighten the two screws in the base of the lamp holder and push the power cable back into the instrument.

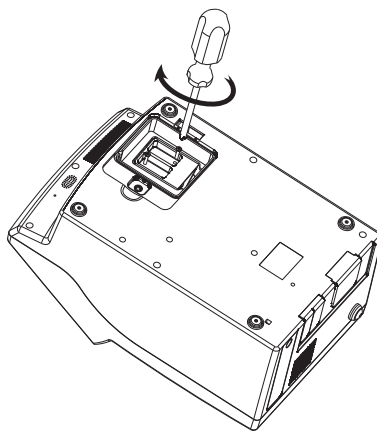

6. Place the cover and secure the screw.

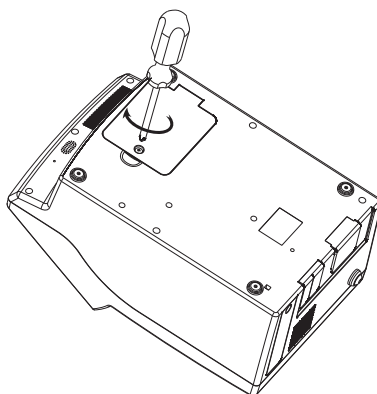
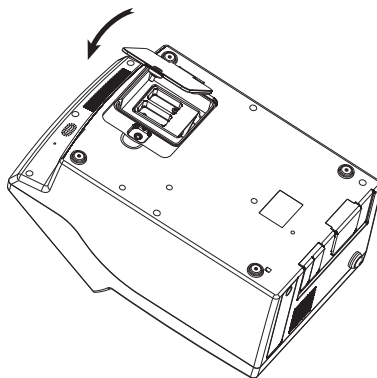

7. Power on the instrument.

## 9. WARNING & ERROR MESSAGES

### 9.1. WARNING MESSAGES

FACTORY METHODS FULL	The maximum number of factory methods has been reached.
USER METHODS FULL	The maximum number of user methods has been reached. At least 1 user method needs to be deleted before a new one can be created.
FAVORITE METHODS FULL	The maximum number of favorite methods has been reached.
METHOD MISSING OR CORRUPT	Corrupt method file.
FILE MISSING OR CORRUPT	Corrupt log file.
DISK FULL FACTORY	Factory partition full.
DISK FULL	The maximum number of logs have been saved. At least 1 log needs to be deleted before a new one can be created.
FLASH NOT SUPPORTED USB	Flash drive not supported.
FLASH REMOVED	The USB flash drive is missing or cannot be read.
LOG CORRUPTED	Corrupt log file.
NO LIGHT	The light source is not functioning properly. Replace the lamp or check the wiring.
LOW LIGHT	The instrument cannot adjust the light level. Please check that the sample does not contain any debris.
LIGHT HIGH	There is too much light to perform a measurement. Please check the preparation of the zero cuvette.
REFERENCE ERROR	There is a problem with the reference channel.
CLOSE THE LID	The lid is not properly closed.
INVERTED CUVETTES	The sample and the zero cuvettes are were measured in the wrong order or there is a problem with the cuvette preparation.
WRONG OR MISSING CUVETTE	Wrong cuvette inserted. The cuvette does not match the one specified in the method.
NOT CALIBRATED	A calibration is required before a user method can be used.
INVALID CALIBRATION	The calculated slope for the calibration curve is outside of allowed range. Please repeat the calibration.
HIGH TEMPERATURE	The internal temperature is higher then 55 °C.
LOW TEMPERATURE	The internal temperature is lower then 0 °C.
LAMP OLD - REPLACE SOON	The lamp life is over recommended maximum period. Consider replacing the lamp.

## 9.2. ERROR MESSAGES

These types of events are continuously monitored and if one or more occurred it will put the instrument in ERROR mode to avoid unpredictable behavior.



The "Err" is displayed on LCD, followed by the internal code of the error. This screen will block the access to the other screens. If a system error occurs, contact Hanna<sup>®</sup> Technical Support and provide the displayed code.

## PART II. FACTORY METHODS





## 1. COLLECTING & MEASURING SAMPLES AND REAGENTS

### 1.1. PROPER USE OF AUTOMATIC FIXED-VOLUME PIPETTES

For adding the exact amount of sample or liquid reagent to the cuvette or vial it is recommended to use automatic or a class A volumetric pipette. Hanna Instruments® offers a variety of fixed volume pipettes (see Accessories section for more information).

Proper use of automatic fixed-volume pipette:

1. Attach the pipette tip. Press the button down to the first stop.
2. Immerse the pipette tip in the liquid approximately 2-3 mm.
3. Slowly let the button move back to the original position, wait 2 seconds.
4. Remove the pipette tip from the liquid.
5. To dispense the liquid, place the pipette tip on the inside wall of the container.
6. Slowly press the button down to the first stop.
7. Wait until all of the liquid has been dispensed.
8. Press the button down to the second stop, this will allow any remaining liquid to be dispensed.



### 1.2. PROPER USE OF SYRINGE

1. Push the plunger completely into the syringe and insert the tip into the solution.
2. Pull the plunger up until the lower edge of the seal is exactly on the mark for the desired volume.
3. Take out the syringe and clean the outside of the tip, ensuring that no drops are hanging from the tip.
4. Keeping the syringe in a vertical position, push the plunger down. The desired volume has been delivered.

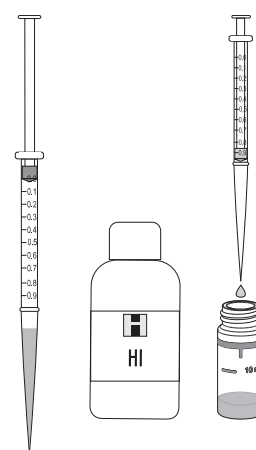

### 1.3. PROPER USE OF DROPPER BOTTLE

1. Tap the dropper on the table several times.
2. Remove the cap and wipe the outside of the tip with a cloth.
3. Keep the dropper bottle in a vertical position while dosing the reagent.

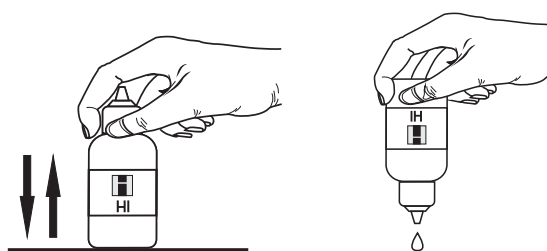

### 1.4. PROPER USE OF POWDER PACKET

1. Use scissors to open the powder packet.
2. Push the edges of the packet to form a spout.
3. Pour out the content of the packet.

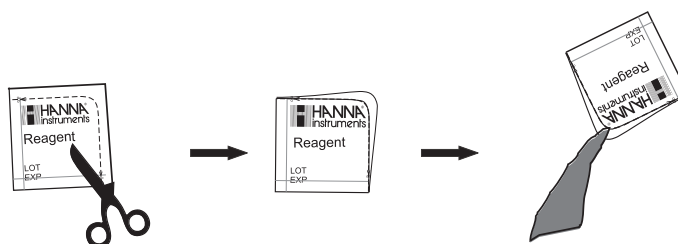

## 2. CUVETTE PREPARATION

Proper mixing is very important for reproducibility of the measurements. The proper mixing technique for each method is listed in the method procedure.

- (a) Invert the cuvette a couple of times or for a specified time: hold the cuvette in the vertical position. Turn the cuvette upside-down and wait for all of the solution to flow to the cap end, then return the cuvette to the upright vertical position and wait for all of the solution to flow to the bottom. This is one inversion. The correct speed for this mixing technique is 10 to 15 complete inversions in 30 seconds. This mixing technique is indicated with “invert to mix” and one of the following icons:

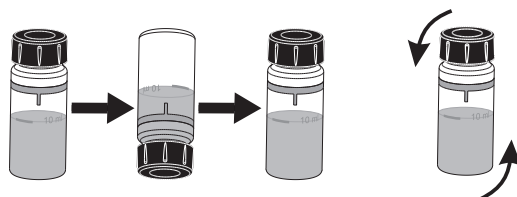

- (b) Shaking the cuvette, moving the cuvette up and down. The movement may be gentle or vigorous. This mixing technique is indicated with “shake gently” or “shake vigorously” and one of the following icons:

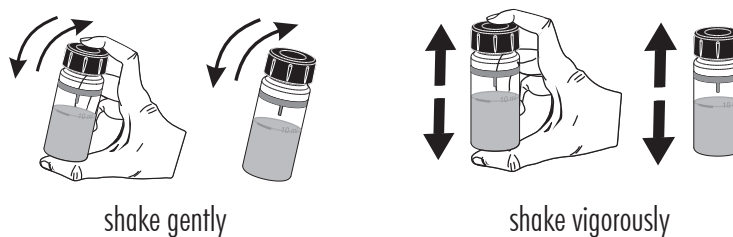

- (c) Swirl the cuvette gently to mix the solution. This mixing technique is indicated with one of the following icons:

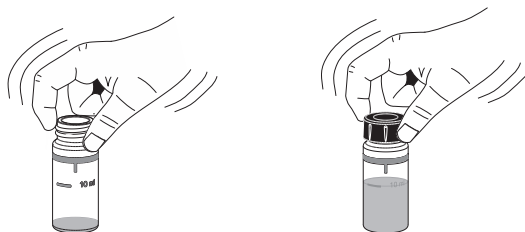

In order to avoid reagent leaking and to obtain more accurate measurements, close the cuvette first with the supplied High-Density Polyethylene (HDPE) plastic stopper and then the black cap.



Whenever the cuvette is placed into the measurement holder, it must be dry outside and free of fingerprints, oil and dirt. Wipe it thoroughly with [HI731318](#) microfiber cleaning cloth or a lint-free wipe prior to insertion.



Shaking the cuvette can generate bubbles in the sample, causing higher readings. To obtain accurate measurements, remove such bubbles by swirling or by gently tapping the cuvette.

Do not let the reacted sample stand too long after reagent is added. For best accuracy, respect the timings described in each specific method.

It is possible to take multiple readings in a row, but it is recommended to take a new zero reading for each sample and to use the same cuvette for zeroing and measurement when possible.

Discard the sample immediately after the reading is taken or the glass might become permanently stained.

All the reaction times reported in this manual are at 25 °C (77 °F). In general, the reaction time should be increased for temperatures lower than 20 °C (68 °F) and decreased for temperatures higher than 25 °C (77 °F).

## 3. METHOD LIST BY ID

ID	Method Name	ID	Method Name
001	Alkalinity	049	Manganese Low Range
002	Alkalinity, Marine	050	Manganese High Range
003	Aluminum	051	Maple Syrup
004	Ammonia Low Range	052	Molybdenum
005	Ammonia Low Range (13 mm Vial)	053	Nickel Low Range
006	Ammonia Medium Range	054	Nickel High Range
007	Ammonia High Range	055	Nitrate
008	Ammonia High Range (13 mm Vial)	056	Nitrate Chromotropic Acid (13 mm Vial)
009	Bromine	057	Nitrite, Marine Ultra Low Range
010	Calcium	058	Nitrite Low Range
011	Calcium, Marine	059	Nitrite High Range
012	Chloride	060	Nitrogen, Total Low Range (13 mm Vial)
013	Chlorine Dioxide	061	Nitrogen, Total High Range (13 mm Vial)
014	Chlorine, Free Ultra Low Range	062	Oxygen, Dissolved
015	Chlorine, Free Low Range (Powder Reagent)	063	Oxygen Scavengers (Carbohydrazide)
016	Chlorine, Free Low Range (Liquid Reagent)	064	Oxygen Scavengers (Diethylhydroxylamine) (DEHA)
017	Chlorine, Free High Range	065	Oxygen Scavengers (Hydroquinone)
018	Chlorine, Total Ultra Low Range	066	Oxygen Scavengers (Isoascorbic Acid)
019	Chlorine, Total Low Range (Powder Reagent)	067	Ozone
020	Chlorine, Total Low Range (Liquid Reagent)	068	pH
021	Chlorine, Total High Range	069	Phosphorus, Marine Ultra Low Range
022	Chlorine, Total Ultra High Range	070	Phosphate Low Range
023	Chromium (VI) Low Range	071	Phosphate High Range
024	Chromium (VI) High Range	072	Phosphorus, Acid Hydrolyzable (13 mm Vial)
025	Chemical Oxygen Demand Low Range EPA (13 mm Vial)	073	Phosphorus, Reactive Low Range (13 mm Vial)
026	Chemical Oxygen Demand Low Range Mercury Free (13 mm Vial)	074	Phosphorus, Reactive High Range (13 mm Vial)
027	Chemical Oxygen Demand Low Range ISO (13 mm Vial)	075	Phosphorus, Total Low Range (13 mm Vial)
028	Chemical Oxygen Demand Medium Range EPA (13 mm Vial)	076	Phosphorus, Total High Range (13 mm Vial)
029	Chemical Oxygen Demand Medium Range Mercury Free (13 mm Vial)	077	Potassium Low Range
030	Chemical Oxygen Demand Medium Range ISO (13 mm Vial)	078	Potassium Medium Range
031	Chemical Oxygen Demand High Range EPA (13 mm Vial)	079	Potassium High Range
032	Color of Water	080	Silica Low Range
033	Copper Low Range	081	Silica High Range
034	Copper High Range	082	Silver
035	Cyanide	083	Sulfate
036	Cyanuric Acid	084	Surfactants, Anionic
037	Fluoride Low Range	085	Zinc
038	Fluoride High Range	086	Chlorine Dioxide (Rapid)
039	Hardness, Calcium	087	Chromium (VI)/Total (13 mm Vial)
040	Hardness, Magnesium	088	Chemical Oxygen Demand Ultra High Range (13 mm Vial)
041	Hardness, Total Low Range	089	Iron (II) (Ferrous)
042	Hardness, Total Medium Range	090	Iron Total (13 mm Vial)
043	Hardness, Total High Range	091	Nitrite Low Range (13 mm Vial)
044	Hydrazine	092	Nitrite Medium Range (13 mm Vial)
045	Iodine	093	Surfactants, Anionic (13 mm Vial)
046	Iron Low Range	094	Surfactants, Nonionic (13 mm Vial)
047	Iron High Range	095	Surfactants, Cationic (13 mm Vial)
048	Magnesium	096	Iron (13 mm Vial)

## 4. METHOD PROCEDURES

### Alkalinity

#### SPECIFICATIONS

Range	0 to 500 mg/L (as CaCO <sub>3</sub> )
Resolution	1 mg/L
Accuracy	±5 mg/L ±5% of reading at 25 °C
Wavelength	610 nm
Cuvette type	22 mm diameter
Method	Bromocresol Green
Method ID	#001

#### REQUIRED REAGENTS

Code	Description	Quantity
HI775S	Alkalinity Reagent	1 mL
HI93755-53	Chlorine Removal Reagent	1 drop

#### REAGENT SETS

HI775-26 Reagents for 25 tests

For other accessories see Accessories section.

#### MEASUREMENT PROCEDURE

- Select the **Alkalinity** method using the procedure described in the Factory Methods section.

- Fill the cuvette with 10 mL of unreacted sample (up to the mark). Replace the plastic stopper and the cap.



10 mL

- Insert the cuvette into the holder and close the lid.

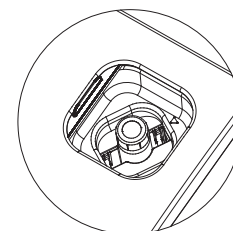

- Press **ZERO**. The display will show “-0-” when the meter is zeroed and ready for measurement.

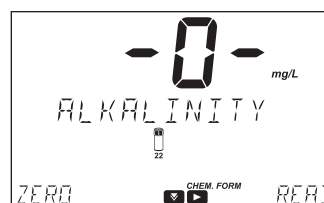
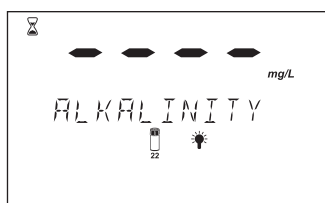
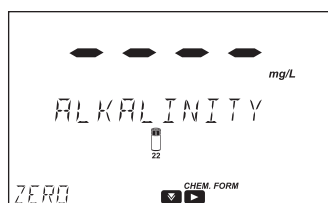

- Remove the cuvette.

- Add 1 mL of HI775S Alkalinity Reagent to the sample using a 1 mL syringe.

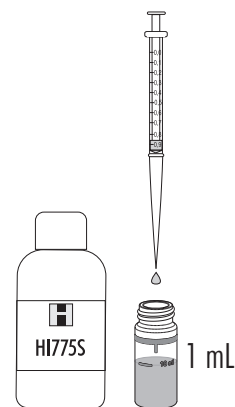

- Replace the plastic stopper and the cap. Invert 5 times.



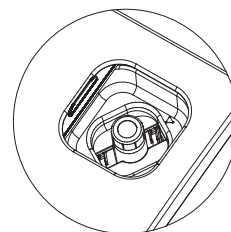

- Insert the cuvette into the holder and close the lid.

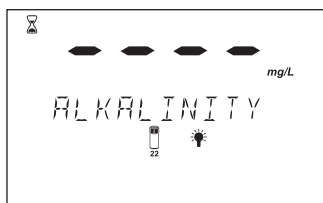
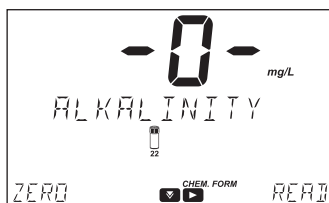

- Press **READ** to start the reading. The instrument displays the results in mg/L of calcium carbonate ( $\text{CaCO}_3$ ).



- Press the  key to view the wavelength, method ID, date and time.
- Press the  key to view the chemical formula.

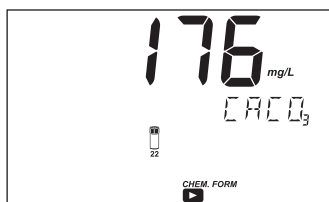

- Press the  key to return to the measurement screen.

## INTERFERENCES

Interference may be caused by:

- Chlorine must be absent. To remove the interference, add one drop of HI93755-53 Chlorine Removal Reagent to the unreacted sample

## Alkalinity, Marine

### SPECIFICATIONS

Range	0 to 300 mg/L (as CaCO <sub>3</sub> )
Resolution	1 mg/L
Accuracy	± 5 mg/L ± 5% of reading at 25 °C
Wavelength	610 nm
Cuvette type	22 mm diameter
Method	Bromocresol Green
Method ID	#002

### REQUIRED REAGENTS

Code	Description	Quantity
HI755S	Alkalinity Reagent	1 mL

### REAGENT SETS

HI755-26 Reagents for 25 tests  
For other accessories see Accessories section.

### MEASUREMENT PROCEDURE

- Select the **Alkalinity Marine** method using the procedure described in the Factory Methods section.

- Fill the cuvette with 10 mL of unreacted sample (up to the mark). Replace the plastic stopper and the cap.



10 mL

- Insert the cuvette into the holder and close the lid.

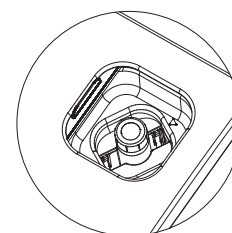

- Press **ZERO**. The display will show “-0-” when the meter is zeroed and ready for measurement.

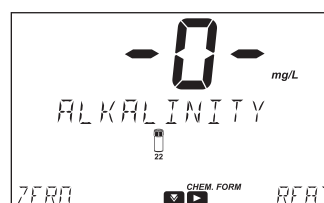
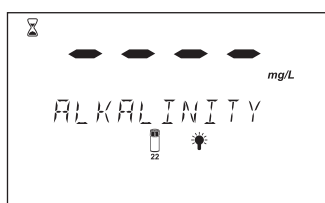
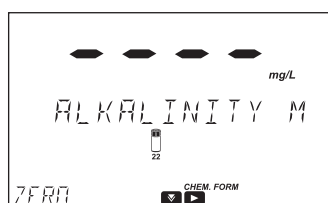

- Remove the cuvette.

- Add 1 mL of HI755S Alkalinity Reagent to the sample using a 1 mL syringe.

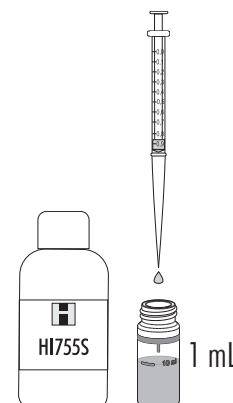

1 mL

- Replace the plastic stopper and the cap. Invert 5 times.



- Insert the cuvette into the holder and close the lid.

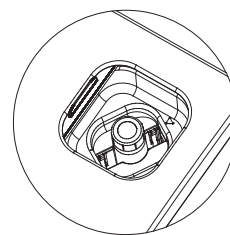

- Press **READ** to start the reading. The instrument displays the results in mg/L of calcium carbonate ( $\text{CaCO}_3$ ).

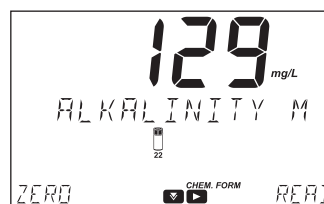
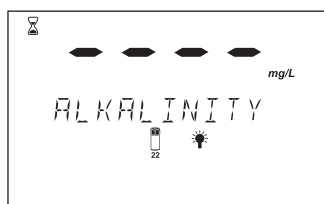
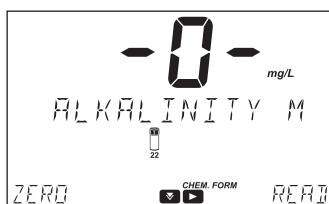

- Press the key to view the wavelength, method ID, date and time.
- Press the key to view the chemical formula.
- Press the key to convert the results to degree carbonate hardness (dKH).

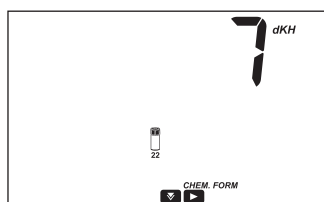
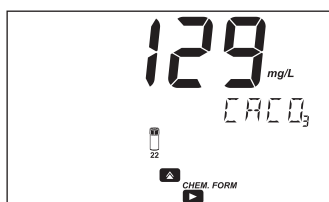

- Press the key to return to the measurement screen.



## Aluminum

### SPECIFICATIONS

Range	0.00 to 1.00 mg/L (as Al <sup>3+</sup> )
Resolution	0.01 mg/L
Accuracy	±0.04 mg/L ±4% of reading at 25 °C
Wavelength	530 nm
Cuvette type	22 mm diameter
Method	Adaptation of the Aluminon Method
Method ID	#003

### REQUIRED REAGENTS

Code	Description	Quantity
HI93712A-0	Aluminum Reagent A	1 packet
HI93712B-0	Aluminum Reagent B	1 packet
HI93712C-0	Aluminum Reagent C	1 packet

### REAGENT SETS

HI93712-01	Reagents for 100 tests
HI93712-03	Reagents for 300 tests

For other accessories see Accessories section.

### MEASUREMENT PROCEDURE

- Select the **Aluminum** method using the procedure described in the Factory Methods section.

- Fill a graduated beaker with 50 mL of sample.

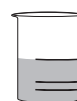

- Add one packet of **HI93712A-0** Aluminum Reagent A. Mix until completely dissolved.



- Add one packet of **HI93712B-0** Aluminum Reagent B. Mix until completely dissolved.



- Fill two cuvettes with 10 mL of sample (up to the mark).

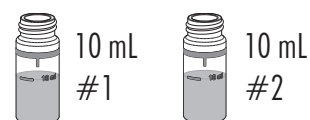

- Add one packet of **HI93712C-0** Aluminum Reagent C to one cuvette (#1). Replace the plastic stopper and the cap. Shake gently until completely dissolved. This is the blank.

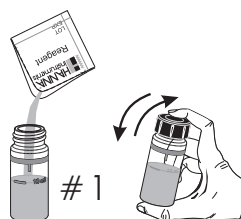

- Insert the first cuvette (#1) into the holder and close the lid.

# 1

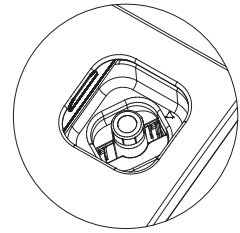

- Press the ◀ key to access the timer menu. Press **START** to start Timer 1, the display will show the countdown prior to the zero or wait 15 minutes.
- Press **ZERO**. The display will show “-0-” when the meter is zeroed and ready for measurement.

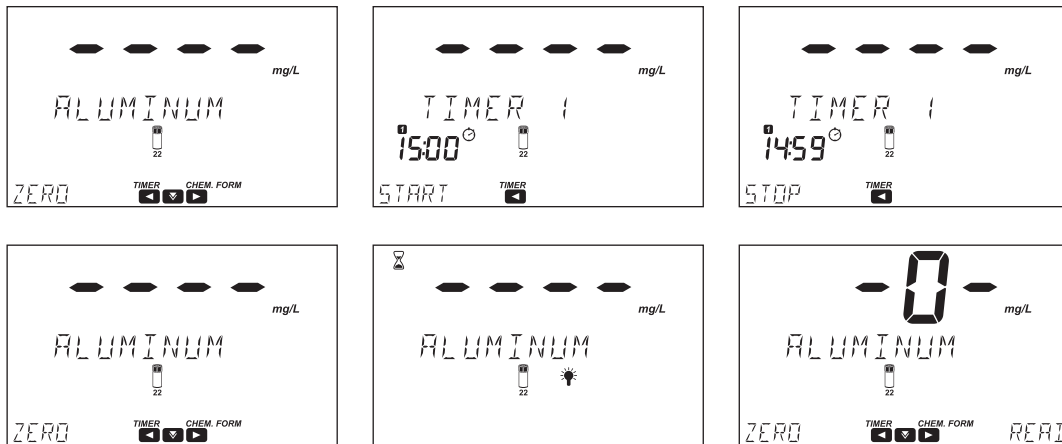

- Remove the blank and insert the second cuvette (#2) into the holder and close the lid.

# 2

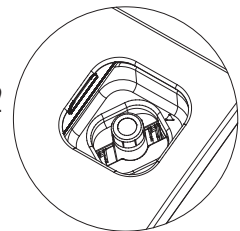

- Press **READ** to start the reading. The instrument displays the results in **mg/L** of aluminum ( $\text{Al}^{3+}$ ).

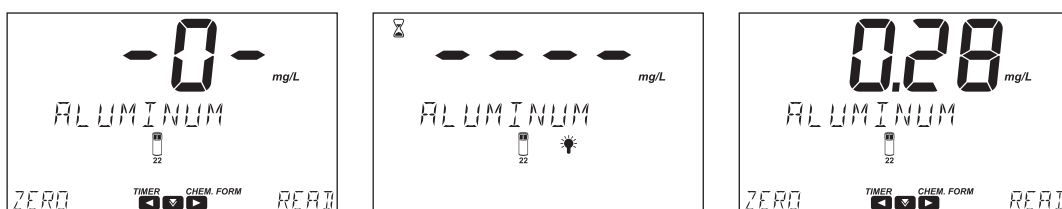

- Press the ▼ key to view the wavelength, method ID, date and time.
- Press the ▶ key to view the chemical formula.
- Press the ▼ key to convert the results to **mg/L** of aluminum oxide ( $\text{Al}_2\text{O}_3$ ).

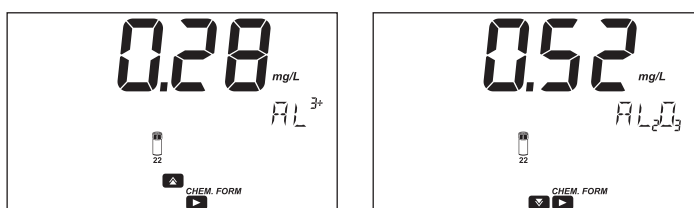

- Press the ▶ key to return to the measurement screen.

## INTERFERENCES

Interference may be caused by:

- Alkalinity above 1000 mg/L
- Phosphate above 50 mg/L
- Iron above 20 mg/L
- Fluoride must be absent. If the fluoride concentration is known, the aluminum concentration can be determined using the graph below:

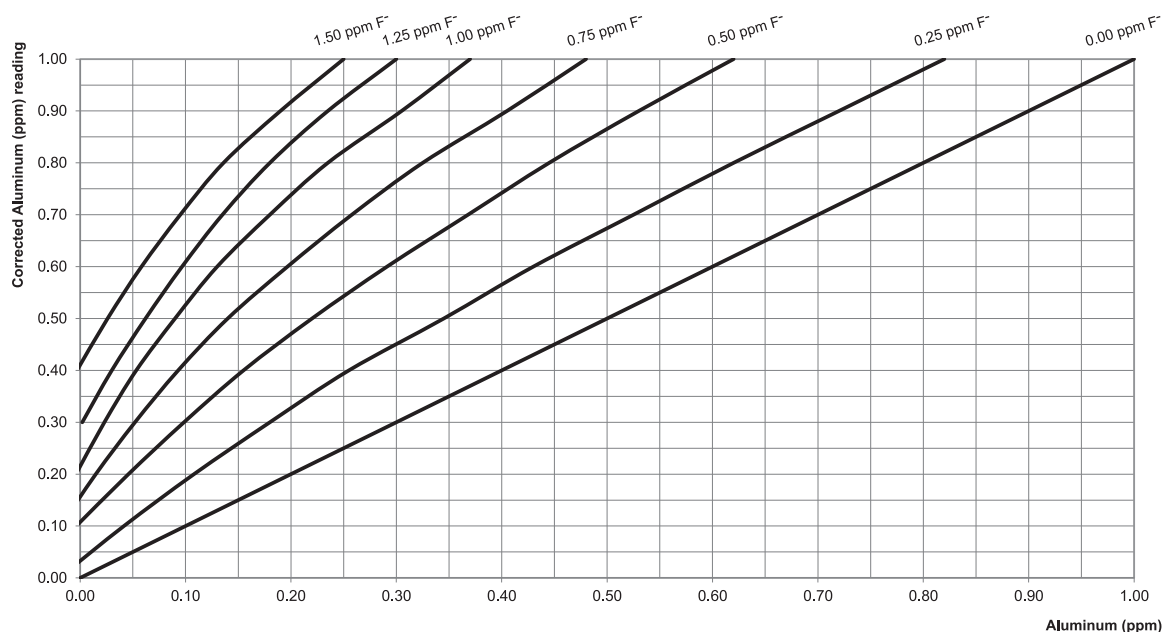

To determine the corrected aluminum concentration:

1. Follow the measurement procedure to obtain the aluminum concentration.
2. Locate the aluminum reading on x-axis.
3. Follow the line up, until it intersects the fluoride curve corresponding to the fluoride concentration in the sample.
4. From the intersection of the fluoride and aluminum line, follow the line to the left until it intersects the y-axis. This point corresponds to the corrected aluminum concentration in the sample.

Example: Aluminum reading on meter 0.40 ppm and fluoride content in sample 0.50 ppm, corrected aluminum concentration in sample is 0.75 ppm.

## Ammonia Low Range

### SPECIFICATIONS

Range	0.00 to 3.00 mg/L (as NH <sub>3</sub> -N)
Resolution	0.01 mg/L
Accuracy	±0.04 mg/L ± 4% of reading at 25 °C
Wavelength	425 nm
Cuvette type	16 mm diameter
Method	Adaptation of the ASTM Manual of Water and Environmental Technology, D1426 Nessler Method
Method ID	#004

### REQUIRED REAGENTS

Code	Description	Quantity
HI93700A-0	Ammonia Low Range Reagent A	4 drops
HI93700B-0	Ammonia Low Range Reagent B	4 drops

### REAGENT SETS

HI93700-01 Reagents for 100 tests

HI93700-03 Reagents for 300 tests

For other accessories see Accessories section.

### MEASUREMENT PROCEDURE

- Select the **Ammonia LR** method using the procedure described in the Factory Methods section.

- Fill the cuvette with 10 mL of unreacted sample (up to the mark). Replace the plastic stopper and the cap.



10 mL

- Insert the 16 mm cuvette adapter using the procedure described in the Cuvette & Vial Adapters section.
- Insert the cuvette into the adapter and close the lid.

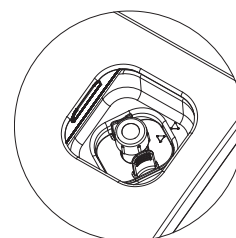

- Press **ZERO**. The display will show “-0-” when the meter is zeroed and ready for measurement.

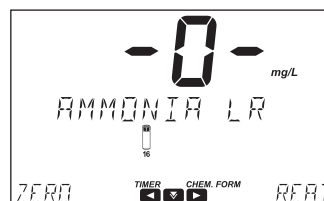
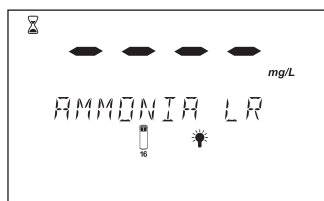
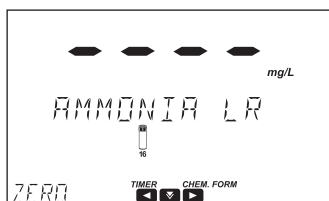

- Remove the cuvette.
- Add 4 drops of **HI93700A-0** Ammonia Low Range Reagent A. Replace the plastic stopper and the cap. Swirl to mix the solution.

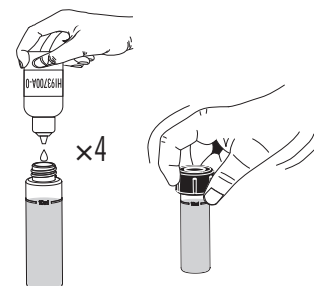

- Add 4 drops of **HI93700B-0** Ammonia Low Range Reagent B. Replace the plastic stopper and the cap. Swirl to mix the solution.

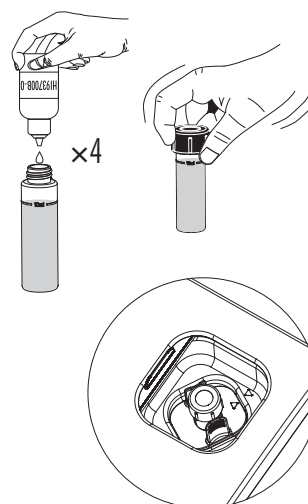

- Insert the cuvette into the holder and close the lid.

- Press the ◀ key to access the timer menu. Press **START** to start Timer 1, the display will show the countdown prior to measurement or wait 3 minutes and 30 seconds.
- Press **READ** to start the reading. The instrument displays the results in mg/L of ammonia nitrogen ( $\text{NH}_3\text{-N}$ ).

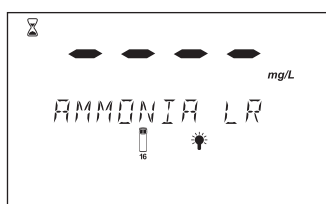
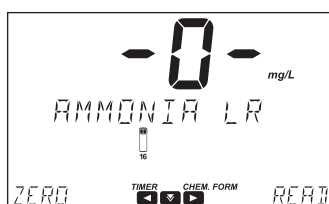
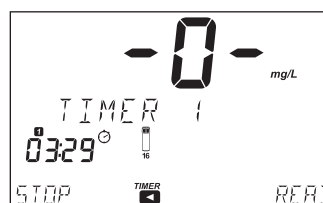
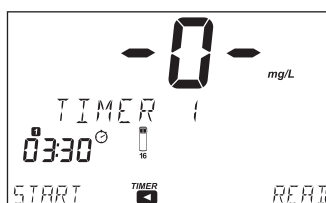
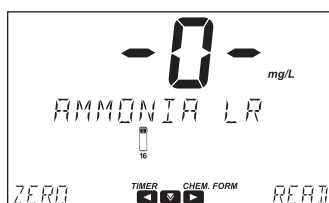

- Press the ▼ key to view the wavelength, method ID, date and time.
- Press the ► key to view the chemical formula.
- Press the ▲ key to convert the results to mg/L of ammonia ( $\text{NH}_3$ ) or ammonium ( $\text{NH}_4^+$ ).

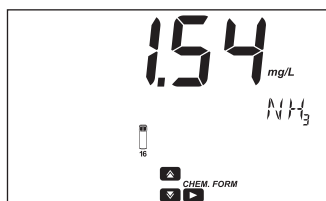
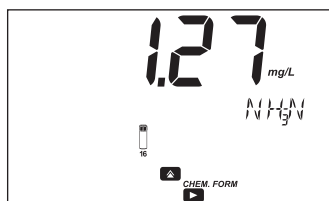

- Press the ► key to return to the measurement screen.

## INTERFERENCE

Interference may be caused by:

- Hardness above 1 g/L
- Iron
- Sulfide may cause turbidity
- Organic compounds like acetone above 0.1%, alcohols, aldehydes, aliphatic and aromatic amines, chloramines, glycine, or urea above 10 mg/L, distillation is required to remove the interference.

## Ammonia Low Range (13 mm Vial)

### SPECIFICATIONS

Range	0.00 to 3.00 mg/L (as NH <sub>3</sub> -N)
Resolution	0.01 mg/L
Accuracy	± 0.10 mg/L or ± 5% of reading at 25 °C, whichever is greater
Wavelength	425 nm
Cuvette type	13 mm diameter
Method	Adaptation of the ASTM Manual of Water and Environmental Technology, D1426 Nessler Method
Method ID	#005

### REQUIRED REAGENTS

Code	Description	Quantity
HI93764A-0*	Ammonia Low Range Reagent Vial	1 vial
HI93764-0	Nessler Reagent	4 drops

\*Reagent vial identification: A LR, white label

### REAGENT SETS

HI93764A-25 Reagents for 25 tests

For other accessories see Accessories section.

**Note:** Store the unused vials in their packaging in a cool and dark place.

### MEASUREMENT PROCEDURE

- Select the **Ammonia LR (13 mm)** method using the procedure described in the Factory Methods section.
- Insert the 13 mm vial adapter using the procedure described in the Cuvette & Vial Adapters section.

- Remove the cap from HI93764A-0 Ammonia Low Range Reagent Vial.

- Add 5 mL of sample to the vial, while keeping the vial at a 45-degree angle.

- Replace the cap. Invert several times to mix.

- Insert the vial into the adapter.

- Press **ZERO**. The display will show “-0-” when the meter is zeroed and ready for measurement.

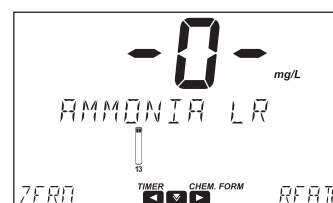
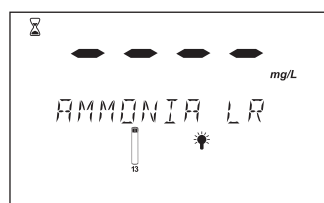
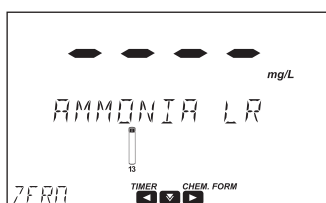
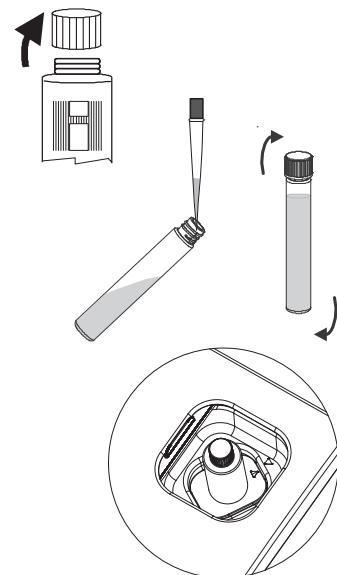

- Remove the vial.
- Remove the cap and add 4 drops of **HI93764-0** Nessler Reagent.
- Replace the cap. Invert the vial several times to mix.

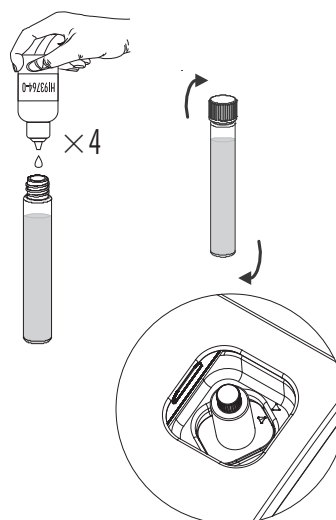

- Insert the vial into the adapter.
- Press the ◀ key to access the timer menu. Press **START** to start Timer 1, the display will show the countdown prior to measurement or wait 3 minutes and 30 seconds.
- Press **READ** to start the reading. The instrument displays the results in **mg/L of ammonia nitrogen (NH<sub>3</sub>-N)**.

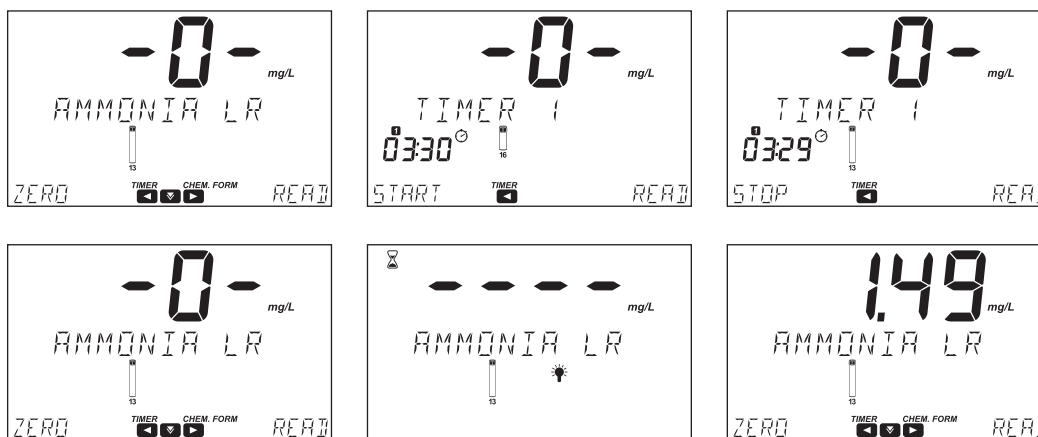

- Press the ▼ key to view the wavelength, method ID, date and time.
- Press the ► key to view the chemical formula.
- Press the ▲ key to convert the results to **mg/L ammonia (NH<sub>3</sub>)** or **ammonium (NH<sub>4</sub><sup>+</sup>)**.

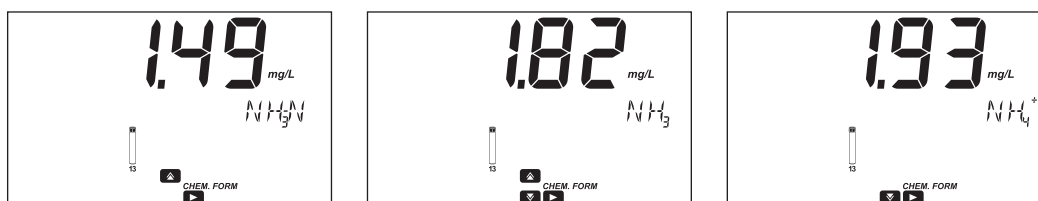

- Press the ► key to return to the measurement screen.

## INTERFERENCE

Interference may be caused by:

- Hardness above 1 g/L
- Iron
- Sulfide may cause turbidity
- Organic compounds like acetone above 0.1%, alcohols, aldehydes, aliphatic and aromatic amines, chloramines, glycine, or urea above 10 mg/L, distillation is required to remove the interference.

## Ammonia Medium Range

### SPECIFICATIONS

Range	0.00 to 10.00 mg/L (as NH <sub>3</sub> -N)
Resolution	0.01 mg/L
Accuracy	± 0.05 mg/L ± 5% of reading at 25 °C, whichever is greater
Wavelength	425 nm
Cuvette type	16 mm diameter
Method	Adaptation of the ASTM Manual of Water and Environmental Technology, D1426, Nessler Method
Method ID	#006

### REQUIRED REAGENTS

Code	Description	Quantity
HI93715A-0	Ammonia Medium Range Reagent A	4 drops
HI93715B-0	Ammonia Medium Range Reagent B	4 drops

### REAGENT SETS

HI93715-01	Reagents for 100 tests
HI93715-03	Reagents for 300 tests

For other accessories see Accessories section.

### MEASUREMENT PROCEDURE

- Select the [Ammonia MR](#) method using the procedure described in the Factory Methods section.

- Fill the cuvette with 10 mL of unreacted sample (up to the mark). Replace the plastic stopper and the cap.

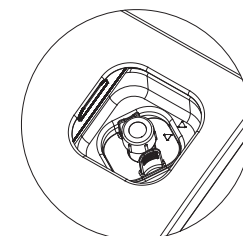
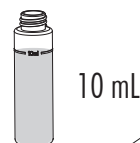

- Insert the 16 mm cuvette adapter using the procedure described in the Cuvette & Vial Adapters section.
- Insert the cuvette into the adapter and close the lid.
- Press **ZERO**. The display will show “-0-” when the meter is zeroed and ready for measurement.

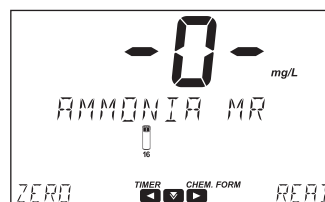
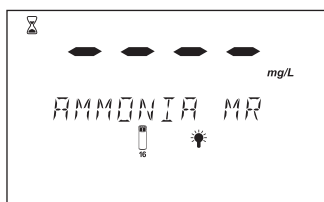
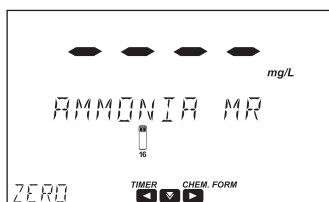

- Remove the cuvette.

- Add 4 drops of [HI93715A-0](#) Ammonia Medium Range Reagent A. Replace the plastic stopper and the cap. Swirl to mix the solution.

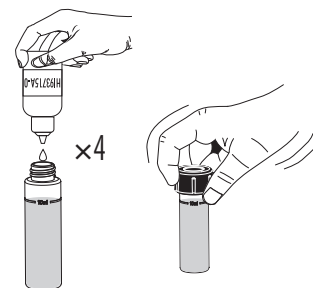



- Add 4 drops of HI93715B-0 Ammonia Medium Range Reagent B. Replace the plastic stopper and the cap. Swirl to mix the solution.

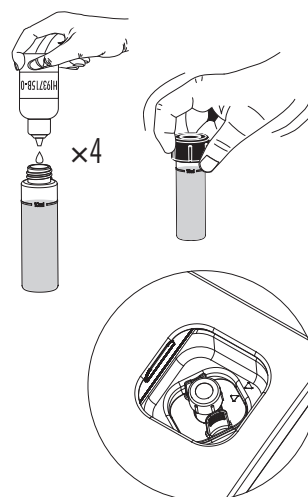

- Insert the cuvette into the adapter and close the lid.
- Press the ◀ key to access the timer menu. Press **START** to start Timer 1, the display will show the countdown prior to measurement or wait 3 minutes and 30 seconds.
- Press **READ** to start the reading. The instrument displays the results in mg/L of ammonia nitrogen ( $\text{NH}_3\text{-N}$ ).

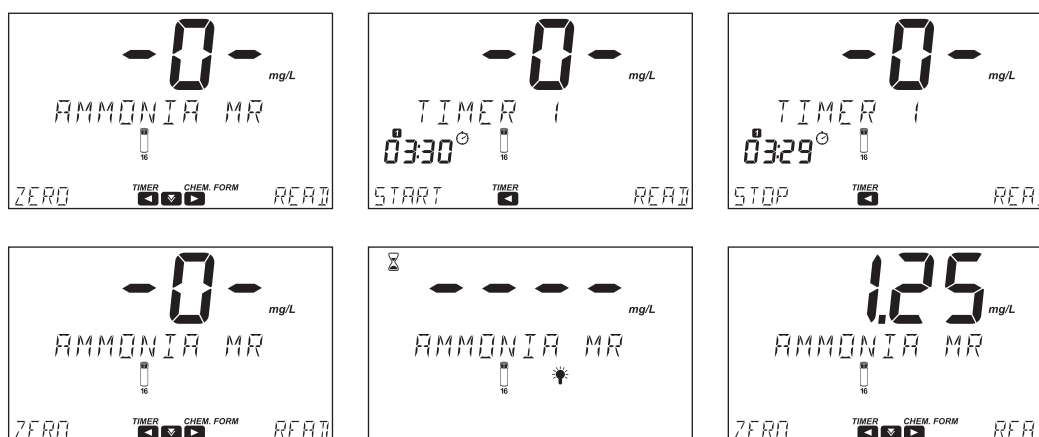

- Press the ▼ key to view the wavelength, method ID, date and time.
- Press the ► key to view the chemical formula.
- Press the ▲ key to convert the results to mg/L of ammonia ( $\text{NH}_3$ ) or ammonium ( $\text{NH}_4^+$ ).

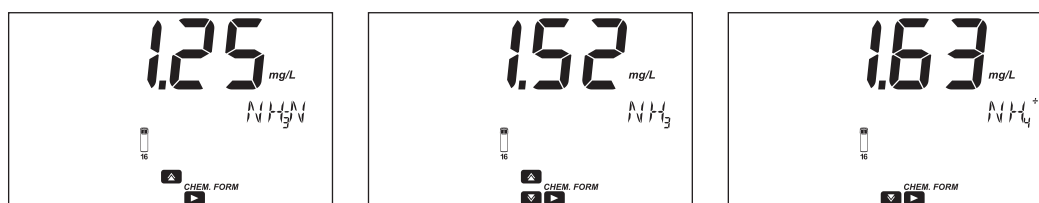

- Press the ► key to return to the measurement screen.

## INTERFERENCES

Interference may be caused by:

- Hardness above 1 g/L
- Iron
- Sulfide may cause turbidity
- Organic compounds like acetone above 0.1%, alcohols, aldehydes, aliphatic and aromatic amines, chloramines, glycine, or urea above 10 mg/L, distillation is required to remove the interference.

## Ammonia High Range

### SPECIFICATIONS

Range	0.0 to 100.0 mg/L (as $\text{NH}_4^+$ )
Resolution	0.1 mg/L
Accuracy	$\pm 0.5$ mg/L $\pm 5\%$ of reading at 25 °C
Wavelength	425 nm
Cuvette type	16 mm diameter
Method	Adaptation of the ASTM Manual of Water and Environmental Technology, D1426, Nessler Method
Method ID	#007

### REQUIRED REAGENTS

Code	Description	Quantity
HI93733A-0	Ammonia High Range Reagent A	4 drops
HI93733B-0	Ammonia High Range Reagent B	9 mL

### REAGENT SETS

HI93733-01	Reagents for 100 tests
HI93733-03	Reagents for 300 tests

For other accessories see Accessories section.

### MEASUREMENT PROCEDURE

- Select the **Ammonia HR** method using the procedure described in the Factory Methods section.
- Insert the 16 mm cuvette adapter using the procedure described in the Cuvette & Vial Adapters section.
- Add 1 mL of unreacted sample to the cuvette using 1 mL syringe.
- Use the pipette to fill the cuvette up to the 10 mL mark with **HI93733B-0** Ammonia High Range Reagent B. Replace the plastic stopper and the cap. Swirl to mix the solution.

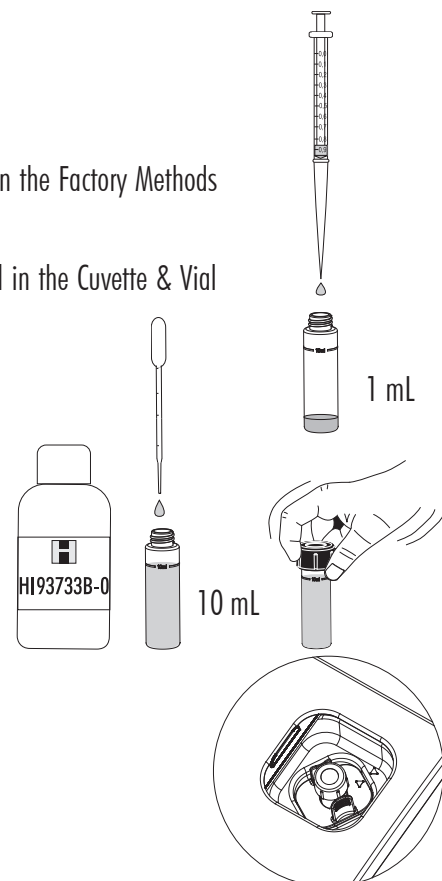

- Insert the cuvette into the holder and close the lid.
- Press **ZERO**. The display will show “-0-” when the meter is zeroed and ready for measurement.

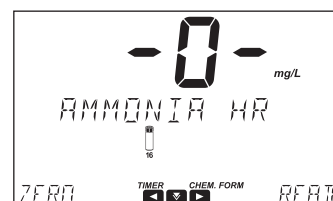
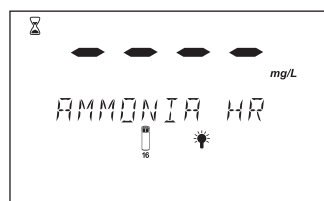
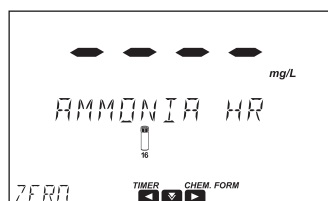

- Remove the cuvette
- Add 4 drops of **HI93733A-0** Ammonia High Range Reagent A. Replace the plastic stopper and the cap. Swirl to mix the solution.

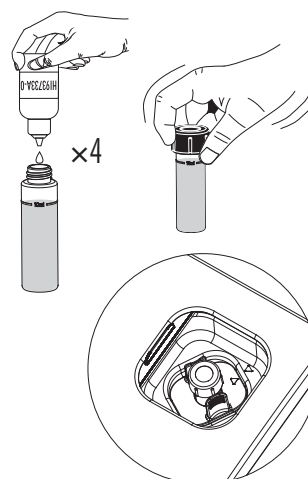

- Insert the cuvette into the adapter and close the lid.
- Press the ◀ key to access the timer menu. Press **START** to start Timer 1, the display will show the countdown or wait 3 minutes and 30 seconds.
- Press **READ** to start the reading. The instrument displays the results in **mg/L of ammonium (NH<sub>4</sub><sup>+</sup>)**.

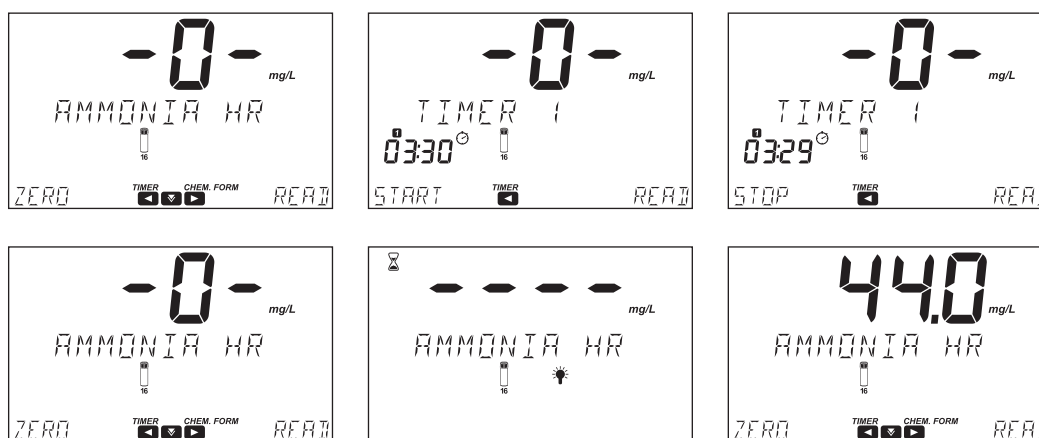

- Press the ▼ key to view the wavelength, method ID, date and time.
- Press the ► key to view the chemical formula.
- Press the ▲ key to convert the results to **mg/L of ammonia nitrogen (NH<sub>3</sub>-N)** or **ammonia (NH<sub>3</sub>)**.

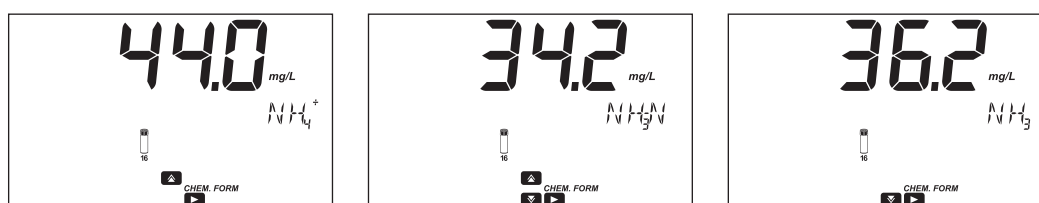

- Press the ► key to return to the measurement screen.

## INTERFERENCES

Interference may be caused by:

- Hardness above 1 g/L
- Iron
- Sulfide may cause turbidity
- Organic compounds like acetone above 0.1%, alcohols, aldehydes, aliphatic and aromatic amines, chloramines, glycine, or urea above 10 mg/L, distillation is required to remove the interference.

## Ammonia High Range (13 mm Vial)

### SPECIFICATIONS

Range	0.0 to 100.0 mg/L (as NH <sub>3</sub> -N)
Resolution	0.1 mg/L
Accuracy	± 1.0 mg/L or ± 5% of reading at 25 °C, whichever is greater
Wavelength	430 nm
Cuvette type	13 mm diameter
Method	Adaptation of the ASTM Manual of Water and Environmental Technology, D1426 Nessler Method
Method ID	#008

### REQUIRED REAGENTS

Code	Description	Quantity
HI93764B-0*	Ammonia Low Range Reagent Vial	1 vial
HI93764-0	Nessler Reagent	4 drops

\*Reagent vial identification: A HR, green label

### REAGENT SETS

HI93764B-25 Reagents for 25 tests

For other accessories see Accessories section.

**Note:** Store the unused vials in their packaging in a cool and dark place.

### MEASUREMENT PROCEDURE

- Select the **Ammonia HR (13 mm)** method using the procedure described in the Factory Methods section.
- Insert the 13 mm vial adapter using the procedure described in the Cuvette & Vial Adapters section.

- Remove the cap from HI93764B-0 Ammonia High Range Reagent Vial.

- Add 1 mL of sample to the vial, while keeping the vial at a 45-degree angle.
- Replace the cap. Invert several times to mix.

- Insert the vial into the adapter.

- Press **ZERO**. The display will show “-0-” when the meter is zeroed and ready for measurement.

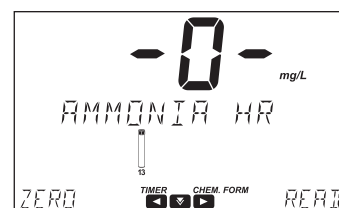
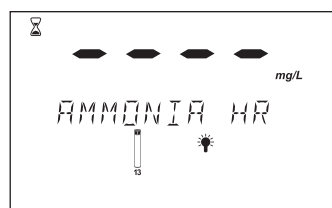
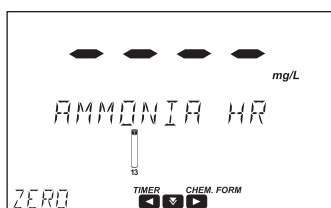
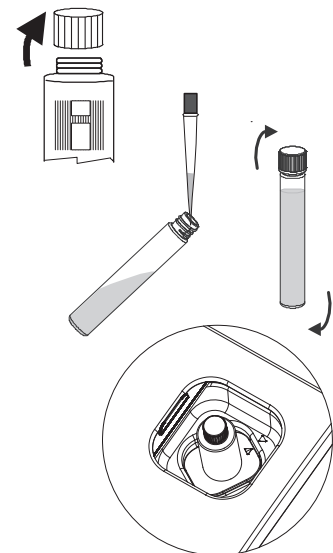

- Remove the vial.
- Remove the cap and add 4 drops of HI93764-0 Nessler Reagent.
- Replace the cap. Invert the vial several times to mix.

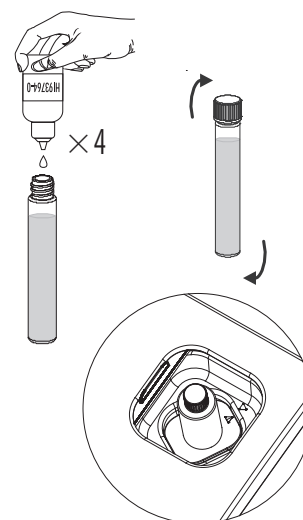

- Insert the vial into the adapter.
- Press the ◀ key to access the timer menu. Press **START** to start Timer 1, the display will show the countdown prior to measurement or wait 3 minutes and 30 seconds.
- Press **READ** to start the reading. The instrument displays the results in mg/L of ammonia nitrogen ( $\text{NH}_3\text{-N}$ ).

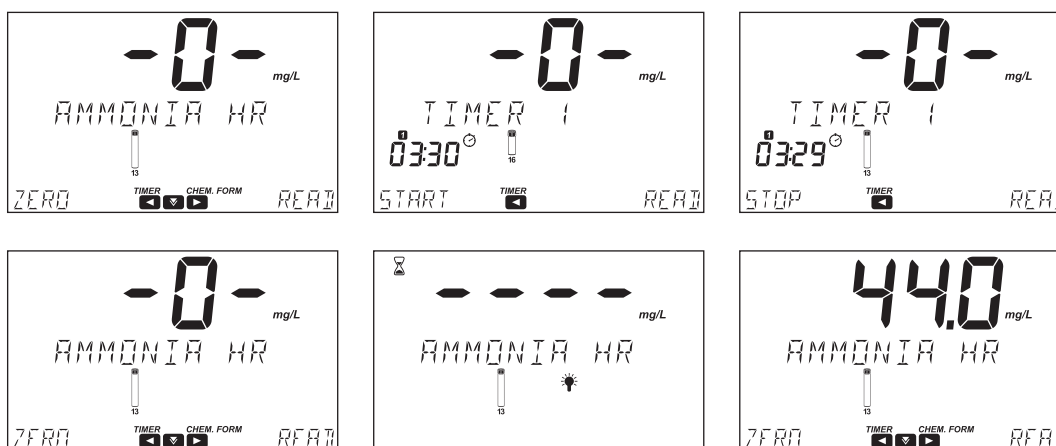

- Press the ▼ key to view the wavelength, method ID, date and time.
- Press the ► key to view the chemical formula.
- Press the ▲ key to convert the results to mg/L ammonia ( $\text{NH}_3$ ) or ammonium ( $\text{NH}_4^+$ ).

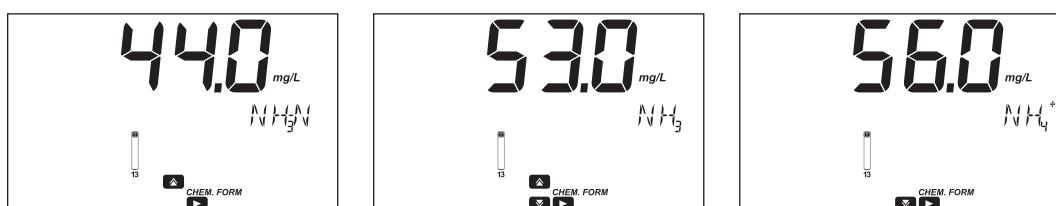

- Press the ► key to return to the measurement screen.

## INTERFERENCE

Interference may be caused by:

- Hardness above 1 g/L
- Iron
- Sulfide may cause turbidity
- Organic compounds like acetone above 0.1%, alcohols, aldehydes, aliphatic and aromatic amines, chloramines, glycine, or urea above 10 mg/L, distillation is required to remove the interference.

## Bromine

### SPECIFICATIONS

Range	0.00 to 10.00 mg/L (as Br <sub>2</sub> )
Resolution	0.01 mg/L
Accuracy	±0.08 mg/L ± 3% of reading at 25 °C
Wavelength	525 nm
Cuvette type	22 mm diameter
Method	Adaptation of the Standard Methods for the Examination of Water and Wastewater, 18 <sup>th</sup> Edition, DPD Method
Method ID	#009

### REQUIRED REAGENTS

Code	Description	Quantity
HI93716-0	Bromine Reagent	1 packet

### REAGENT SETS

HI93716-01 Reagents for 100 tests

HI93716-03 Reagents for 300 tests

For other accessories see Accessories section.

### MEASUREMENT PROCEDURE

- Select the **Bromine** method using the procedure described in the Factory Methods section.

- Fill the cuvette with 10 mL of unreacted sample (up to the mark). Replace the plastic stopper and the cap.

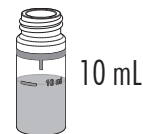

- Insert the cuvette into the holder and close the lid.

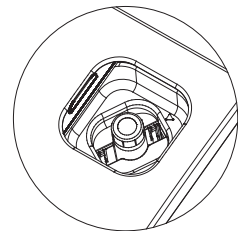

- Press **ZERO**. The display will show “-0-” when the meter is zeroed and ready for measurement.

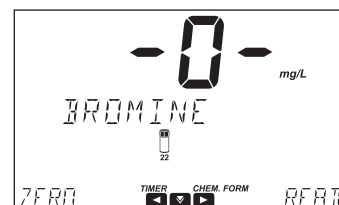
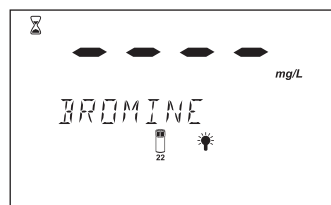
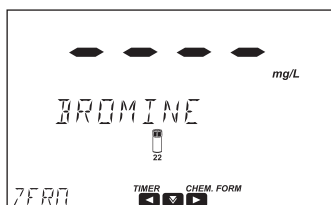

- Remove the cuvette
- Add one packet of **HI93716-0** Bromine Reagent. Replace the plastic stopper and the cap. Shake gently for about 20 seconds to dissolve most of the reagent.

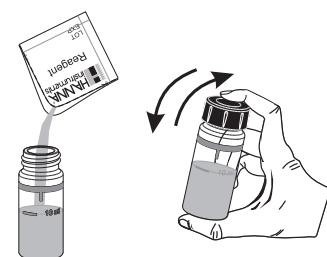

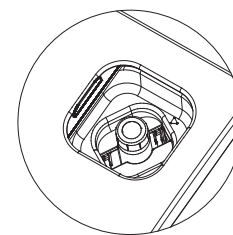

- Insert the cuvette into the holder and close the lid.
- Press the ◀ key to access the timer menu. Press **START** to start Timer 1, the display will show the countdown prior to measurement or wait 2 minutes and 30 seconds.
- Press **READ** to start the reading. The instrument displays the results in mg/L of bromine (Br<sub>2</sub>).

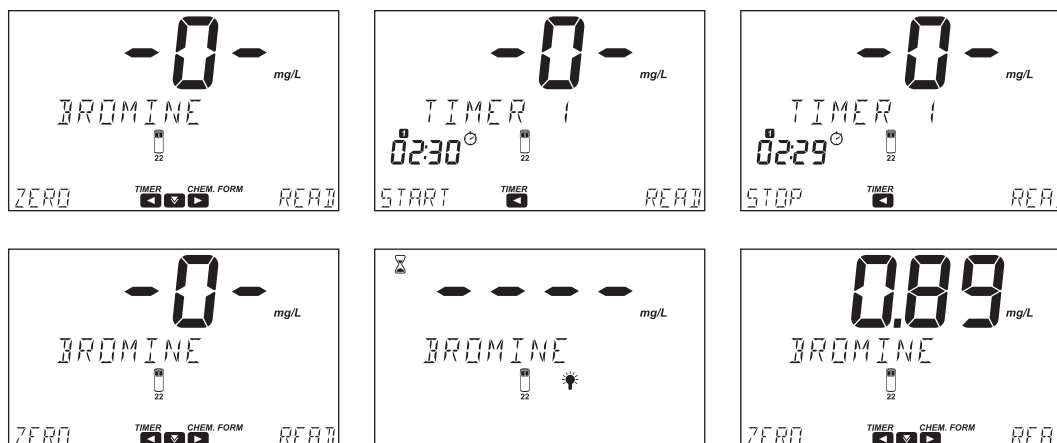

- Press the ▼ key to view the wavelength, method ID, date and time.
- Press the ▶ key to view the chemical formula.

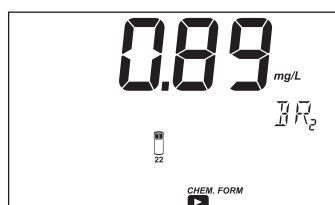

- Press the ▶ key to return to the measurement screen.

## INTERFERENCES

Interference may be caused by:

- Chlorine, Iodine, Ozone, Oxidized forms of Chromium and Manganese
- Hardness greater than 500 mg/L CaCO<sub>3</sub>, to remove the interference shake the sample for approximately 1 minute after adding the reagent
- Alkalinity greater than 300 mg/L CaCO<sub>3</sub> or acidity greater than 150 mg/L CaCO<sub>3</sub>, the color of the sample may develop only partially or rapidly fade, to remove the interference neutralize the sample with diluted HCl or NaOH

## Calcium

### SPECIFICATIONS

Range	0 to 400 mg/L (as Ca <sup>2+</sup> )
Resolution	1 mg/L
Accuracy	±10 mg/L ±5% of reading at 25 °C
Wavelength	466 nm
Cuvette type	22 mm diameter
Method	Adaptation of the Oxalate Method
Method ID	#010

### REQUIRED REAGENTS

Code	Description	Quantity
-	Buffer Reagent	4 drops
HI93752A-Ca	Calcium Reagent A	7 mL
HI93752B-Ca	Calcium Reagent B	1 mL

### REAGENT SETS

HI937521-01	Reagents for 50 tests
HI937521-03	Reagents for 150 tests

For other accessories see Accessories section.

### MEASUREMENT PROCEDURE

- Select the **Calcium** method using the procedure described in the Factory Methods section.

- Add 3 mL of unreacted sample to the cuvette using the 5 mL syringe.

- Use the pipette to fill the cuvette up to the 10 mL mark with the **HI93752A-Ca** Calcium Reagent A.

- Add 4 drops of Buffer Reagent.

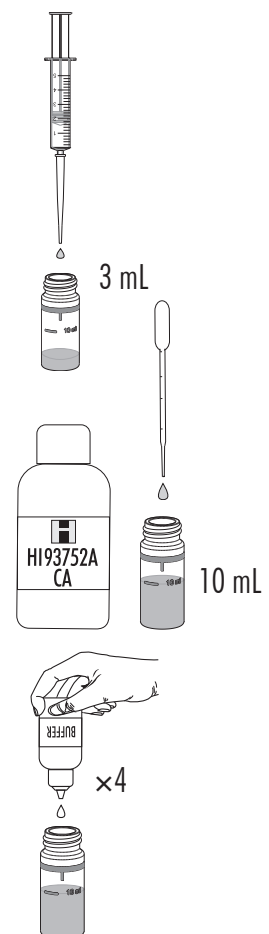



- Replace the plastic stopper and the cap. Invert several times to mix.



- Insert the cuvette into the holder and close the lid.

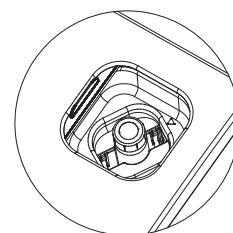

- Press **ZERO**. The display will show “-0-” when the meter is zeroed and ready for measurement.

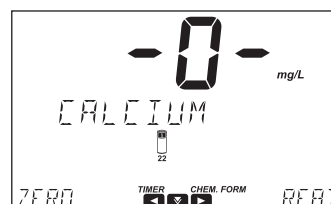
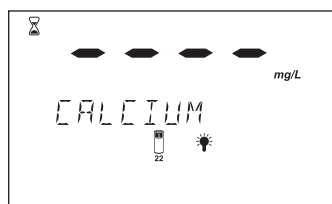
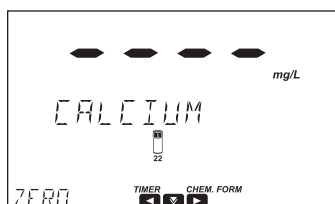

- Remove the cuvette.

- Add 1 mL of **HI93752B-Ca** Calcium Reagent B to the sample using the 1 mL syringe. Replace the plastic stopper and the cap. Invert the cuvette 10 times to mix (about 15 seconds).

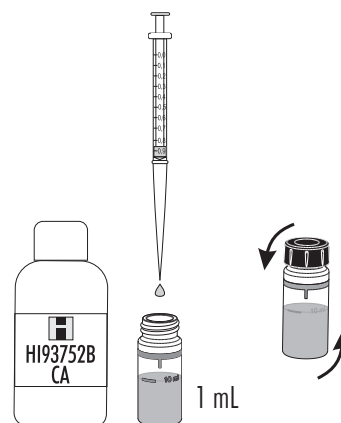

- Insert the cuvette into the holder and close the lid.

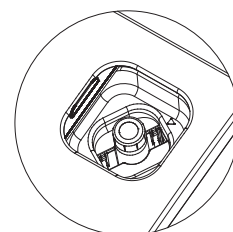

- Press the **◀** key to access the timer menu. Press **START** to start Timer 1, the display will show the countdown or wait 5 minutes.

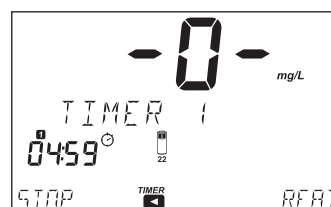
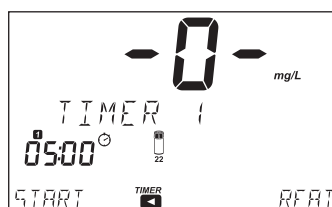
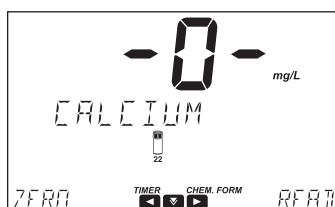

- Invert the cuvette 10 times to mix (about 15 seconds).



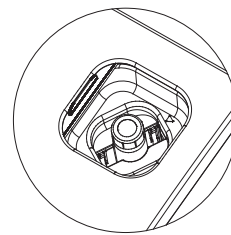

- Insert the cuvette into the holder and close the lid.

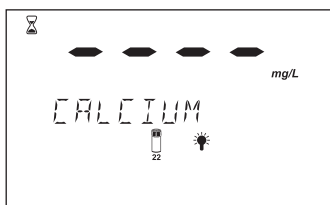
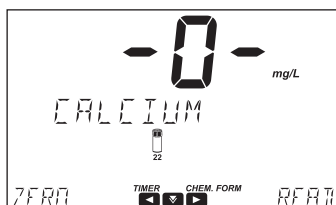

- Press **READ** to start the reading. The instrument displays the results in mg/L of calcium ( $\text{Ca}^{2+}$ ).



- Press the  key to view the wavelength, method ID, date and time.
- Press the  key to view the chemical formula.

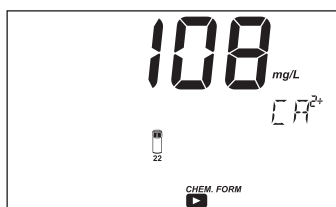

- Press the  key to return to the measurement screen.

## INTERFERENCES

Interferences may be caused by:

- Acidity, Alkalinity above 1000 mg/L  $\text{CaCO}_3$
- Magnesium above 400 mg/L

## Calcium, Marine

### SPECIFICATIONS

Range	200 to 600 mg/L (as Ca <sup>2+</sup> )
Resolution	1 mg/L
Accuracy	± 5% of reading at 25 °C
Wavelength	610 nm
Cuvette type	16 mm diameter
Method	Adaptation of the Zincon Method
Method ID	#011

### REQUIRED REAGENTS

Code	Description	Quantity
HI7581	Calcium Reagent A	1 mL
HI7582	Calcium Reagent B	1 packet

### REAGENT SETS

HI758-26 Reagents for 25 tests  
For other accessories see Accessories section.

### MEASUREMENT PROCEDURE

- Select the **Calcium Marine** method using the procedure described in the Factory Methods section.
- Insert the 16 mm cuvette adapter using the procedure described in the Cuvette & Vial Adapters section.

- Add 1 mL of **HI7581** Calcium Reagent A to the cuvette using a 1 mL syringe.
- Use the plastic pipette to fill the cuvette to the 10 mL mark with deionized water and replace the plastic stopper and the cap. Invert 5 times to mix.

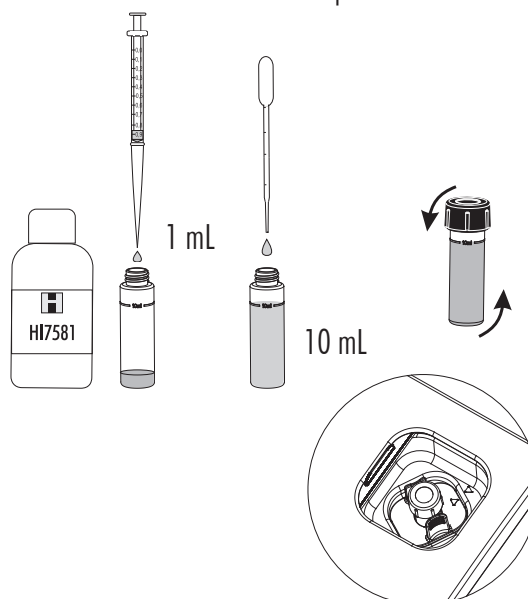

- Insert the cuvette into the adapter and close the lid.
- Press **ZERO**. The display will show “-0-” when the meter is zeroed and ready for measurement.

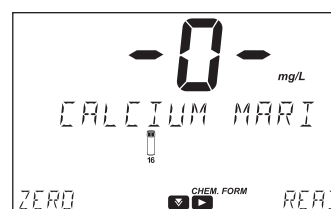
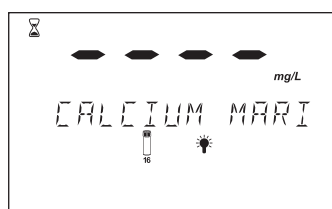
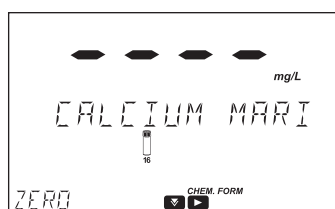

- Remove the cuvette.

- Use the [HI731339](#) micropipette to add 0.1 mL of sample to the cuvette.

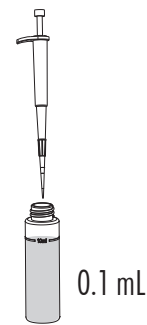

- Add one packet of [HI7582](#) Calcium Reagent B. Replace the plastic stopper and the cap. Shake vigorously for 15 seconds or until the powder is completely dissolved. Allow air bubbles to dissipate for 15 seconds before taking a reading.

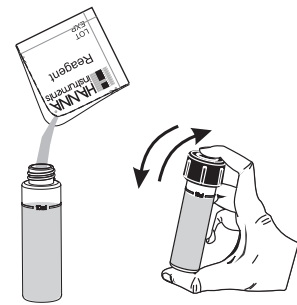

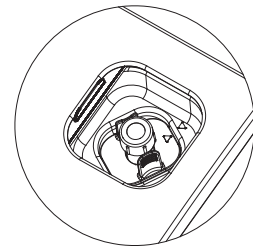

- Insert the cuvette into the adapter and close the lid.

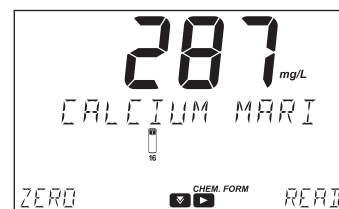
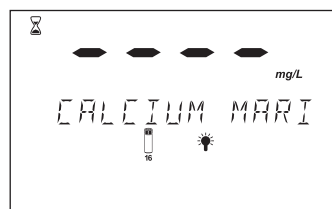
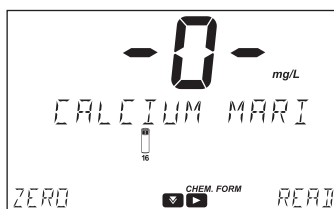

- Press **READ** to start the reading. The instrument displays the results in mg/L of calcium ( $\text{Ca}^{2+}$ ).



- Press the  key to view the wavelength, method ID, date and time.
- Press the  key to view the chemical formula.

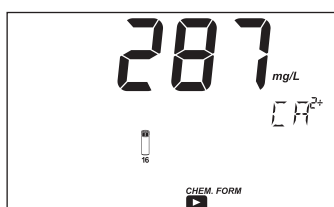

- Press the  key to return to the measurement screen.

## Chloride

### SPECIFICATIONS

Range	0.0 to 20.0 mg/L (as Cl <sup>-</sup> )
Resolution	0.1 mg/L
Accuracy	±0.5 mg/L ±5% of reading at 25 °C
Wavelength	455 nm
Cuvette type	22 mm diameter
Method	Adaptation of the Mercury (II) Thiocyanate Method
Method ID	#012

### REQUIRED REAGENTS

Code	Description	Quantity
HI93753A-0	Chloride Reagent A	1 mL
HI93753B-0	Chloride Reagent B	1 mL

### REAGENT SETS

HI93753-01	Reagents for 100 tests
HI93753-03	Reagents for 300 tests

For other accessories see Accessories section.

### MEASUREMENT PROCEDURE

- Select the **Chloride** method using the procedure described in the Factory Methods section.

- Fill one cuvette (#1) with 10 mL of deionized water (up to the mark).



- Fill another cuvette (#2) with 10 mL of sample (up to the mark).



**Note:** For samples with low chloride ion concentration, rinse the cuvette a few times with sample before filling it with 10 mL of sample. For the most accurate results, use two graduated pipettes to deliver exactly 10 mL of deionized water and 10 mL of sample to the cuvettes.

- Add 0.5 mL of HI93753A-0 Chloride Reagent A to each cuvette using the 1 mL syringe.

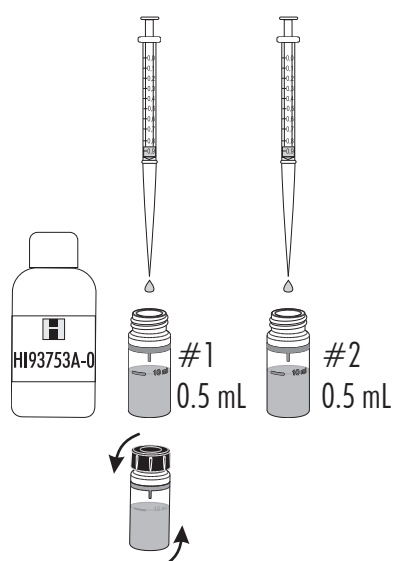

- Replace the plastic stoppers and the caps. Mix each cuvette by inverting for approximately 30 seconds.

- Add 0.5 mL of HI93753B-0 Chloride Reagent B to each cuvette using the second 1 mL syringe.

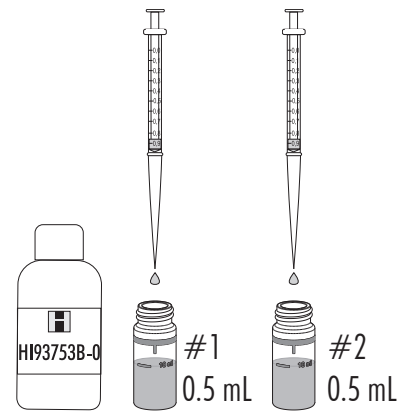

- Replace the plastic stoppers and the caps. Mix each cuvette by inverting for approximately 30 seconds.



- Insert the cuvette with the reacted deionized water (#1) into the holder and close the lid.

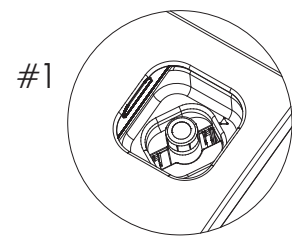

- Press the ◀ key to access the timer menu. Press **START** to start Timer 1, the display will show the countdown prior to the zero or wait 2 minutes.
- Press **ZERO**. The display will show “-0-” when the meter is zeroed and ready for measurement.

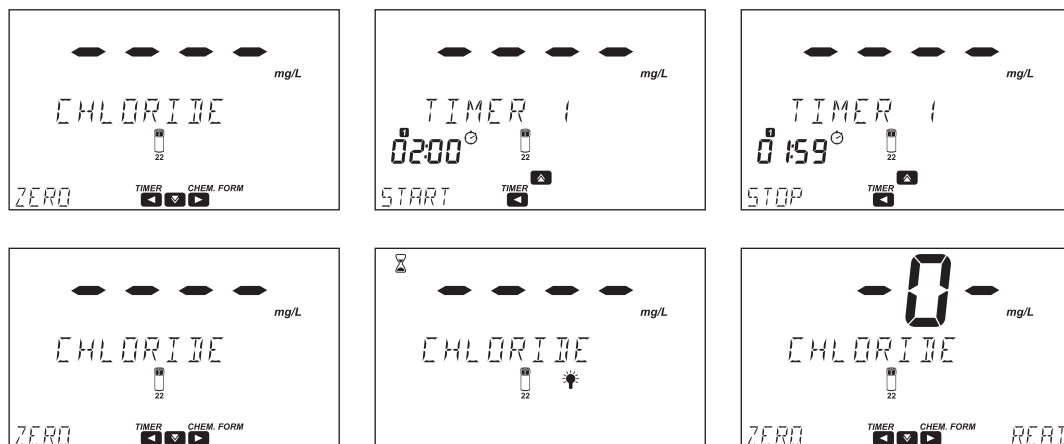

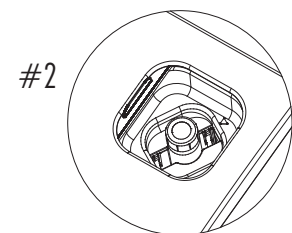

- Remove the cuvette.
- Insert the other cuvette (#2) with the reacted sample into the holder and close the lid.

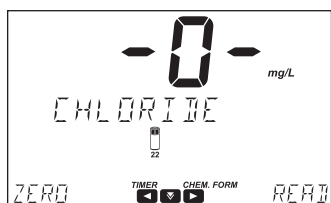

- Press **READ** to start reading. The instrument displays the results in mg/L of chloride (Cl<sup>-</sup>).



- Press the  key to view the wavelength, method ID, date and time.
- Press the  key to view the chemical formula.

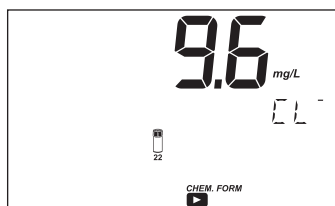

- Press the  key to return to the measurement screen.

## INTERFERENCES

Interference may be caused by:

- Intensely colored samples, samples should be adequately treated before performing the test
- Suspended matter in large amount should be removed by prior filtration
- Alkaline samples, neutralize before adding reagents, the pH of the sample after addition of reagents should be about 2

## Chlorine Dioxide

### SPECIFICATIONS

Range	0.00 to 2.00 mg/L (as ClO <sub>2</sub> )
Resolution	0.01 mg/L
Accuracy	±0.10 mg/L ± 5% of reading at 25 °C
Wavelength	575 nm
Cuvette type	22 mm diameter
Method	Adaptation of the Chlorophenol Red Method
Method ID	#013

### REQUIRED REAGENTS

Code	Description	Quantity
HI93738A-0	Chlorine Dioxide Reagent A	1 mL
HI93738B-0	Chlorine Dioxide Reagent B	1 packet
HI93738C-0	Chlorine Dioxide Reagent C	1 mL
HI93738D-0	Chlorine Dioxide Reagent D	1 mL

### REAGENT SETS

HI93738-01	Reagents for 100 tests
HI93738-03	Reagents for 300 tests

For other accessories see Accessories section.

### SAMPLING PROCEDURE

It is recommended to analyze chlorine dioxide samples immediately after collection. Chlorine Dioxide samples must be stored in sealed dark glass bottle, with minimal head space. Excessive heat (above 25 °C /77 °F), agitation and exposure to light must be avoided.

### MEASUREMENT PROCEDURE

- Select the **Chloride Dioxide** method using the procedure described in the Factory Methods section.

- Fill two graduated mixing cylinders (#1 & #2) up to the 25 mL mark with the sample.

- Add 0.5 mL of **HI93738A-0** Chlorine Dioxide Reagent A to each graduated mixing cylinder (#1 & #2), using a 1 mL syringe, replace the caps. Invert several times to mix.

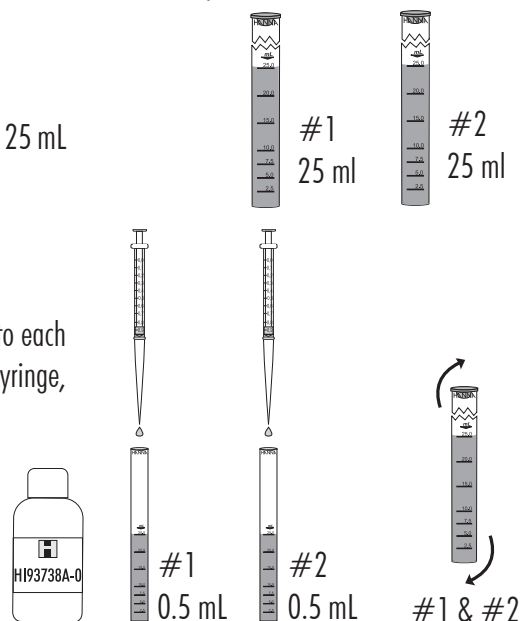



- Add one packet of **HI93738B-0** Chlorine Dioxide Reagent B to one of the two graduated mixing cylinder (#1), replace the cap. Invert several times until the reagent is totally dissolved. This is the blank.

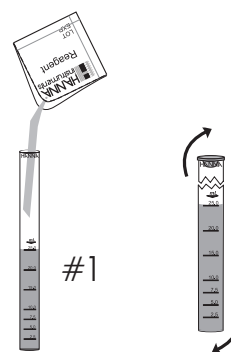

- Add 0.5 mL of **HI93738C-0** Chlorine Dioxide Reagent C to each graduated mixing cylinder (#1 & #2), using a 1 mL syringe, replace the cap. Invert several times to mix.

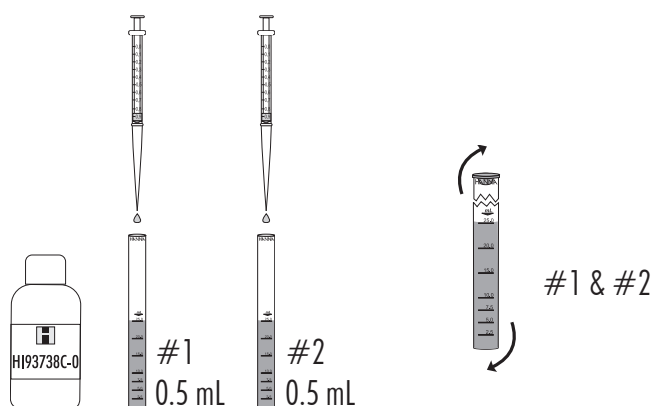

- Add 0.5 mL of **HI93738D-0** Chlorine Dioxide Reagent to each graduated mixing cylinder (#1 & #2), using a 1 mL syringe, replace the cap. Invert several times to mix. Graduated glass cylinder #2 is the reacted sample.

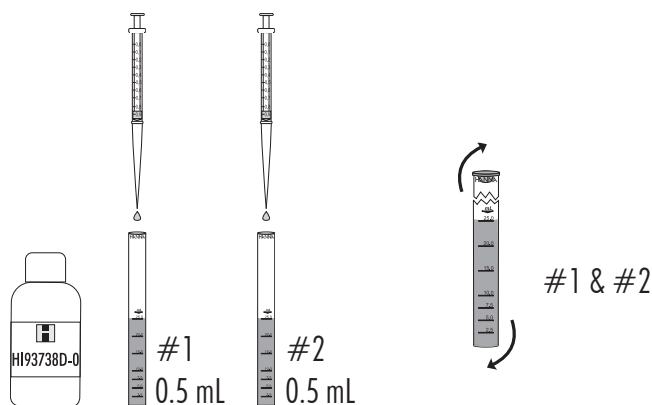

- Fill cuvette (#1) with 10 mL of the blank (up to the mark). Replace the plastic stopper and the cap.

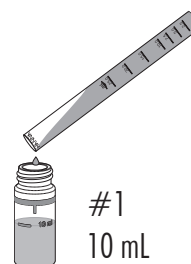

- Insert the blank (#1) into the holder and close the lid.

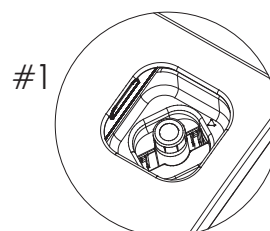

- Press **ZERO**. The display will show “-0-” when the meter is zeroed and ready for measurement.



- Fill second cuvette (#2) with 10 mL of the reacted sample (up to the mark). Replace the plastic stopper and the cap.

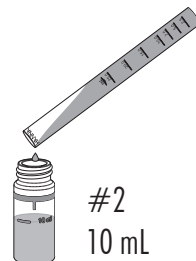

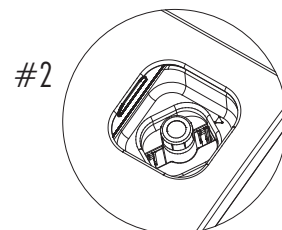

- Insert the sample (#2) into the holder and close the lid.



- Press **READ** to start the reading. The instrument displays the results in mg/L of chlorine dioxide ( $\text{ClO}_2$ ).



- Press the  key to view the wavelength, method ID, date and time.
- Press the  key to view the chemical formula.

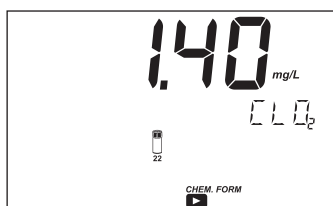

- Press the key to return to the measurement screen.

### INTERFERENCES

Interferences may be caused by:

- Strong oxidants

## Chlorine Dioxide (Rapid)

### SPECIFICATIONS

Range	0.00 to 2.00 mg/L (as ClO <sub>2</sub> )
Resolution	0.01 mg/L
Accuracy	±0.10 mg/L ±5% of reading at 25 °C
Wavelength	525 nm
Cuvette type	22 mm diameter
Method	Adaptation of Standard Methods for the Examination of Water and Wastewater, 18 <sup>th</sup> Edition, 4500 ClO <sub>2</sub> D
Method ID	#086

### REQUIRED REAGENT

Code	Description	Quantity
HI96779A-0	Chlorine Dioxide Reagent A	5 drops
HI96779B-0	Chlorine Dioxide Reagent B	1 packet

### REAGENT SETS

HI96779-01	Reagents for 100 tests
HI96779-03	Reagents for 300 tests

For other accessories see Accessories section.

### PRINCIPLE

The reaction between the Chlorine Dioxide and DPD indicator causes a pink tint in the sample, the addition of glycine as a masking agent inhibits the response of free chlorine.

### APPLICATION

Drinking water, tap water, treated water

### SAMPLING PROCEDURE

Collect the sample in a clean glass bottle and analyze it immediately. Chlorine dioxide is a strong oxidizing agent and is unstable in water.

### SIGNIFICANCE & USE

Chlorine Dioxide is a commonly-used alternative to chlorine (Cl<sub>2</sub>) as a water disinfectant. The Chlorophenol Red method (non-rapid method) reacts specifically with chlorine dioxide with little interference from free chlorine or chloramines, but the method procedure is cumbersome. The Chlorine Dioxide Rapid Method based on the DPD (N,N-diethyl-p-phenylenediamine) indicator is a much simpler method by comparison, but it is susceptible to interference from other oxidizers. Glycine (Reagent A) is able to convert free chlorine to chloroaminoacetic acid without affecting the analysis of chlorine dioxide content.

### MEASUREMENT PROCEDURE

- Select the [Chlorine Dioxide \(Rapid\)](#) method using the procedure described in the Factory Methods section.
- Fill a cuvette with 10 mL of unreacted sample (up to the mark).



10 mL

- Add 5 drops of **HI96779A-0** Chlorine Dioxide Reagent A.



- Replace the plastic stopper and the cap. Shake gently for 30 seconds.



- Wait 30 seconds.



- Insert the cuvette into the holder and close the lid.

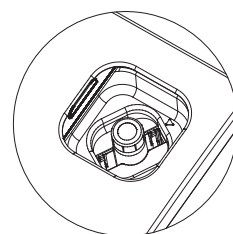

- Press **ZERO**. The display will show “-0-” when the meter is zeroed and ready for measurement.

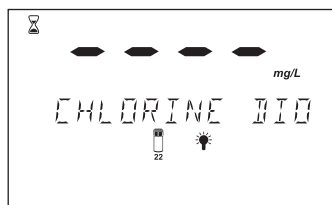
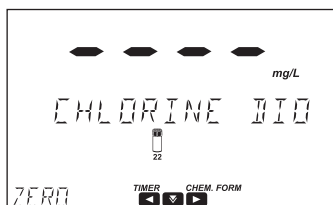

- Remove the cuvette.
- Add one packet of **HI96779B-0** Chlorine Dioxide Reagent B to the cuvette. Replace the plastic stopper and the cap. Shake gently for 20 seconds.

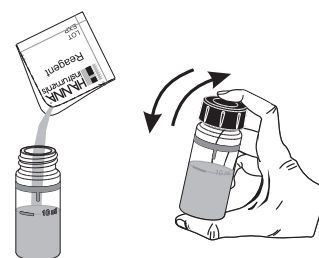

- Insert the cuvette into the holder and close the lid.

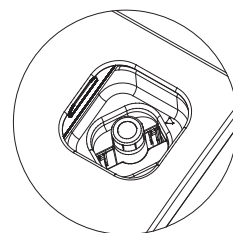

- Press the ◀ key to access the timer menu. Press **START** to start Timer 1, the display will show the countdown prior to measurement or wait 1 minute.
- Press **READ** to start the reading. The instrument displays the results in mg/L of ClO<sub>2</sub>.

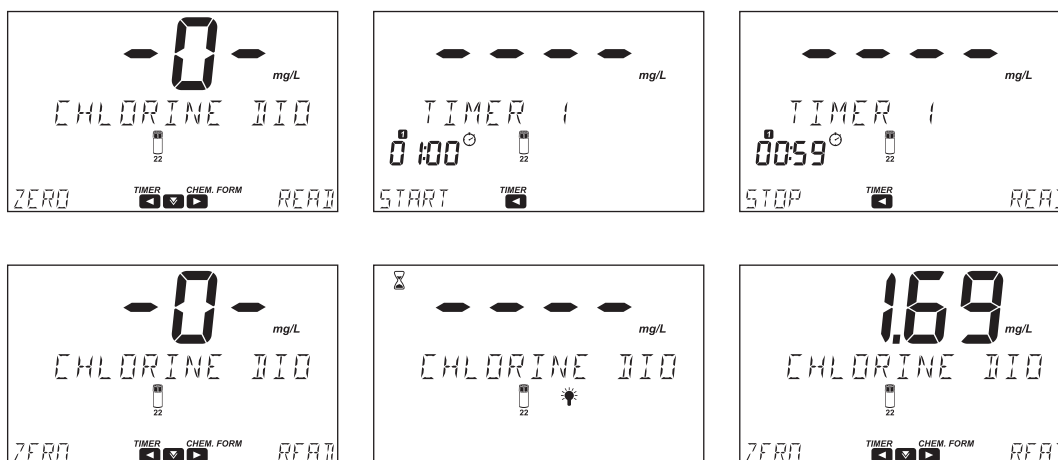

- Press the ▼ key to view the wavelength, method ID, date and time.
- Press the ▶ key to view the chemical formula.

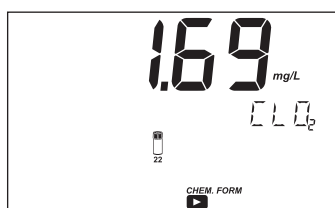

- Press the ▶ key to return to the measurement screen.

## INTERFERENCES

Interference may be caused by:

- Acidity, Alkalinity, Flocculating agents, Hardness, Inorganic and Organic Chloramines, Manganese, Metals, Monochloramine, Oxidized forms of Chromium and Manganese, Ozone and Peroxides
- Chlorine above 5 mg/L
- Bromine above 0.1 mg/L
- Highly buffered samples or extreme sample pH

## Chlorine, Free Ultra Low Range

### SPECIFICATIONS

Range	0.000 to 0.500 mg/L (as Cl <sub>2</sub> )
Resolution	0.001 mg/L
Accuracy	±0.020 mg/L ±3% of reading at 25 °C
Wavelength	525 nm
Cuvette type	22 mm diameter
Method	Adaptation of the EPA DPD Method 330.5
Method ID	#014

### REQUIRED REAGENTS

Code	Description	Quantity
HI95762-0	Free Chlorine Ultra Low Range Reagent	1 packet

### REAGENT SETS

HI95762-01 Reagents for 100 tests

HI95762-03 Reagents for 300 tests

For other accessories see Accessories section.

### MEASUREMENT PROCEDURE

- Select the **Chlorine Free ULR** method using the procedure described in the Factory Methods section.

- Fill the cuvette with 10 mL of unreacted sample (up to the mark). Replace the plastic stopper and the cap.



- Insert the cuvette into the holder and close the lid.

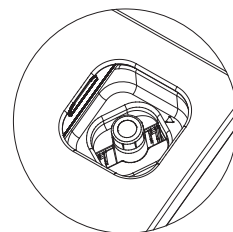

- Press **ZERO**. The display will show “-0-” when the meter is zeroed and ready for measurement.



- Remove the cuvette.

- Add one packet of **HI95762-0** Free Chlorine ULR Reagent. Replace the plastic stopper and the cap. Shake gently for 20 seconds.

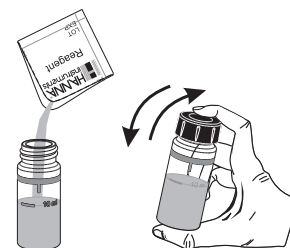

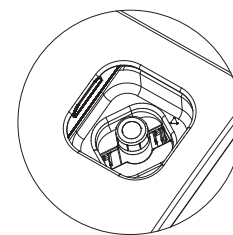

- Insert the cuvette into the holder and close the lid.
- Press the ◀ key to access the timer menu. Press **START** to start Timer 1, the display will show the countdown prior to measurement or wait 1 minute.
- Press **READ** to start the reading. The instrument displays the results in mg/L of chlorine ( $\text{Cl}_2$ ).

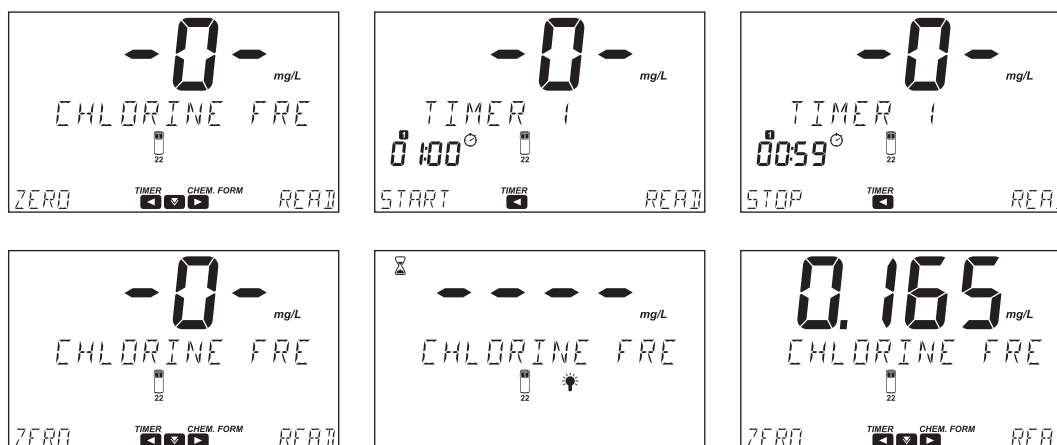

- Press the ▼ key to view the wavelength, method ID, date and time.
- Press the ▶ key to view the chemical formula.

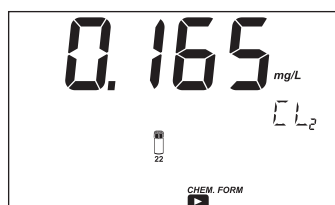

- Press the ▶ key to return to the measurement screen.

## INTERFERENCES

Interference may be caused by:

- Bromine, Chlorine Dioxide, Iodine, Oxidized forms of Chromium and Manganese, Ozone
- Alkalinity greater than 1000 mg/L  $\text{CaCO}_3$  if present as bicarbonate ( $\text{pH} < 8.3$ ), above 25 mg/L  $\text{CaCO}_3$  if present as carbonate ( $\text{pH} > 9.0$ ) or acidity value greater than 150 mg/L  $\text{CaCO}_3$ , the color of the sample may develop only partially or rapidly fade, to remove the interference neutralize the sample with diluted HCl or NaOH
- Hardness greater than 500 mg/L  $\text{CaCO}_3$ , to remove the interference shake the sample for approximately 2 minutes after adding the powder reagent

## Chlorine, Free Low Range (Powder Reagent)

### SPECIFICATIONS

Range	0.00 to 5.00 mg/L (as Cl <sub>2</sub> )
Resolution	0.01 mg/L
Accuracy	±0.03 mg/L ± 3% of reading at 25 °C
Wavelength	525 nm
Cuvette type	22 mm diameter
Method	Adaptation of the EPA DPD Method 330.5
Method ID	#015

### REQUIRED REAGENTS

Code	Description	Quantity
HI93701-0	Free Chlorine Reagent	1 packet

### REAGENT SETS

HI93701-01 Reagents for 100 tests

HI93701-03 Reagents for 300 tests

For other accessories see Accessories section.

### MEASUREMENT PROCEDURE

- Select the **Chlorine Free LR (POWDER)** method using the procedure described in the Factory Methods section.

- Fill the cuvette with 10 mL of unreacted sample (up to the mark). Replace the plastic stopper and the cap.

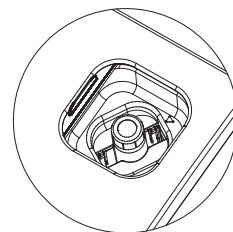

- Insert the cuvette into the holder and close the lid.

- Press **ZERO**. The display will show “-0-” when the meter is zeroed and ready for measurement.

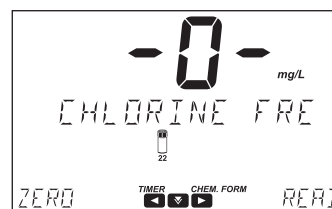
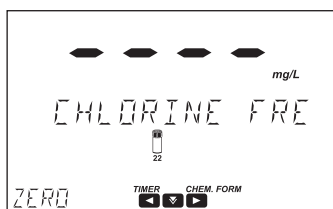

- Remove the cuvette.

- Add one packet of **HI93701-0** Free Chlorine Reagent. Replace the plastic stopper and the cap. Shake gently for 20 seconds.

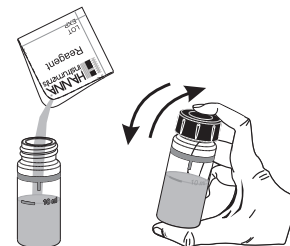



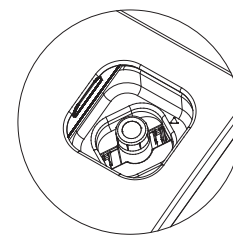

- Insert the cuvette into the holder and close the lid.
- Press the ◀ key to access the timer menu. Press **START** to start Timer 1, the display will show the countdown prior to measurement or wait 1 minute.
- Press **READ** to start the reading. The instrument displays the results in mg/L of chlorine ( $\text{Cl}_2$ ).

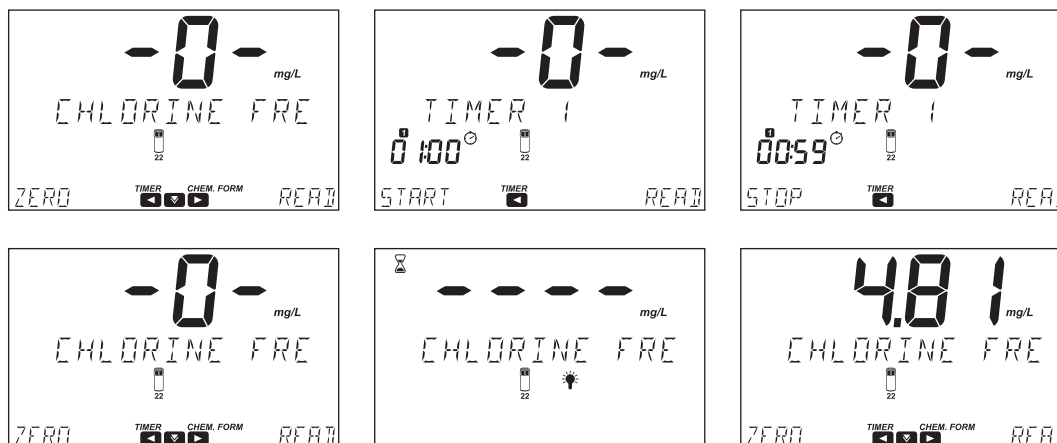

- Press the ▼ key to view the wavelength, method ID, date and time.
- Press the ► key to view the chemical formula.

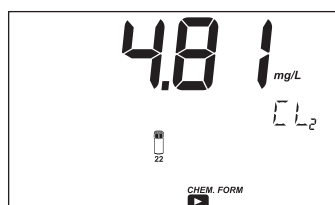

- Press the ► key to return to the measurement screen.

**Note:** Free and Total Chlorine have to be measured separately with fresh sample following the related procedure if both values are desired.

## INTERFERENCES

Interference may be caused by:

- Bromine, Iodine, Oxidized forms of Chromium and Manganese, Ozone
- Hardness greater than 500 mg/L  $\text{CaCO}_3$ , to remove the interference shake the sample for approximately 2 minutes after adding the powder reagent
- Alkalinity greater than 250 mg/L  $\text{CaCO}_3$  or acidity value greater than 150 mg/L  $\text{CaCO}_3$ , the color of the sample may develop only partially or rapidly fade, to remove the interference neutralize the sample with diluted HCl or NaOH

## Chlorine, Free Low Range (Liquid Reagent)

### SPECIFICATIONS

Range	0.00 to 5.00 mg/L (as Cl <sub>2</sub> )
Resolution	0.01 mg/L
Accuracy	±0.03 mg/L ± 3% of reading at 25 °C
Wavelength	525 nm
Cuvette type	22 mm diameter
Method	Adaptation of the EPA DPD Method 330.5
Method ID	#016

### REQUIRED REAGENTS

Code	Description	Quantity
HI93701A-F	Free Chlorine Reagent A	3 drops
HI93701B-F	Free Chlorine Reagent B	3 drops

### REAGENT SETS

HI93701-F Reagents for 300 tests (liquid)

For other accessories see Accessories section.

### MEASUREMENT PROCEDURE

- Select the **Chlorine Free LR (LIQUID)** method using the procedure described in the Factory Methods section.

- Fill the cuvette with 10 mL of unreacted sample (up to the mark). Replace the plastic stopper and the cap.

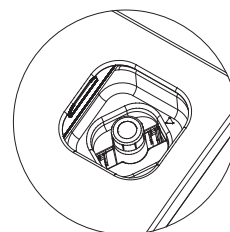

- Insert the cuvette into the holder and close the lid.
- Press **ZERO**. The display will show “-0-” when the meter is zeroed and ready for measurement.



- Remove the cuvette.
- To an empty cuvette add 3 drops of HI93701A-F Free Chlorine Reagent A and 3 drops of HI93701B-F Free Chlorine Reagent B. Replace the plastic stopper and the cap. Swirl gently to mix.

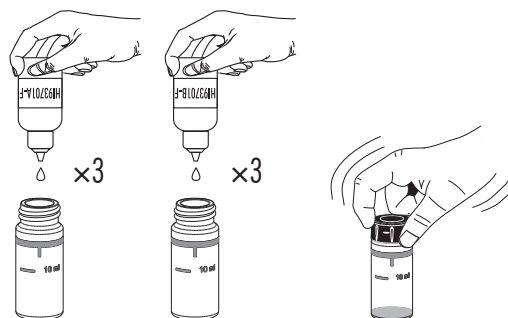

- Add 10 mL of unreacted sample (up to the mark). Replace the plastic stopper and the cap. Shake gently to mix.

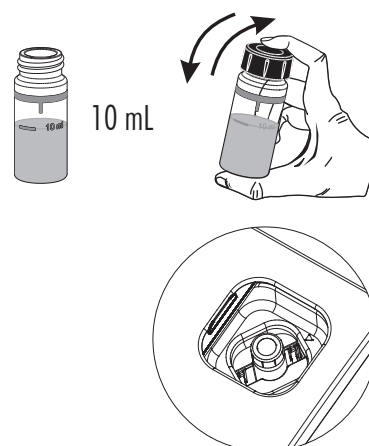

- Insert the cuvette into the holder and close the lid.
- Press the ◀ key to access the timer menu. Press **START** to start Timer 1, the display will show the countdown prior to measurement or wait 1 minute.
- Press **READ** to start the reading. The instrument displays the results in mg/L of chlorine ( $\text{Cl}_2$ ).

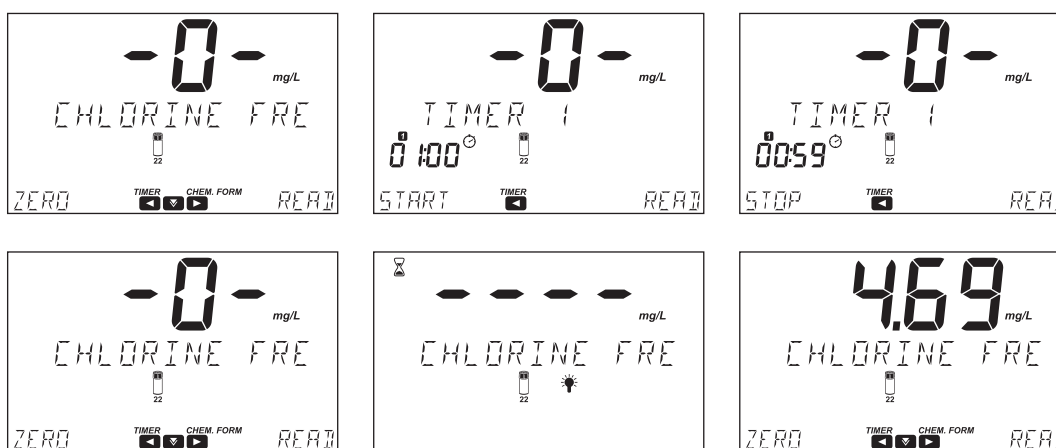

- Press the ✓ key to view the wavelength, method ID, date and time.
- Press the ▶ key to view the chemical formula.

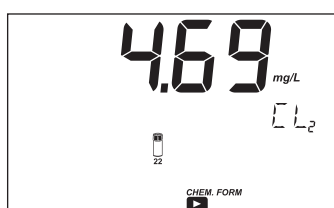

- Press the ▶ key to return to the measurement screen.

## INTERFERENCES

Interference may be caused by:

- Bromine, Iodine, Oxidized forms of Chromium and Manganese, Ozone
- Hardness greater than 500 mg/L  $\text{CaCO}_3$ , to remove the interference shake the sample for approximately 2 minutes after adding the powder reagent
- Alkalinity greater than 250 mg/L  $\text{CaCO}_3$  or acidity value greater than 150 mg/L  $\text{CaCO}_3$ , the color of the sample may develop only partially or rapidly fade, to remove the interference neutralize the sample with diluted HCl or NaOH

## Chlorine, Free High Range

### SPECIFICATIONS

Range	0.00 to 10.00 mg/L (as Cl <sub>2</sub> )
Resolution	0.01 mg/L
Accuracy	±0.03 mg/L ±3% of reading at 25 °C
Wavelength	525 nm
Cuvette type	22 mm diameter
Method	Adaptation of the EPA DPD Method 330.5
Method ID	#017

### REQUIRED REAGENTS

Code	Description	Quantity
HI93701-0	Free Chlorine Reagent	1 packet
HI93734B-0	Free & Total Chlorine Reagent	5 mL

### REAGENT SETS

HI93734-01	Reagents for 100 tests
HI93734-03	Reagents for 300 tests

For other accessories see Accessories section.

### MEASUREMENT PROCEDURE

- Select the **Chlorine Free HR** method using the procedure described in the Factory Methods section.
- Add to the cuvette 5 mL of **HI93734B-0** reagent.
- Fill the cuvette up to the 10 mL mark with 5 mL of unreacted sample. Replace the plastic stopper and the cap. Shake gently for a few seconds.



- Insert the cuvette into the holder and close the lid.
- Press **ZERO**. The display will show “-0-” when the meter is zeroed and ready for measurement.

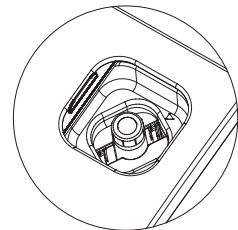

- Remove the cuvette.
- Add one packet of **HI93701-0** Free Chlorine Reagent. Replace the plastic stopper and the cap. Shake gently for 20 seconds.

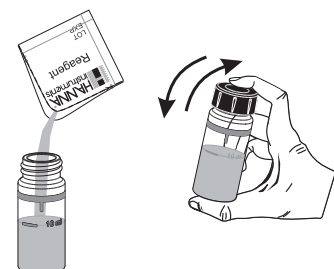

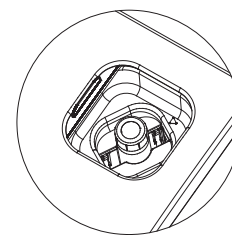

- Insert the cuvette into the holder and close the lid.
- Press the ◀ key to access the timer menu. Press **START** to start Timer 1, the display will show the countdown prior to measurement or wait 1 minute.
- Press **READ** to start the reading. The instrument displays the results in mg/L of chlorine ( $\text{Cl}_2$ ).

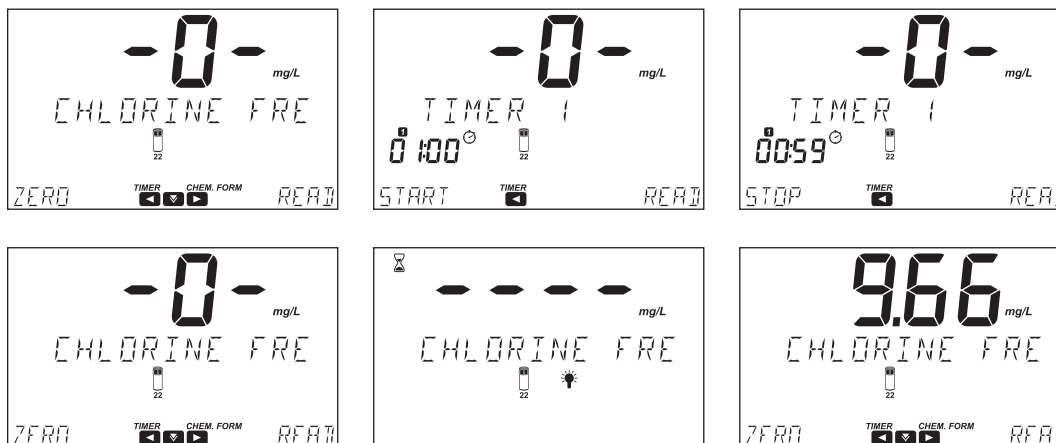

- Press the ▼ key to view the wavelength, method ID, date and time.
- Press the ▶ key to view the chemical formula.

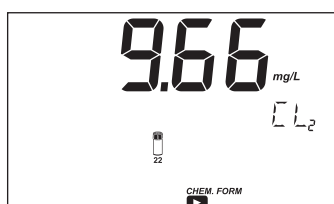

- Press the ▶ key to return to the measurement screen.

## INTERFERENCES

Interference may be caused by:

- Bromine, Chlorine Dioxide, Iodine, Oxidized forms of Chromium and Manganese, Ozone
- Alkalinity greater than 1000 mg/L  $\text{CaCO}_3$  if present as bicarbonate ( $\text{pH} < 8.3$ ), above 25 mg/L  $\text{CaCO}_3$  if present as carbonate ( $\text{pH} > 9.0$ ) or acidity value greater than 150 mg/L  $\text{CaCO}_3$ , the color of the sample may develop only partially or rapidly fade, to remove the interference neutralize the sample with diluted HCl or NaOH
- Hardness greater than 500 mg/L  $\text{CaCO}_3$ , to remove the interference shake the sample for approximately 2 minutes after adding the powder reagent

## Chlorine, Total Ultra Low Range

### SPECIFICATIONS

Range	0.000 to 0.500 mg/L (as Cl <sub>2</sub> )
Resolution	0.001 mg/L
Accuracy	±0.020 mg/L ±3% of reading at 25 °C
Wavelength	525 nm
Cuvette type	22 mm diameter
Method	Adaptation of the EPA DPD Method 330.5
Method ID	#018

### REQUIRED REAGENTS

Code	Description	Quantity
HI95761-0	Total Chlorine Ultra Low Range Reagent	1 packet

### REAGENT SETS

HI95761-01 Reagents for 100 tests

HI95761-03 Reagents for 300 tests

For other accessories see Accessories section.

### MEASUREMENT PROCEDURE

- Select the **Chlorine Total ULR** method using the procedure described in the Factory Methods section.

- Fill the cuvette with 10 mL of unreacted sample (up to the mark).  
Replace the plastic stopper and the cap.



- Insert the cuvette into the holder and close the lid.

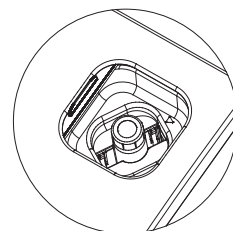

- Press **ZERO**. The display will show “-0-” when the meter is zeroed and ready for measurement.

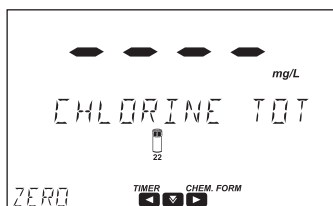

- Remove the cuvette.

- Add one packet of **HI95761-0** Total Chlorine Reagent. Replace the plastic stopper and the cap. Shake gently for 20 seconds.

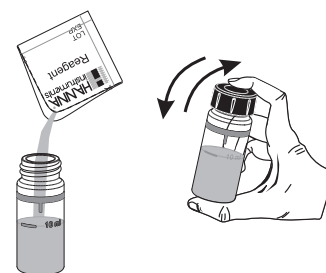

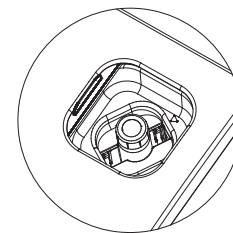

- Insert the cuvette into the holder and close the lid.
- Press the ◀ key to access the timer menu. Press **START** to start Timer 1, the display will show the countdown prior to measurement or wait 2 minutes and 30 seconds.
- Press **READ** to start the reading. The meter displays the results in mg/L of chlorine (Cl<sub>2</sub>).

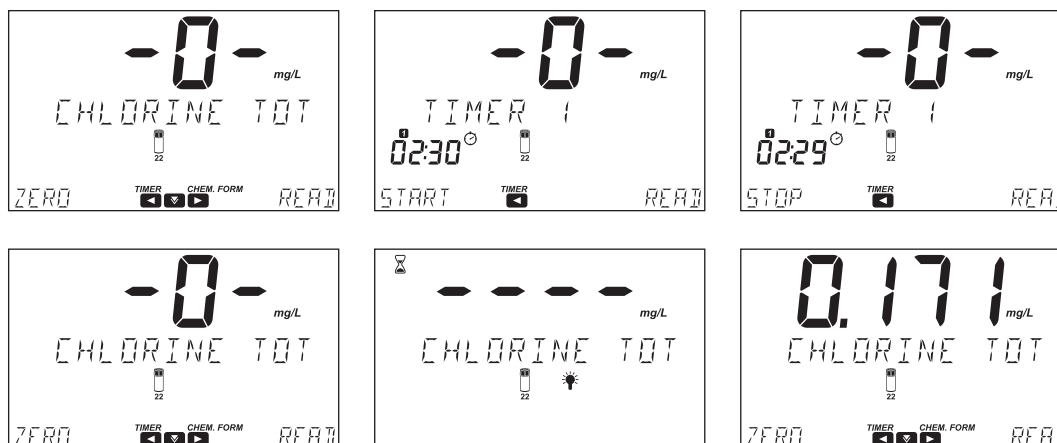

- Press the ▼ key to view the wavelength, method ID, date and time.
- Press the ▶ key to view the chemical formula.

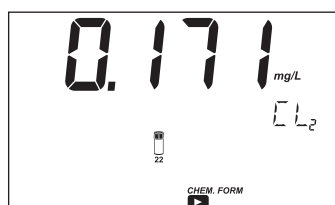

- Press the ▶ key to return to the measurement screen.

## INTERFERENCES

Interference may be caused by:

- Bromine, Chlorine Dioxide, Iodine, Oxidized forms of Chromium and Manganese, Ozone
- Alkalinity greater than 1000 mg/L CaCO<sub>3</sub> if present as bicarbonate (pH < 8.3), above 25 mg/L CaCO<sub>3</sub> if present as carbonate (pH > 9.0) or acidity value greater than 150 mg/L CaCO<sub>3</sub>, the color of the sample may develop only partially or rapidly fade, to remove the interference neutralize the sample with diluted HCl or NaOH
- Hardness greater than 500 mg/L CaCO<sub>3</sub>, to remove the interference shake the sample for approximately 2 minutes after adding the powder reagent

## Chlorine, Total Low Range (Powder Reagent)

### SPECIFICATIONS

Range	0.00 to 5.00 mg/L (as Cl <sub>2</sub> )
Resolution	0.01 mg/L
Accuracy	±0.03 mg/L ± 3% of reading at 25 °C
Wavelength	525 nm
Cuvette type	22 mm diameter
Method	Adaptation of the EPA DPD Method 330.5
Method ID	#019

### REQUIRED REAGENTS

Code	Description	Quantity
HI93711-0	Total Chlorine Reagent	1 packet

### REAGENT SETS

HI93711-01	Reagents for 100 tests (powder)
HI93711-03	Reagents for 300 tests (powder)

For other accessories see Accessories section.

### MEASUREMENT PROCEDURE

- Select the **Chlorine Total LR (POWDER)** method using the procedure described in the Factory Methods section.

- Fill the cuvette with 10 mL of unreacted sample (up to the mark). Replace the plastic stopper and the cap.



- Insert the cuvette into the holder and close the lid.

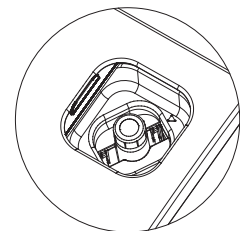

- Press **ZERO**. The display will show “-0-” when the meter is zeroed and ready for measurement.

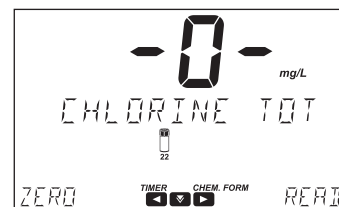
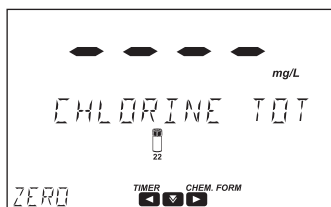

- Remove the cuvette.
- Add one packet of **HI93711-0** Total Chlorine Reagent. Replace the plastic stopper and the cap. Shake gently for 20 seconds.

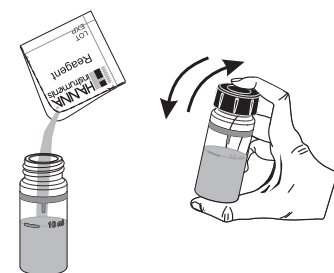



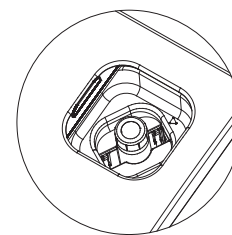

- Insert the cuvette into the holder and close the lid.
- Press the ◀ key to access the timer menu. Press **START** to start Timer 1, the display will show the countdown prior to measurement or wait 2 minutes and 30 seconds.
- Press **READ** to start the reading. The instrument displays the results in mg/L of chlorine ( $\text{Cl}_2$ ).

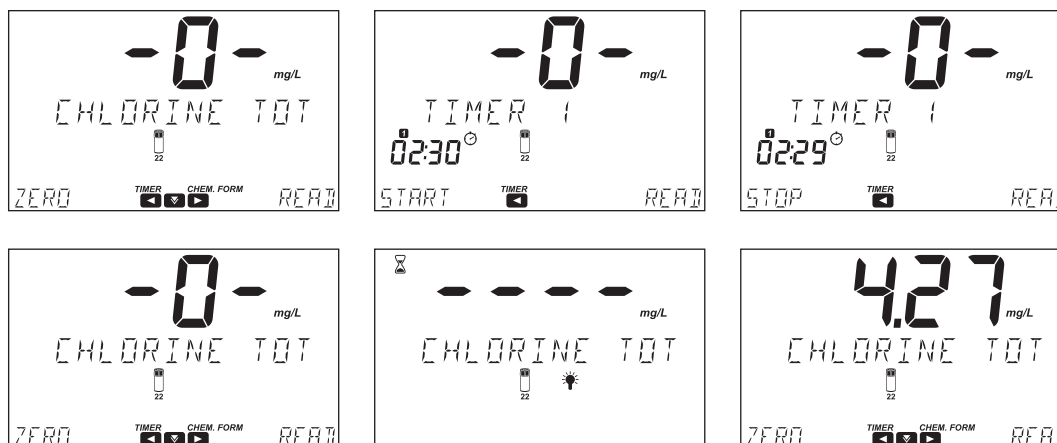

- Press the ▼ key to view the wavelength, method ID, date and time.
- Press the ▶ key to view the chemical formula.

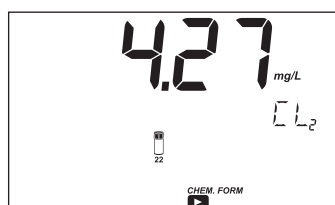

- Press the ▶ key to return to the measurement screen.

**Note:** Free and Total Chlorine have to be measured separately with fresh unreacted samples following the related procedure if both values are desired.

## INTERFERENCES

Interference may be caused by:

- Bromine, Iodine, Oxidized forms of Chromium and Manganese, Ozone
- Hardness greater than 500 mg/L  $\text{CaCO}_3$ , to remove the interference shake the sample for approximately 2 minutes after adding the powder reagent
- Alkalinity greater than 250 mg/L  $\text{CaCO}_3$  or acidity greater than 150 mg/L  $\text{CaCO}_3$ , the color of the sample may develop only partially or may rapidly fade, to remove the interference neutralize the sample with diluted HCl or NaOH

## Chlorine, Total Low Range (Liquid Reagent)

### SPECIFICATIONS

Range	0.00 to 5.00 mg/L (as Cl <sub>2</sub> )
Resolution	0.01 mg/L
Accuracy	±0.03 mg/L ± 3% of reading at 25 °C
Wavelength	525 nm
Cuvette type	22 mm diameter
Method	Adaptation of the EPA DPD Method 330.5
Method ID	#020

### REQUIRED REAGENTS

Code	Description	Quantity
HI93701A-T	Total Chlorine Reagent A	3 drops
HI93701B-T	Total Chlorine Reagent B	3 drops
HI93701C-T	Total Chlorine Reagent C	1 drop

### REAGENT SETS

HI93701-T Reagents for 300 tests (liquid)

For other accessories see Accessories section.

### MEASUREMENT PROCEDURE

- Select the **Chlorine Total LR (LIQUID)** method using the procedure described in the Factory Methods section.

- Fill the cuvette with 10 mL of unreacted sample (up to the mark). Replace the plastic stopper and the cap.



10 mL

- Insert the cuvette into the holder and close the lid.

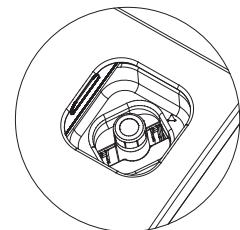

- Press **ZERO**. The display will show “-0-” when the meter is zeroed and ready for measurement.

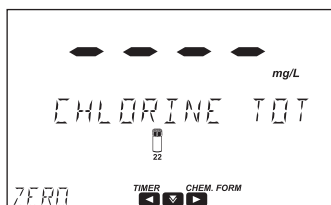

- Remove the cuvette.

- To an empty cuvette add 3 drops of HI93701A-T Total Chlorine Reagent A, 3 drops of HI93701B-T Total Chlorine Reagent B, and 1 drop of HI93701C-T Total Chlorine Reagent C. Replace the plastic stopper and the cap. Swirl gently to mix.

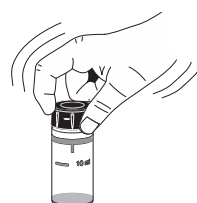
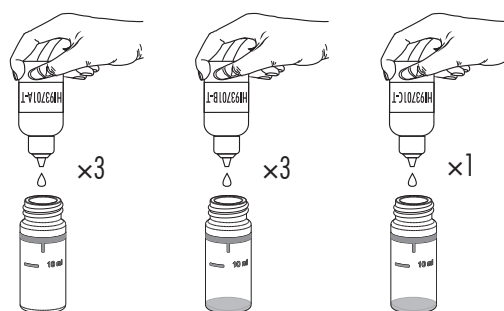

- Add 10 mL of unreacted sample. Replace the plastic stopper and the cap. Shake gently to mix.

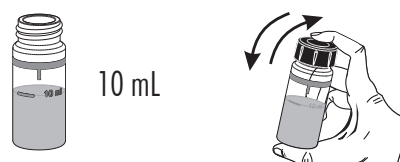

- Insert the cuvette into the holder and close the lid.

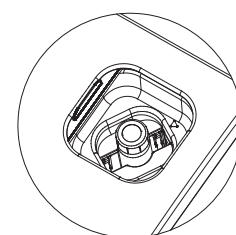

- Press the ◀ key to access the timer menu. Press **START** to start Timer 1, the display will show the countdown prior to measurement or wait 2 minutes and 30 seconds.
- Press **READ** to start the reading. The instrument displays the results in mg/L of chlorine (Cl<sub>2</sub>).

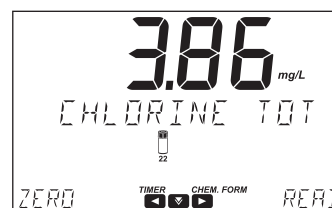
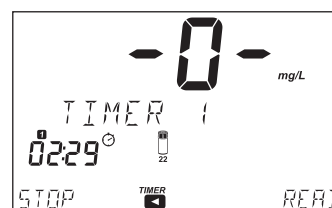
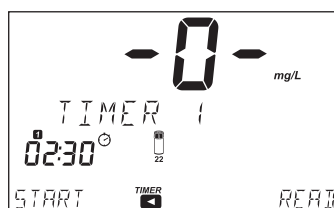

- Press the ▼ key to view the wavelength, method ID, date and time.

- Press the ► key to view the chemical formula.

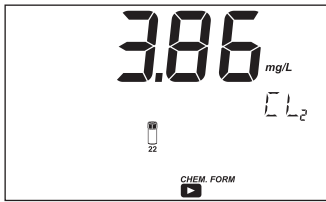

- Press the ► key to return to the measurement screen.

**Note:** Free and Total Chlorine have to be measured separately with fresh unreacted samples following the related procedure if both values are desired.

### INTERFERENCES

Interference may be caused by:

- Bromine, Iodine, Oxidized forms of Chromium and Manganese, Ozone
- Hardness greater than 500 mg/L CaCO<sub>3</sub>, to remove the interference shake the sample for approximately 2 minutes after adding the powder reagent
- Alkalinity greater than 250 mg/L CaCO<sub>3</sub> or acidity greater than 150 mg/L CaCO<sub>3</sub>, the color of the sample may develop only partially or may rapidly fade, to remove the interference neutralize the sample with diluted HCl or NaOH

## Chlorine, Total High Range

### SPECIFICATIONS

Range	0.00 to 10.00 mg/L (as Cl <sub>2</sub> )
Resolution	0.01 mg/L
Accuracy	±0.03 mg/L ±3% of reading at 25 °C
Wavelength	525 nm
Cuvette type	22 mm diameter
Method	Adaptation of the EPA DPD Method 330.5
Method ID	#021

### REQUIRED REAGENTS

Code	Description	Quantity
HI93701-0	Free Chlorine Reagent	1 packet
HI93734B-0	Free & Total Chlorine Reagent	5 mL
HI93734C-0	Total Chlorine Reagent	3 drops

### REAGENT SETS

HI93734-01	Reagents for 100 tests
HI93734-03	Reagents for 300 tests

For other accessories see Accessories section.

### MEASUREMENT PROCEDURE

- Select the **Chlorine Total HR** method using the procedure described in the Factory Methods section.

- Add to the cuvette 5 mL of **HI93734B-0** reagent.



- Fill the cuvette up to the 10 mL mark with 5 mL of unreacted sample. Replace the plastic stopper and the cap. Shake gently for a few seconds.

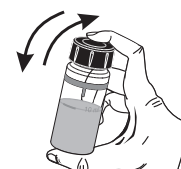

- Insert the cuvette into the holder and close the lid.

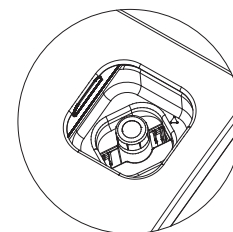

- Press **ZERO**. The display will show “-0-” when the meter is zeroed and ready for measurement.

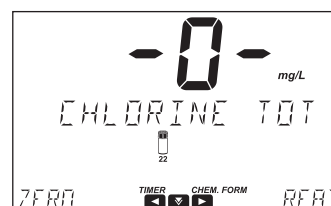

- Remove the cuvette.
- Add 3 drops of **HI93734C-0** reagent to the cuvette.

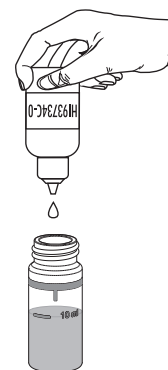

- Add one packet of **HI93701-0** Free Chlorine Reagent. Replace the plastic stopper and the cap. Shake gently for 20 seconds.

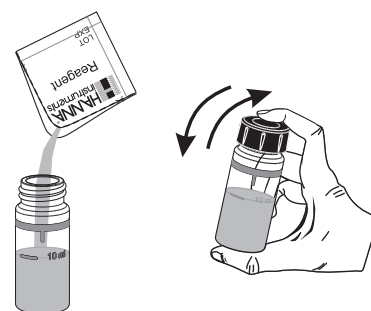

- Insert the cuvette into the holder and close the lid.

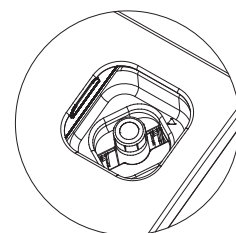

- Press the ◀ key to access the timer menu. Press **START** to start Timer 1, the display will show the countdown prior to measurement or wait 2 minutes and 30 seconds.
- Press **READ** to start the reading. The instrument displays the results in mg/L of chlorine ( $\text{Cl}_2$ ).

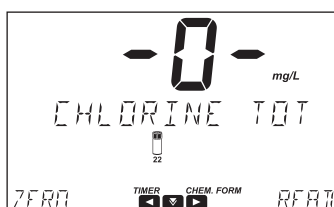
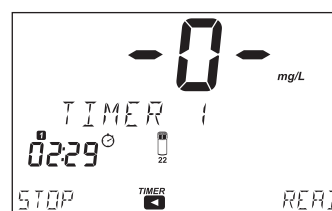
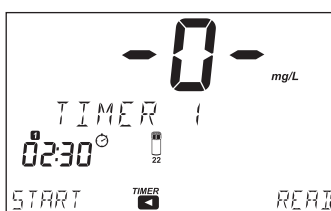
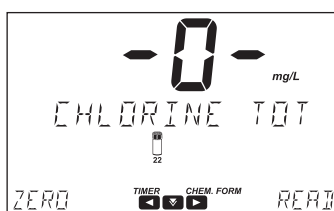

- Press the ▼ key to view the wavelength, method ID, date and time.

- Press the ► key to view the chemical formula.

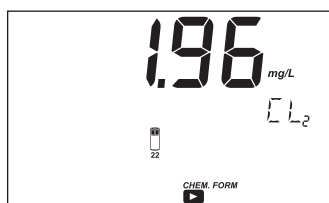

- Press the ► key to return to the measurement screen.

### INTERFERENCES

- Bromine, Chlorine Dioxide, Iodine, Oxidized forms of Chromium and Manganese, Ozone
- Alkalinity greater than 1000 mg/L CaCO<sub>3</sub> if present as bicarbonate (pH < 8.3), above 25 mg/L CaCO<sub>3</sub> if present as carbonate (pH > 9.0) or acidity value greater than 150 mg/L CaCO<sub>3</sub>, the color of the sample may develop only partially or rapidly fade, to remove the interference neutralize the sample with diluted HCl or NaOH
- Hardness greater than 500 mg/L CaCO<sub>3</sub>, to remove the interference shake the sample for approximately 2 minutes after adding the powder reagent

## Chlorine, Total Ultra High Range

### SPECIFICATIONS

Range	0 to 500 mg/L (as Cl <sub>2</sub> )
Resolution	1 mg/L
Accuracy	±3 mg/L ±3% of reading at 25 °C
Wavelength	525 nm
Cuvette type	22 mm diameter
Method	Adaptation of the Standard Methods for Examination of Water and Wastewater, 20 <sup>th</sup> Edition, 4500-Cl
Method ID	#022

### REQUIRED REAGENTS

Code	Description	Quantity
HI95771A-0	Total Chlorine Ultra High Range Reagent A	1 packet
HI95771B-0	Total Chlorine Ultra High Range Reagent B	1 packet

### REAGENT SETS

HI95771-01	Reagents for 100 tests
HI95771-03	Reagents for 300 tests

For other accessories see Accessories section.

### MEASUREMENT PROCEDURE

- Select the **Chlorine Total UHR** method using the procedure described in the Factory Methods section.

- Fill the cuvette with 10 mL of unreacted sample (up to the mark).  
Replace the plastic stopper and the cap.



10 mL

- Insert the cuvette into the holder and close the lid.

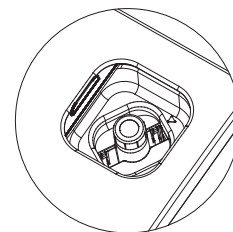

- Press **ZERO**. The display will show “-0-” when the meter is zeroed and ready for measurement.

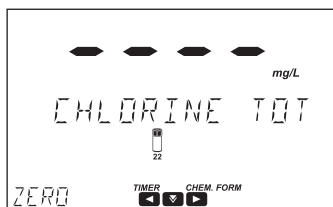

- Remove the cuvette.



- Add one packet of **HI95771A-0** Total Chlorine Ultra High Range Reagent A and one packet **HI95771B-0** Total Chlorine Ultra High Range Reagent B. Replace the plastic stopper and the cap. Shake gently for 20 seconds.

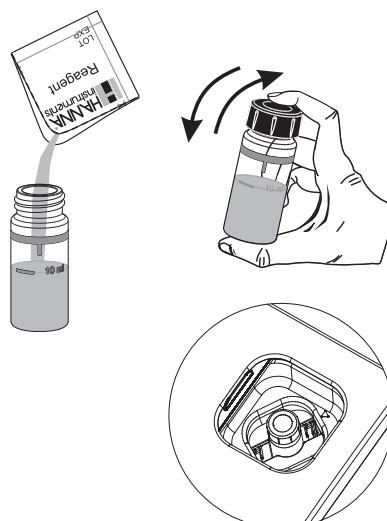

- Insert the cuvette into the holder and close the lid.
- Press the ◀ key to access the timer menu. Press **START** to start Timer 1, the display will show the countdown prior to measurement or wait 2 minutes and 30 seconds.

**Note:** After 1 minute invert the cuvette 5 times.



- Press **READ** to start the reading. The instrument displays the results in mg/L of chlorine ( $\text{Cl}_2$ ).

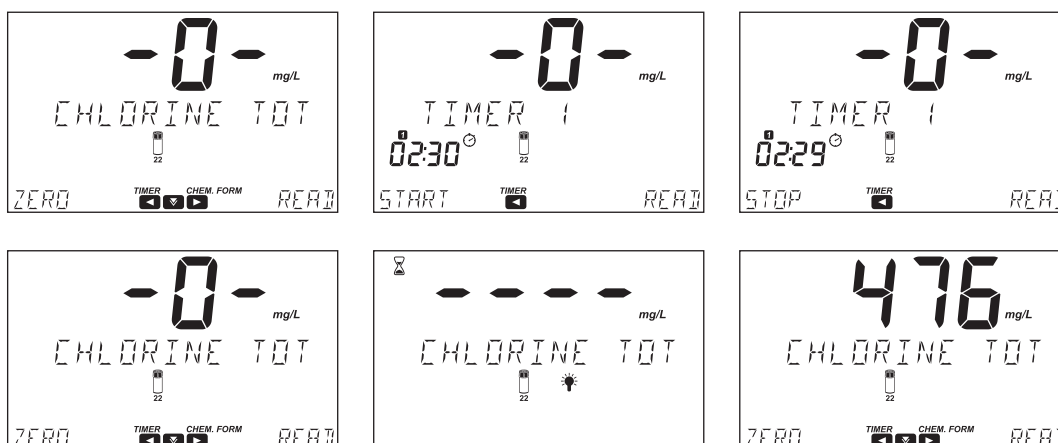

- Press the ✓ key to view the wavelength, method ID, date and time.
- Press the ▶ key to view the chemical formula.

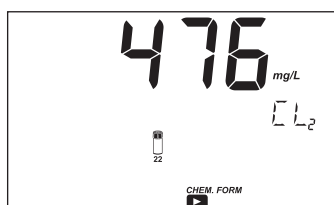

- Press the ▶ key to return to the measurement screen.

## INTERFERENCES

Interference may be caused by:

- Bromine ( $\text{Br}_2$ ), Iodine ( $\text{I}_2$ ), Chlorine Dioxide ( $\text{ClO}_2$ ), Oxidized Chromium and Manganese and Ozone ( $\text{O}_3$ )

## Chromium (VI) Low Range

### SPECIFICATIONS

Range	0 to 300 $\mu\text{g/L}$ (as Cr(VI))
Resolution	1 $\mu\text{g/L}$
Accuracy	$\pm 10 \mu\text{g/L} \pm 4\%$ of reading at 25 °C
Wavelength	535 nm
Cuvette type	22 mm diameter
Method	Adaptation of the ASTM Manual of Water and Environmental Technology, D1687 Diphenylcarbohydrazide Method
Method ID	#023

### REQUIRED REAGENTS

Code	Description	Quantity
HI93749-0	Chromium (VI) Low Range Reagent	1 packet

### REAGENT SETS

HI93749-01 Reagents for 100 tests

HI93749-03 Reagents for 300 tests

For other accessories see Accessories section.

### MEASUREMENT PROCEDURE

- Select the **Chromium (VI) LR** method using the procedure described in the Factory Methods section.

- Fill the cuvette with 10 mL of unreacted sample (up to the mark). Replace the plastic stopper and the cap.

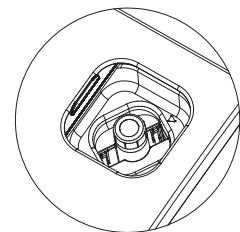

- Insert the cuvette into the holder and close the lid.

- Press **ZERO**. The display will show “-0-” when the meter is zeroed and ready for measurement.

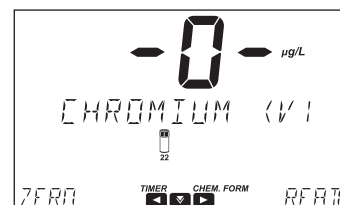
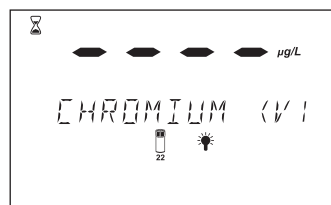
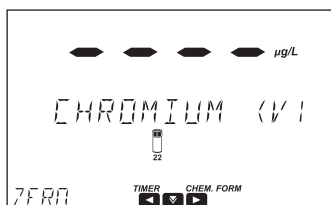

- Remove the cuvette.
- Add one packet of **HI93749-0** Chromium (VI) Low Range Reagent. Replace the plastic stopper and the cap. Shake vigorously for about 10 seconds.

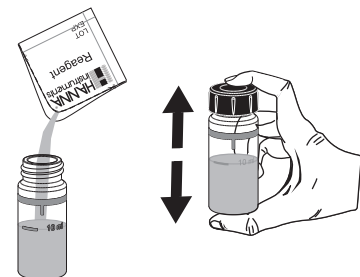

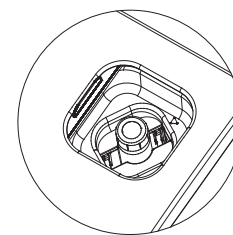

- Insert the cuvette into the holder and close the lid.
- Press the ◀ key to access the timer menu. Press **START** to start Timer 1, the display will show the countdown prior to measurement or wait 6 minutes.
- Press **READ** to start the reading. The instrument displays the results in  $\mu\text{g/L}$  of chromium ( $\text{Cr}^{6+}$ ).

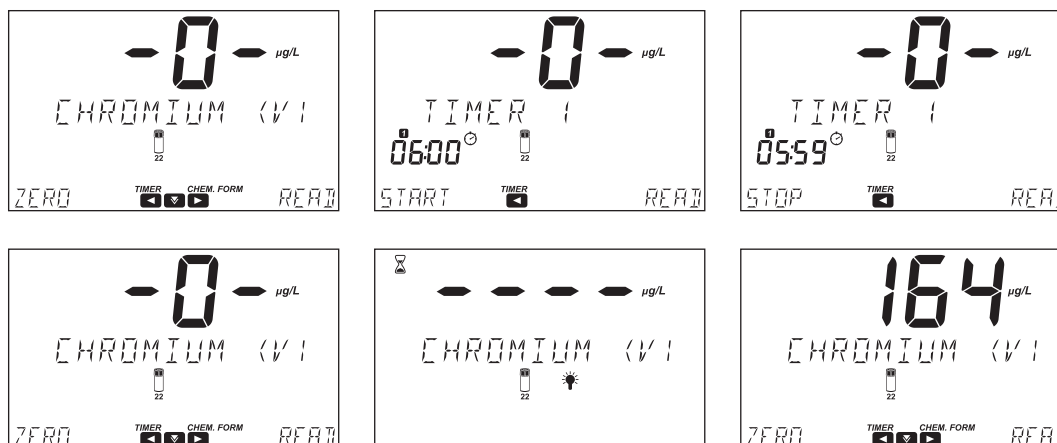

- Press the ▼ key to view the wavelength, method ID, date and time.
- Press the ▶ key to view the chemical formula.
- Press the ▲ key to convert the results to  $\mu\text{g/L}$  of chromate ( $\text{CrO}_4^{2-}$ ) or dichromate ( $\text{Cr}_2\text{O}_7^{2-}$ ).

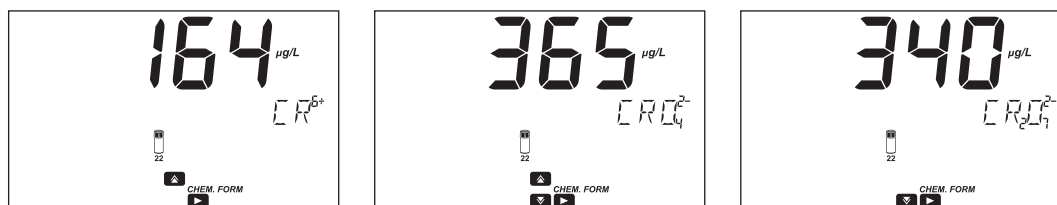

- Press the ▶ key to return to the measurement screen.

## INTERFERENCES

Interference may be caused by:

- Vanadium above 1 mg/L, wait 10 minutes before reading to remove the interference
- Iron above 1 mg/L
- Mercurous and mercuric ions slight inhibition of the reaction

## Chromium (VI) High Range

### SPECIFICATIONS

Range	0 to 1000 $\mu\text{g/L}$ (as Cr(VI))
Resolution	1 $\mu\text{g/L}$
Accuracy	$\pm 5 \mu\text{g/L} \pm 4\%$ of reading at 25 °C
Wavelength	535 nm
Cuvette type	22 mm diameter
Method	Adaptation of the ASTM Manual of Water and Environmental Technology, D1687-92, Diphenylcarbohydrazide Method
Method ID	#024

### REQUIRED REAGENTS

Code	Description	Quantity
HI93723-0	Chromium (VI) High Range Reagent	1 packet

### REAGENT SETS

HI93723-01 Reagents for 100 tests

HI93723-03 Reagents for 300 tests

For other accessories see Accessories section.

### MEASUREMENT PROCEDURE

- Select the **Chromium (VI) HR** method using the procedure described in the Factory Methods section.

- Fill the cuvette with 10 mL of unreacted sample (up to the mark). Replace the plastic stopper and the cap.

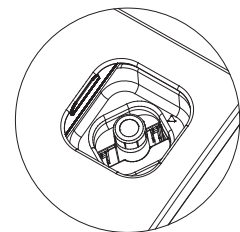

- Insert the cuvette into the holder and close the lid.

- Press **ZERO**. The display will show “-0-” when the meter is zeroed and ready for measurement.

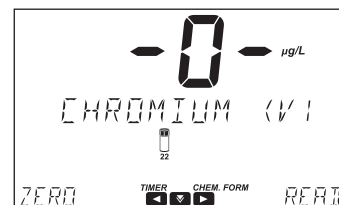
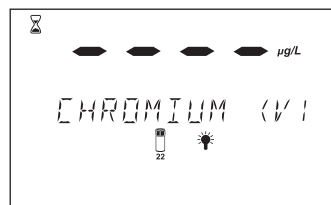
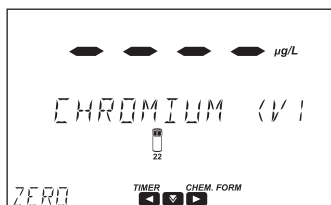

- Remove the cuvette.
- Add one packet of **HI93723-0** Chromium (VI) High Range Reagent. Replace the plastic stopper and the cap. Shake vigorously for about 10 seconds.

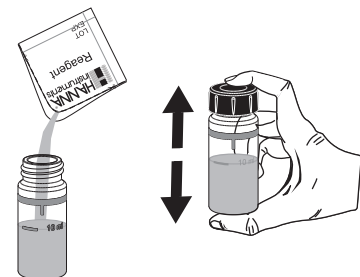

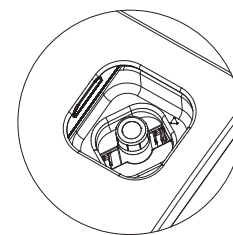

- Insert the cuvette into the holder and close the lid.
- Press the ◀ key to access the timer menu. Press **START** to start Timer 1, the display will show the countdown prior to measurement or wait 6 minutes.
- Press **READ** to start the reading. The instrument displays the results in  $\mu\text{g/L}$  of chromium ( $\text{Cr}^{6+}$ ).

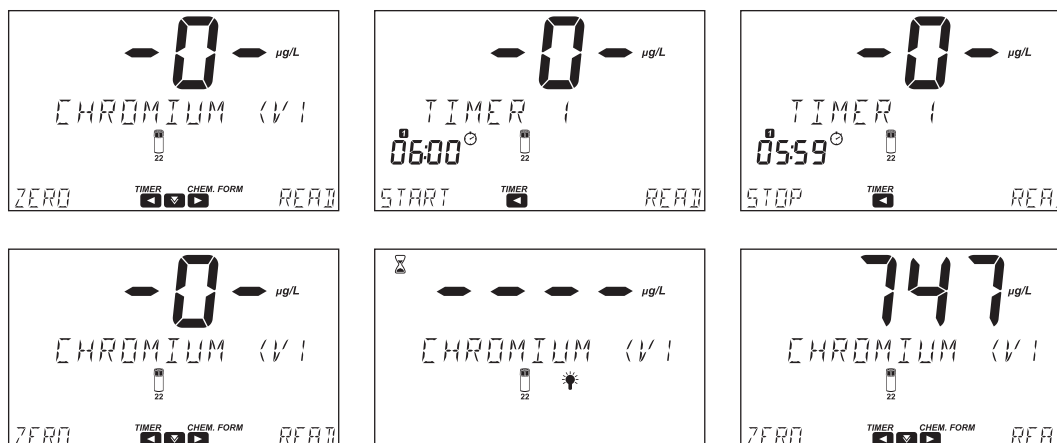

- Press the ▼ key to view the wavelength, method ID, date and time.
- Press the ▶ key to view the chemical formula.
- Press the ▲ key to convert the results to  $\mu\text{g/L}$  of chromate ( $\text{CrO}_4^{2-}$ ) or dichromate ( $\text{Cr}_2\text{O}_7^{2-}$ ).

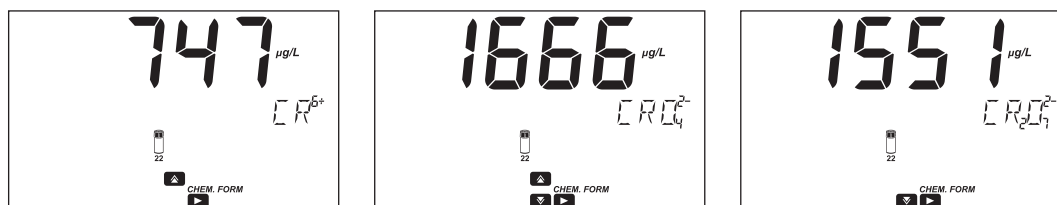

- Press the ▶ key to return to the measurement screen.

## INTERFERENCES

Interference may be caused by:

- Vanadium above 1 mg/L, wait 10 minutes before reading to remove the interference
- Iron above 1 mg/L
- Mercurous and mercuric ions slight inhibition of the reaction

## Chromium (VI)/Total (13 mm Vial)

### SPECIFICATIONS

Range	0 to 1000 $\mu\text{g/L}$ (as Cr)
Resolution	1 $\mu\text{g/L}$
Accuracy	$\pm 10 \mu\text{g/L} \pm 3\%$ of reading
Wavelength	525 nm
Cuvette type	13 mm diameter
Method	Adaptation of the Standard Methods of the Examination of Water and Wastewater, 22 <sup>nd</sup> Edition, 3500-Cr, Diphenylcarbazide Method
Method ID	#087

### REQUIRED REAGENT

Code	Description	Quantity
HI96781V-0*	Chromium Digestion Vial	1 vial
HI96781A-0	Chromium Reagent A	1 packet
HI96781B-0	Chromium Reagent B	1 packet

\*Reagent vial identification: Cr, red label

### REAGENT SETS

HI96781-25 Reagents for 25 tests

For other accessories see Accessories section.

**Note:** Store the unused vials in their packaging in a cool and dark place.

### PRINCIPLE

The chromium in the sample is oxidized to hexavalent chromium during digestion. The hexavalent chromium reacts with the Diphenylcarbazide to form a red color proportional to the amount of chromium in the sample. This method has a strong temperature and pH dependence. The sample temperature must be between 18 and 22 °C and the pH between 3 and 9.

### APPLICATION

Water, wastewater, process control

### SIGNIFICANCE & USE

Chromium(III) is an essential element for humans and can be metabolized in the body. Chromium(III) is found naturally in fruit, vegetables, meat and grains. Chromium(VI) has been identified as a carcinogen and can alter genetic material. Chromium(VI) is discharged from steel and paper mills or through the oxidation of chromium(III). Chromium(VI) has been a regulated drinking water contaminate since the 1940s, the EPA only regulates total chromium.

### MEASUREMENT PROCEDURE

#### CHROMIUM TOTAL



Before using the reagent kit carefully read all the instructions and the Safety Data Sheets (SDS). Pay particular attention to all warnings, cautions and notes. Failure to do so may result in serious injury to the operator.

The acidification of the sample may result in the release of toxic gas, such as cyanides and sulfides. Sample preparation and digestion should be done in a fume hood.

- Preheat the Hanna<sup>®</sup> Reactor [HI839800](#) to 105 °C (221 °F). The optional [HI740217](#) safety shield is strongly recommended.

**Warning:** Do not use an oven or microwave! Samples may leak and generate a corrosive and possibly explosive atmosphere.

- Remove the cap from a [HI96781V-0](#) Chromium Digestion Vial.
- Add 5 mL of sample to the vial, while keeping the vial at a 45-degree angle.

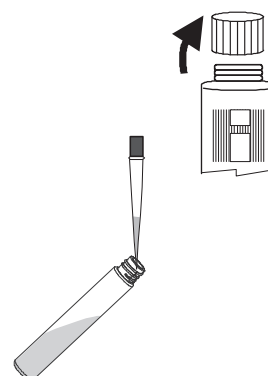

- Add one packet of [HI96781A-0](#) Chromium Reagent A to the vial. Replace the cap and invert for 30 seconds.

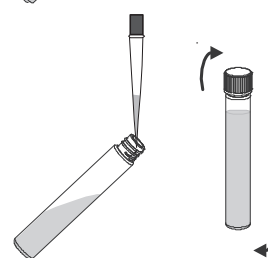

- Insert the vial into the reactor and heat it for 60 minutes at 105 °C.



- At the end of the digestion period switch off the reactor. Allow the vials to cool to room temperature. Invert each vial several times and place them in the test tube rack.

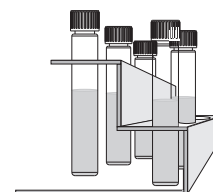

- Select the [CHROMIUM \(VI\)/TOTAL \(13 mm\)](#) method using the procedure described in the Factory Methods section.

- Insert the 13 mm vial adapter using the procedure described in the Cuvette & Vial Adapters section.

- Insert the vial into the adapter.

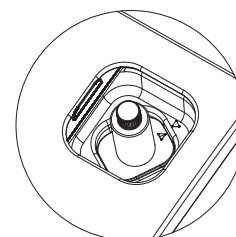

- Press **ZERO**. The display will show “-0-” when the meter is zeroed and ready for measurement.

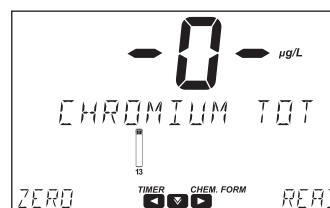
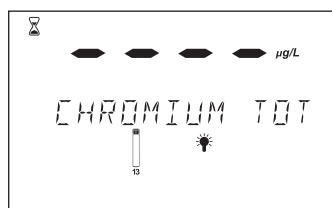
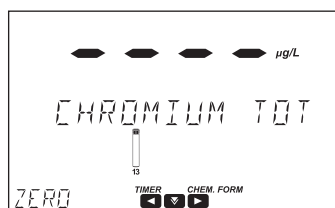

- Remove the vial.
- Add one packet of **HI96781B-0** Chromium Reagent B. Replace the cap. Shake vigorously for 1 minute.

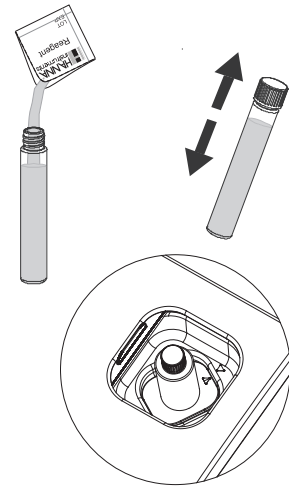

- Insert the vial into the adapter.
- Press the ◀ key to access the timer menu. Press **START** to start Timer 1, the display will show the countdown prior to measurement or wait 6 minutes.
- Press **READ** to start the reading. The instrument displays the results in  $\mu\text{g/L}$  of chromium (Cr).

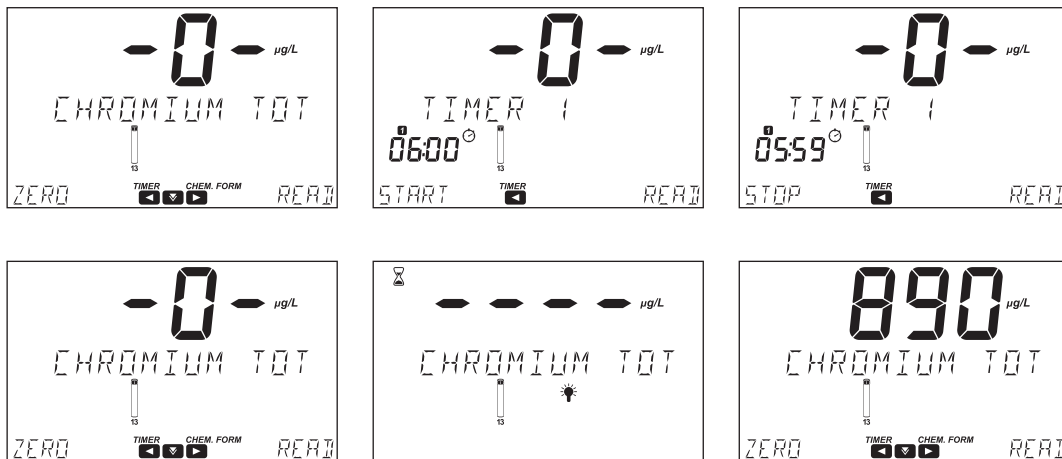

### CHROMIUM(VI)

- Remove the cap from a **HI96781V-0** Chromium Digestion Vial.
- Add 5 mL of sample to the vial, while keeping the vial at a 45-degree angle. Replace the cap and invert several times to mix.
- Select the **CHROMIUM (VI)/TOTAL (13 mm)** method using the procedure described in the Factory Methods section.
- Insert the 13 mm vial adapter using the procedure described in the Cuvette & Vial Adapters section.
- Insert the vial into the adapter.

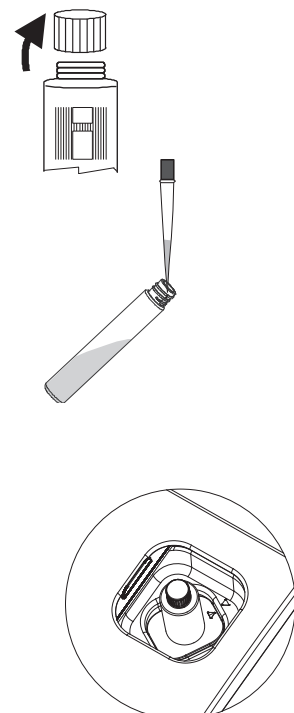



- Press **ZERO**. The display will show “-0-” when the meter is zeroed and ready for measurement.

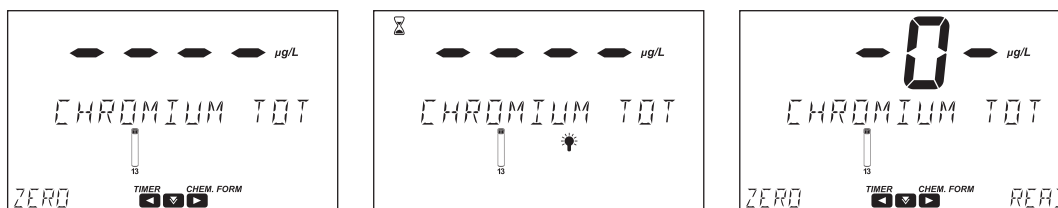

- Remove the cap and add one packet of **HI96781B-0** Chromium Reagent B. Replace the cap. Shake vigorously for 1 minute.

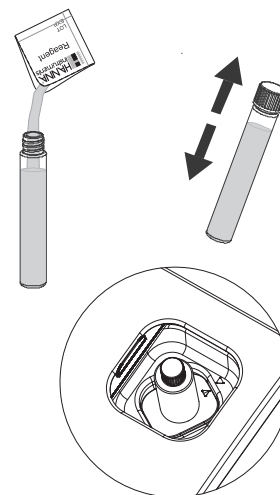

- Insert the vial into the adapter.
- Press the **◀** key to access the timer menu. Press **START** to start Timer 1, the display will show the countdown prior to measurement or wait 6 minutes.
- Press **READ** to start the reading. The instrument displays the results in  $\mu\text{g/L}$  of chromium (Cr).

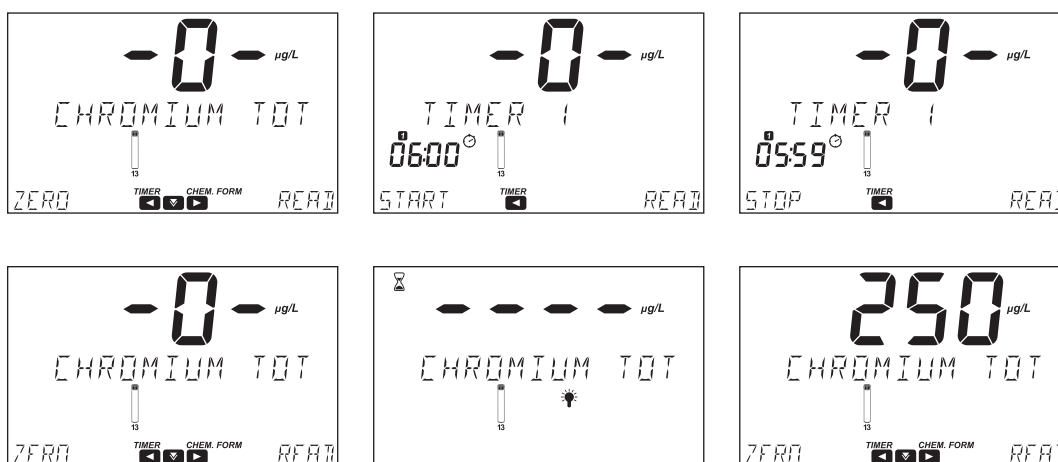

- To determine the Chromium(III) concentration, subtract the results from the Chromium(VI) procedure from the Chromium Total procedure.

## INTERFERENCES

Interference may be caused by:

- Large amounts of iron, copper or reducing and oxidizing agents yield falsely low readings
- Nitrate, Potassium, Sulfate above 2000 mg/L
- Chloride, Sodium above 1000 mg/L
- Calcium above 125 mg/L
- Ammonium, Magnesium above 100 mg/L
- Nickel, Zinc above 25 mg/L
- Copper, Iron above 10 mg/L

## Chemical Oxygen Demand Low Range EPA (13 mm Vial)

### SPECIFICATIONS

Range	0 to 150 mg/L (as O <sub>2</sub> )
Resolution	1 mg/L
Accuracy	± 5 mg/L or ± 4% of reading at 25 °C, whichever is greater
Wavelength	420 nm
Cuvette type	13 mm diameter
Method	Adaptation of the EPA 410.4 Approved Method for the COD Determination on Surface Waters and Wastewaters
Method ID	#025

### REQUIRED REAGENTS

Code	Description	Quantity
HI93754A-0*	COD Low Range Reagent Vial	2 vials
DEIONIZED120	Deionized Water	2 mL

\*Reagent vial identification: COD A, red label

### REAGENT SETS

HI93754A-25 Reagents for 24 tests

For other accessories see Accessories section.

**Note:** Store the unused vials in their packaging in a cool and dark place.

### MEASUREMENT PROCEDURE



Before using the reagent kit carefully read all the instructions and the Safety Data Sheets (SDS). Pay particular attention to all warnings, cautions and notes. Failure to do so may result in serious injury to the operator.

**Reagent Blank Correction:** This method requires a reagent blank correction. A single blank vial may be used more than once. The blank vial is stable for several months at room temperature. For improved accuracy, run a blank for each set of measurements and always use the same lot of reagents for blank and samples.

- Choose a homogeneous sample. Samples containing solids capable of settling need to be homogenized with a blender.
- Preheat the Hanna<sup>®</sup> Reactor HI839800 to 150 °C (302 °F). The optional HI740217 safety shield is strongly recommended. Do not use an oven or microwave; samples may leak and generate a corrosive and possibly explosive atmosphere.
- Remove the cap from two HI93754A-0 COD Low Range Reagent Vials.



- Add 2 mL of deionized water to the first vial (#1) and 2 mL of sample to the second vial (#2), while keeping the vials at a 45-degree angle. Replace the cap and invert several times to mix.

**Warning:** The vials will become hot during mixing, use caution when handling.

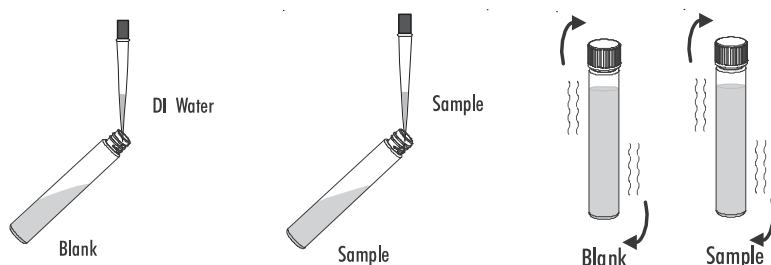

- Insert the vials into the reactor and heat them for 2 hours at 150 °C.
- At the end of the digestion period switch off the reactor. Wait 20 minutes to allow the vials to cool to about 120 °C.
- Invert each vial several times while still warm, then place them in the test tube rack.



**Warning:** The vials are still hot, use caution when handling.

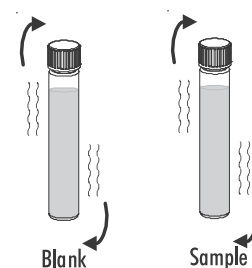

- Leave the vials in the tube rack to cool to room temperature. Do not shake or invert them, the samples may become turbid.
- Select **COD LR EPA (13 mm)** method using the procedure described in the Factory Methods section.
- Insert the 13 mm vial adapter using the procedure described in the Cuvette & Vial Adapters section.
- Insert the blank vial (#1) into the adapter.

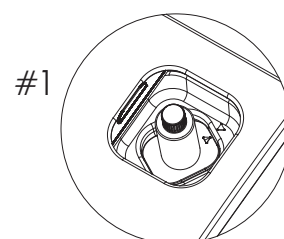

- Press **ZERO**. The display will show “-0-” when the meter is zeroed and ready for measurement.

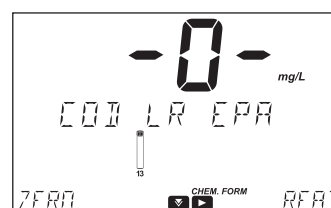
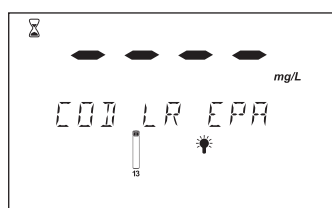
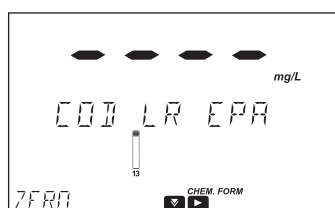

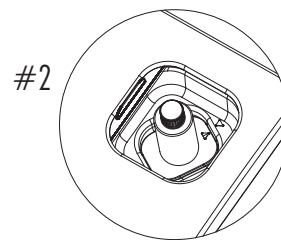

- Remove the vial.
- Insert the sample vial (#2) into the adapter.

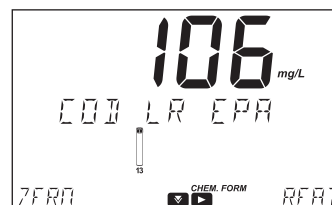
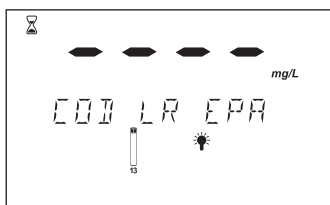
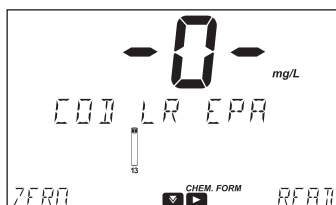

- Press **READ** to start the reading. The instrument displays the results in mg/L of oxygen (O<sub>2</sub>).



- Press the  key to view the wavelength, method ID, date and time.
- Press the  key to view the chemical formula.

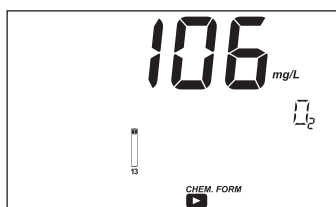

- Press the  key to return to the measurement screen.

### INTERFERENCES

Interference may be caused by:

- Chloride (Cl<sup>-</sup>) above 2000 mg/L. Samples with higher chloride concentration should be diluted

## Chemical Oxygen Demand Low Range Mercury Free (13 mm Vial)

### SPECIFICATIONS

Range	0 to 150 mg/L (as O <sub>2</sub> )
Resolution	1 mg/L
Accuracy	± 5 mg/L or ± 4% of reading at 25 °C, whichever is greater
Wavelength	420 nm
Cuvette type	13 mm diameter
Method	Dichromate Mercury Free
Method ID	#026

### REQUIRED REAGENTS

Code	Description	Quantity
HI93754D-0*	COD Low Range Reagent Vial	2 vials
DEIONIZED120	Deionized Water	2 mL

\*Reagent vial identification: COD D, red label

### REAGENT SETS

HI93754D-25 Reagents for 24 tests

For other accessories see Accessories section.

**Note:** Store the unused vials in their packaging in a cool and dark place.

### MEASUREMENT PROCEDURE



Before using the reagent kit carefully read all the instructions and the Safety Data Sheets (SDS). Pay particular attention to all warnings, cautions and notes. Failure to do so may result in serious injury to the operator.

**Reagent Blank Correction:** This method requires a reagent blank correction. A single blank vial may be used more than once. The blank vial is stable for several months at room temperature. For improved accuracy, run a blank for each set of measurements and always use the same lot of reagents for blank and samples.

- Choose a homogeneous sample. Samples containing solids capable of settling need to be homogenized with a blender.
- Preheat the Hanna<sup>®</sup> Reactor HI839800 to 150 °C (302 °F). The optional HI740217 safety shield is strongly recommended. Do not use an oven or microwave; samples may leak and generate a corrosive and possibly explosive atmosphere.
- Remove the cap from two HI93754D-0 COD Low Range Reagent Vials.



- Add 2 mL of deionized water to the first vial (#1) and 2 mL of sample to the second vial (#2), while keeping the vials at a 45-degree angle. Replace the cap and invert several times to mix.

**Warning:** The vials will become hot during mixing, use caution when handling.

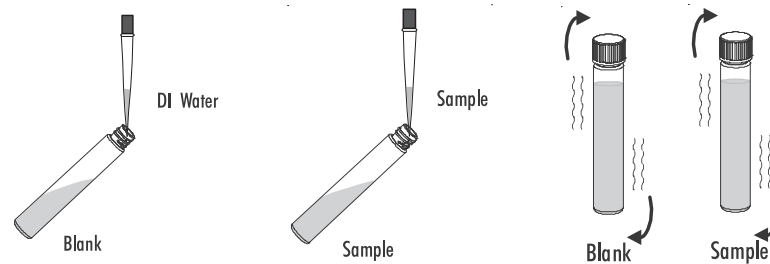

- Insert the vials into the reactor and heat them for 2 hours at 150 °C.
- At the end of the digestion period switch off the reactor. Wait 20 minutes to allow the vials to cool to about 120 °C.
- Invert each vial several times while still warm, then place them in the test tube rack.

**Warning:** The vials are still hot, use caution when handling.

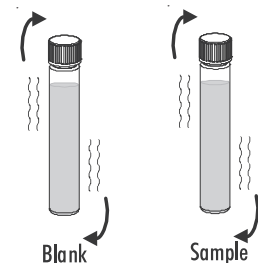

- Leave the vials in the tube rack to cool to room temperature. Do not shake or invert them, the samples may become turbid.
- Select **COD LR Hg Free (13 mm)** method using the procedure described in the Factory Methods section.
- Insert the 13 mm vial adapter using the procedure described in the Cuvette & Vial Adapters section.
- Insert the blank vial (#1) into the adapter.

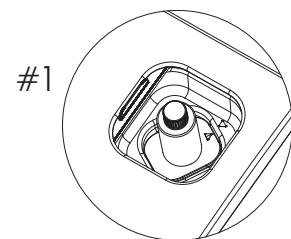
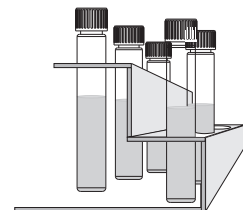

- Press **ZERO**. The display will show “-0-” when the meter is zeroed and ready for measurement.

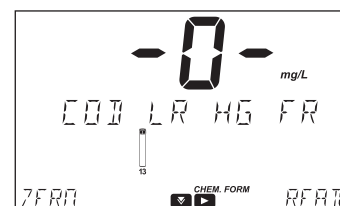
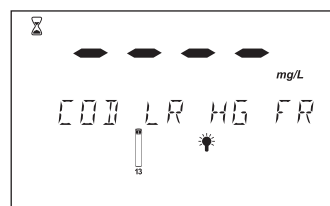
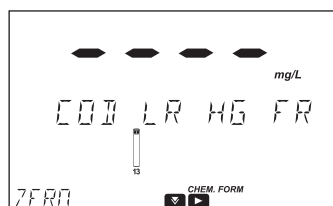

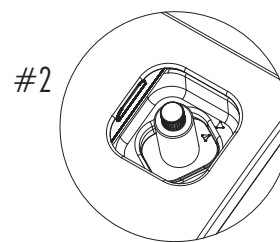

- Remove the vial.
- Insert the sample vial (#2) into the adapter.

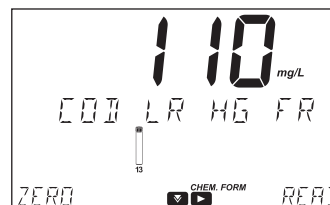
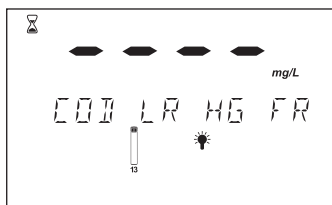
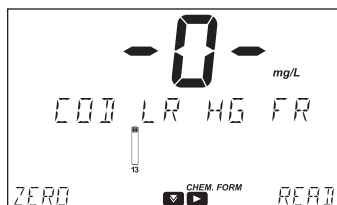

- Press **READ** to start the reading. The instrument displays the results in **mg/L of oxygen (O<sub>2</sub>)**.



- Press the  key to view the wavelength, method ID, date and time.
- Press the  key to view the chemical formula.

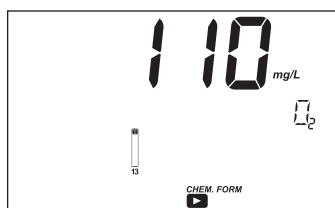

- Press the  key to return to the measurement screen.

## INTERFERENCES

Interference may be caused by:

- Chloride (Cl<sup>-</sup>) above 2000 mg/L. Samples with higher chloride concentration should be diluted

## Chemical Oxygen Demand Low Range ISO (13 mm Vial)

### SPECIFICATIONS

Range	0 to 150 mg/L (as O <sub>2</sub> )
Resolution	1 mg/L
Accuracy	± 5 mg/L or ± 4% of reading at 25 °C, whichever is greater
Wavelength	420 nm
Cuvette type	13 mm diameter
Method	Dichromate ISO
Method ID	#027

### REQUIRED REAGENTS

Code	Description	Quantity
HI93754F-0*	COD Low Range Reagent Vial	2 vials
DEIONIZED120	Deionized Water	2 mL

\*Reagent vial identification: COD F, red label

### REAGENT SETS

HI93754F-25 Reagents for 24 tests

For other accessories see Accessories section.

**Note:** Store the unused vials in their packaging in a cool and dark place.

### MEASUREMENT PROCEDURE



Before using the reagent kit carefully read all the instructions and the Safety Data Sheets (SDS). Pay particular attention to all warnings, cautions and notes. Failure to do so may result in serious injury to the operator.

**Reagent Blank Correction:** This method requires a reagent blank correction. A single blank vial may be used more than once. The blank vial is stable for several months at room temperature. For improved accuracy, run a blank for each set of measurements and always use the same lot of reagents for blank and samples.

- Choose a homogeneous sample. Samples containing solids capable of settling need to be homogenized with a blender.
- Preheat the Hanna<sup>®</sup> Reactor HI839800 to 150 °C (302 °F). The optional HI740217 safety shield is strongly recommended. Do not use an oven or microwave; samples may leak and generate a corrosive and possibly explosive atmosphere.
- Remove the cap from two HI93754F-0 COD Low Range Reagent Vials.



#1



#2



- Add 2 mL of deionized water to the first vial (#1) and 2 mL of sample to the second vial (#2), while keeping the vials at a 45-degree angle. Replace the cap and invert several times to mix.

**Warning:** The vials will become hot during mixing, use caution when handling.

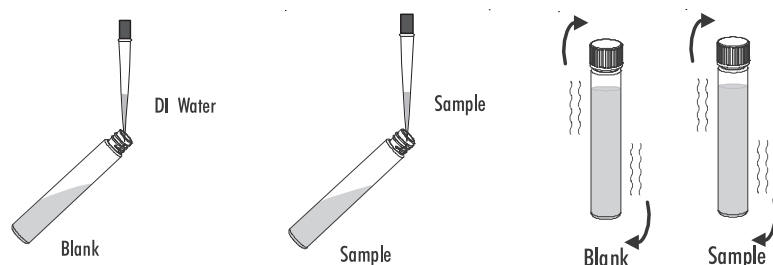

- Insert the vials into the reactor and heat them for 2 hours at 150 °C.
- At the end of the digestion period switch off the reactor. Wait 20 minutes to allow the vials to cool to about 120 °C.
- Invert each vial several times while still warm, then place them in the test tube rack.

**Warning:** The vials are still hot, use caution when handling.

- Leave the vials in the tube rack to cool to room temperature. Do not shake or invert them, the samples may become turbid.
- Select **COD LR ISO (13 mm)** method using the procedure described in the Factory Methods section.
- Insert the 13 mm vial adapter using the procedure described in the Cuvette & Vial Adapters section.
- Insert the blank vial (#1) into the adapter.

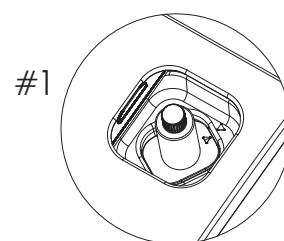
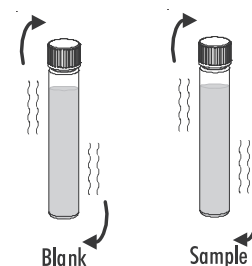

- Press **ZERO**. The display will show “-0-” when the meter is zeroed and ready for measurement.

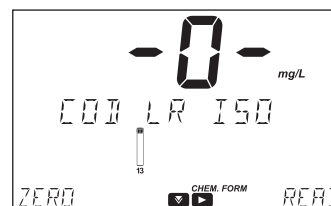
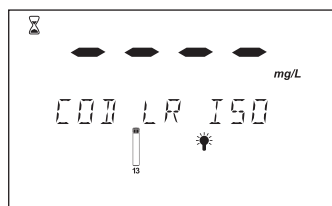
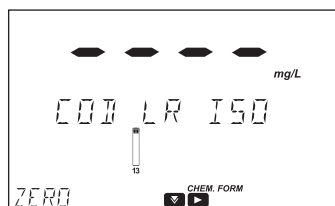

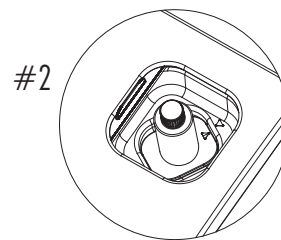

- Remove the vial.
- Insert the sample vial (#2) into the adapter.

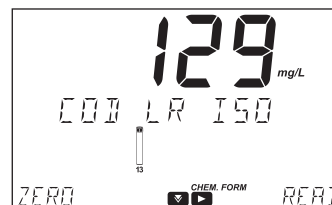
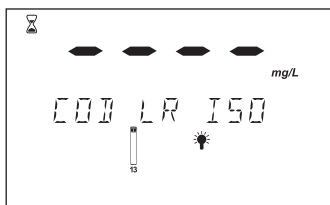
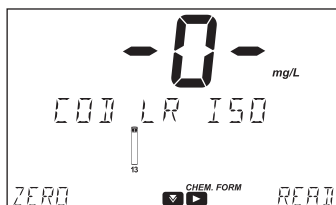

- Press **READ** to start the reading. The instrument displays the results in **mg/L of oxygen (O<sub>2</sub>)**.



- Press the  key to view the wavelength, method ID, date and time.
- Press the  key to view the chemical formula.

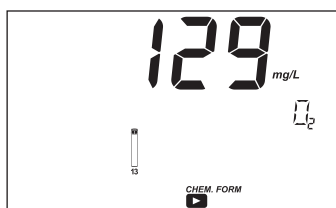

- Press the  key to return to the measurement screen.

### INTERFERENCES

Interference may be caused by:

- Chloride (Cl<sup>-</sup>) above 2000 mg/L. Samples with higher chloride concentration should be diluted

## Chemical Oxygen Demand Medium Range EPA (13 mm Vial)

### SPECIFICATIONS

Range	0 to 1500 mg/L (as O <sub>2</sub> )
Resolution	1 mg/L
Accuracy	± 15 mg/L or ± 3% of reading at 25 °C, whichever is greater
Wavelength	610 nm
Cuvette type	13 mm diameter
Method	Adaptation of the EPA 410.4 Approved Method for the COD Determination on Surface Waters and Wastewaters
Method ID	#028

### REQUIRED REAGENTS

Code	Description	Quantity
HI93754B-0*	COD Medium Range Reagent Vial	2 vials
DEIONIZED120	Deionized Water	2 mL

\*Reagent vial identification: COD B, white label

### REAGENT SETS

HI93754B-25 Reagents for 24 tests

For other accessories see Accessories section.

**Note:** Store the unused vials in their packaging in a cool and dark place.

### MEASUREMENT PROCEDURE



Before using the reagent kit carefully read all the instructions and the Safety Data Sheets (SDS). Pay particular attention to all warnings, cautions and notes. Failure to do so may result in serious injury to the operator.

**Reagent Blank Correction:** This method requires a reagent blank correction. A single blank vial may be used more than once. The blank vial is stable for several months at room temperature. For improved accuracy, run a blank for each set of measurements and always use the same lot of reagents for blank and samples.

- Choose a homogeneous sample. Samples containing solids capable of settling need to be homogenized with a blender.
- Preheat the Hanna<sup>®</sup> Reactor HI839800 to 150 °C (302 °F). The optional HI740217 safety shield is strongly recommended. Do not use an oven or microwave; samples may leak and generate a corrosive and possibly explosive atmosphere.
- Remove the cap from two HI93754B-0 COD Medium Range Reagent Vials.



- Add 2 mL of deionized water to the first vial (#1) and 2 mL of sample to the second vial (#2), while keeping the vials at a 45-degree angle. Replace the cap and invert several times to mix.

**Warning:** The vials will become hot during mixing, use caution when handling.

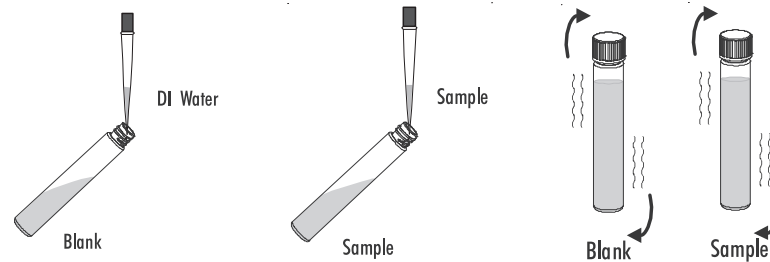

- Insert the vials into the reactor and heat them for 2 hours at 150 °C.
- At the end of the digestion period switch off the reactor. Wait 20 minutes to allow the vials to cool to about 120 °C.
- Invert each vial several times while still warm, then place them in the test tube rack.

**Warning:** The vials are still hot, use caution when handling.

- Leave the vials in the tube rack to cool to room temperature. Do not shake or invert them, the samples may become turbid.
- Select **COD MR EPA (13 mm)** method using the procedure described in the Factory Methods section.
- Insert the 13 mm vial adapter using the procedure described in the Cuvette & Vial Adapters section.
- Insert the blank vial (#1) into the adapter.
- Press **ZERO**. The display will show “-0-” when the meter is zeroed and ready for measurement.

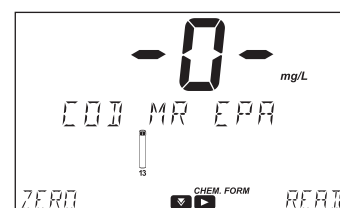
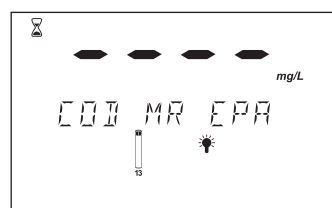
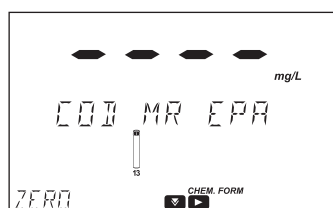
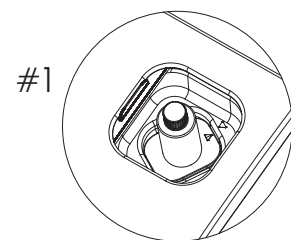
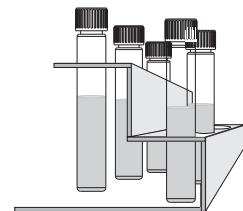
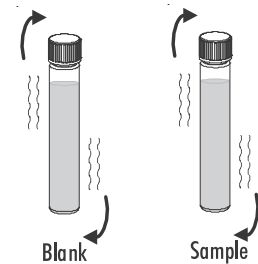

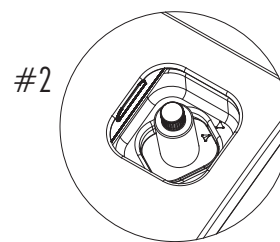

- Remove the vial.
- Insert the sample vial (#2) into the adapter.

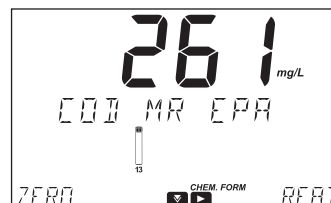
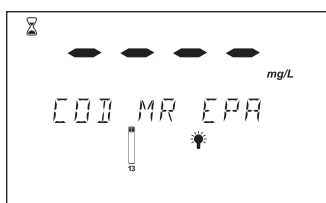
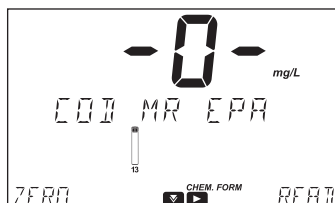

- Press **READ** to start the reading. The instrument displays the results in **mg/L of oxygen (O<sub>2</sub>)**.



- Press the  key to view the wavelength, method ID, date and time.
- Press the  key to view the chemical formula.

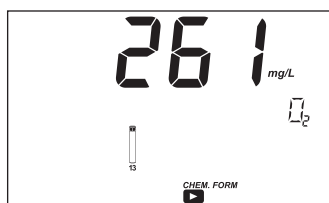

- Press the  key to return to the measurement screen.

### INTERFERENCES

Interference may be caused by:

- Chloride (Cl<sup>-</sup>) above 2000 mg/L. Samples with higher chloride concentration should be diluted

## Chemical Oxygen Demand Medium Range Mercury Free (13 mm Vial)

### SPECIFICATIONS

Range	0 to 1500 mg/L (as O <sub>2</sub> )
Resolution	1 mg/L
Accuracy	±15 mg/L or ±3% of reading at 25 °C, whichever is greater
Wavelength	610 nm
Cuvette type	13 mm diameter
Method	Dichromate Mercury Free
Method ID	#029

### REQUIRED REAGENTS

Code	Description	Quantity
HI93754E-0*	COD Medium Range Reagent Vial	2 vials
DEIONIZED120	Deionized Water	2 mL

\*Reagent vial identification: COD E, white label

### REAGENT SETS

HI93754E-25 Reagents for 24 tests

For other accessories see Accessories section.

**Note:** Store the unused vials in their packaging in a cool and dark place.

### MEASUREMENT PROCEDURE



Before using the reagent kit carefully read all the instructions and the Safety Data Sheets (SDS). Pay particular attention to all warnings, cautions and notes. Failure to do so may result in serious injury to the operator.

**Reagent Blank Correction:** This method requires a reagent blank correction. A single blank vial may be used more than once. The blank vial is stable for several months at room temperature. For improved accuracy, run a blank for each set of measurements and always use the same lot of reagents for blank and samples.

- Choose a homogeneous sample. Samples containing solids capable of settling need to be homogenized with a blender.
- Preheat the Hanna<sup>®</sup> Reactor HI839800 to 150 °C (302 °F). The optional HI740217 safety shield is strongly recommended. Do not use an oven or microwave; samples may leak and generate a corrosive and possibly explosive atmosphere.
- Remove the cap from two HI93754E-0 COD Medium Range Reagent Vials.



- Add 2 mL of deionized water to the first vial (#1) and 2 mL of sample to the second vial (#2), while keeping the vials at a 45-degree angle. Replace the cap and invert several times to mix.

**Warning:** The vials will become hot during mixing, use caution when handling.

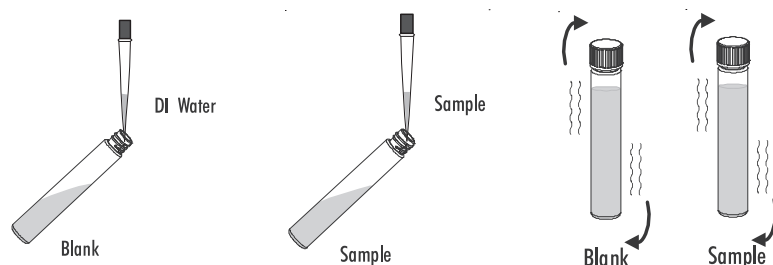

- Insert the vials into the reactor and heat them for 2 hours at 150 °C.
- At the end of the digestion period switch off the reactor. Wait 20 minutes to allow the vials to cool to about 120 °C.
- Invert each vial several times while still warm, then place them in the test tube rack.

**Warning:** The vials are still hot, use caution when handling.

- Leave the vials in the tube rack to cool to room temperature. Do not shake or invert them, the samples may become turbid.
- Select **COD MR Hg Free (13 mm)** method using the procedure described in the Factory Methods section.
- Insert the 13 mm vial adapter using the procedure described in the Cuvette & Vial Adapters section.
- Insert the blank vial (#1) into the adapter.

- Press **ZERO**. The display will show “-0-” when the meter is zeroed and ready for measurement.

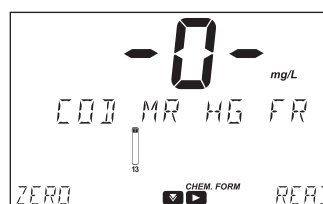
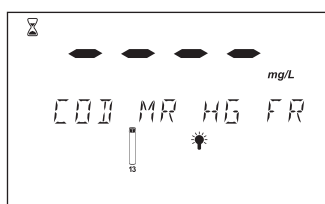
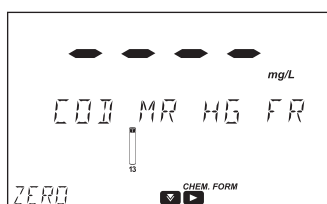
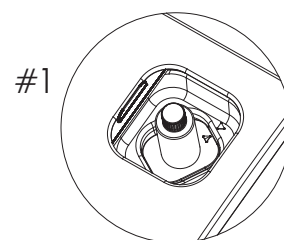
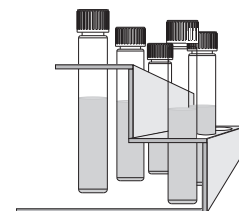
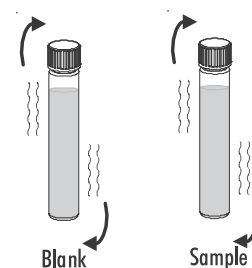

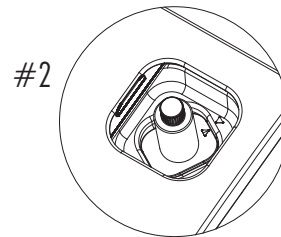

- Remove the vial.
- Insert the sample vial (#2) into the adapter.

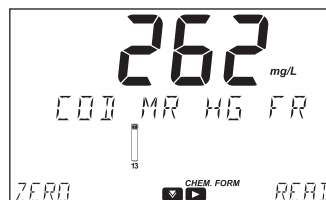
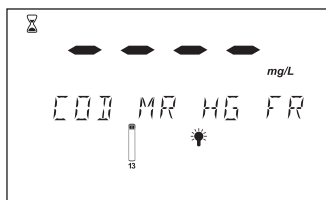
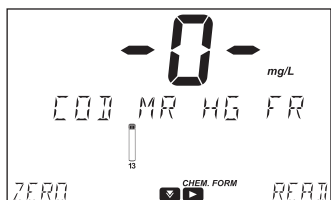

- Press **READ** to start the reading. The instrument displays the results in **mg/L of oxygen (O<sub>2</sub>)**.



- Press the  key to view the wavelength, method ID, date and time.
- Press the  key to view the chemical formula.

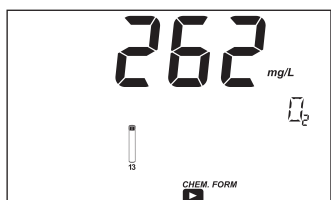

- Press the  key to return to the measurement screen.

### INTERFERENCES

Interference may be caused by:

- Chloride (Cl<sup>-</sup>) above 2000 mg/L. Samples with higher chloride concentration should be diluted



## Chemical Oxygen Demand Medium Range ISO (13 mm Vial)

### SPECIFICATIONS

Range	0 to 1000 mg/L (as O <sub>2</sub> )
Resolution	1 mg/L
Accuracy	±15 mg/L or ±3% of reading at 25 °C, whichever is greater
Wavelength	610 nm
Cuvette type	13 mm diameter
Method	Dichromate ISO
Method ID	#030

### REQUIRED REAGENTS

Code	Description	Quantity
HI93754G-0*	COD Medium Range Reagent Vial	2 vials
DEIONIZED120	Deionized Water	2 mL

\*Reagent vial identification: COD G, white label

### REAGENT SETS

HI93754G-25 Reagents for 24 tests

For other accessories see Accessories section.

**Note:** Store the unused vials in their packaging in a cool and dark place.

### MEASUREMENT PROCEDURE



Before using the reagent kit carefully read all the instructions and the Safety Data Sheets (SDS). Pay particular attention to all warnings, cautions and notes. Failure to do so may result in serious injury to the operator.

**Reagent Blank Correction:** This method requires a reagent blank correction. A single blank vial may be used more than once. The blank vial is stable for several months at room temperature. For improved accuracy, run a blank for each set of measurements and always use the same lot of reagents for blank and samples.

- Choose a homogeneous sample. Samples containing solids capable of settling need to be homogenized with a blender.
- Preheat the Hanna<sup>®</sup> Reactor HI839800 to 150 °C (302 °F). The optional HI740217 safety shield is strongly recommended. Do not use an oven or microwave; samples may leak and generate a corrosive and possibly explosive atmosphere.
- Remove the cap from two HI93754G-0 COD Medium Range Reagent Vials.



- Add 2 mL of deionized water to the first vial (#1) and 2 mL of sample to the second vial (#2), while keeping the vials at a 45-degree angle. Replace the cap and invert several times to mix.

**Warning:** The vials will become hot during mixing, use caution when handling.

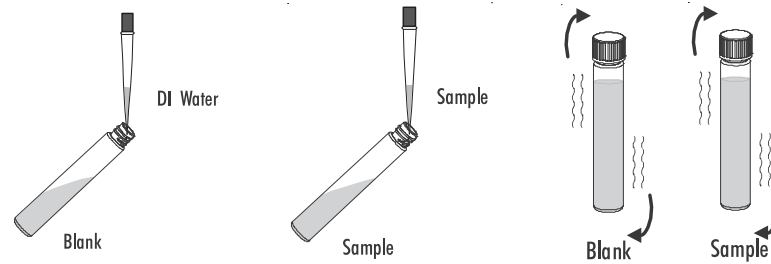

- Insert the vials into the reactor and heat them for 2 hours at 150 °C.
- At the end of the digestion period switch off the reactor. Wait 20 minutes to allow the vials to cool to about 120 °C.
- Invert each vial several times while still warm, then place them in the test tube rack.

**Warning:** The vials are still hot, use caution when handling.

- Leave the vials in the tube rack to cool to room temperature. Do not shake or invert them, the samples may become turbid.
- Select **COD MR ISO (13 mm)** method using the procedure described in the Factory Methods section.
- Insert the 13 mm vial adapter using the procedure described in the Cuvette & Vial Adapters section.
- Insert the blank vial (#1) into the adapter.

- Press **ZERO**. The display will show “-0-” when the meter is zeroed and ready for measurement.

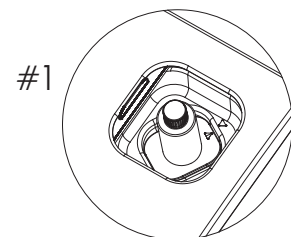
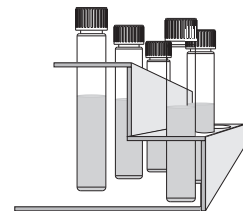
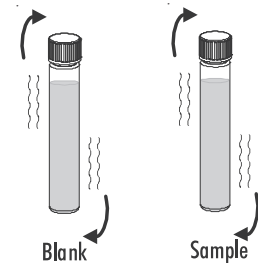
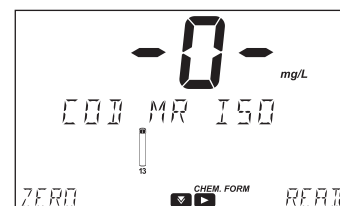
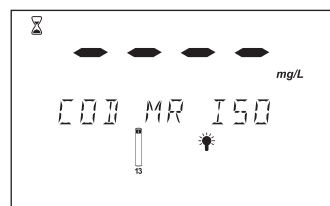
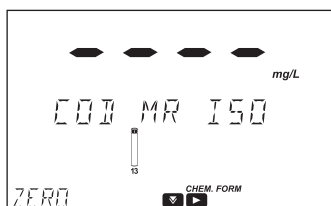

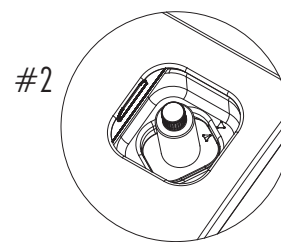

- Remove the vial.
- Insert the sample vial (#2) into the adapter.

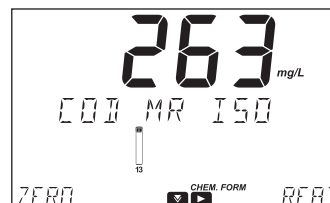
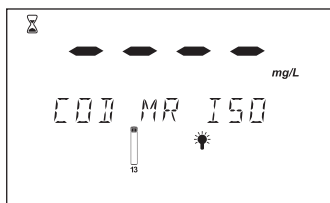
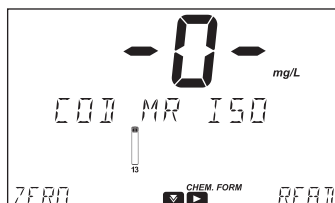

- Press **READ** to start the reading. The instrument displays the results in **mg/L** of oxygen ( $O_2$ ).



- Press the  key to view the wavelength, method ID, date and time.
- Press the  key to view the chemical formula.

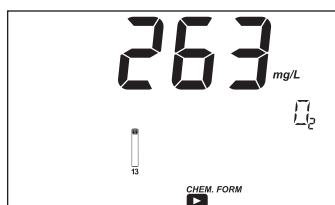

- Press the  key to return to the measurement screen.

## INTERFERENCES

Interference may be caused by:

- Chloride ( $Cl^-$ ) above 2000 mg/L. Samples with higher chloride concentration should be diluted

## Chemical Oxygen Demand High Range EPA (13 mm Vial)

### SPECIFICATIONS

Range	0 to 15000 mg/L (as O <sub>2</sub> )
Resolution	1 mg/L
Accuracy	±150 mg/L or ±2% of reading at 25 °C, whichever is greater
Wavelength	610 nm
Cuvette type	13 mm diameter
Method	Adaptation of the EPA 410.4 Approved Method for the COD Determination on Surface Waters and Wastewaters
Method ID	#031

### REQUIRED REAGENTS

Code	Description	Quantity
HI93754C-0*	COD High Range Reagent Vial	2 vials
DEIONIZED120	Deionized Water	0.2 mL

\*Reagent vial identification: COD C, green label

### REAGENT SETS

HI93754C-25 Reagents for 24 tests

For other accessories see Accessories section.

**Note:** Store the unused vials in their packaging in a cool and dark place.

### MEASUREMENT PROCEDURE



Before using the reagent kit carefully read all the instructions and the Safety Data Sheets (SDS). Pay particular attention to all warnings, cautions and notes. Failure to do so may result in serious injury to the operator.

**Reagent Blank Correction:** This method requires a reagent blank correction. A single blank vial may be used more than once. The blank vial is stable for several months at room temperature. For improved accuracy, run a blank for each set of measurements and always use the same lot of reagents for blank and samples.

- Choose a homogeneous sample. Samples containing solids capable of settling need to be homogenized with a blender.
- Preheat the Hanna<sup>®</sup> Reactor HI839800 to 150 °C (302 °F). The optional HI740217 safety shield is strongly recommended. Do not use an oven or microwave; samples may leak and generate a corrosive and possibly explosive atmosphere.
- Remove the cap from two HI93754C-0 COD High Range Reagent Vials.



- Add 0.2 mL of deionized water to the first vial (#1) and 0.2 mL of sample to the second vial (#2), while keeping the vials at a 45-degree angle. Replace the cap and invert several times to mix.

**Warning:** The vials will become hot during mixing, use caution when handling.

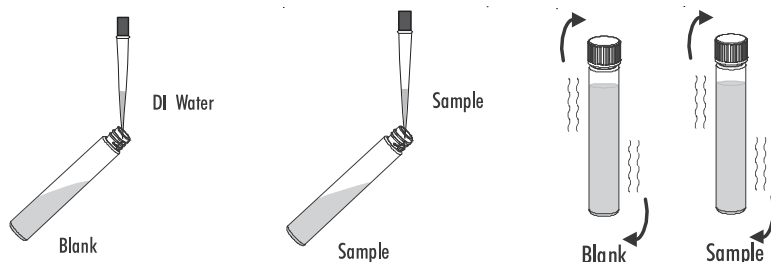

- Insert the vials into the reactor and heat them for 2 hours at 150 °C.
- At the end of the digestion period switch off the reactor. Wait 20 minutes to allow the vials to cool to about 120 °C.
- Invert each vial several times while still warm, then place them in the test tube rack.

**Warning:** The vials are still hot, use caution when handling.

- Leave the vials in the tube rack to cool to room temperature. Do not shake or invert them, the samples may become turbid.
- Select **COD HR EPA (13 mm)** method using the procedure described in the Factory Methods section.
- Insert the 13 mm vial adapter using the procedure described in the Cuvette & Vial Adapters section.
- Insert the blank vial (#1) into the adapter.

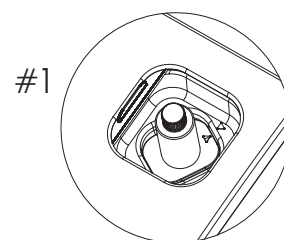
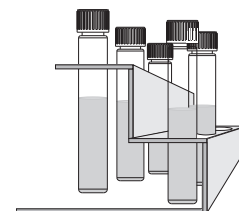
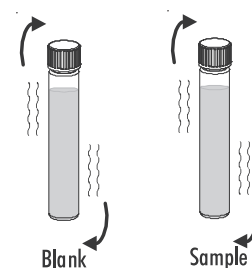

- Press **ZERO**. The display will show “-0-” when the meter is zeroed and ready for measurement.

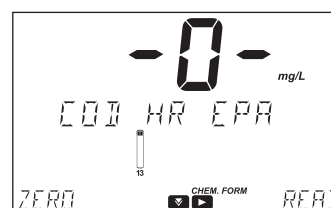
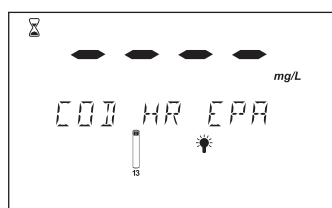
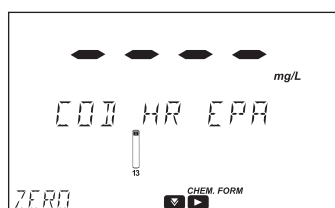

- Remove the vial.
- Insert the sample vial (#2) into the adapter.

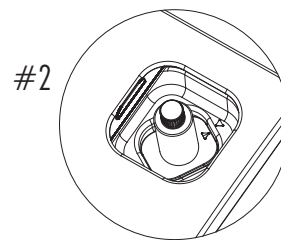

- Press **READ** to start the reading. The instrument displays the results in mg/L of oxygen ( $O_2$ ).

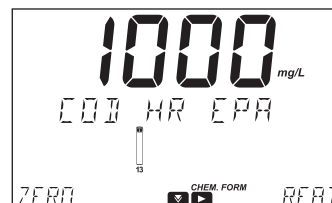
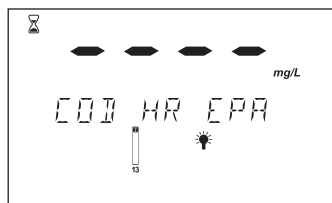
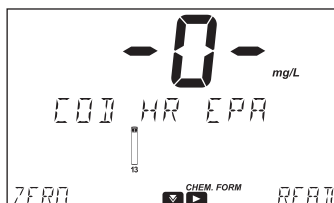

- Press the key to view the wavelength, method ID, date and time.
- Press the key to view the chemical formula.

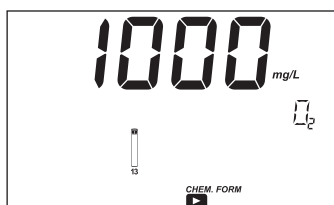

- Press the key to return to the measurement screen.

### INTERFERENCES

Interference may be caused by:

- Chloride ( $Cl^-$ ) above 20000 mg/L. Samples with higher chloride concentration should be diluted

## Chemical Oxygen Demand Ultra High Range (13 mm Vial)

### SPECIFICATIONS

Range	0.0 to 60.0 ppt (as O <sub>2</sub> )
Resolution	0.1 ppt
Accuracy	±0.5 ppt ±3% of reading @ 25°C
Wavelength	610 nm
Cuvette type	13 mm diameter
Method	Adaptation of the EPA 410.4 Approved Method for the COD Determination on Surface Waters and Wastewaters
Method ID	#088

### REQUIRED REAGENT

Code	Description	Quantity
HI93754J-0*	COD Ultra High Range Reagent Vial	2 vials
DEIONIZED120	Deionized Water	0.1 mL

\*Reagent vial identification: COD J, blue label

### REAGENT SETS

HI93754J-25 Reagents for 24 tests

For other accessories see Accessories section.

**Note:** Store the unused vials in their packaging in a cool and dark place.

### MEASUREMENT PROCEDURE



Before using the reagent kit carefully read all the instructions and the Safety Data Sheets (SDS). Pay particular attention to all warnings, cautions and notes. Failure to do so may result in serious injury to the operator.

**Reagent Blank Correction:** This method requires a reagent blank correction. A single blank vial may be used more than once. The blank vial is stable for several months at room temperature. For improved accuracy, run a blank for each set of measurements and always use the same lot of reagents for blank and samples.

- Choose a homogeneous sample. Samples containing solids capable of settling need to be homogenized with a blender.
- Preheat the Hanna<sup>®</sup> Reactor HI839800 to 150 °C (302 °F). The optional HI740217 safety shield is strongly recommended. Do not use an oven or microwave; samples may leak and generate a corrosive and possibly explosive atmosphere.
- Remove the cap from two HI93754J-0 COD Ultra High Range Reagent Vials.



- Add 0.1 mL of deionized water to the first vial (#1) and 0.1 mL of sample to the second vial (#2), while keeping the vials at a 45-degree angle. Replace the cap and invert several times to mix.

**Warning:** The vials will become hot during mixing, use caution when handling.

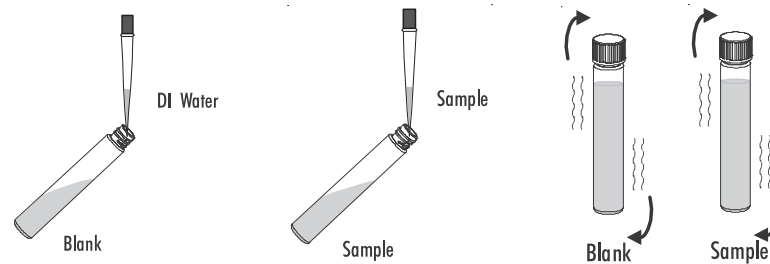

- Insert the vials into the reactor and heat them for 2 hours at 150 °C.
- At the end of the digestion period switch off the reactor. Wait 20 minutes to allow the vials to cool to about 120 °C.
- Invert each vial several times while still warm, then place them in the test tube rack.

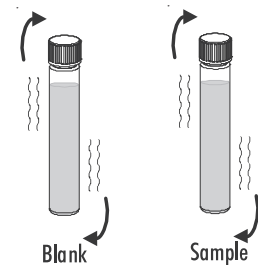

**Warning:** The vials are still hot, use caution when handling.

- Leave the vials in the tube rack to cool to room temperature. Do not shake or invert them, the samples may become turbid.
- Select **COD UHR (13 mm)** method using the procedure described in the Factory Methods section.
- Insert the 13 mm vial adapter using the procedure described in the Cuvette & Vial Adapters section.
- Insert the blank vial (#1) into the adapter.

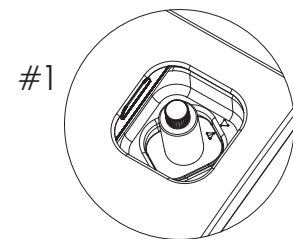
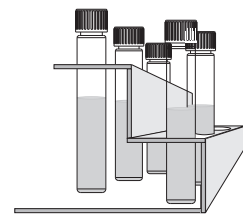

- Press **ZERO**. The display will show “-0-” when the meter is zeroed and ready for measurement.

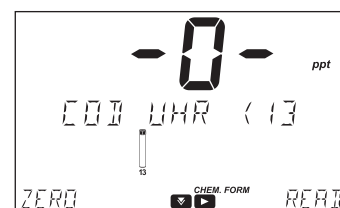
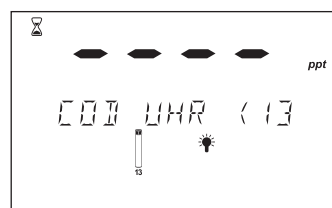
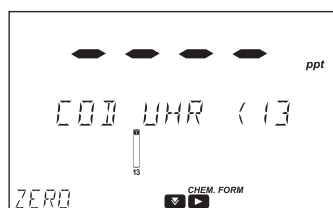



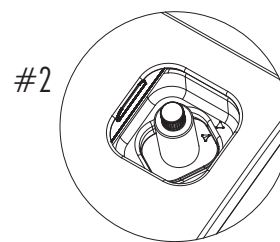

- Remove the vial.
- Insert the sample vial (#2) into the adapter.

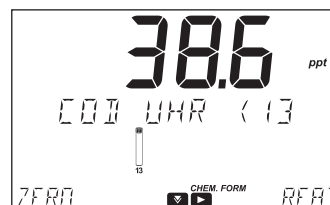
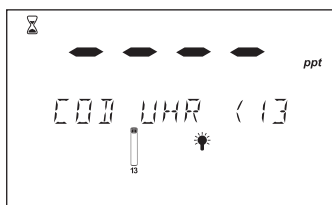
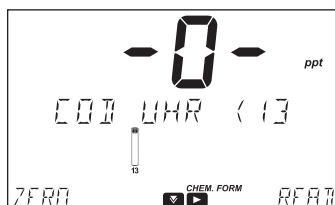

- Press **READ** to start the reading. The instrument displays the results in mg/L of oxygen ( $O_2$ ).



- Press the  key to view the wavelength, method ID, date and time.
- Press the  key to view the chemical formula.

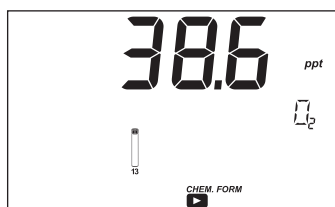

- Press the  key to return to the measurement screen.

## INTERFERENCES

Interference may be caused by:

- Chloride ( $Cl^-$ ) above 20000 mg/L. Samples with higher chloride concentration should be diluted

## Color of Water

### SPECIFICATIONS

Range	0 to 500 PCU (Platinum Cobalt Units)
Resolution	1 PCU
Accuracy	$\pm 10$ PCU $\pm 5\%$ of reading at 25 °C
Wavelength	460 nm
Cuvette type	22 mm diameter
Method	Adaptation of the Standard Methods for the Examination of Water and Wastewater, 18 <sup>th</sup> Edition, Colorimetric Platinum Cobalt Method
Method ID	#032

### REQUIRED ACCESSORIES

0.45  $\mu$ m membrane for true color measurement  
For other accessories see Accessories section.

### MEASUREMENT PROCEDURE

- Select the **Color of Water** method using the procedure described in the Factory Methods section.

- Fill the first cuvette (#1) with 10 mL of deionized water (up to the mark). Replace the plastic stopper and the cap.

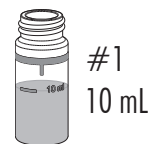

- Insert the blank cuvette (#1) into the holder and close the lid.

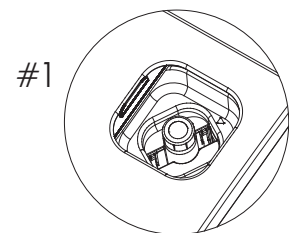

- Press **ZERO**. The display will show “-0-” when the meter is zeroed and ready for measurement.

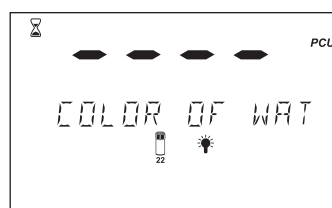
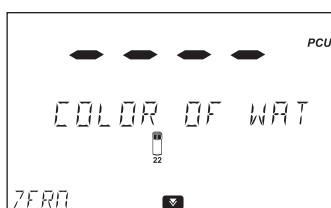

- Remove the cuvette.
- Fill the second cuvette (#2) with 10 mL of unfiltered sample (up to the mark). Replace the plastic stopper and the cap. This is the apparent color.



- Filter 10 mL of sample through a filter with a  $0.45\ \mu\text{m}$  membrane into the third cuvette (#3), up to the 10 mL mark. Replace the plastic stopper and the cap. This is the true color.

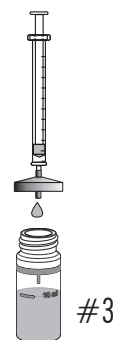

- Insert the apparent color cuvette (#2) into the instrument and close the lid.

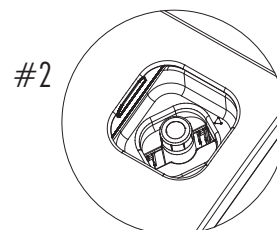

- Press **READ** to start the reading. The instrument displays the results in **Platinum Cobalt Units (PCU)**.

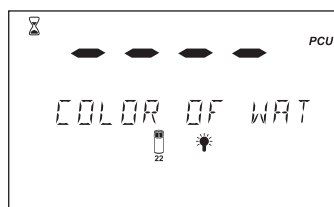
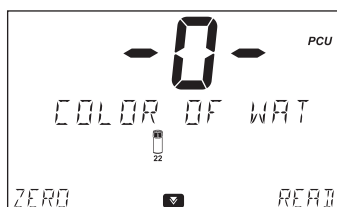

- Remove the apparent color cuvette (#2) from the holder, insert the true color cuvette (#3) into the holder and close the lid.

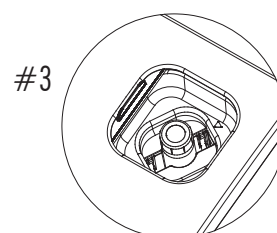

- Press **READ** to start the reading. The instrument displays the results in **Platinum Cobalt Units (PCU)**.

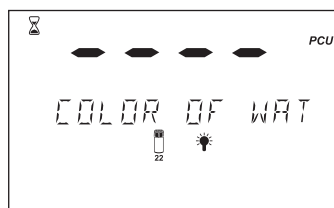
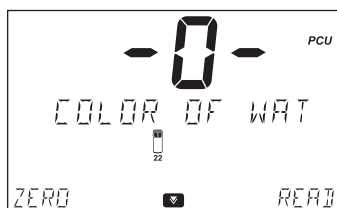

- Press the  key to view the wavelength, method ID, date and time.

## Copper Low Range

### SPECIFICATIONS

Range	0 to 1500 $\mu\text{g/L}$ (as Cu)
Resolution	1 $\mu\text{g/L}$
Accuracy	$\pm 10 \mu\text{g/L} \pm 5\%$ of reading at 25 °C
Wavelength	575 nm
Cuvette type	22 mm diameter
Method	Adaptation of the EPA Method
Method ID	#033

### REQUIRED REAGENTS

Code	Description	Quantity
HI95747-0	Copper Low Range Reagent	1 packet

### REAGENT SETS

HI95747-01 Reagents for 100 tests

HI95747-03 Reagents for 300 tests

For other accessories see Accessories section.

### MEASUREMENT PROCEDURE

- Select the **Copper LR** method using the procedure described in the Factory Methods section.

- Fill the cuvette with 10 mL of unreacted sample (up to the mark). Replace the plastic stopper and the cap.

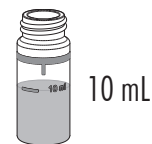

10 mL

- Insert the cuvette into the holder and close the lid.

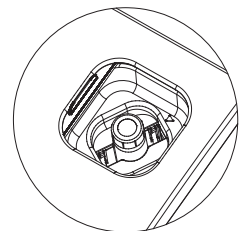

- Press **ZERO**. The display will show “-0-” when the meter is zeroed and ready for measurement.

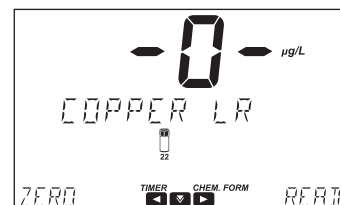
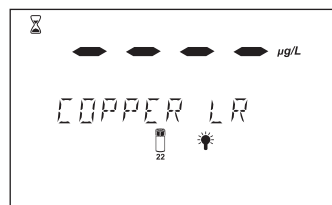
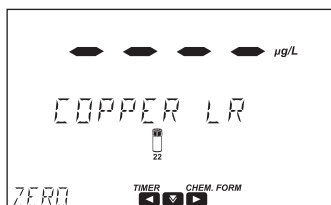

- Remove the cuvette.

- Add one packet of **HI95747-0** Copper Low Range Reagent. Replace the plastic stopper and the cap. Shake gently for about 15 seconds.

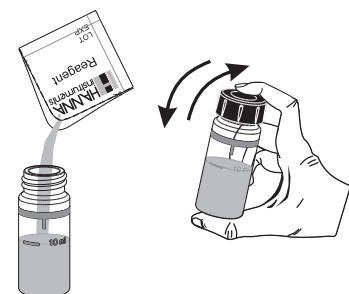

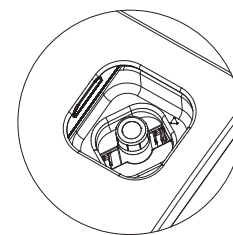

- Insert the cuvette into the holder and close the lid.
- Press the ◀ key to access the timer menu. Press **START** to start Timer 1, the display will show the countdown prior to measurement or wait 45 seconds.
- Press **READ** to start the reading. The instrument displays the results in  $\mu\text{g/L}$  of copper (Cu).

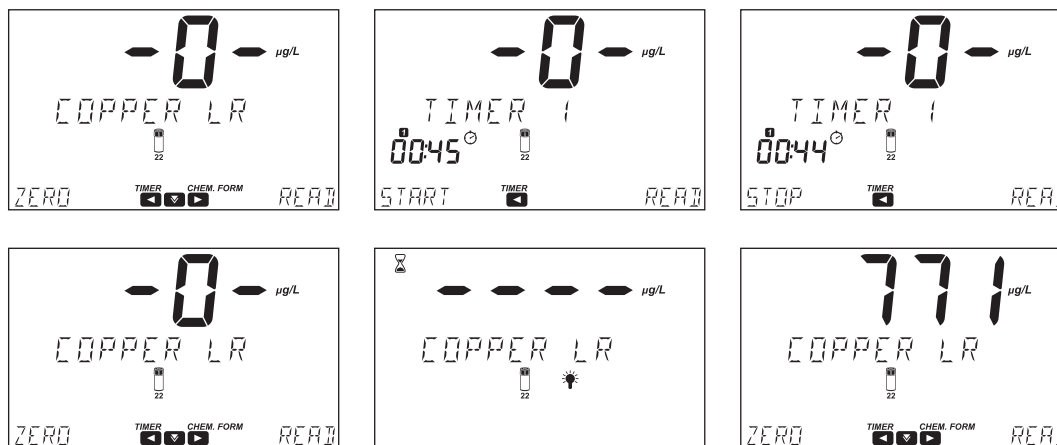

- Press the ▼ key to view the wavelength, method ID, date and time.
- Press the ▶ key to view the chemical formula.

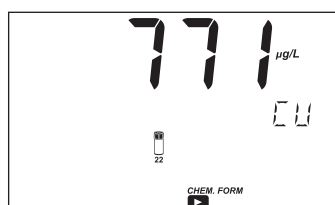

- Press the ▶ key to return to the measurement screen.

## INTERFERENCES

Interference may be caused by:

- Cyanide, Silver
- For samples overcoming buffering capacity of reagent around pH 6.8, pH should be adjusted between 6 and 8

## Copper High Range

### SPECIFICATIONS

Range	0.00 to 5.00 mg/L (as Cu)
Resolution	0.01 mg/L
Accuracy	$\pm 0.02$ mg/L $\pm 4\%$ of reading at 25 °C
Wavelength	560 nm
Cuvette type	22 mm diameter
Method	Adaptation of the EPA Method
Method ID	#034

### REQUIRED REAGENTS

Code	Description	Quantity
HI93702-0	Copper High Range Reagent	1 packet

### REAGENT SETS

HI93702-01 Reagents for 100 tests

HI93702-03 Reagents for 300 tests

For other accessories see Accessories section.

### MEASUREMENT PROCEDURE

- Select the **Copper HR** method using the procedure described in the Factory Methods section.

- Fill the cuvette with 10 mL of unreacted sample (up to the mark). Replace the plastic stopper and the cap.

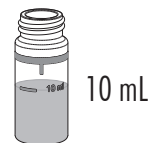

- Insert the cuvette into the holder and close the lid.

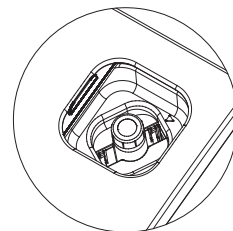

- Press **ZERO**. The display will show “-0-” when the meter is zeroed and ready for measurement.

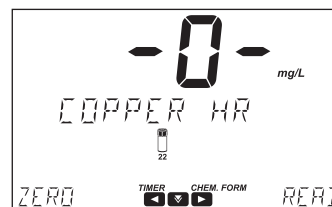
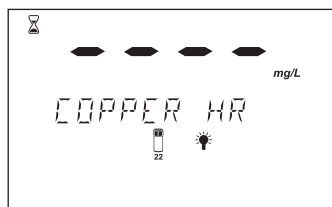
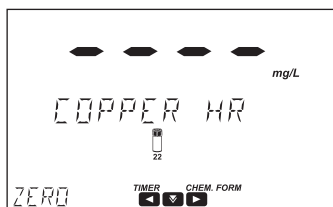

- Remove the cuvette.

- Add one packet of **HI93702-0** Copper High Range Reagent. Replace the plastic stopper and the cap. Shake gently for about 15 seconds.

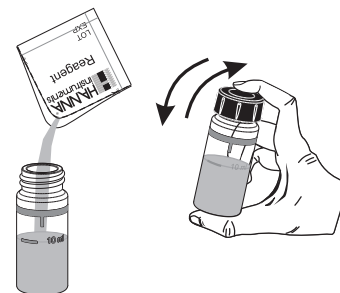

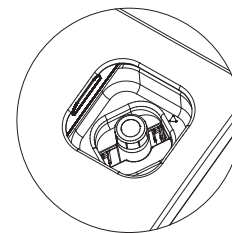

- Insert the cuvette into the holder and close the lid.
- Press the ◀ key to access the timer menu. Press **START** to start Timer 1, the display will show the countdown prior to measurement or wait 45 seconds.
- Press **READ** to start the reading. The instrument displays the results in mg/L of copper (Cu).

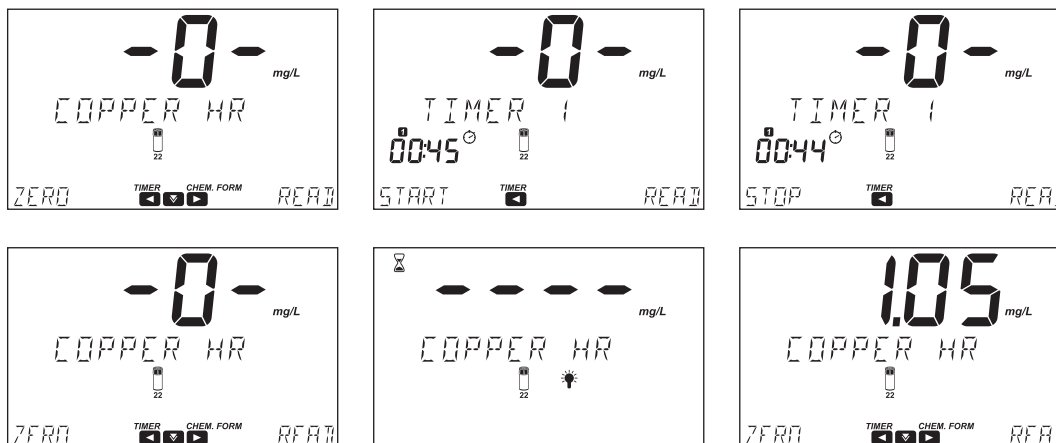

- Press the ▼ key to view the wavelength, method ID, date and time.
- Press the ► key to view the chemical formula.

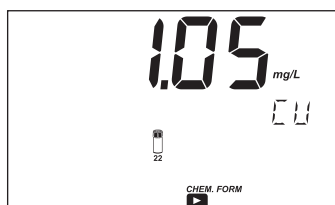

- Press the ► key to return to the measurement screen.

## INTERFERENCES

Interference may be caused by:

- Cyanide, Silver
- For samples overcoming buffering capacity of reagent around pH 6.8, pH should be adjusted between 6 and 8

## Cyanide

### SPECIFICATIONS

Range	0.000 to 0.200 mg/L (as CN <sup>-</sup> )
Resolution	0.001 mg/L
Accuracy	±0.005 mg/L ±3% of reading at 25 °C
Wavelength	610 nm
Cuvette type	22 mm diameter
Method	Pyridine-Pyrazalone
Method ID	#035

### REQUIRED REAGENTS

Code	Description	Quantity
HI93714A-0	Cyanide Reagent A	1 spoon
HI93714B-0	Cyanide Reagent B	1 packet
HI93714C-0	Cyanide Reagent C	1 packet

### REAGENT SETS

HI93714-01	Reagents for 100 tests
HI93714-03	Reagents for 300 tests

For other accessories see Accessories section.

### MEASUREMENT PROCEDURE

- Select the **Cyanide** method using the procedure described in the Factory Methods section.

- Fill the cuvette with 10 mL of unreacted sample (up to the mark). Replace the plastic stopper and the cap.

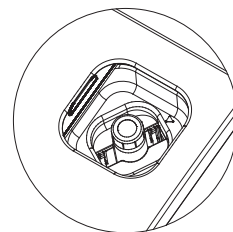

- Insert the cuvette into the holder and close the lid.

- Press **ZERO**. The display will show “-0-” when the meter is zeroed and ready for measurement.

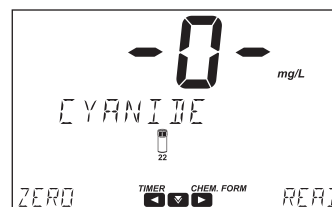
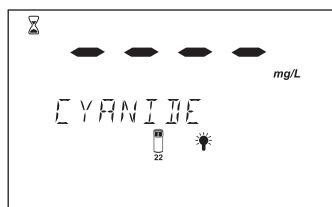
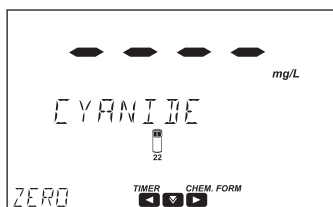

- Remove the cuvette and add 1 level spoon of **HI93714A-0** Cyanide Reagent A. Remember to close the reagent bottle immediately after use.

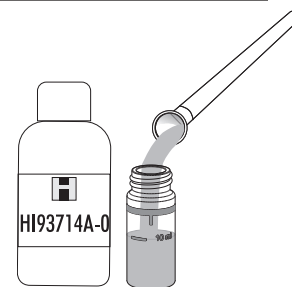



**Note:** Pay attention to the way the spoon is filled: do not press the powder; do not overfill it.

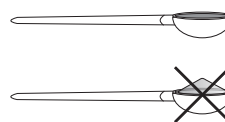

- To prevent the chlorine gas, developed during the reaction, from escaping, replace the plastic stopper and cap immediately. Shake gently for 30 seconds.

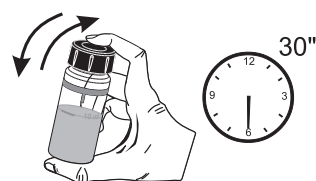

- Wait for 30 seconds leaving the cuvette tightly capped and undisturbed, then add one packet of HI93714B-0 Cyanide Reagent B. Replace the plastic stopper and the cap. Shake gently for 10 seconds.

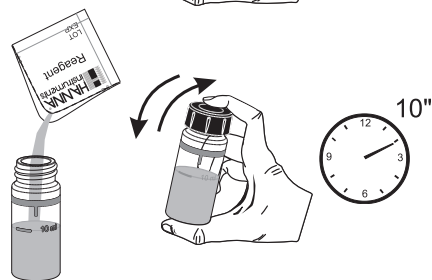

- Add one packet of HI93714C-0 Cyanide Reagent C. Replace the plastic stopper and the cap. Shake vigorously for 20 seconds.

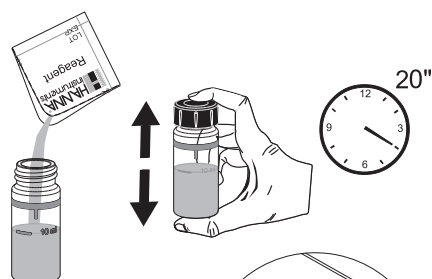

- Insert the cuvette into the holder and close the lid.

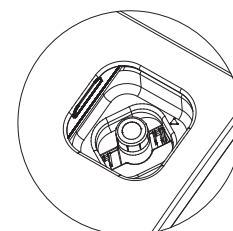



- Press the ◀ key to access the timer menu. Press **START** to start Timer 1, the display will show the countdown prior to measurement or wait 25 minutes.

**Note:** Gently shake the cuvettes 4 or 5 times during the first 20 minutes of the timer. Accuracy is not affected by undissolved reagent powder.

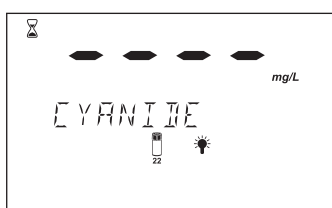
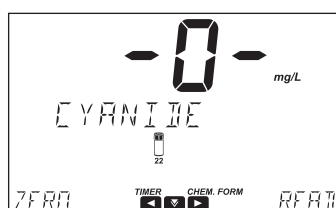
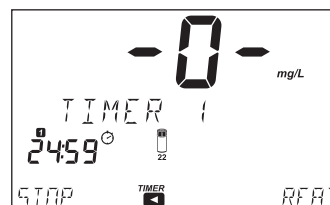
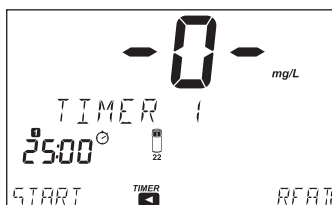
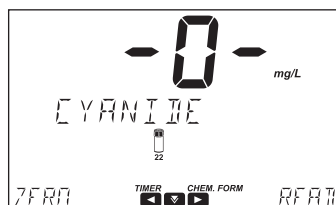
- Press **READ** to start the reading. The instrument displays the results in mg/L of cyanide (CN).



- Press the  key to view the wavelength, method ID, date and time.
- Press the  key to view the chemical formula.
- Press the  key to convert the results to mg/L of potassium cyanide (KCN).

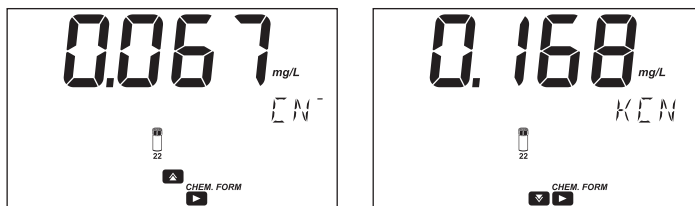

- Press the  key to return to the measurement screen.

**Note:** For the most accurate results perform the test between 20 and 25 °C.

### INTERFERENCES

Interference may be caused by:

- Large amounts of turbidity that will cause high readings
- Oxidizing (such as chlorine) or reducing agents (such as sulfide or sulfur dioxide) are known to interfere with the measurement. Distillation will remove these.
- Samples with high pH values should be adjusted to approximately pH 7 before testing.

**CAUTION:** Cyanides, their solutions, and hydrogen cyanide liberated by acids, are very poisonous.

## Cyanuric Acid

### SPECIFICATIONS

Range	0 to 100 mg/L (as CYA)
Resolution	1 mg/L
Accuracy	$\pm 1$ mg/L $\pm 15\%$ of reading at 25 °C
Wavelength	525 nm
Cuvette type	22 mm diameter
Method	Adaptation of the Turbidimetric Method
Method ID	#036

### REQUIRED REAGENTS

Code	Description	Quantity
HI93722-0	Cyanuric Acid Reagent	1 packet

### REAGENT SETS

HI93722-01 Reagents for 100 tests

HI93722-03 Reagents for 300 tests

For other accessories see Accessories section.

### MEASUREMENT PROCEDURE

- Select the **Cyanuric Acid** method using the procedure described in the Factory Methods section.

- Fill the first cuvette (#1) with 10 mL of unreacted sample (up to the mark). Replace the plastic stopper and the cap.

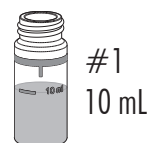

- Insert the cuvette into the holder and close the lid.

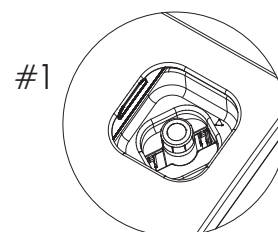

- Press **ZERO**. The display will show “-0-” when the meter is zeroed and ready for measurement.

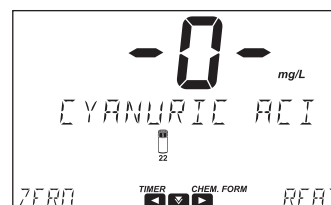
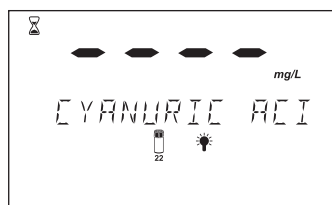
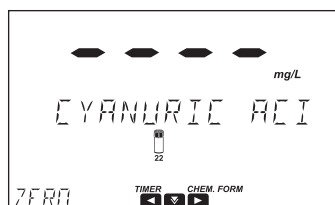

- Fill a beaker with 25 mL sample (up to the mark).



- Add packet of HI93722-0 Cyanuric Acid Reagent and mix to dissolve.



- Fill a second (#2) cuvette with 10 mL of the reacted sample (up to the mark). Replace the plastic stopper and the cap.

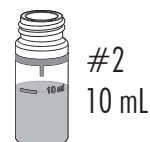

- Insert the cuvette into the holder and close the lid.

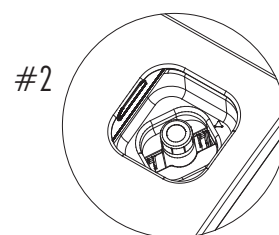

- Press the ◀ key to access the timer menu. Press **START** to start Timer 1, the display will show the countdown prior to measurement or wait 45 seconds.
- Press **READ** to start the reading. The instrument displays the results in **mg/L of cyanuric acid**.

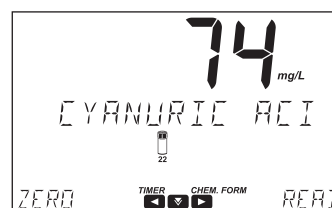
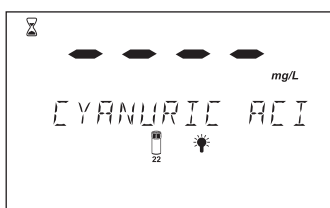
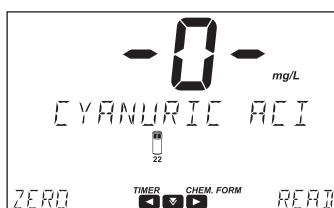
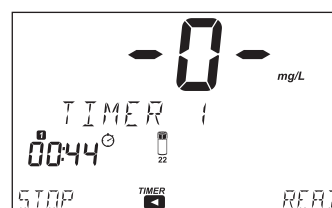
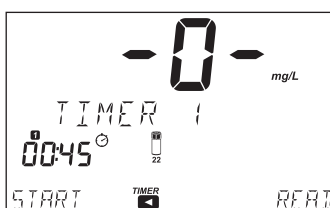
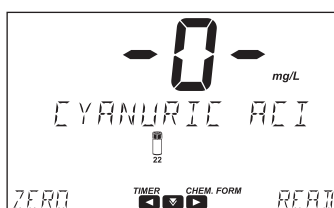

- Press the ▼ key to view the wavelength, method ID, date and time.
- Press the ► key to view the chemical formula.

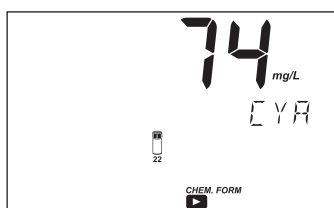

- Press the ► key to return to the measurement screen.

## Fluoride Low Range

### SPECIFICATIONS

Range	0.00 to 2.00 mg/L (as F <sup>-</sup> )
Resolution	0.01 mg/L
Accuracy	±0.03 mg/L ±3% of reading at 25 °C
Wavelength	575 nm
Cuvette type	22 mm diameter
Method	Adaptation of the Standard Methods for the Examination of Water and Wastewater, 18 <sup>th</sup> Edition, SPADNS Method
Method ID	#037

### REQUIRED REAGENTS

Code	Description	Quantity
HI93729-0	Fluoride Low Range Reagent	4 mL

### REAGENT SETS

HI93729-01 Reagents for 100 tests

HI93729-03 Reagents for 300 tests

For other accessories see Accessories section.

### MEASUREMENT PROCEDURE

- Select the **Fluoride LR** method using the procedure described in the Factory Methods section.

- Add 2 mL of HI93729-0 Fluoride Low Range Reagent to two cuvettes.

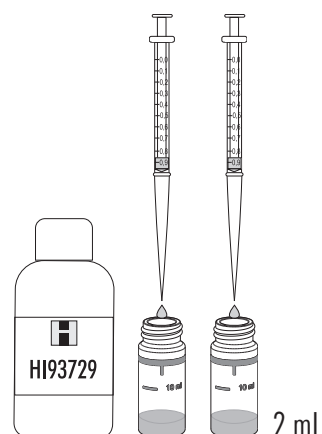

- Use a plastic pipette to fill the first cuvette to the 10 mL mark with deionized water (#1). Replace the plastic stopper and the cap. Invert several times to mix.
- Use a plastic pipette to fill the second cuvette to the 10 mL mark with unreacted sample (#2). Replace the plastic stopper and the cap. Invert several times to mix.

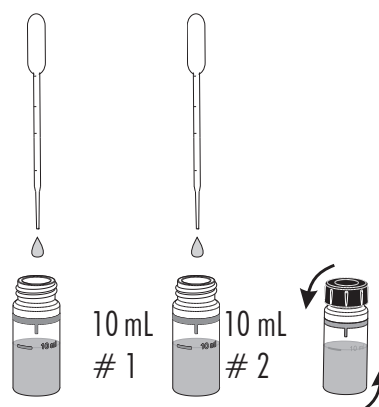

**Note:** For the most accurate results use two graduated pipettes to deliver exactly 8 mL of deionized water and 8 mL of sample.

- Insert the first cuvette (#1) into the holder and close the lid.

#1

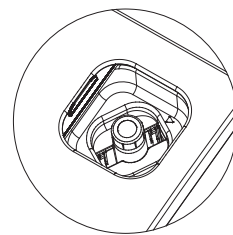

- Press the ◀ key to access the timer menu. Press **START** to start Timer 1, the display will show the countdown prior to zeroing the blank or wait 2 minutes.
- Press **ZERO**. The display will show “-0-” when the meter is zeroed and ready for measurement.

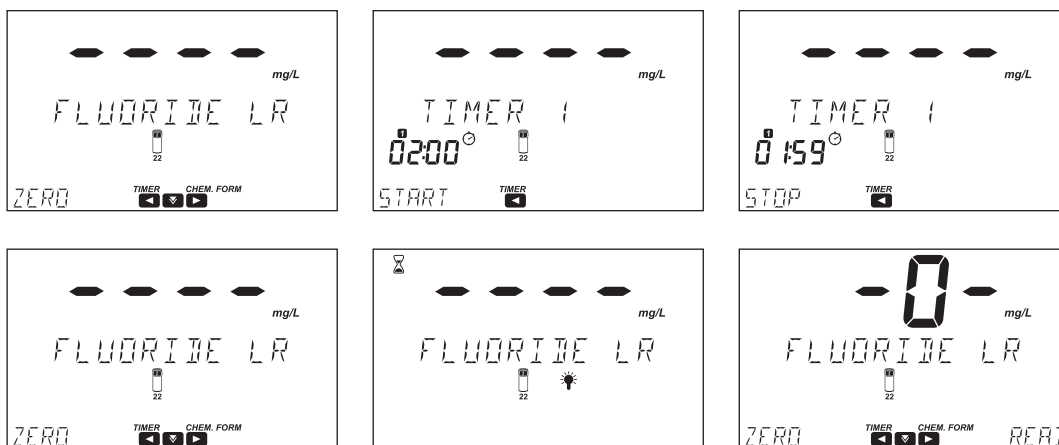

- Remove the cuvette.
- Insert the second cuvette (#2) with the reacted sample into the holder and close the lid.

#2

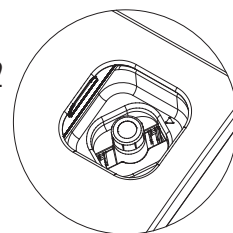

- Press **READ** to start reading. The instrument displays the results in mg/L of fluoride (F).

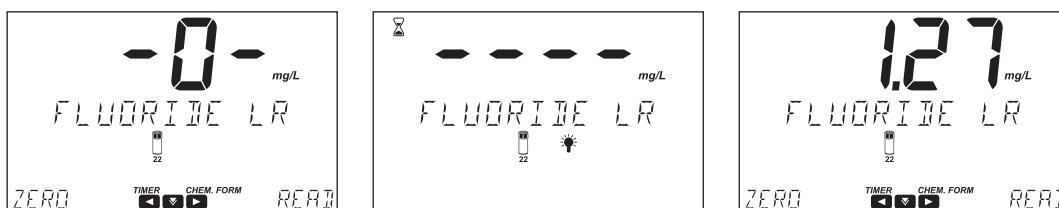

- Press the ▼ key to view the wavelength, method ID, date and time.
- Press the ▶ key to view the chemical formula.

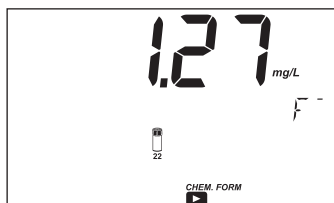

- Press the ▶ key to return to the measurement screen.

**Note:** For wastewater or seawater samples, before performing measurements, distillation is required.

## INTERFERENCES

Interference may be caused by:

- Alkalinity above 5000 mg/L  $\text{CaCO}_3$
- Chloride above 700 mg/L
- Sulfate above 200 mg/L
- Orthophosphate above 16 mg/L
- Iron (Ferric) above 10 mg/L
- Sodium hexametaphosphate above 1.0 mg/L
- Aluminum above 0.1 mg/L
- Highly colored and turbid samples may require distillation
- Highly alkaline samples can be neutralized with nitric acid

## Fluoride High Range

### SPECIFICATIONS

Range	0.0 to 20.0 mg/L (as F <sup>-</sup> )
Resolution	0.1 mg/L
Accuracy	±0.5 mg/L ±3% of reading at 25 °C
Wavelength	575 nm
Cuvette type	22 mm diameter
Method	Adaptation of the Standard Methods for the Examination of Water and Wastewater, 18 <sup>th</sup> Edition, SPADNS Method
Method ID	#038

### REQUIRED REAGENTS

Code	Description	Quantity
HI93739A-0	Fluoride High Range Reagent A	2 mL
HI93739B-0	Fluoride High Range Reagent B	8 mL

### REAGENT SETS

HI93739-01	Reagents for 100 tests
HI93739-03	Reagents for 300 tests

For other accessories see Accessories section.

### MEASUREMENT PROCEDURE

- Select the **Fluoride HR** method using the procedure described in the Factory Methods section.

- Use 1 mL syringe one and add 2 mL of **HI93739A-0** Fluoride High Range Reagent A to the cuvette. Use the plastic pipette to fill up the cuvette to the 10 mL mark with **HI93739B-0** Fluoride High Range Reagent B.

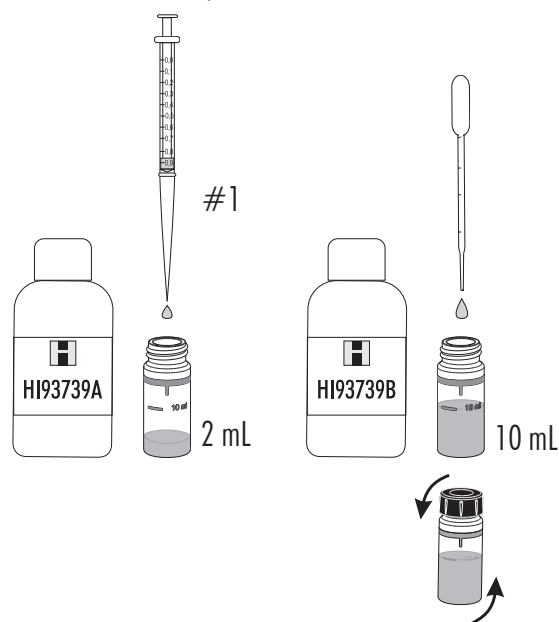

- Replace the plastic stopper and the cap. Invert several times to mix.

- Insert the cuvette into the holder and close the lid.

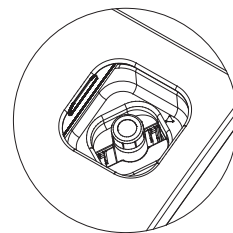



- Press the ◀ key to access the timer menu. Press **START** to start Timer 1, the display will show the countdown prior to zeroing the blank or wait 1 minute.
- Press **ZERO**. The display will show “-0-” when the meter is zeroed and ready for measurement.

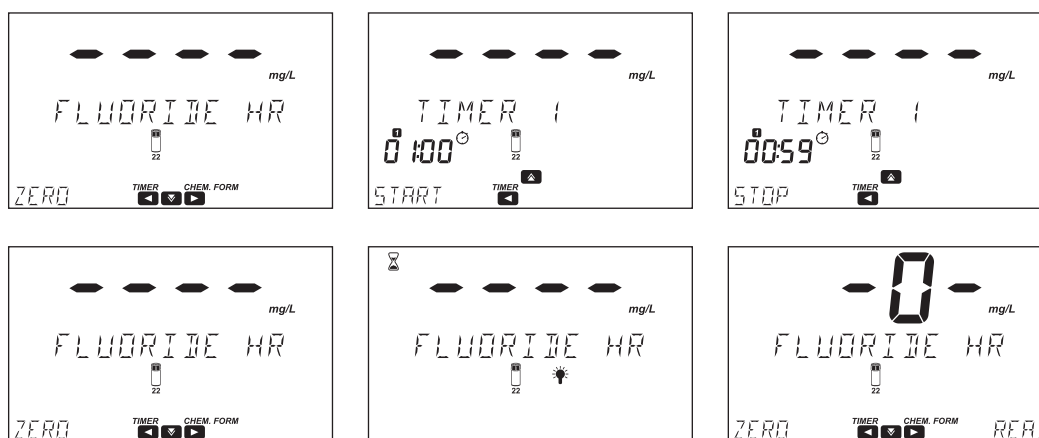

- Remove the cuvette.
- Add 1 mL of sample to the cuvette using the second 1 mL syringe.
- Replace the plastic stopper and the cap. Invert several times to mix.

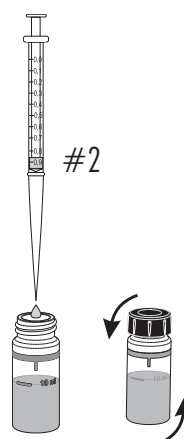

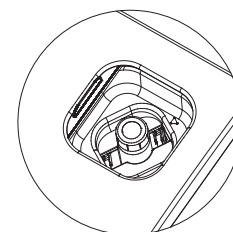

- Insert the cuvette into the holder and close the lid.

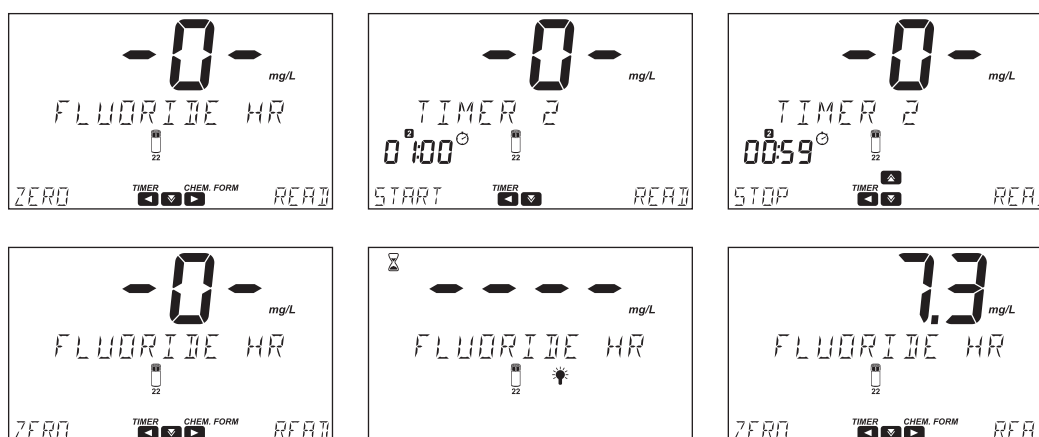

- Press the ◀ key to access the timer menu. Press **START** to start Timer 2, the display will show the countdown prior to measurement or wait 1 minute.
- Press **READ** to start the reading. The instrument displays the results in mg/L of fluoride (F).



- Press the  key to view the wavelength, method ID, date and time.
- Press the  key to view the chemical formula.

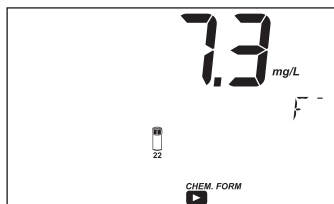

- Press the  key to return to the measurement screen.

**Note:** For wastewater or seawater samples, before performing measurements, distillation is required.

### INTERFERENCES

Interference may be caused by:

- Alkalinity above 5000 mg/L  $\text{CaCO}_3$
- Chloride above 700 mg/L
- Sulfate above 200 mg/L
- Orthophosphate above 16 mg/L
- Aluminum above 0.1 mg/L
- Iron (Ferric) above 10 mg/L
- Sodium hexametaphosphate above 1.0 mg/L
- Highly colored and turbid samples may require distillation
- Highly alkaline samples can be neutralized with nitric acid

## Hardness, Calcium

### SPECIFICATIONS

Range	0.00 to 2.70 mg/L (as CaCO <sub>3</sub> )
Resolution	0.01 mg/L
Accuracy	±0.08 mg/L ±4% of reading at 25 °C
Wavelength	523 nm
Cuvette type	22 mm diameter
Method	Adaptation of the Standard Methods for the Examination of Water and Wastewater, 18 <sup>th</sup> Edition, Calmagite Method
Method ID	#039

### REQUIRED REAGENTS

Code	Description	Quantity
HI93720A-0	Calcium Hardness Reagent A	0.5 mL
HI93720B-0	Calcium Hardness Reagent B	0.5 mL
HI93720C-0	Calcium Hardness Reagent C	1 drop

### REAGENT SETS

HI93720-01	Reagents for 100 tests
HI93720-03	Reagents for 300 tests

For other accessories see Accessories section.

### MEASUREMENT PROCEDURE

- Select the [Hardness \(Calcium\)](#) method using the procedure described in the Factory Methods section.

- Rinse a graduated beaker several times with unreacted sample, before filling it to the 50 mL mark with the sample.

- Add 0.5 mL of [HI93720A-0](#) Calcium Hardness Reagent A. Swirl to mix the solution.

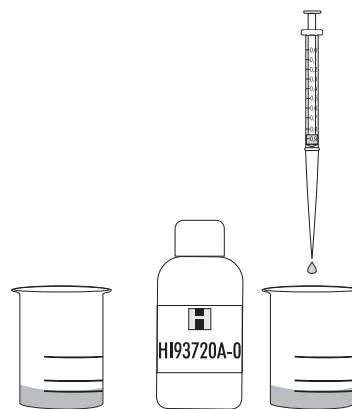

- Add 0.5 mL of [HI93720B-0](#) Calcium Hardness Reagent B. Swirl to mix the solution. Use this solution to rinse 2 cuvettes before filling them up to the 10 mL mark.

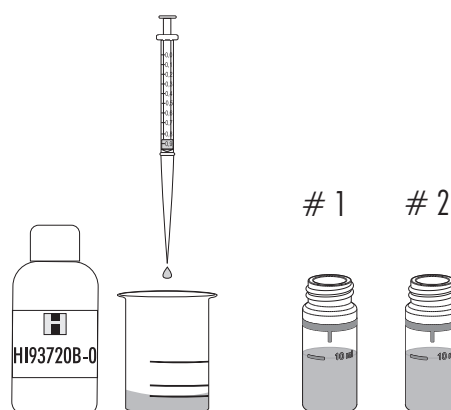

- Add 1 drop of HI93720C-0 Calcium Hardness Reagent C to one cuvette (#1).

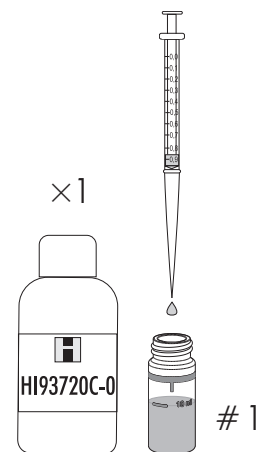

- Replace the plastic stopper and the cap. Invert the cuvette several times to mix. This is the blank.



- Insert the blank cuvette (#1) into the holder and close the lid.

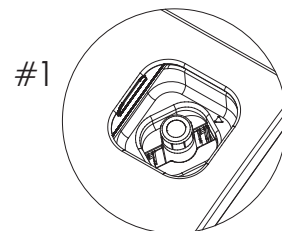

- Press **ZERO**. The display will show “-0-” when the meter is zeroed and ready for measurement.

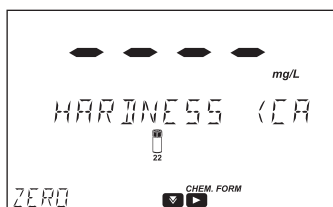

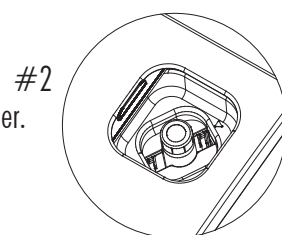

- Remove the blank cuvette (#1) and insert the second cuvette (#2) into the holder.

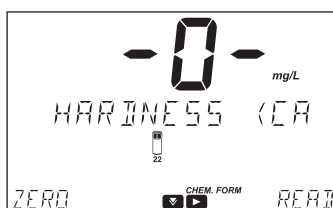

- Press **READ** to start the reading. The instrument displays concentration in **mg/L** of calcium carbonate ( $\text{CaCO}_3$ ).



- Press the  key to view the wavelength, method ID, date and time.
- Press the  key to view the chemical formula.

- Press the ▲ key to convert the results to English (°e), French (°f) or German (°dH) degrees.

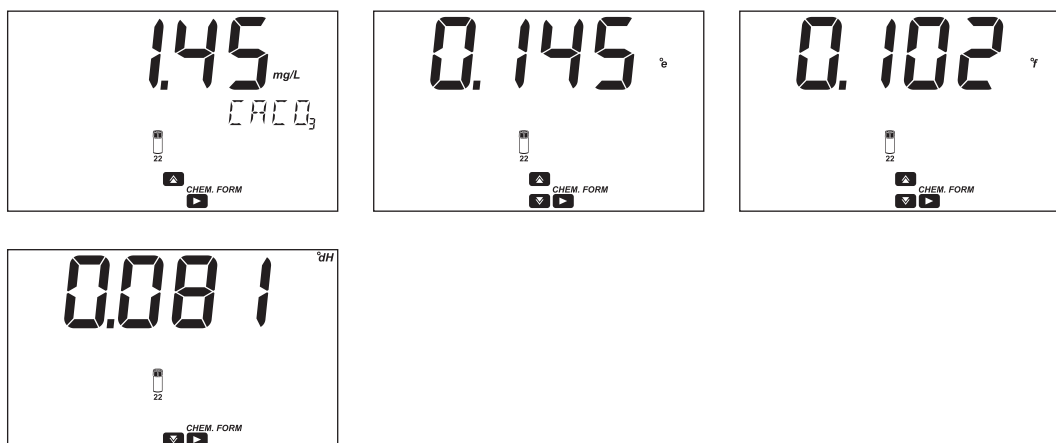

- Press the ► key to return to the measurement screen.

**Note:** This test will detect any calcium contamination in the beaker, measuring syringes or sample cells. To test cleanliness repeat the test multiple times until consistent results are obtained.

### SAMPLE DILUTION

This method is designed to determine low levels of hardness, typically found in water purification systems.

When testing some other sources of water, it is not uncommon to come across levels of hardness that are greater than the range of this method.

This problem can be overcome through dilution. Dilutions must be performed with hardness-free water or the readings will be erroneous.

To reduce the level of hardness by a factor of one hundred:

- Fill a 1 mL syringe with the sample.
- Add 0.5 mL of sample to a clean, dry 50 mL beaker
- Fill the beaker up to the 50 mL mark with hardness-free water.

### INTERFERENCES

Interference may be caused by:

- Excessive amounts of heavy metals

## Hardness, Magnesium

### SPECIFICATIONS

Range	0.00 to 2.00 mg/L (as CaCO <sub>3</sub> )
Resolution	0.01 mg/L
Accuracy	±0.11 mg/L ± 5% of reading at 25 °C
Wavelength	523 nm
Cuvette type	22 mm diameter
Method	Adaptation of the Standard Methods for the Examination of Water and Wastewater, 18 <sup>th</sup> Edition, EDTA Colorimetric Method
Method ID	#040

### REQUIRED REAGENTS

Code	Description	Quantity
HI93719A-0	Magnesium Hardness Reagent A	0.5 mL
HI93719B-0	Magnesium Hardness Reagent B	0.5 mL
HI93719C-0	Magnesium Hardness Reagent C	1 drop
HI93719D-0	Magnesium Hardness Reagent D	1 drop

### REAGENT SETS

HI93719-01	Reagents for 100 tests
HI93719-03	Reagents for 300 tests

For other accessories see Accessories section.

### MEASUREMENT PROCEDURE

- Select the [Hardness \(Magnesium\)](#) method using the procedure described in the Factory Methods section.

- Rinse a graduated beaker several times with unreacted sample, before filling it to the 50 mL mark with the sample.

- Add 0.5 mL of [HI93719A-0](#) Magnesium Hardness Reagent A. Swirl to mix the solution.

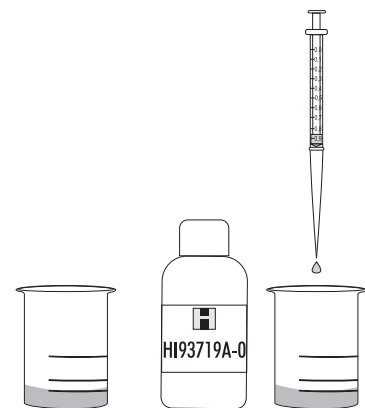

- Add 0.5 mL of [HI93719B-0](#) Magnesium Hardness Reagent B. Swirl to mix the solution. Use this solution to rinse 2 cuvettes. Fill both cuvettes up to the 10 mL mark.

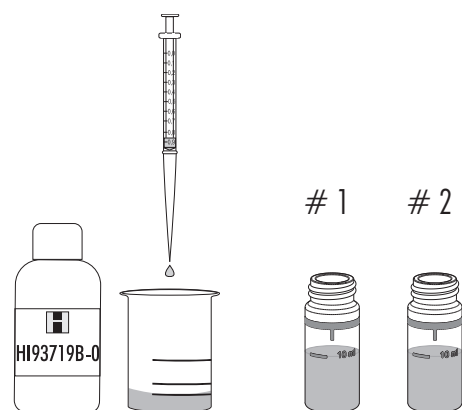

- Add 1 drop of **HI93719C-0** Magnesium Hardness Reagent C to one cuvette (#1).

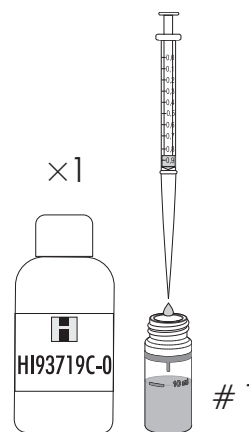

- Replace the plastic stopper and the cap. Invert the cuvette several times to mix the solution. This is the blank.



- Add 1 drop of **HI93719D-0** Magnesium Hardness Reagent D to the second cuvette (#2). Replace the plastic stopper and the cap. Invert the cuvette several times to mix the solution. This is the sample.

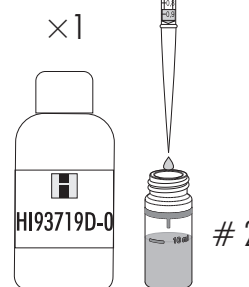

- Insert the blank (#1) into the holder and close the lid.

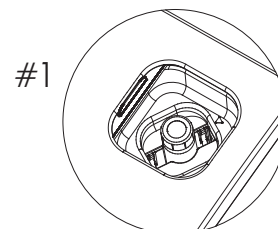

- Press **ZERO**. The display will show “-0-” when the meter is zeroed and ready for measurement.



- Remove the blank cuvette (#1), insert the second cuvette (#2) into the holder and close the lid.

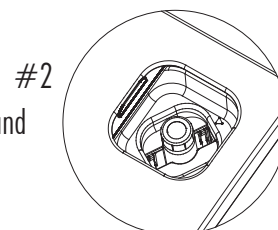

- Press **READ** to start the reading. The instrument displays concentration in mg/L of calcium carbonate ( $\text{CaCO}_3$ ).

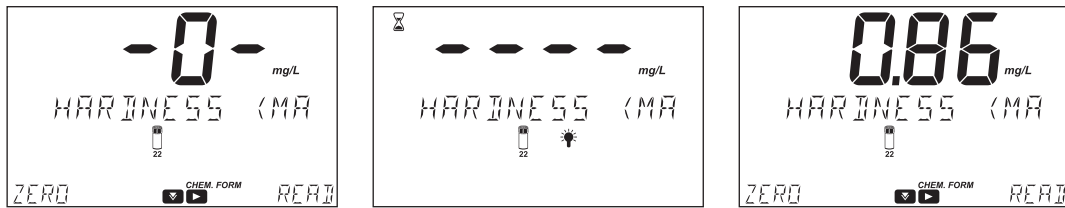

- Press the  $\nabla$  key to view the wavelength, method ID, date and time.
- Press the  $\blacktriangleright$  key to view the chemical formula.
- Press the  $\blacktriangle$  key to convert the results to English ( $^{\circ}\text{e}$ ), French ( $^{\circ}\text{f}$ ) or German ( $^{\circ}\text{dH}$ ) degrees.

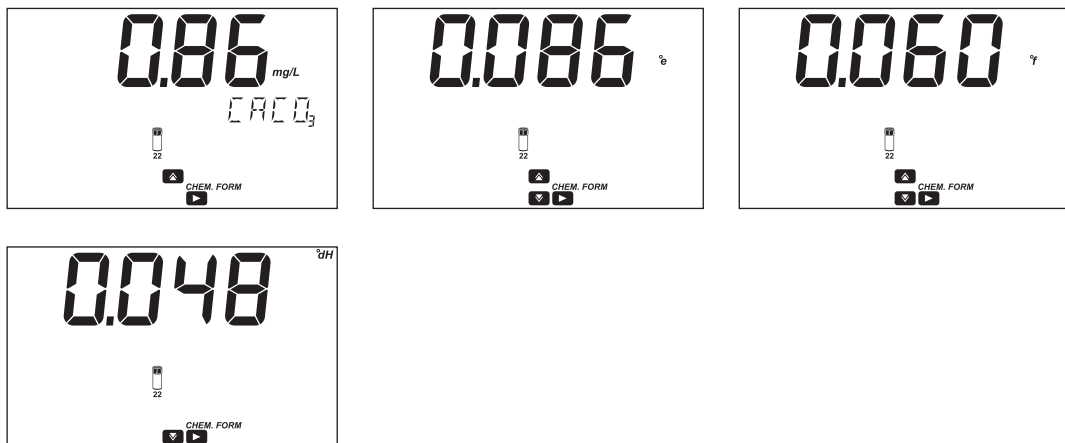

- Press the  $\blacktriangleright$  key to return to the measurement screen.

**Note:** This test will detect any calcium contamination in the beaker, measuring syringes or sample cells. To test cleanliness repeat the test multiple times until consistent results are obtained.

### SAMPLE DILUTION

This method is designed to determine low levels of hardness, typically found in water purification systems.

When testing some other sources of water, it is not uncommon to come across levels of hardness that are greater than the range of this method.

This problem can be overcome through dilution. Dilutions must be performed with hardness-free water or the readings will be erroneous.

To reduce the level of hardness by a factor of one hundred a dilution is performed as follows:

- Fill a 1 mL syringe with the sample
- Add 0.5 mL of sample to a clean, dry 50 mL beaker
- Fill the beaker up to the 50 mL mark with hardness-free water

### INTERFERENCES

Interference may be caused by:

- Excessive amounts of heavy metals



## Hardness, Total Low Range

### SPECIFICATIONS

Range	0 to 250 mg/L (as CaCO <sub>3</sub> )
Resolution	1 mg/L
Accuracy	± 5 mg/L ± 4% of reading at 25 °C
Wavelength	466 nm
Cuvette type	22 mm diameter
Method	Adaptation of the EPA Method 130.1
Method ID	#041

### REQUIRED REAGENTS

Code	Description	Quantity
HI93735IND-0	Hardness Indicator Reagent	0.5 mL
HI93735A-LR	Hardness Low Range Reagent A	9 mL
HI93735B-0	Hardness Buffer Reagent B	2 drops
HI93735C-0	Fixing Reagent	1 packet

### REAGENT SETS

HI93735-00 Reagents for 100 tests (LR)

HI93735-0 Reagents for 300 tests (LR - 100 tests, MR - 100 tests, HR - 100 tests)

For other accessories see Accessories section.

### MEASUREMENT PROCEDURE

- Select the **Hardness Total LR** method using the procedure described in the Factory Methods section.

- Add 0.5 mL of unreacted sample to the cuvette. Add 0.5 mL of **HI93735IND-0** Hardness Indicator Reagent.

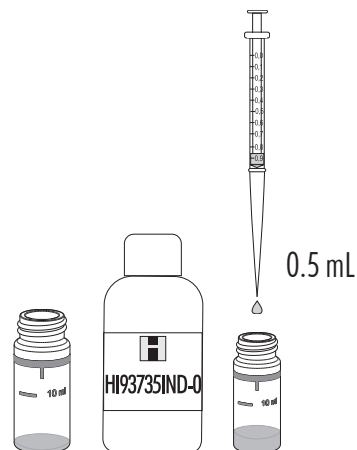

- Use a plastic pipette and fill the cuvette up to the 10 mL mark with **HI93735A-LR** Hardness Low Range Reagent A.

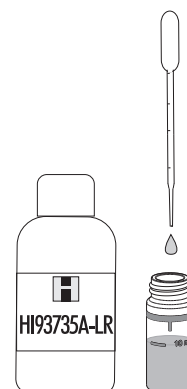

- Add 2 drops of **HI93735B-0** Hardness Buffer Reagent B. Replace the plastic stopper and the cap. Invert 5 times to mix.

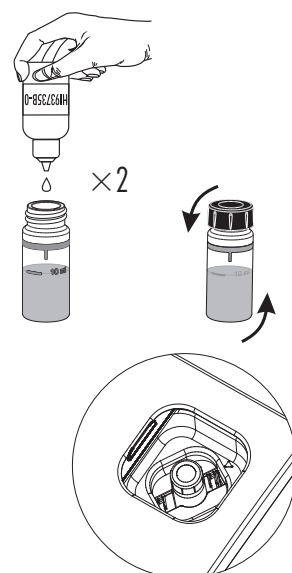

- Insert the cuvette into the holder and close the lid.

- Press **ZERO**. The display will show “-0-” when the meter is zeroed and ready for measurement.



- Remove the cuvette.

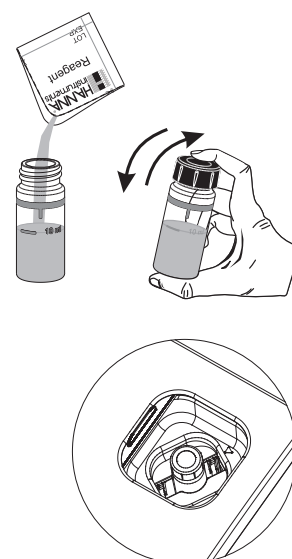

- Add one packet of **HI93735C-0** Fixing Reagent. Replace the plastic stopper and the cap. Shake gently to mix 20 seconds.



- Insert the cuvette into the holder and close the lid.

- Press **READ** to start the reading. The instrument displays concentration in **mg/L** of calcium carbonate ( $\text{CaCO}_3$ ).



- Press the  key to view the wavelength, method ID, date and time.
- Press the  key to view the chemical formula.
- Press the  key to convert the results to **English (°e)**, **French (°f)** or **German (°dH)** degrees.

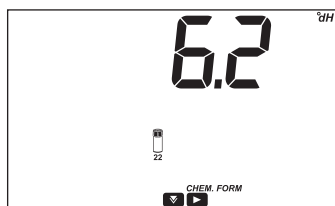
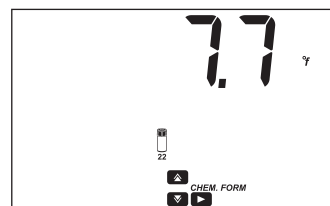
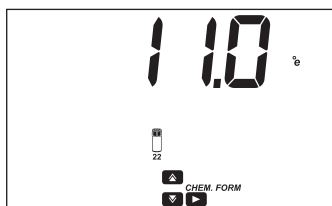
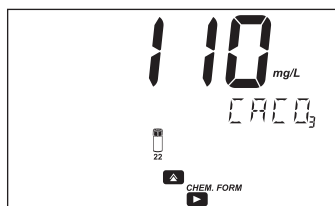

- Press the  key to return to the measurement screen.

## INTERFERENCES

Interference may be caused by:

- Excessive amounts of heavy metals

## Hardness, Total Medium Range

### SPECIFICATIONS

Range	200 to 500 mg/L (as CaCO <sub>3</sub> )
Resolution	1 mg/L
Accuracy	±7 mg/L ± 3% of reading at 25 °C
Wavelength	466 nm
Cuvette type	22 mm diameter
Method	Adaptation of the EPA Method 130.1
Method ID	#042

### REQUIRED REAGENTS

Code	Description	Quantity
HI93735IND-0	Hardness Indicator Reagent	0.5 mL
HI93735A-MR	Hardness Medium Range Reagent A	9 mL
HI93735B-0	Hardness Buffer Reagent B	2 drops
HI93735C-0	Fixing Reagent	1 packet

### REAGENT SETS

HI93735-01 Reagents for 100 tests (MR)

HI93735-0 Reagents for 300 tests (LR - 100 tests, MR - 100 tests, HR - 100 tests)

For other accessories see Accessories section.

### MEASUREMENT PROCEDURE

- Select the **Hardness Total MR** method using the procedure described in the Factory Methods section.

- Add 0.5 mL of unreacted sample to the cuvette. Add 0.5 mL of **HI93735IND-0** Hardness Indicator Reagent.

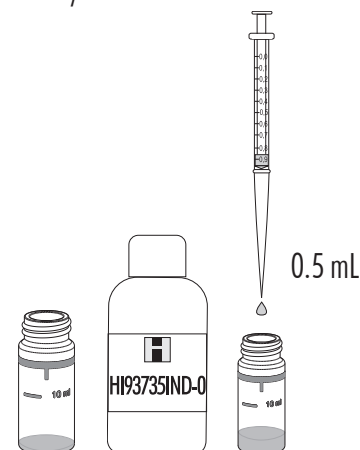

- Use a plastic pipette and fill the cuvette up to the 10 mL mark with **HI93735A-MR** Hardness Medium Range Reagent A.

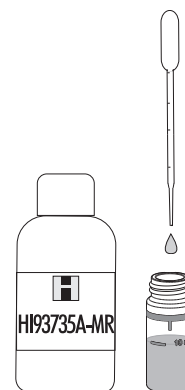

- Add 2 drops of **HI93735B-0** Hardness Buffer Reagent B. Replace the plastic stopper and the cap. Invert 5 times to mix.

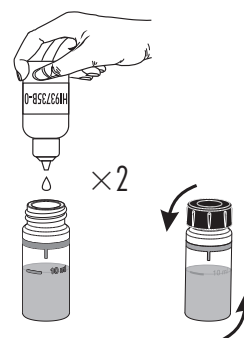

- Insert the cuvette into the holder and close the lid.

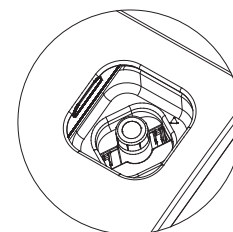

- Press **ZERO**. The display will show “-0-” when the meter is zeroed and ready for measurement.

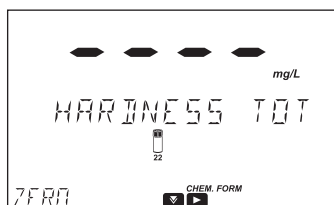

- Remove the cuvette and add one packet of **HI93735C-0** Fixing Reagent. Replace the plastic stopper and the cap. Shake gently for 20 seconds to mix the solution.

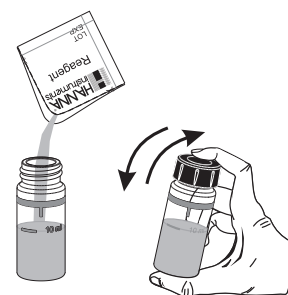

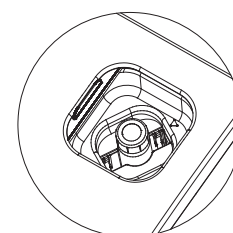

- Insert the cuvette into the holder and close the lid.

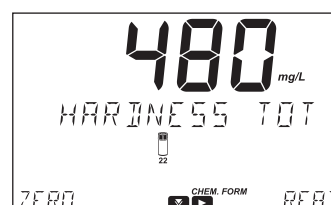
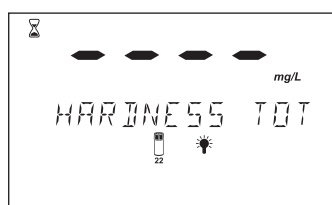
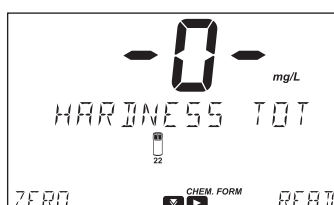

- Press **READ** to start the reading. The instrument displays concentration in **mg/L** of calcium carbonate ( $\text{CaCO}_3$ ).



- Press the  key to view the wavelength, method ID, date and time.
- Press the  key to view the chemical formula.
- Press the  key to convert the results to **English (°e)**, **French (°f)** or **German (°dH)** degrees.

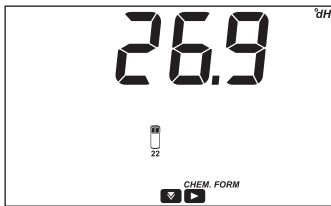
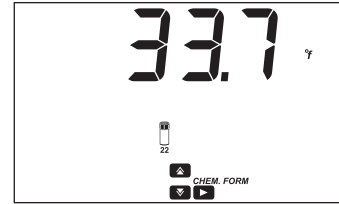
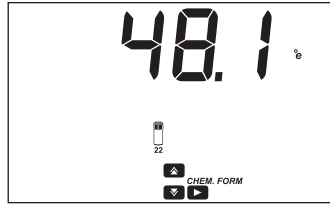
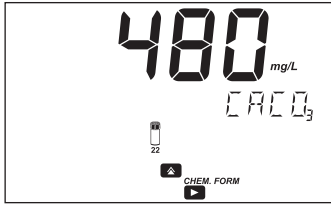

- Press the  key to return to the measurement screen.

### INTERFERENCES

Interference may be caused by:

- Excessive amounts of heavy metals

## Hardness, Total High Range

### SPECIFICATIONS

Range	400 to 750 mg/L (as CaCO <sub>3</sub> )
Resolution	1 mg/L
Accuracy	±10 mg/L ±2% of reading at 25 °C
Wavelength	466 nm
Cuvette type	22 mm diameter
Method	Adaptation of the EPA Method 130.1
Method ID	#043

### REQUIRED REAGENTS

Code	Description	Quantity
HI93735IND-0	Hardness Indicator Reagent	0.5 mL
HI93735A-HR	Hardness High Range Reagent A	9 mL
HI93735B-0	Hardness Buffer Reagent B	2 drops
HI93735C-0	Fixing Reagent	1 packet

### REAGENT SETS

HI93735-02 Reagents for 100 tests (HR)

HI93735-0 Reagents for 300 tests (LR - 100 tests, MR - 100 tests, HR - 100 tests)

For other accessories see Accessories section.

### MEASUREMENT PROCEDURE

- Select the **Hardness Total HR** method using the procedure described in the Factory Methods section.

- Add 0.5 mL of unreacted sample to the cuvette. Add 0.5 mL of **HI93735IND-0** Hardness Indicator Reagent.

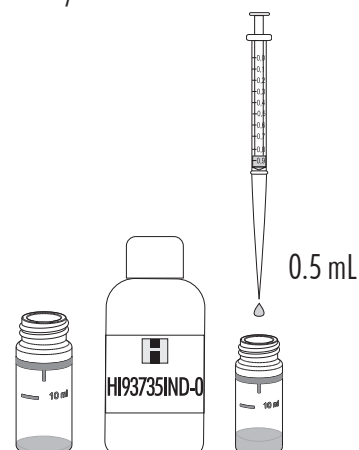

- Use a plastic pipette and fill the cuvette up to the 10 mL mark with **HI93735A-HR** Hardness High Range Reagent A.

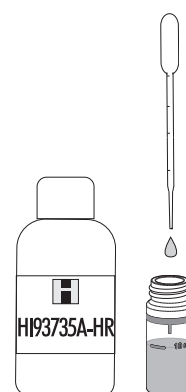

- Add 2 drops of **HI93735B-0** Hardness Buffer Reagent B. Replace the plastic stopper and the cap. Invert 5 times to mix.

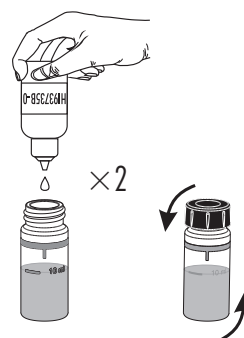

- Insert the cuvette into the holder and close the lid.

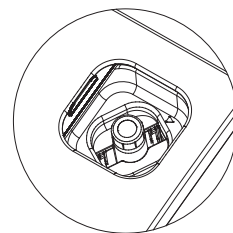

- Press **ZERO**. The display will show “-0-” when the meter is zeroed and ready for measurement.



- Remove the cuvette and add the contents of one packet of **HI93735C-0** Fixing Reagent. Replace the plastic stopper and the cap. Shake gently for 20 seconds to mix the solution.

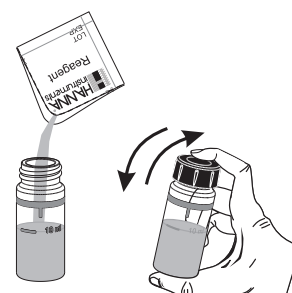

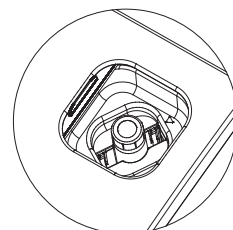

- Insert the cuvette into the holder and close the lid.

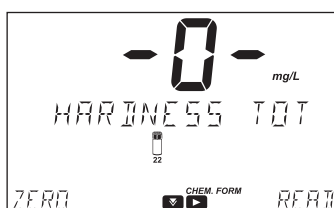

- Press **READ** to start the reading. The instrument displays concentration in **mg/L** of calcium carbonate ( $\text{CaCO}_3$ ).





- Press the  key to view the wavelength, method ID, date and time.
- Press the  key to view the chemical formula.
- Press the  key to convert the results to English (°e), French (°f) or German (°dH) degrees.

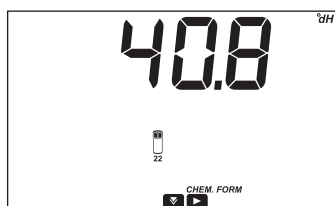
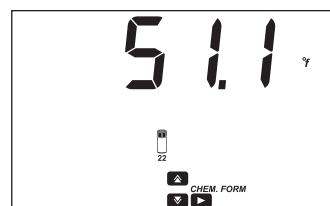
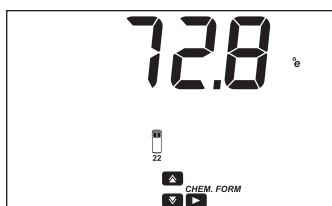
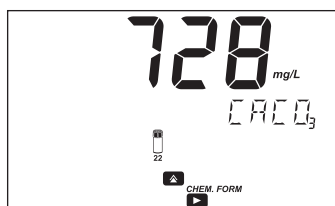

- Press the  key to return to the measurement screen.

## INTERFERENCES

Interference may be caused by:

- Excessive amounts of heavy metals

## Hydrazine

### SPECIFICATIONS

Range	0 to 400 $\mu\text{g/L}$ (as $\text{N}_2\text{H}_4$ )
Resolution	1 $\mu\text{g/L}$
Accuracy	$\pm 3 \mu\text{g/L} \pm 3 \%$ of reading at 25°C
Wavelength	466 nm
Cuvette type	22 mm diameter
Method	Adaptation of the ASTM Manual of Water and Environmental Technology, Method D1385, p-Dimethylaminobenzaldehyde Method
Method ID	#044

### REQUIRED REAGENT

Code	Description	Quantity
HI93704-0	Hydrazine Reagent	24 drops

### REAGENT SETS

HI93704-01	Reagents for 100 tests
HI93704-03	Reagents for 300 tests

For other accessories see Accessories section.

### MEASUREMENT PROCEDURE

- Select the [Hydrazine](#) method using the procedure described in the Factory Methods section.

- Fill the first cuvette (#1) with 10 mL of deionized water (up to the mark). This is the blank.

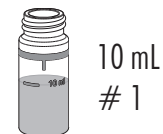

- Fill a second cuvette (#2) with 10 mL of unreacted sample (up to the mark).

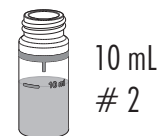

- Add 12 drops of the [HI93704-0](#) Hydrazine Reagent to each cuvette. Replace the plastic stoppers and the caps. Shake gently to mix (about 30 seconds).

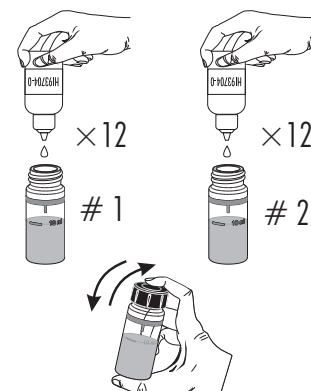

- Insert the first cuvette (#1) into the holder and close the lid.

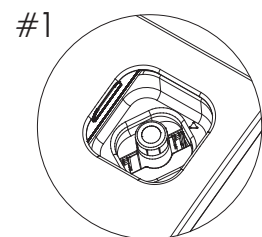

- Press the ◀ key to access the timer menu. Press **START** to start Timer 1, the display will show the countdown prior to zeroing the blank or wait 12 minutes.
- Press **ZERO**, the display will show “-0-” when the meter is zeroed and ready for measurement.

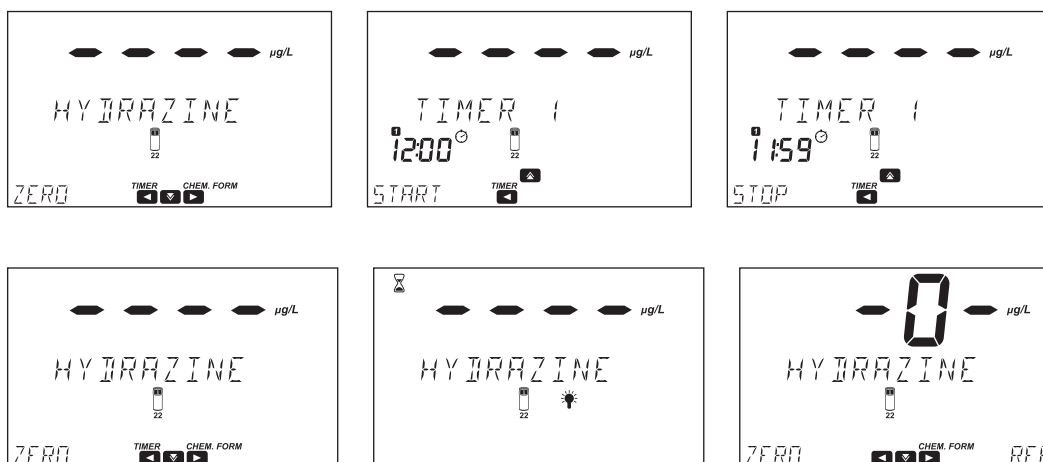

- Remove the blank cuvette.
- Insert the second cuvette with the reacted sample (#2) into the holder and close the lid.
- Press **READ** to start the reading. The instrument displays concentration in  $\mu\text{g/L}$  of hydrazine ( $\text{N}_2\text{H}_4$ ).

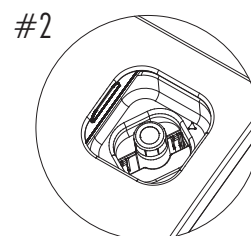

- Press the ▼ key to view the wavelength, method ID, date and time.
- Press the ▶ key to view the chemical formula.

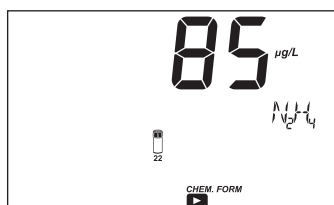

- Press the ▶ key to return to the measurement screen.

## INTERFERENCES

Interference may be caused by:

- Highly colored samples
- Highly turbid samples
- Aromatic amines

## Iodine

### SPECIFICATIONS

Range	0.0 to 12.5 mg/L (as I <sub>2</sub> )
Resolution	0.1 mg/L
Accuracy	±0.1 mg/L ±5% of reading at 25 °C
Wavelength	525 nm
Cuvette type	22 mm diameter
Method	Adaptation of the Standard Methods for the Examination of Water and Wastewater, 18 <sup>th</sup> Edition, DPD Method
Method ID	#045

### REQUIRED REAGENTS

Code	Description	Quantity
HI93718-0	Iodine Reagent	1 packet

### REAGENT SETS

HI93718-01	Reagents for 100 tests
HI93718-03	Reagents for 300 tests

For other accessories see Accessories section.

### MEASUREMENT PROCEDURE

- Select the **Iodine** method using the procedure described in the Factory Methods section.

- Fill the cuvette with 10 mL of unreacted sample (up to the mark). Replace the plastic stopper and the cap.



10 mL

- Insert the cuvette into the holder and close the lid.

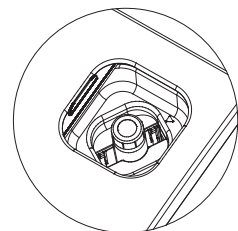

- Press **ZERO**. The display will show “-0-” when the meter is zeroed and ready for measurement.

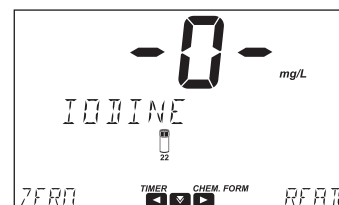
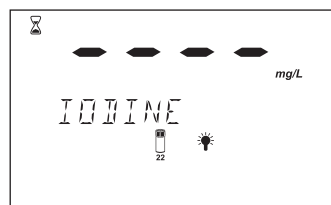
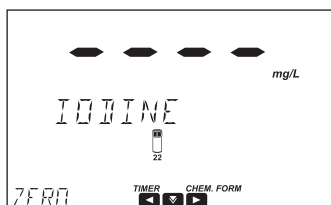

- Remove the cuvette and add one packet of **HI93718-0** Iodine Reagent. Replace the plastic stopper and the cap. Shake gently for about 20 seconds to dissolve most of the reagent.

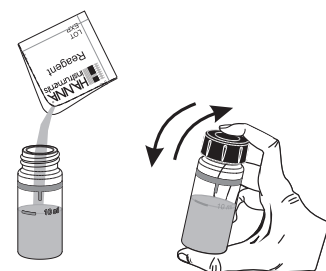

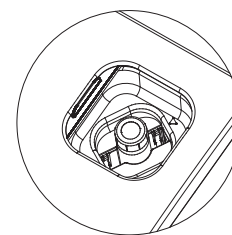

- Insert the cuvette into the holder and close the lid.
- Press the ◀ key to access the timer menu. Press **START** to start Timer 1, the display will show the countdown prior to measurement or wait 2 minutes and 30 seconds.
- Press **READ** to start the reading. The instrument displays the results in mg/L of iodine (I<sub>2</sub>).

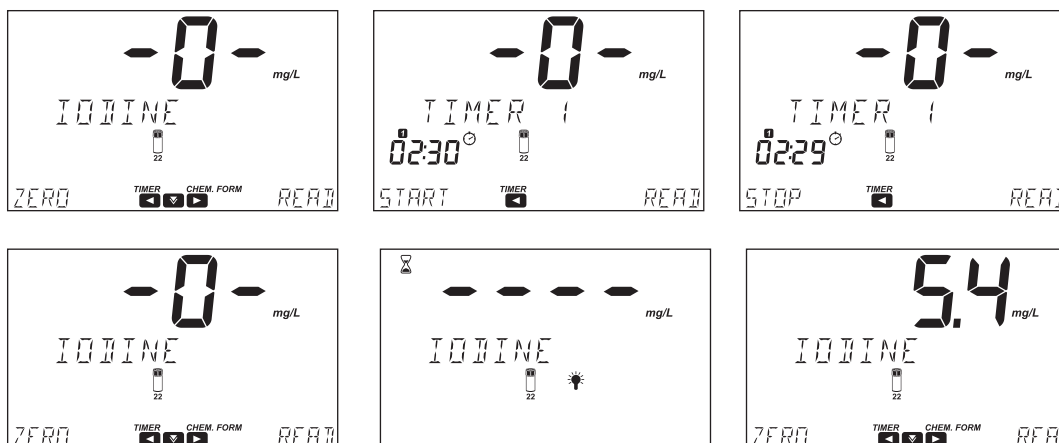

- Press the ▼ key to view the wavelength, method ID, date and time.
- Press the ▶ key to view the chemical formula.

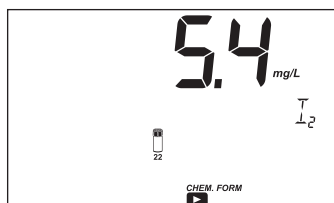

- Press the ▶ key to return to the measurement screen.

## INTERFERENCES

Interference may be caused by:

- Bromine, Chlorine, Oxidized forms of Chromium, Manganese and Ozone
- Hardness greater than 500 mg/L CaCO<sub>3</sub>, to remove the interference shake the sample for approximately 2 minutes after adding the reagent
- Alkalinity greater than 250 mg/L CaCO<sub>3</sub> or acidity greater than 150 mg/L CaCO<sub>3</sub>, the color of the sample may develop only partially, or may rapidly fade, to remove the interference neutralize the sample with diluted HCl or NaOH

## Iron Low Range

### SPECIFICATIONS

Range	0.000 to 1.600 mg/L (as Fe)
Resolution	0.001 mg/L
Accuracy	$\pm 0.010$ mg/L $\pm 8\%$ of reading at 25 °C
Wavelength	575 nm
Cuvette type	22 mm diameter
Method	Adaptation of the TPTZ Method
Method ID	#046

### REQUIRED REAGENTS

Code	Description	Quantity
HI93746-0	Iron Low Range Reagent	2 packets

### REAGENT SETS

HI93746-01	Reagents for 50 tests
HI93746-03	Reagents for 150 tests

For other accessories see Accessories section.

### MEASUREMENT PROCEDURE

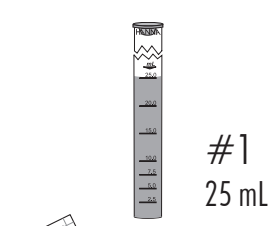
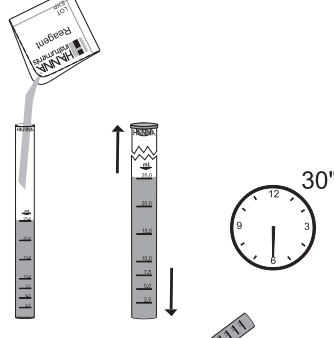
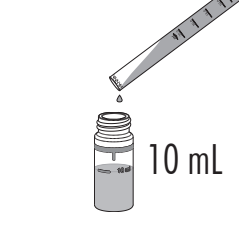
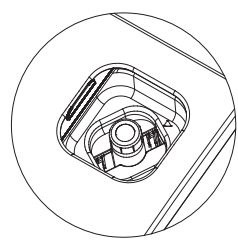
- Select the [Iron LR](#) method using the procedure described in the Factory Methods section.
- Fill one graduated mixing cylinder up to the 25 mL mark with deionized water.
 
- Add one packet of [HI93746-0](#) Iron Low Range Reagent, close the graduated mixing cylinder. Shake vigorously for 30 seconds. This is the blank.
 
- Fill a cuvette with 10 mL of the blank (up to the mark). Replace the plastic stopper and the cap.
 
- Insert the cuvette into the holder and close the lid.
 

- Press **ZERO**. The display will show “-0-” when the meter is zeroed and ready for measurement.

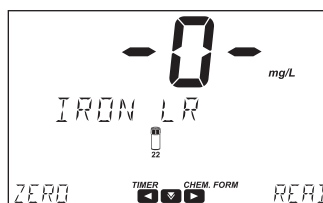
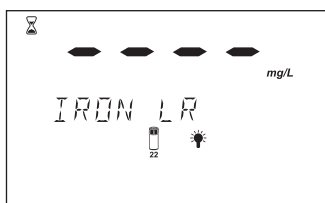
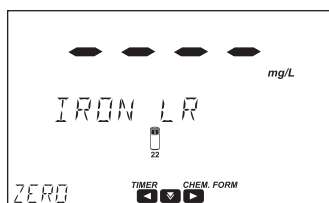

- Remove the cuvette.
- Fill another graduated glass cylinder up to the 25 mL mark with the sample.

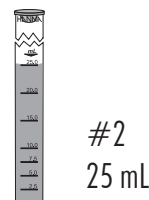
#2  
25 mL

- Add one packet of **HI93746-0** Iron Low Range Reagent, close the graduated glass cylinder. Shake vigorously for 30 seconds. This is the reacted sample.

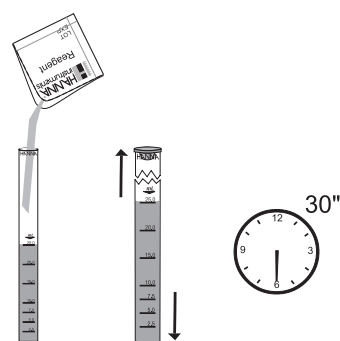

- Fill a cuvette with 10 mL of the reacted sample (up to the mark). Replace the plastic stopper and the cap.

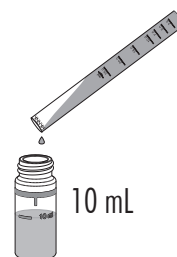

- Insert the sample into the holder and close the lid.

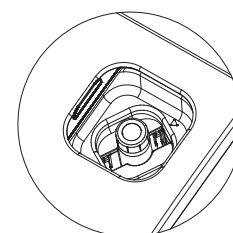

- Press the **◀** key to access the timer menu. Press **START** to start Timer 1, the display will show the countdown prior to measurement or wait 30 seconds.
- Press **READ** to start the reading. The instrument displays the results in **mg/L** of iron (Fe).

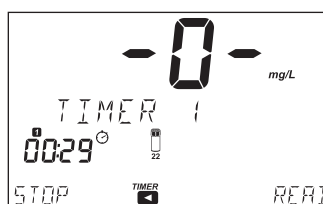
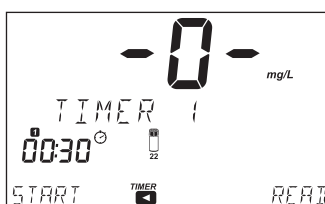
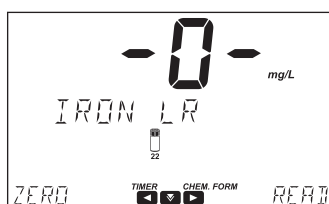

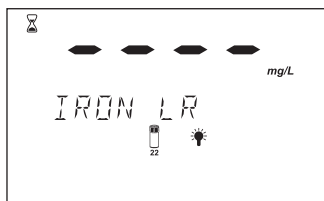
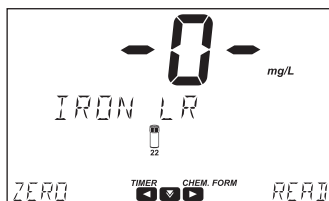

- Press the key to view the wavelength, method ID, date and time.
- Press the key to view the chemical formula.

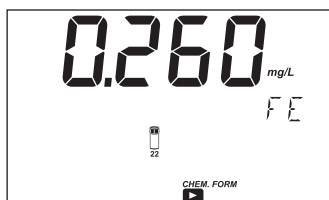

- Press the key to return to the measurement screen.

### INTERFERENCES

Interference may be caused by:

- Manganese above 50.0 mg/L
- Cadmium, Molybdenum above 4.0 mg/L
- Cyanide above 2.8 mg/L
- Chromium<sup>6+</sup> above 1.2 mg/L
- Nickel above 1.0 mg/L
- Nitrite ion above 0.8 mg/L
- Copper above 0.6 mg/L
- Mercury above 0.4 mg/L
- Chromium<sup>3+</sup> above 0.25 mg/L
- Cobalt above 0.05 mg/L
- Sample pH should be between 3 and 4 to avoid fading or turbidity formation



## Iron High Range

### SPECIFICATIONS

Range	0.00 to 5.00 mg/L (as Fe)
Resolution	0.01 mg/L
Accuracy	$\pm 0.04$ mg/L $\pm 2\%$ of reading at 25 °C
Wavelength	525 nm
Cuvette type	22 mm diameter
Method	Adaptation of Standard Methods for the Examination of Water and Wastewater, 23 <sup>rd</sup> Edition, 3500-Fe B, Phenanthroline Method
Method ID	#047

### REQUIRED REAGENTS

Code	Description	Quantity
HI93721-0	Iron High Range Reagent	1 packet

### REAGENT SETS

HI93721-01 Reagents for 100 tests

HI93721-03 Reagents for 300 tests

For other accessories see Accessories section.

### MEASUREMENT PROCEDURE

- Select the **Iron HR** method using the procedure described in the Factory Methods section.

- Fill the cuvette with 10 mL of unreacted sample (up to the mark). Replace the plastic stopper and the cap.

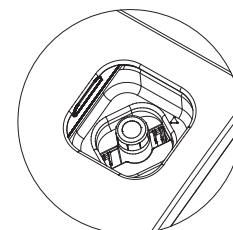

- Insert the cuvette into the holder and close the lid.

- Press **ZERO**. The display will show “-0-” the meter is zeroed and ready for measurement.

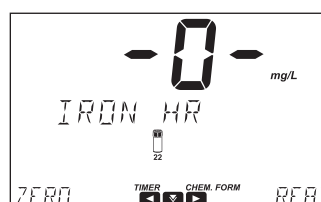
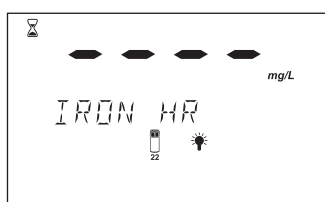
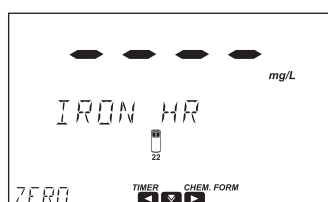

- Remove the cuvette and add one packet of **HI93721-0** Iron High Range Reagent. Replace the plastic stopper and the cap. Shake until powder is completely dissolved.

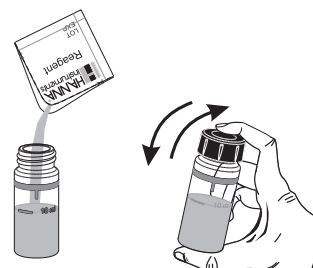

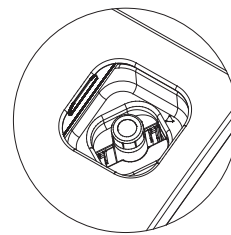

- Insert the cuvette into the holder and close the lid.
- Press the ◀ key to access the timer menu. Press **START** to start Timer 1, the display will show the countdown prior to measurement or wait 3 minutes.
- Press **READ** to start the reading. The instrument displays the results in mg/L of iron (Fe).

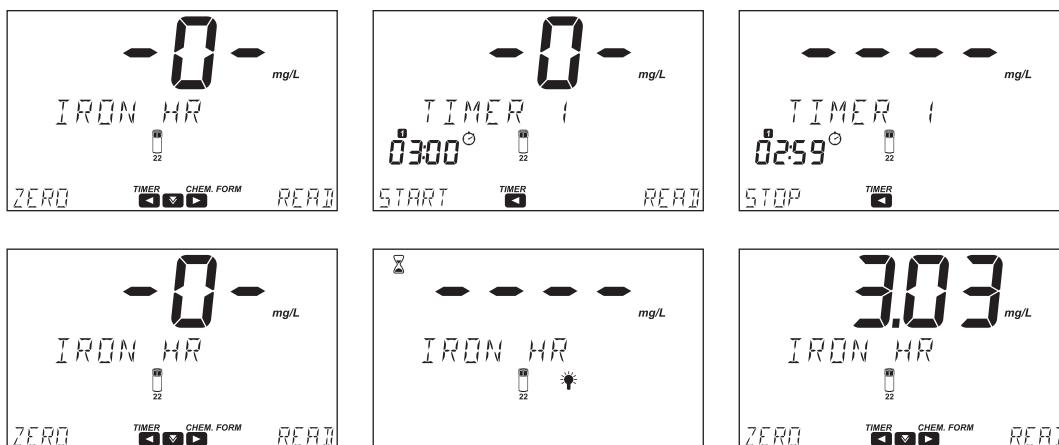

- Press the ▼ key to view the wavelength, method ID, date and time.
- Press the ► key to view the chemical formula.

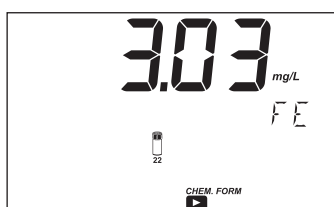

- Press the ► key to return to the measurement screen.

## INTERFERENCES

Interference may be caused by:

- Chloride above 185000 ppm.
- Calcium above 10000 ppm (as CaCO<sub>3</sub>)
- Magnesium above 100000 ppm (as CaCO<sub>3</sub>)
- Molybdate Molybdenum above 50 ppm

## Iron (II) (Ferrous)

### SPECIFICATIONS

Range	0.00 to 6.00 mg/L (as Fe <sup>2+</sup> )
Resolution	0.01 mg/L
Accuracy	±0.10 mg/L ±2% of reading at 25 °C
Wavelength	525 nm
Cuvette type	22 mm diameter
Method	Adaptation of Standard Methods for the Examination of Water and Wastewater, 23 <sup>rd</sup> Edition, 3500-Fe B, Phenanthroline Method
Method ID	#089

### REQUIRED REAGENT

Code	Description	Quantity
HI96776-0	Iron(II) Reagent	1 packet

### REAGENT SETS

HI96776-01 Reagents for 100 tests

HI96776-03 Reagents for 300 tests

For other accessories see Accessories section.

### PRINCIPLE

In aqueous solution, reactive ferrous iron (Fe<sup>2+</sup>) reacts with 1,10-phenanthroline to form an orange-red complex.

### APPLICATION

Surface water, drinking water, mineral and groundwater, process control

### SIGNIFICANCE & USE

Surface water typically contains up to 0.7 mg/L of iron. Drinking water typically contains up to 0.3 mg/L of iron, but this level may increase significantly if plumbing fixtures contain iron. In well-oxygenated, non-acidic waters, iron exists mainly in the ferric form (Fe<sup>3+</sup>) and will precipitate as iron oxide hydroxide (FeO(OH)). However, anoxic water may have high levels of dissolved ferrous iron (Fe<sup>2+</sup>) which could precipitate in heating/cooling systems or other equipment after exposure to air.

The Iron(II) method measures the ferrous (Fe<sup>2+</sup>) form of iron.

### MEASUREMENT PROCEDURE

**Warning:** Method is temperature-dependent. Sample temperature must be between 18 and 22 °C.

- Select the **Iron (II)** method using the procedure described in the Factory Methods section.
- Fill a cuvette with 10 mL of unreacted sample (up to the mark). Replace the plastic stopper and the cap.

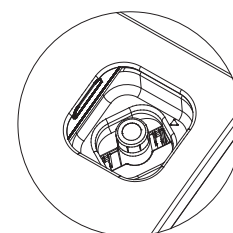

- Insert the cuvette into the holder and close the lid.

- Press **ZERO**. The display will show “-0-” when the meter is zeroed and ready for measurement.

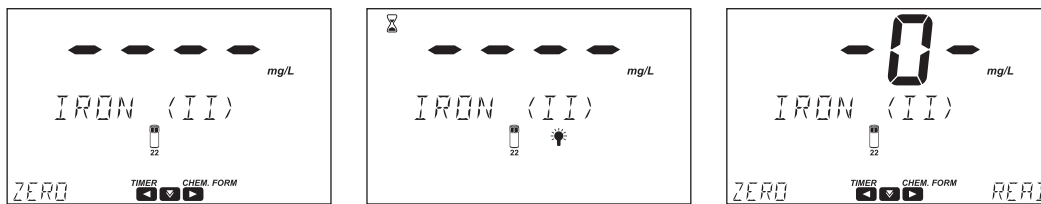

- Remove the cuvette and add one packet of **HI96776-0** Iron(II) Reagent. Replace the plastic stopper and the cap. Shake gently for 30 seconds.

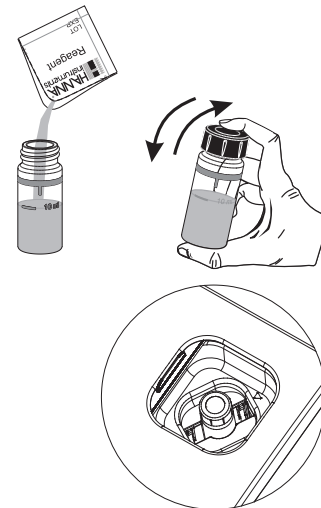

- Insert the cuvette into the holder and close the lid.
- Press the ◀ key to access the timer menu. Press **START** to start Timer 1, the display will show the countdown prior to measurement or wait 3 minutes and press **READ**. The meter displays the results in mg/L of Iron ( $\text{Fe}^{2+}$ ).

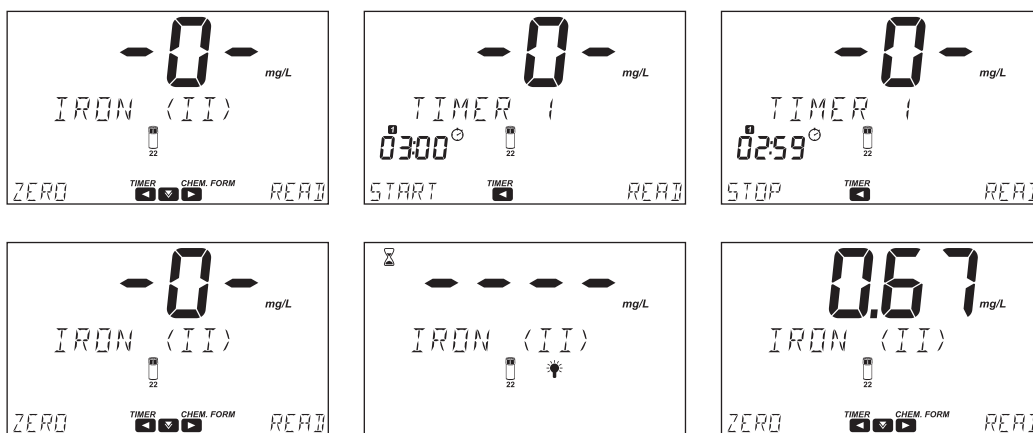

**Warning:** Timing is critical for accurate measurement. Reaction times beyond 3 minutes may cause some ferric iron ( $\text{Fe}^{3+}$ ) to also react, producing false high measurements.

- Press the ▼ key to view the wavelength, method ID, date and time.
- Press the ▶ key to view the chemical formula.

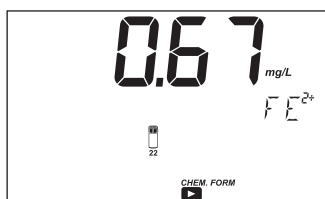

- Press the ▶ key to return to the measurement screen.

## INTERFERENCES

Interference may be caused by:

- Chloride, Sulfate above 1000 mg/L
- Ammonium, Calcium, Potassium, Sodium above 500 mg/L
- Silver above 100 mg/L
- Carbonate, Chromium(III) and (VI), Cobalt, Lead, Mercury, Nitrate, Zinc above 50 mg/L
- Nickel above 25 mg/L
- Copper above 10 mg/L
- Tin above 5 mg/L
- Extreme pH or highly buffered samples, the pH of the sample must be between 3.8 and 5.5 after addition of the reagent

## Iron (13 mm Vial)

### SPECIFICATIONS

Range	0.00 to 6.00 mg/L (as Fe)
Resolution	0.01 mg/L
Accuracy	$\pm 0.10$ mg/L or $\pm 3\%$ of reading at 25°C
Wavelength	525 nm
Cuvette type	13 mm diameter
Method	Adaptation of Standard Methods for the Examination of Water and Wastewater, 23 <sup>rd</sup> Edition, 3500-Fe B, Phenanthroline Method
Method ID	#096

### REQUIRED REAGENT

Code	Description	Quantity
HI96786V-0	Iron Reagent Vial	1 vial
HI96786-0	Iron Powder Reagent	1 packet

### REAGENT SETS

HI96786-25 Reagents for 25 tests

For other accessories see Accessories section.

**Note:** Store the unused vials in their packaging in a cool and dark place.

### PRINCIPLE

Ferrous iron ( $\text{Fe}^{2+}$ ) reacts with 1,10-phenanthroline to form an orange - red colored complex. All  $\text{Fe}^{3+}$  dissolved and not complexed or chelated is converted to ferrous iron ( $\text{Fe}^{2+}$ ).

### APPLICATION

Surface water, drinking water, groundwater, process control, wastewater, pool water

### SIGNIFICANCE & USE

Iron is an abundant, naturally-occurring element found in soils, streams, surface water and groundwater. High levels of iron in drinking water can cause objectionable taste and can stain plumbing and laundry. Iron in drinking water and wastewater is regulated by the EPA and other regulatory bodies.

### MEASUREMENT PROCEDURE

- Select the **Iron (13 mm)** method using the procedure described in the Factory Methods section.
- Insert the 13 mm vial adapter using the procedure described in the Cuvette & Vial Adapters section.
- Remove the cap from a **HI96786V-0** Iron Reagent Vial.
- Add 5 mL of sample to the vial, while keeping the vial at a 45-degree angle.
- Replace the cap.
- Insert the **HI96786V-0** Iron Reagent Vial into the adapter.

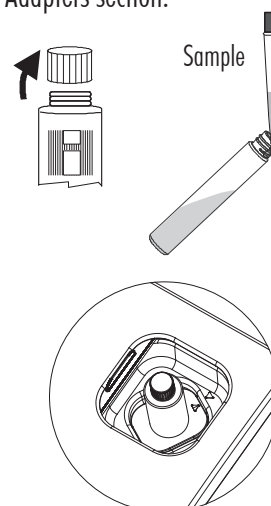

- Press **ZERO**. The display will show “-0-” when the meter is zeroed and ready for measurement.

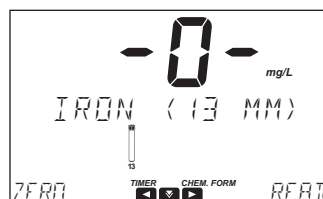
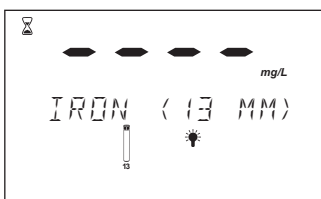
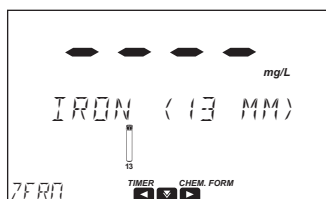

- Remove the vial from the meter.
- Remove the cap and add one packet of **HI96786-0** Iron Powder Reagent.
- Replace the cap and shake until powder is dissolved.
- Wipe the vial thoroughly with **HI731318** microfiber cleaning cloth or a lint-free wipe prior to insertion.

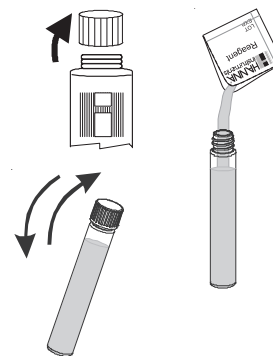

- Insert the vial into the adapter.

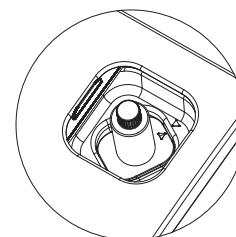

- Press the ◀ key to access the timer menu. Press **START** to start Timer 1, the display will show the countdown prior to measurement, or wait 3 minutes.
- Press **READ** to start the reading. The instrument displays the result in **mg/L** of Iron (Fe).

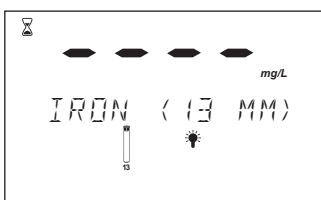
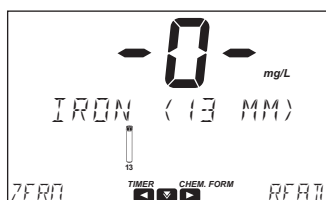
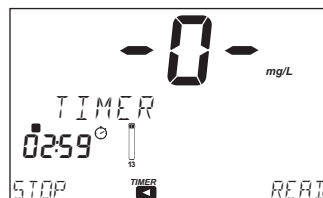
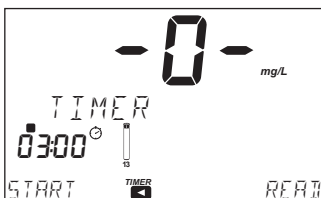
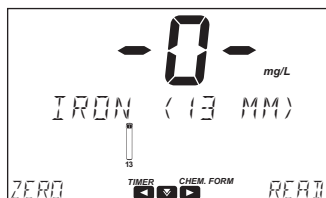

- Press the ▼ key to view the wavelength, method ID, date and time.
- Press the ▶ key to view the chemical formula.

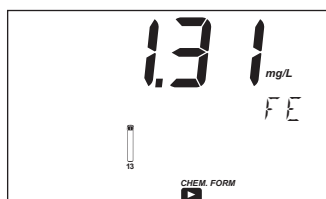

- Press the ▶ key to return to the measurement screen.

**INTERFERENCES**

Interference may be caused by:

- Chloride above 185000 mg/L
- Hardness Calcium above 10000 mg/L  $\text{CaCO}_3$
- Hardness Magnesium above 100000 mg/L  $\text{CaCO}_3$
- Molybdate Molybdenum above 50 mg/L



## Iron Total (13 mm Vial)

### SPECIFICATIONS

Range	0.00 to 7.00 mg/L (as Fe)
Resolution	0.01 mg/L
Accuracy	$\pm 0.20$ mg/L or $\pm 3\%$ of reading, whichever is greater
Wavelength	525 nm
Cuvette type	13 mm diameter
Method	Adaptation of Standard Methods for the Examination of Water and Wastewater, 23 <sup>rd</sup> Edition, 3500-Fe B, Phenanthroline Method
Method ID	#090

### REQUIRED REAGENT

Code	Description	Quantity
HI96778V-0*	Total Iron Digestion Vial	1 vial
HI96778A-0	Total Iron Reagent A	1 mL
HI96778B-0	Total Iron Reagent B	1 packet
PERSULFATE/I	Potassium Persulfate Reagent	1 packet

\*Reagent vial identification: IRON, red label

### REAGENT SETS

HI96778-25 Reagents for 25 tests

For other accessories see Accessories section.

### PRINCIPLE

Digestion of the sample with sulfuric acid and persulfate liberates iron from organic and inorganic complexes. After digestion, the iron reacts with 1,10-phenanthroline to form an orange-red complex.

### APPLICATION

Surface water, drinking water, groundwater, process control, wastewater

### SIGNIFICANCE & USE

Iron is an abundant, naturally-occurring element found in soils, streams, surface waters and groundwater. High levels of iron in drinking water can cause objectionable taste and can stain plumbing and laundry. Iron in drinking water and wastewater is regulated by the EPA and other regulatory bodies.

For samples that contain complexed or chelated iron or suspended iron, such as typical wastewater samples, digestion of the sample is required to allow all of the iron to react with the reagent.

The Total Iron method measures all forms of iron, including ferrous, ferric, dissolved, suspended and complexed iron.

### SAFETY



The acidification of samples containing reactive materials may result in the release of toxic gases, such as cyanides or sulfides; the preparation of sample and the digestion should be done in a fume hood. Safety data sheets for all chemical reagents should be read and understood by all personnel using this method. Specifically, concentrated sulfuric acid is moderately toxic and corrosive to skin and mucous membranes. Use these reagents in a fume hood whenever possible. If eye or skin contact occurs, flush with large volumes of water. Always wear skin and eye protection when working with these reagents.

- Preheat the Hanna® Reactor HI839800 to 150 °C (302 °F). The optional HI740217 safety shield is strongly recommended. Do not use an oven or microwave; samples may leak and generate a corrosive and possibly explosive atmosphere.

### MEASUREMENT PROCEDURE

- Remove the cap from a HI96778V-0 Digestion Vial.

- Add 8 mL of sample to the vial, while keeping the vial at a 45-degree angle. Replace the cap and invert several times to mix.

**Warning:** The vials will become hot during mixing, use caution when handling.

- Remove the cap and add one packet of PERSULFATE/I Potassium Persulfate Reagent. Replace the cap. Shake the vial vigorously for 60 seconds.

- Insert the vial into the reactor and heat it for 30 minutes at 150 °C.

- At the end of the digestion place the vials carefully in the test tube rack and allow to cool to room temperature.

- Select the Iron Total (13 mm) method using the procedure described in the Factory Methods section.
- Insert the 13 mm vial adapter using the procedure described in the Cuvette & Vial Adapters section.

- Remove the cap from the vial and add 1 mL of HI96778A-0 Total Iron Reagent A, while keeping the vial at a 45-degree angle.
- Replace the cap. Invert several times to mix.

**Warning:** The vials will become hot during mixing, use caution when handling.

- Insert the vial into the adapter.

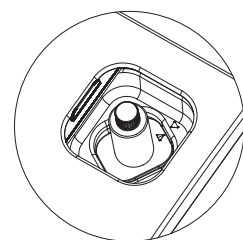
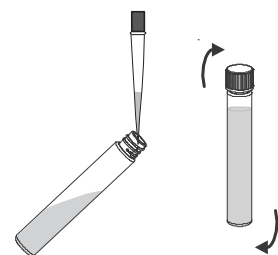
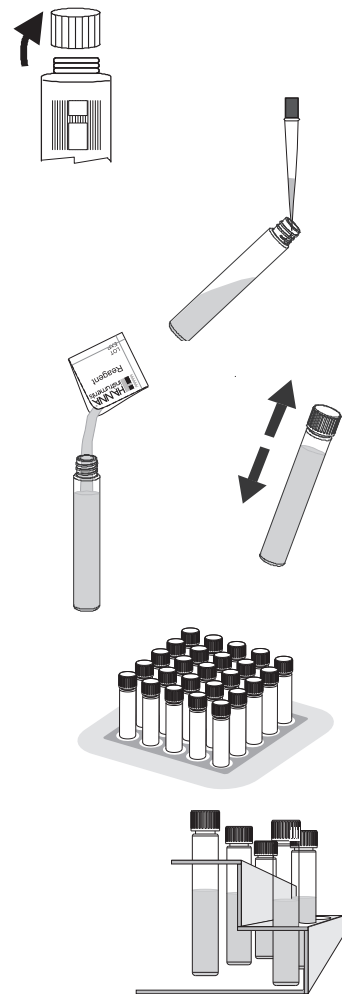

- Press **ZERO**. The display will show “-0-” when the meter is zeroed and ready for measurement.

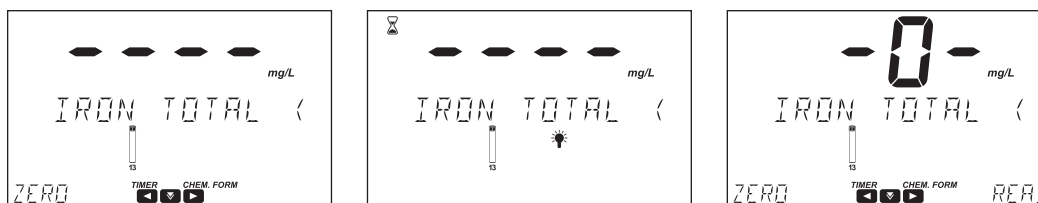

- Remove the vial from the meter.

*Note: The temperature of the vial must be between 18 and 22 °C before continuing.*

- Remove the cap and add one packet of **HI96778B-0** Total Iron Reagent B.

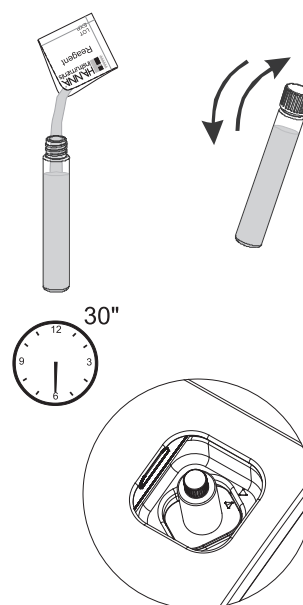

- Replace the cap. Shake gently for 30 seconds.

- Insert the vial into the adapter.

- Press the ◀ key to access the timer menu. Press **START** to start Timer 1, the display will show the countdown prior to measurement or wait 3 minutes.
- Press **READ** to start the reading. The instrument displays the results in **mg/L** of iron total (Fe).

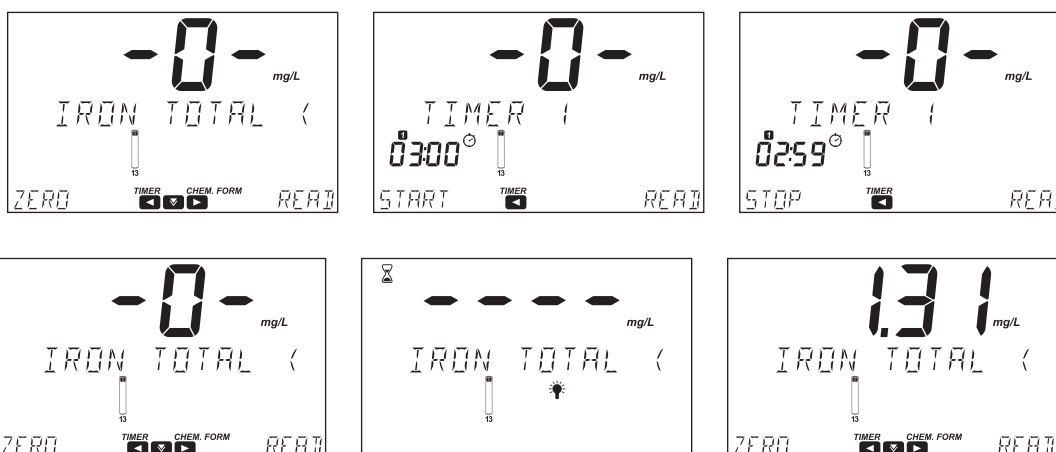

- Press the ▼ key to view the wavelength, method ID, date and time.

- Press the ► key to view the chemical formula.

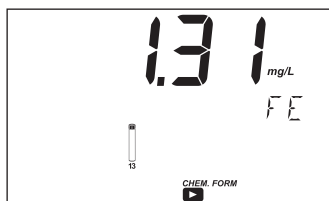

- Press the ► key to return to the measurement screen.

### INTERFERENCES

Interference may also be caused by:

- Chloride above 185000 mg/L
- Magnesium above 100000 mg/L  $\text{CaCO}_3$
- Calcium above 10000 mg/L  $\text{CaCO}_3$
- Molybdate Molybdenum above 50 mg/L
- High pH or highly buffered samples the pH must be less than 1 after adding the sample to digestion vial, after addition of [HI96778A-0](#) Total Iron Reagent A, the pH must be 3.8 to 5.5
- If turbidity forms after digestions, filter the sample
- Samples containing suspended solids need to be homogenized before digestion

## Magnesium

### SPECIFICATIONS

Range	0 to 150 mg/L (as Mg <sup>2+</sup> )
Resolution	1 mg/L
Accuracy	± 5 mg/L ± 3% of reading at 25 °C
Wavelength	466 nm
Cuvette type	22 mm diameter
Method	Adaptation of the Calmagite Method
Method ID	#048

### REQUIRED REAGENTS

Code	Description	Quantity
HI93752A-Mg	Magnesium Reagent A	1 mL
HI93752B-Mg	Magnesium Reagent B	9 mL

### REAGENT SETS

HI937520-01	Reagents for 50 tests
HI937520-03	Reagents for 150 tests

For other accessories see Accessories section.

### MEASUREMENT PROCEDURE

- Select the **Magnesium** method using the procedure described in the Factory Methods section.

- Add 1 mL of **HI93752A-Mg** Magnesium Reagent A to the cuvette using a 1 mL syringe and use the pipette to fill the cuvette up to the 10 mL mark with the **HI93752B-Mg** Magnesium Reagent B.

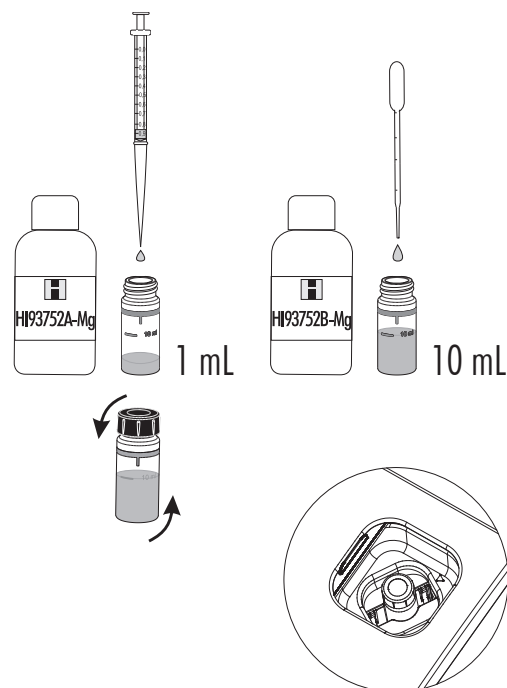

- Replace the plastic stopper and the cap. Invert several times to mix.

- Insert the cuvette into the holder and close the lid.

- Press **ZERO**. The display will show “-0-” when the meter is zeroed and ready for measurement.

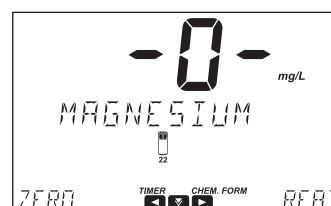
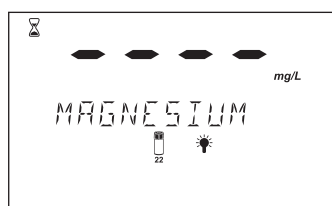
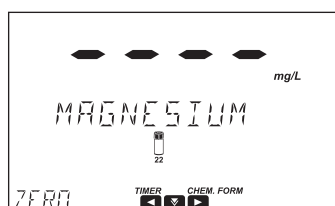

- Remove the cuvette.
- Add 0.5 mL of sample to the cuvette.
- Replace the plastic stopper and the cap. Invert several times to mix.
- Insert the cuvette into the holder and close the lid.

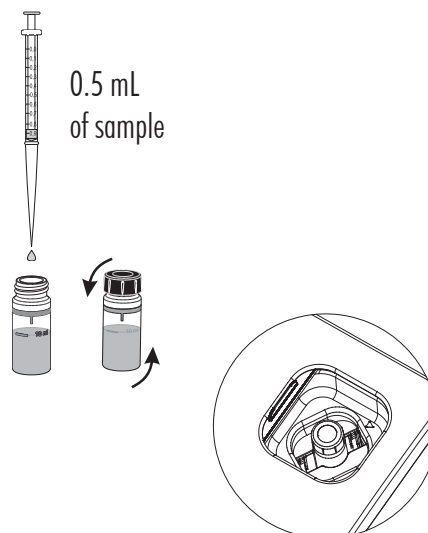

- Press the ◀ key to access the timer menu. Press **START** to start Timer 1, the display will show the countdown prior to measurement or wait 15 seconds.
- Press **READ** to start the reading. The instrument displays the results in mg/L of magnesium ( $Mg^{2+}$ ).

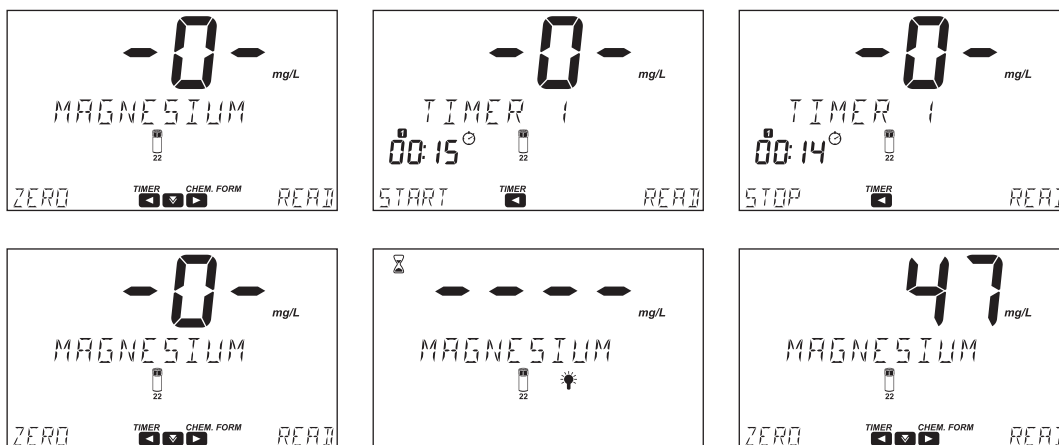

- Press the ▼ key to view the wavelength, method ID, date and time.
- Press the ▶ key to view the chemical formula.

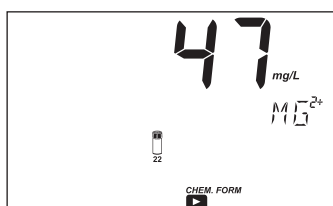

- Press the ▶ key to return to the measurement screen.

## INTERFERENCES

Interferences may be caused by:

- Acidity, Alkalinity (as  $CaCO_3$ ) above 1000 mg/L
- Calcium ( $Ca^{2+}$ ) above 200 mg/L
- Aluminum, Copper, Iron must be absent

## Manganese Low Range

### SPECIFICATIONS

Range	0 to 300 $\mu\text{g/L}$ (as Mn)
Resolution	1 $\mu\text{g/L}$
Accuracy	$\pm 7 \mu\text{g/L} \pm 3\%$ of reading at 25 °C
Wavelength	560 nm
Cuvette type	22 mm diameter
Method	Adaptation of the PAN Method
Method ID	#049

### REQUIRED REAGENTS

Code	Description	Quantity
HI93748A-0	Manganese Low Range Reagent A	2 packets
HI93748B-0	Manganese Low Range Reagent B	0.40 mL
HI93748C-0	Manganese Low Range Reagent C	2 mL
HI93703-1	Dispersing Agent	6 drops

### REAGENT SETS

HI93748-01	Reagents for 50 tests
HI93748-03	Reagents for 150 tests

For other accessories see Accessories section.

### MEASUREMENT PROCEDURE

- Select the [Manganese LR](#) method using the procedure described in the Factory Methods section.

- Fill one cuvette (#1) with 10 mL of deionized water (up to the mark).

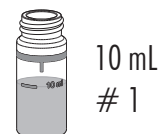

- Fill a second cuvette (#2) with 10 mL of sample (up to the mark).



- Add one packet of [HI93748A-0](#) Manganese Low Range Reagent A to each cuvette. Replace the plastic stoppers and the caps. Shake gently until completely dissolved.

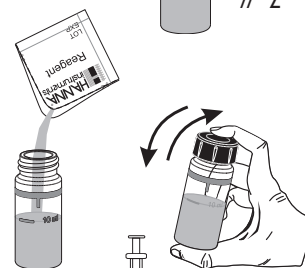

- Add 0.2 mL of the [HI93748B-0](#) Manganese Low Range Reagent B to each cuvette. Replace the plastic stoppers and the caps. Invert gently to mix for about 30 seconds.

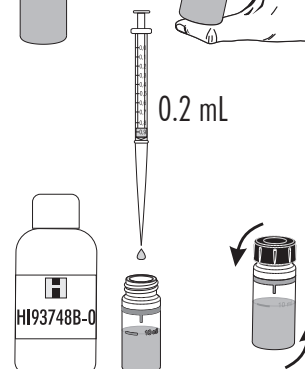

- Add 1 mL of the **HI93748C-0** Manganese Low Range Reagent C to each cuvette. Replace the plastic stoppers and the caps. Shake gently.

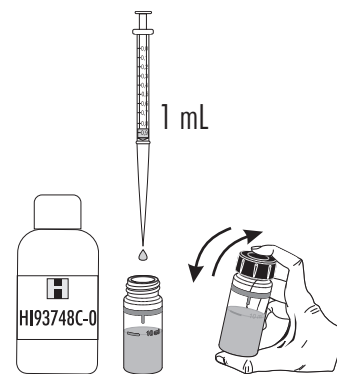

- Add 3 drops of **HI93703-51** Dispersing Agent to each cuvette. Replace the plastic stoppers and the caps. Invert gently to mix for about 30 seconds.

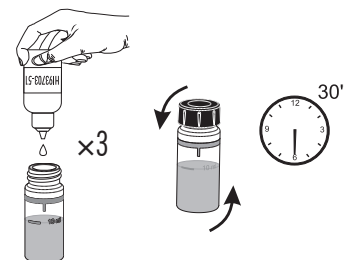

- Insert the first cuvette (#1) with the reacted deionized water into the holder and close the lid.

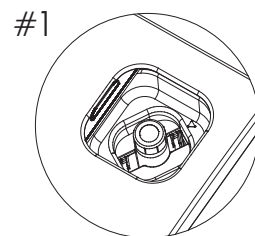

- Press the **◀** key to access the timer menu. Press **START** to start Timer 1, the display will show the countdown prior to the zero or wait 2 minutes.
- Press **ZERO**. The display will show “-0-” when the meter is zeroed and ready for measurement.

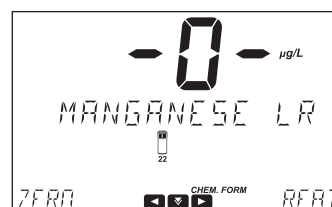
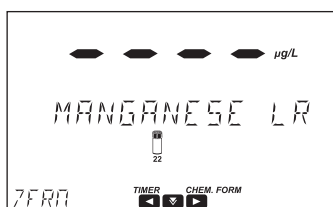
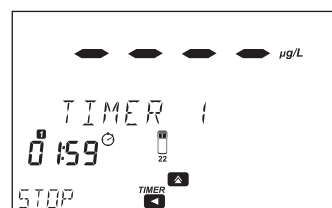
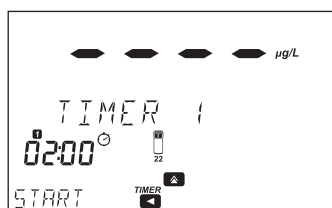
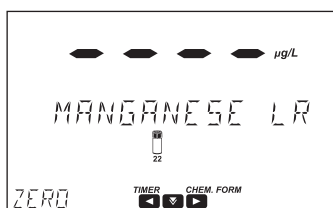

- Insert the second cuvette (#2) with the reacted sample into the holder and close the lid.

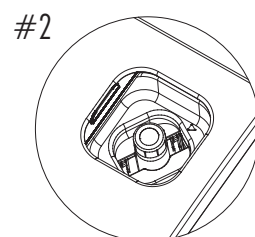



- Press **READ** to start the reading. The instrument displays the results in  $\mu\text{g/L}$  of manganese (Mn).

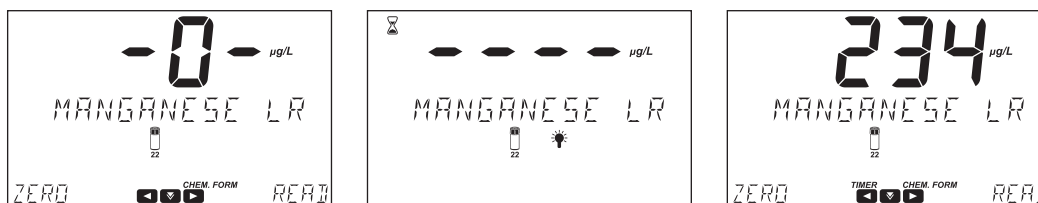

- Press the  $\nabla$  key to view the wavelength, method ID, date and time.
- Press the  $\blacktriangleright$  key to view the chemical formula.
- Press the  $\blacktriangle$  key to convert the results to  $\mu\text{g/L}$  of potassium permanganate ( $\text{KMnO}_4$ ) or permanganate ( $\text{MnO}_4^-$ ).

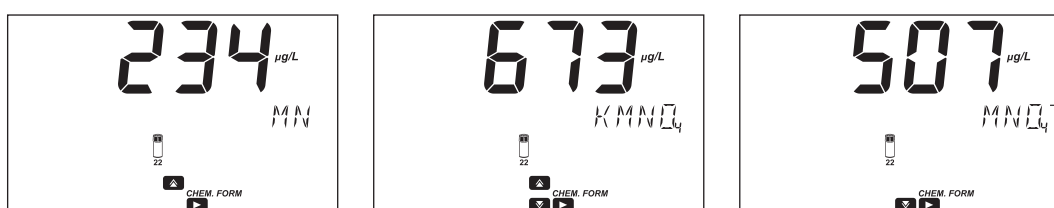

- Press the  $\blacktriangleright$  key to return to the measurement screen.

## INTERFERENCES

Interference may be caused by:

- Calcium above 200 mg/L  $\text{CaCO}_3$
- Magnesium above 100 mg/L  $\text{CaCO}_3$
- Copper above 50 mg/L
- Nickel above 40 mg/L
- Aluminum, Cobalt above 20 mg/L
- Zinc above 15 mg/L
- Cadmium, Iron above 10 mg/L
- Lead above 0.5 mg/L

## Manganese High Range

### SPECIFICATIONS

Range	0.0 to 20.0 mg/L (as Mn)
Resolution	0.1 mg/L
Accuracy	$\pm 0.2$ mg/L $\pm 3\%$ of reading at 25 °C
Wavelength	525 nm
Cuvette type	22 mm diameter
Method	Adaptation of the Standard Methods for the Examination of Water and Wastewater, 18 <sup>th</sup> Edition, Periodate Method
Method ID	#050

### REQUIRED REAGENTS

Code	Description	Quantity
HI93709A-0	Manganese High Range Reagent A	1 packet
HI93709B-0	Manganese High Range Reagent B	1 packet

### REAGENT SETS

HI93709-01	Reagents for 100 tests
HI93709-03	Reagents for 300 tests

For other accessories see Accessories section.

### MEASUREMENT PROCEDURE

- Select the **Manganese HR** method using the procedure described in the Factory Methods section.

- Fill the cuvette with 10 mL of unreacted sample (up to the mark). Replace the plastic stopper and the cap.



10 mL

- Insert the cuvette into the holder and close the lid.

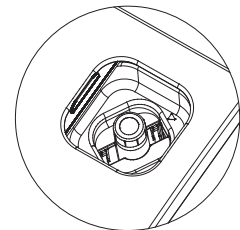

- Press **ZERO**. The display will show “-0-” when the meter is zeroed and ready for measurement.

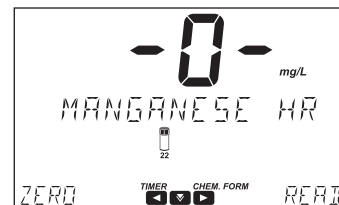
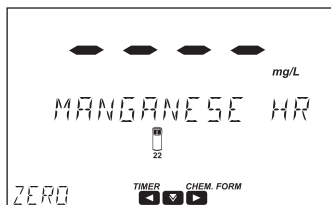

- Remove the cuvette.
- Add one packet of **HI93709A-0** Manganese High Range Reagent A. Replace the plastic stopper and the cap. Shake gently for 2 minutes to mix.

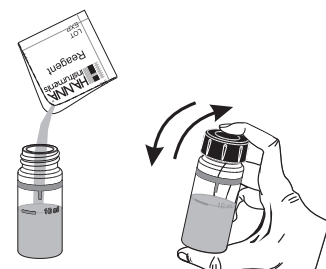

- Add one packet of **HI93709B-0** Manganese High Range Reagent B. Replace the plastic stopper and the cap. Shake gently for 2 minutes to mix.

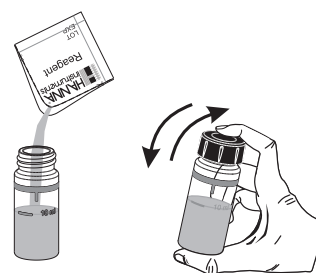

- Insert the cuvette into the holder and close the lid.

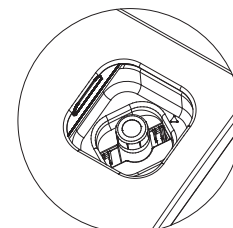

- Press the **◀** key to access the timer menu. Press **START** to start Timer 1, the display will show the countdown prior to measurement or wait 1 minute and 30 seconds.
- Press **READ** to start the reading. The instrument displays the results in **mg/L** of manganese (Mn).

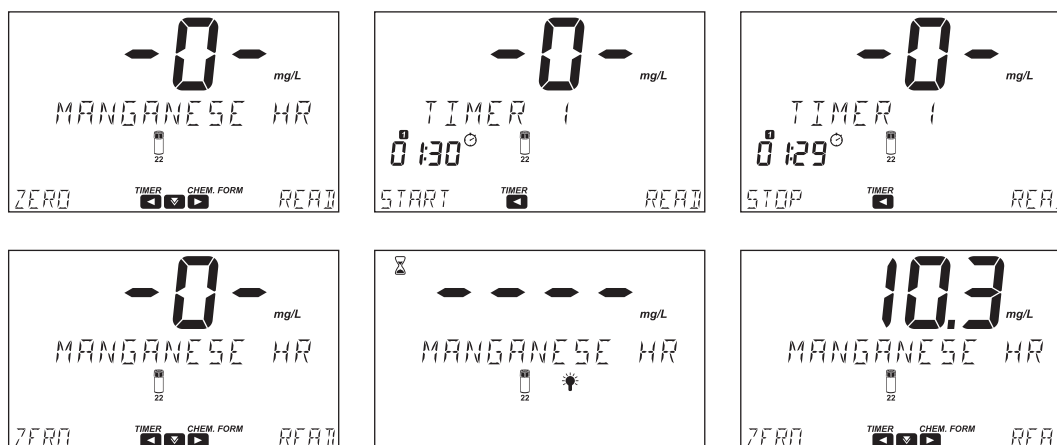

- Press the **▼** key to view the wavelength, method ID, date and time.
- Press the **▶** key to view the chemical formula.
- Press the **▲** key to convert the results in **mg/L** of potassium permanganate ( $\text{KMnO}_4$ ) or permanganate ( $\text{MnO}_4^-$ ).

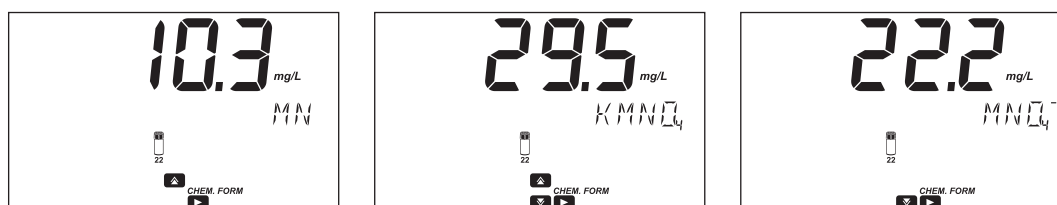

- Press the **▶** key to return to the measurement screen.

## INTERFERENCES

Interference may be caused by:

- Magnesium above 100000 mg/L
- Chloride above 70000 mg/L
- Calcium above 700 mg/L
- Iron above 5 mg/L

## Maple Syrup

### SPECIFICATIONS

Range	0.00 to 100.00 %T
Resolution	0.01 %T
Accuracy	±3% of reading at 25 °C
Wavelength	560 nm
Cuvette type	10 mm diameter
Method	Direct Measure
Method ID	#051

### REQUIRED REAGENT

Code	Description	Quantity
—	Glycerol	3 mL

### REAGENT SETS

HI93703-57	Glycerol (4 pcs.)	30 mL
------------	-------------------	-------

For other accessories see Accessories section.

### MEASUREMENT PROCEDURE

- Select the **Maple Syrup** method using the procedure described in the Factory Methods section.

- Use a syringe to fill the cuvette with glycerol, up to 5 mm (0.2") below the rim.

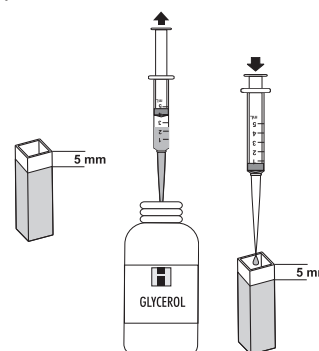

- Insert the 10 mm cuvette adapter using the procedure described in the Cuvette & Vial Adapters section.
- Insert the cuvette into the adapter and close the lid.

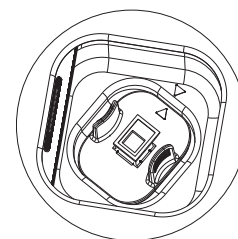

- Press **ZERO**. The display will show "-0-" when the meter is zeroed and ready for measurement.

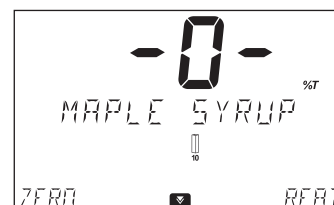
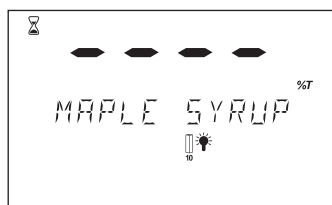
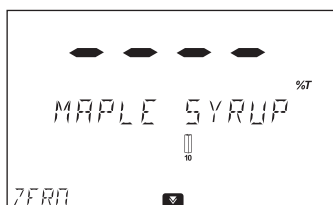

- Remove the blank cuvette.
- Use a syringe to add 4 mL of maple syrup to a clean cuvette, up to 5 mm (0.2") below the rim. This is the sample.

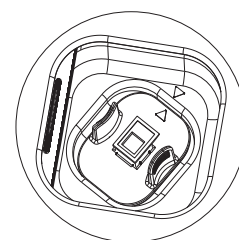
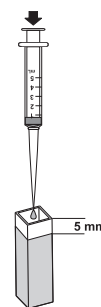

- Insert the sample cuvette into the adapter and close the lid.
- Press **READ** to start the reading. The instrument displays percent of light transmittance as compared to Glycerol Standard (fixed at one hundred percent).

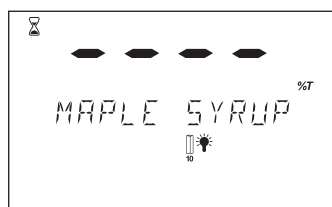
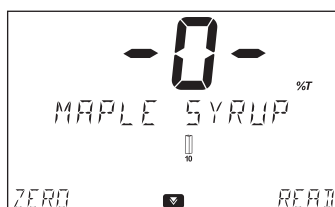

- Press the  key to view the wavelength, method ID, date and time.

### USDA Standards

Grade A Color Classes	Taste	Percent Light Transmittance
Grade A Golden	Delicate	$\geq 75$
Grade A Amber	Rich	50 to 74
Grade A Dark	Robust	25 to 49
Grade A Very Dark	Strong	$< 25$

### INTERFERENCES

Interference may be caused by:

- air bubbles or turbidity in the sample
- scratched or dirty cuvettes will also affect readings, always check clearness of cuvettes prior to use

## Molybdenum

### SPECIFICATIONS

Range	0.0 to 40.0 mg/L (as Mo <sup>6+</sup> )
Resolution	0.1 mg/L
Accuracy	±0.3 mg/L ±5% of reading at 25 °C
Wavelength	420 nm
Cuvette type	22 mm diameter
Method	Adaptation of the Mercaptoacetic Acid Method
Method ID	#052

### REQUIRED REAGENTS

Code	Description	Quantity
HI93730A-0	Molybdenum Reagent A	1 packet
HI93730B-0	Molybdenum Reagent B	1 packet
HI93730C-0	Molybdenum Reagent C	1 packet

### REAGENT SETS

HI93730-01	Reagents for 100 tests
HI93730-03	Reagents for 300 tests

For other accessories see Accessories section.

### MEASUREMENT PROCEDURE

- Select the **Molybdenum** method using the procedure described in the Factory Methods section.

- Fill the cuvette with 10 mL of unreacted sample (up to the mark).  
Replace the plastic stopper and the cap.



- Insert the cuvette into the holder and close the lid.

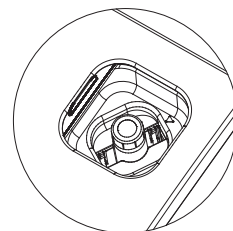

- Press **ZERO**. The display will show “-0-” when the meter is zeroed and ready for measurement.

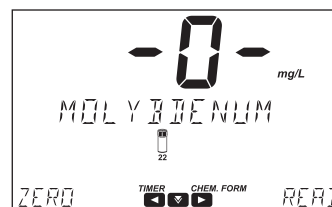
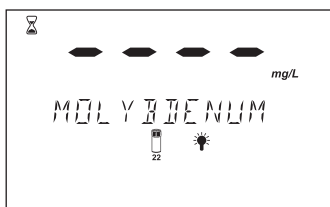
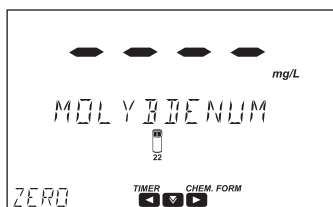

- Fill one graduated mixing cylinder up to the 25 mL mark with the sample.

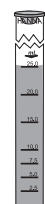

25 mL

- Add one packet of **HI93730A-0** Molybdenum Reagent A, close the graduated mixing cylinder. Replace the cap. Invert several times until completely dissolved.
- Add one packet of **HI93730B-0** Molybdenum Reagent B to the graduated mixing cylinder. Replace the cap. Invert several times until completely dissolved.
- Add one packet of **HI93730C-0** Molybdenum Reagent C to the graduated mixing cylinder. Replace the cap. Shake vigorously.

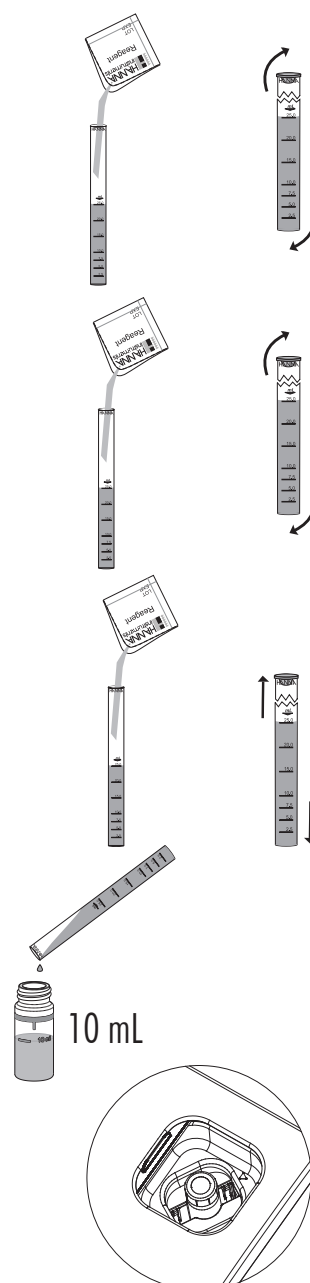

- Fill an empty cuvette with 10 mL of reacted sample (up to the mark). Replace the plastic stopper and the cap.
- Insert the cuvette into the holder and close the lid.
- Press the ◀ key to access the timer menu. Press **START** to start Timer 1, the display will show the countdown prior to measurement or wait 5 minutes.
- Press **READ** to start the reading. The instrument displays the results in mg/L of molybdenum ( $\text{Mo}^{6+}$ ).

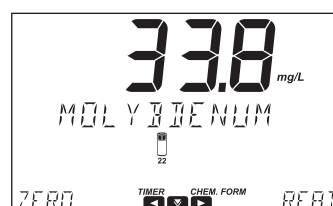
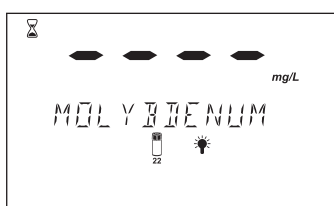
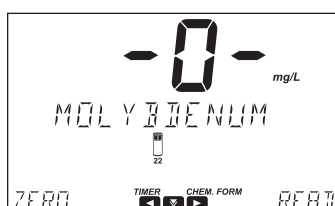
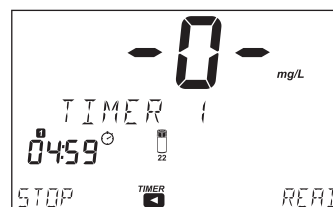
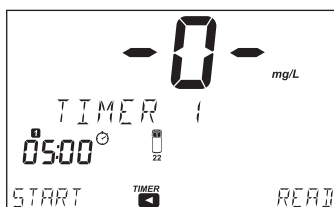
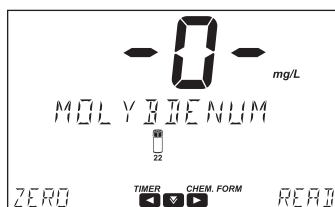

- Press the  $\nabla$  key to view the wavelength, method ID, date and time.
- Press the  $\blacktriangleright$  key to view the chemical formula.
- Press the  $\blacktriangle$  key to convert the results to mg/L of molybdate ( $\text{MoO}_4^{2-}$ ).

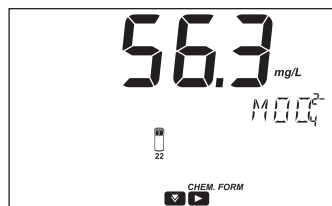
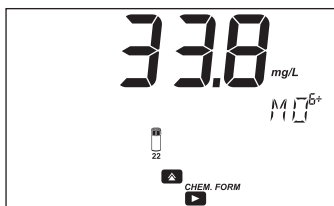

- Press the  $\blacktriangleright$  key to return to the measurement screen.

### INTERFERENCES

Interference may be caused by:

- Chromium above 1000 mg/L
- Sulfate above 200 mg/L
- Aluminum, Iron, Nickel above 50 mg/L
- Copper above 10 mg/L
- Nitrite must be absent
- Highly buffered samples or samples with extreme pH may exceed the buffering capacity of the reagents



## Nickel Low Range

### SPECIFICATIONS

Range	0.000 to 1.000 mg/L (as Ni)
Resolution	0.001 mg/L
Accuracy	$\pm 0.010$ mg/L $\pm 7\%$ of reading at 25 °C
Wavelength	565 nm
Cuvette type	16 mm diameter
Method	Adaptation of the PAN Method
Method ID	#053

### REQUIRED REAGENTS

Code	Description	Quantity
HI93740A-0	Nickel Low Range Reagent A	2 packets
HI93740B-0	Nickel Low Range Reagent B	2 mL
HI93740C-0	Nickel Low Range Reagent C	2 packets
HI93703-51	Dispersing Agent (optional reagent)	4-6 drops

### REAGENT SETS

HI93740-01	Reagents for 50 tests
HI93740-03	Reagents for 150 tests

For other accessories see Accessories section.

### MEASUREMENT PROCEDURE

- Select the **Nickel LR** method using the procedure described in the Factory Methods section.

**Note:** For best results samples should be between 20 and 24 °C.

- Fill one graduated beaker with 25 mL of deionized water (blank) and another one with 25 mL of sample.
- Add one packet of **HI93740A-0** Nickel Low Range Reagent A to each beaker. Swirl gently until the reagent is dissolved.

**Note:** If sample contains iron ( $Fe^{3+}$ ), it is important that all powder is dissolved before continuing.

- Add 1 mL of **HI93740B-0** Nickel Low Range Reagent B to each beaker. Swirl to mix.

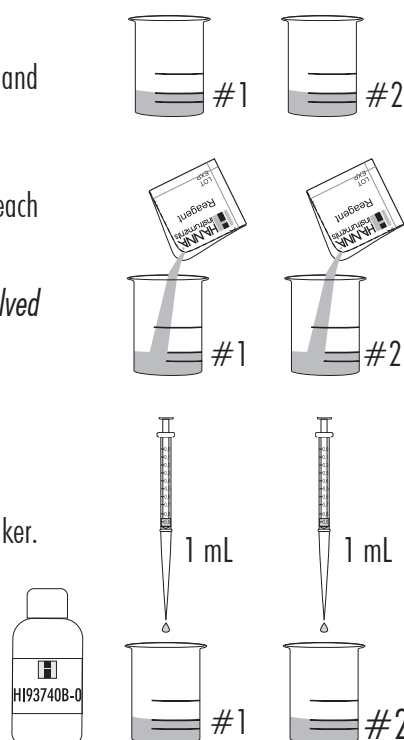

- Press the ◀ key to access the timer menu. Press **START** to start Timer 1, the display will show the countdown or wait 15 minutes.

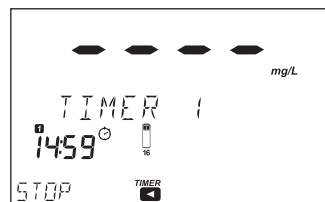
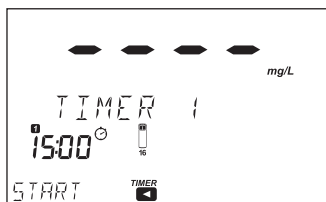
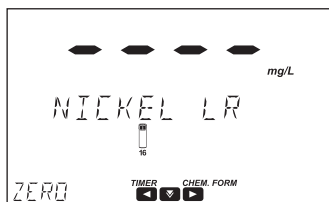

- Add one packet of **HI93740C-0** Nickel Low Range Reagent C to each beaker. Swirl to mix until completely dissolved.

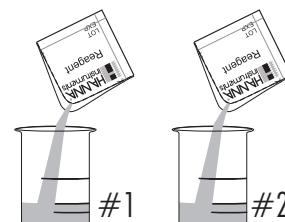

- Insert the 16 mm cuvette adapter using the procedure described in the Cuvette & Vial Adapters section.

- Fill one cuvette (#1) with 10 mL of the blank (up to the mark).



- Insert the cuvette into the adapter and close the lid.

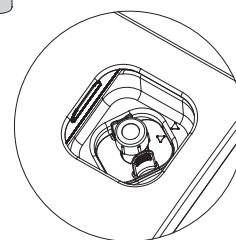

- Press **ZERO**. The display will show "-0-" when the meter is zeroed and ready for measurement.

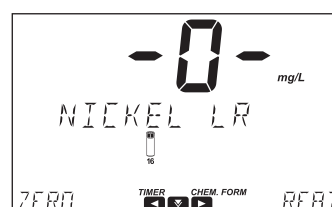
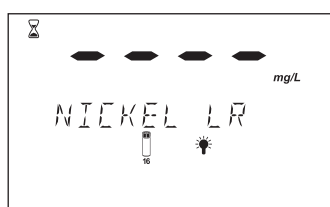
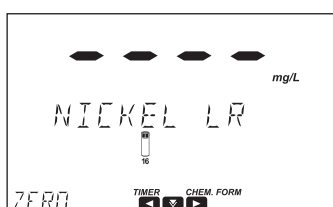

- Fill a second cuvette (#2) with 10 mL of the reacted sample.



- Insert the second cuvette into the adapter and close the lid.

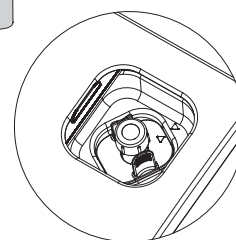

- Press **READ** to start the reading. The instrument displays the results in mg/L of nickel (Ni).

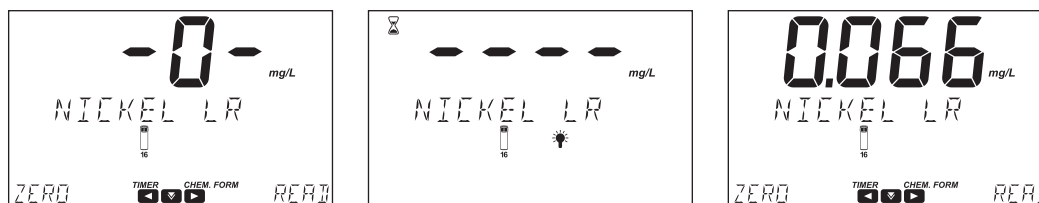

- Press the **▼** key to view the wavelength, method ID, date and time.
- Press the **▶** key to view the chemical formula.

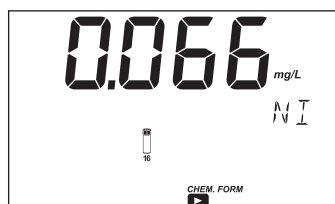

- Press the **▶** key to return to the measurement screen.

**Note:** A temperature above 30 °C may cause turbidity. In this case add 2-3 drops of [HI93703-51](#) Dispersing Agent to each cuvette and swirl until turbidity is removed before zeroing the meter and reading the sample.

## INTERFERENCES

Interference may be caused by:

- Chloride above 8000 mg/L
- Sodium above 5000 mg/L
- Calcium above 1000 mg/L CaCO<sub>3</sub>
- Potassium above 500 mg/L
- Magnesium above 400 mg/L
- Molybdenum above 60 mg/L
- Chromium(VI) above 40 mg/L
- Aluminum above 32 mg/L
- Zinc above 30 mg/L
- Manganese above 25 mg/L
- Cadmium, Chromium(III), Fluoride, Lead above 20 mg/L
- Copper above 15 mg/L
- Iron (Ferric) above 10 mg/L
- Cobalt, Iron (Ferrous) must not be present

## Nickel High Range

### SPECIFICATIONS

Range	0.00 to 7.00 ppt (as Ni)
Resolution	0.01 ppt
Accuracy	$\pm 0.07$ ppt $\pm 4\%$ of reading at 25 °C
Wavelength	575 nm
Cuvette type	22 mm diameter
Method	Adaptation of the Photometric Method
Method ID	#054

### REQUIRED REAGENTS

Code	Description	Quantity
HI93726-0	Nickel High Range Reagent	1 packet

### REAGENT SETS

HI93726-01 Reagents for 100 tests

HI93726-03 Reagents for 300 tests

For other accessories see Accessories section.

### MEASUREMENT PROCEDURE

- Select the **Nickel HR** method using the procedure described in the Factory Methods section.

- Fill the cuvette with 10 mL of unreacted sample (up to the mark). Replace the plastic stopper and the cap.

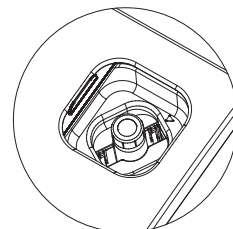

- Insert the cuvette into the holder and close the lid.

- Press **ZERO**. The display will show “-0-” when the meter is zeroed and ready for measurement.

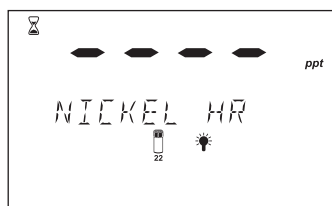
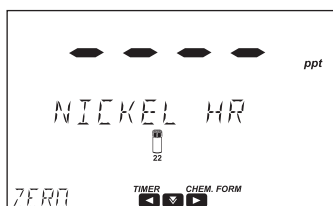

- Remove the cuvette and add one packet of **HI93726-0** Nickel High Range Reagent. Replace the plastic stopper and the cap. Shake gently until completely dissolved.

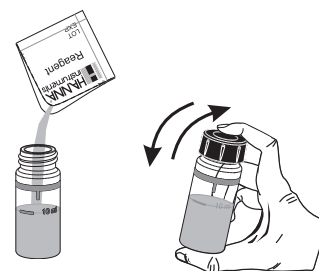

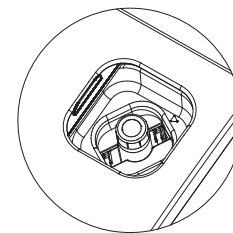

- Insert the cuvette into the holder and close the lid.
- Press the ◀ key to access the timer menu. Press **START** to start Timer 1, the display will show the countdown prior to measurement or wait 1 minute.
- Press **READ** to start the reading. The instrument displays the results in mg/L of nickel (Ni).

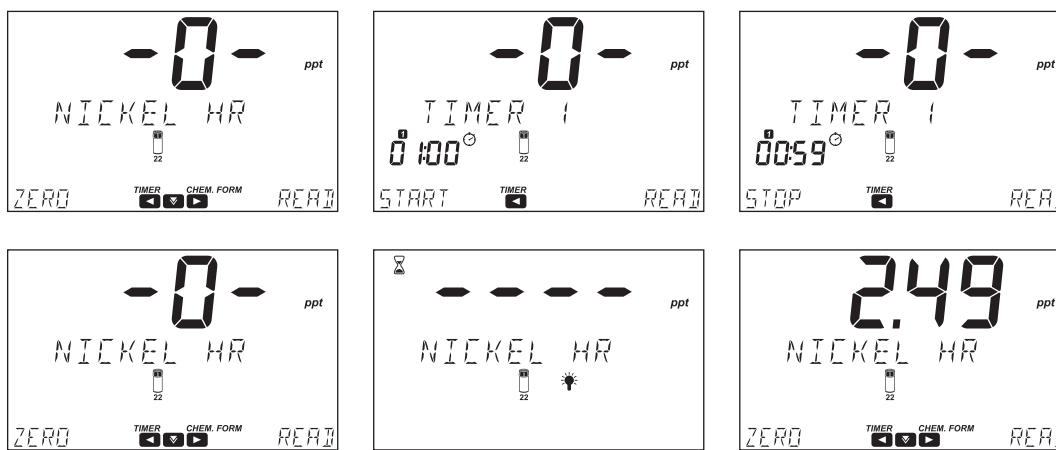

- Press the ▼ key to view the wavelength, method ID, date and time.
- Press the ▶ key to view the chemical formula.

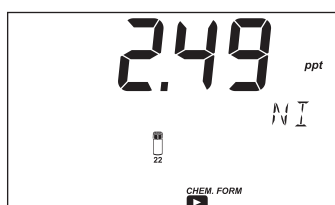

- Press the ▶ key to return to the measurement screen.

## INTERFERENCES

Interference may be caused by

- Copper

## Nitrate

### SPECIFICATIONS

Range	0.0 to 30.0 mg/L (as NO <sub>3</sub> <sup>-</sup> -N)
Resolution	0.1 mg/L
Accuracy	±0.5 mg/L ± 10% of reading at 25 °C
Wavelength	525 nm
Cuvette type	22 mm diameter
Method	Adaptation of the Cadmium Reduction Method
Method ID	#055

### REQUIRED REAGENTS

Code	Description	Quantity
HI93728-0	Nitrate Reagent	1 packet

### REAGENT SETS

HI93728-01 Reagents for 100 tests

HI93728-03 Reagents for 300 tests

For other accessories see Accessories section.

### MEASUREMENT PROCEDURE

- Select the **Nitrate** method using the procedure described in the Factory Methods section.

- Fill the cuvette with 10 mL of sample, (up to the mark).  
Replace the plastic stopper and the cap.



- Insert the cuvette into the holder and close the lid.

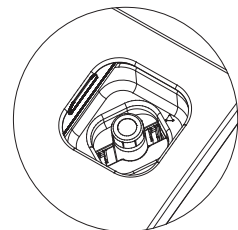

- Press **ZERO**. The display will show “-0-” when the meter is zeroed and ready for measurement.

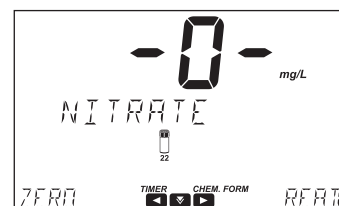
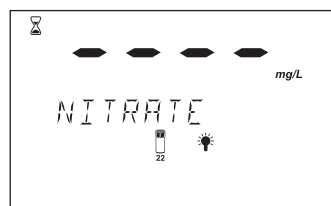
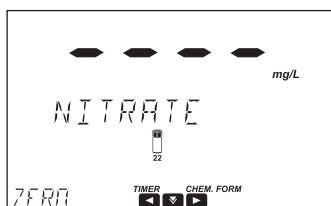

- Remove the cuvette and add one packet of **HI93728-0** Nitrate Reagent.



- Replace the plastic stopper and the cap. Shake vigorously up and down for exactly 10 seconds. Continue to mix by inverting the cuvette gently for 50 seconds, while taking care not to induce air bubbles. Powder will not completely dissolve. Time and method of shaking could sensitively affect the measurement.

**Note:** The method is technique-sensitive. See procedure described in the *Cuvette Preparation* section for proper mixing technique.

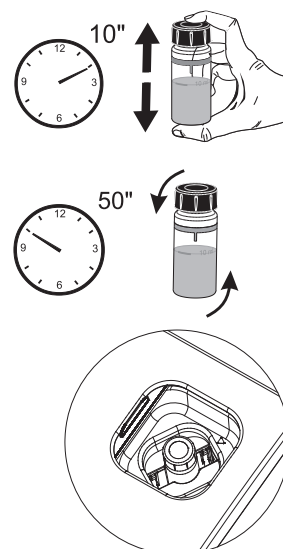

- Insert the cuvette into the holder and close the lid.
- Press the ◀ key to access the timer menu. Press **START** to start Timer 1, the display will show the countdown prior to measurement or wait 4 minutes and 30 seconds.
- Press **READ** to start the reading. The instrument displays the results in mg/L of nitrate-nitrogen ( $\text{NO}_3^- \text{-N}$ ).

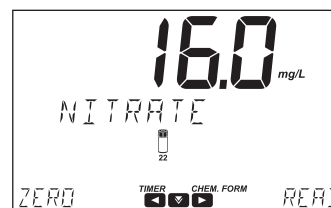
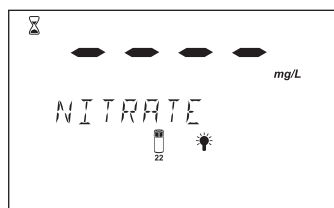
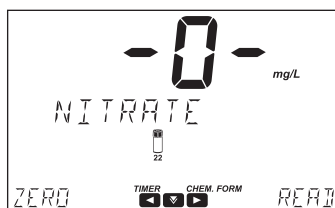
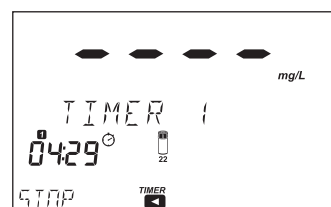
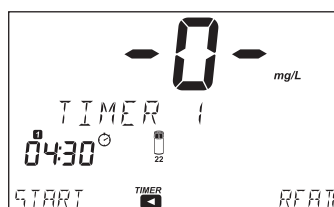
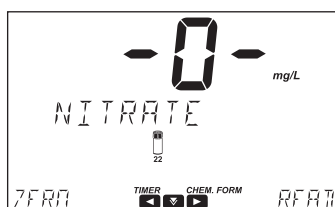

- Press the ▼ key to view the wavelength, method ID, date and time.
- Press the ▶ key to view the chemical formula.
- Press the ▲ key to convert the results to mg/L of nitrate ( $\text{NO}_3^-$ ).

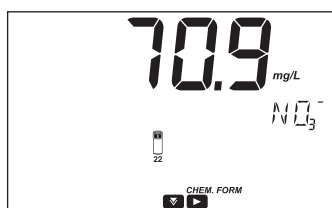
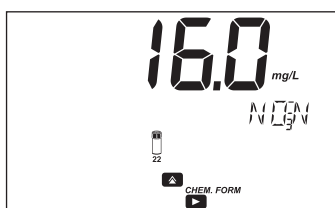

- Press the ▶ key to return to the measurement screen.

## INTERFERENCES

Interference may be caused by:

- Ammonia and amines, as urea and primary aliphatic amines
- Chloride above 100 mg/L
- Chlorine above 2 mg/L
- Copper, Iron(III), Strong oxidizing and reducing substances
- Sulfide must be absent

## Nitrate Chromotropic Acid (13 mm Vial)

### SPECIFICATIONS

Range	0.0 to 30.0 mg/L (as NO <sub>3</sub> <sup>-</sup> -N)
Resolution	0.1 mg/L
Accuracy	±1.0 mg/L or ±3% of reading at 25 °C, whichever is greater
Wavelength	410 nm
Cuvette type	13 mm diameter
Method	Chromotropic Acid Method
Method ID	#056

### REQUIRED REAGENTS

Code	Description	Quantity
HI93766V-0*	Nitrate Reagent Vial	1 vial
HI93766-0	Nitrate Reagent	1 packet

\* Reagent vial identification: N, white label

### REAGENT SETS

HI93766-50 Reagents for 50 tests

For other accessories see Accessories section.

**Note:** Store the unused vials in their packaging in a cool and dark place.

### MEASUREMENT PROCEDURE



Before using the reagent kit carefully read all the instructions and the Safety Data Sheets (SDS). Pay particular attention to all warnings, cautions, and notes. Failure to do so may result in serious injury to the operator.

- Select the **Nitrate (13 mm)** method using the procedure described in the Factory Methods section.
- Insert the 13 mm vial adapter using the procedure described in the Cuvette & Vial Adapters section.
- Remove the cap from a HI93766V-0 Nitrate Reagent Vial.
- Add 1.0 mL of sample to the vial, while keeping the vial at a 45-degree angle.
- Replace the cap and invert the vial 10 times. This is the blank.

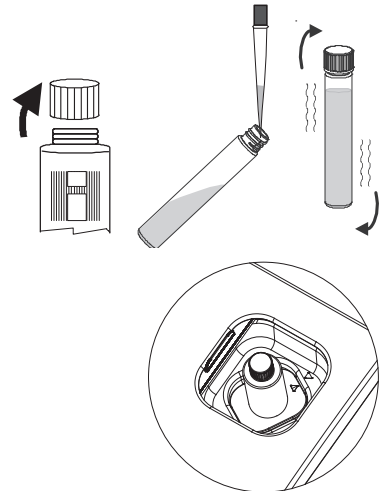

**Warning:** The vial will become hot during mixing. Use caution when handling.

**Note:** The method is technique sensitive. See procedure described in the Cuvette Preparation section for proper mixing technique.

- Insert the vial into the adapter.
- Press **ZERO**. The display will show “-0-” when the meter is zeroed and ready for measurement.

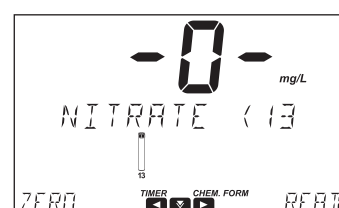
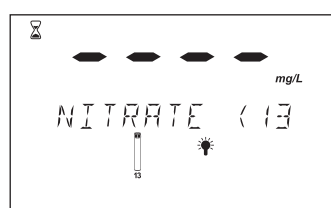
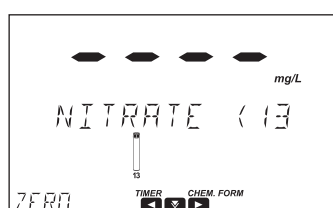



- Remove the vial.
- Add one packet of HI93766-0 Nitrate Reagent.
- Replace the cap and invert the vial 10 times. This is the reacted sample.

**Note:** The method is technique sensitive. See procedure described in the Cuvette Preparation section for proper mixing technique.

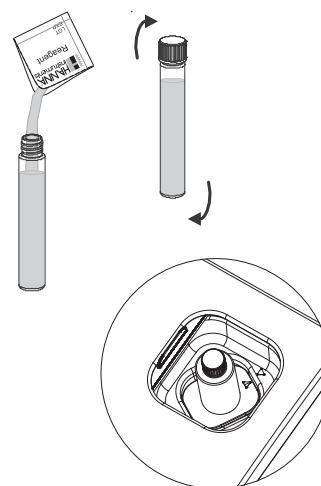

- Insert the vial into the adapter.
- Press the ◀ key to access the timer menu. Press **START** to start Timer 1, the display will show the countdown prior to measurement or wait 5 minutes.
- Press **READ** to start the reading. The instrument displays the results in mg/L of nitrate-nitrogen ( $\text{NO}_3^- \text{-N}$ ).

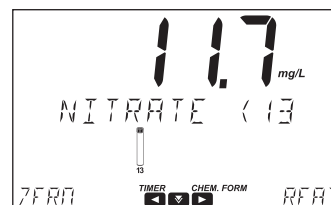
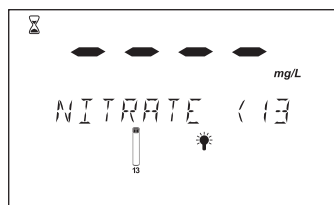
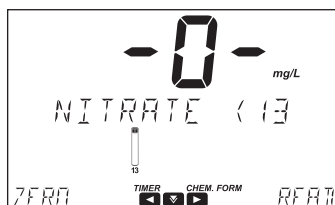
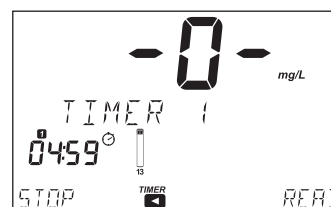
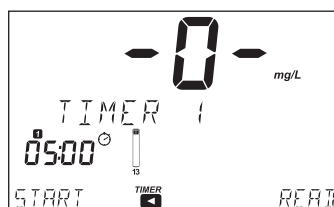
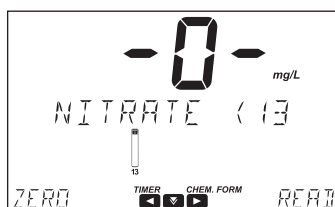

- Press the ▼ key to view the wavelength, method ID, date and time.
- Press the ► key to view the chemical formula.
- Press the ▲ key to convert the results to mg/L of nitrate ( $\text{NO}_3^-$ ).

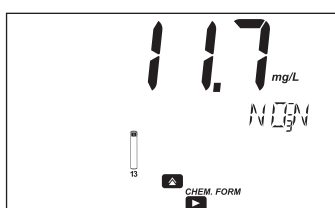

- Press the ► key to return to the measurement screen.

## INTERFERENCES

Interference may be caused by:

- Chloride ( $\text{Cl}^-$ ) above 1000 mg/L
- Nitrite ( $\text{NO}_2^-$ ) above 50 mg/L
- Barium ( $\text{Ba}^{2+}$ ) above 1 mg/L
- Samples containing up to 100 mg/L nitrite may be measured after the following treatment: add 400 mg of urea to 10 mL of sample, mix until completely dissolved, then proceed with the usual measurement procedure

## Nitrite, Marine Ultra Low Range

### SPECIFICATIONS

Range	0 to 200 $\mu\text{g/L}$ (as $\text{NO}_2^-$ -N)
Resolution	1 $\mu\text{g/L}$
Accuracy	$\pm 8 \mu\text{g/L} \pm 4\%$ of reading at 25 °C
Wavelength	480 nm
Cuvette type	22 mm diameter
Method	Adaptation of the EPA Diazotization Method 354.1
Method ID	#057

### REQUIRED REAGENTS

Code	Description	Quantity
HI764-25	Nitrite Ultra Low Range Marine Reagent	1 packet

### REAGENT SETS

HI764-25 Reagents for 25 tests  
For other accessories see Accessories section.

### MEASUREMENT PROCEDURE

- Select the **Nitrite Marine ULR** method using the procedure described in the Factory Methods section.

- Fill the cuvette with 10 mL of unreacted sample (up to the mark). Replace the plastic stopper and the cap.

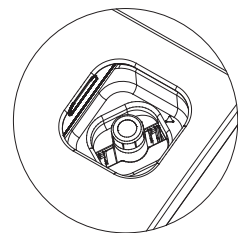

- Insert the cuvette into the holder and close the lid.

- Press **ZERO**. The display will show “-0-” when the meter is zeroed and ready for measurement.

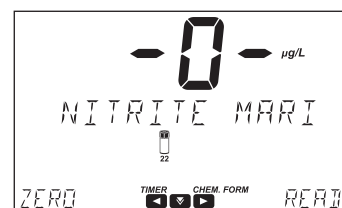
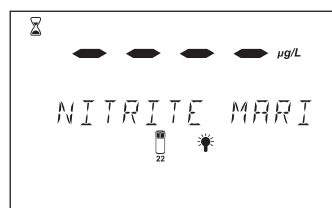
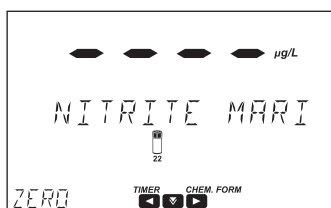

- Remove the cuvette.
- Add one packet of **HI764-25** Nitrite Ultra Low Range Marine Reagent. Replace the plastic stopper and the cap. Shake gently for about 15 seconds.

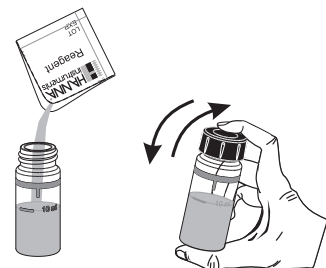

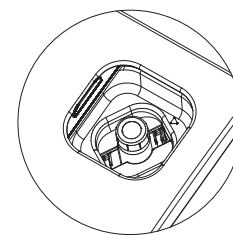

- Insert the cuvette into the holder and close the lid.
- Press the ◀ key to access the timer menu. Press **START** to start Timer 1, the display will show the countdown prior to measurement or wait 15 minutes.
- Press **READ** to start the reading. The instrument displays the results in  $\mu\text{g/L}$  of nitrite-nitrogen ( $\text{NO}_2^- - \text{N}$ ).

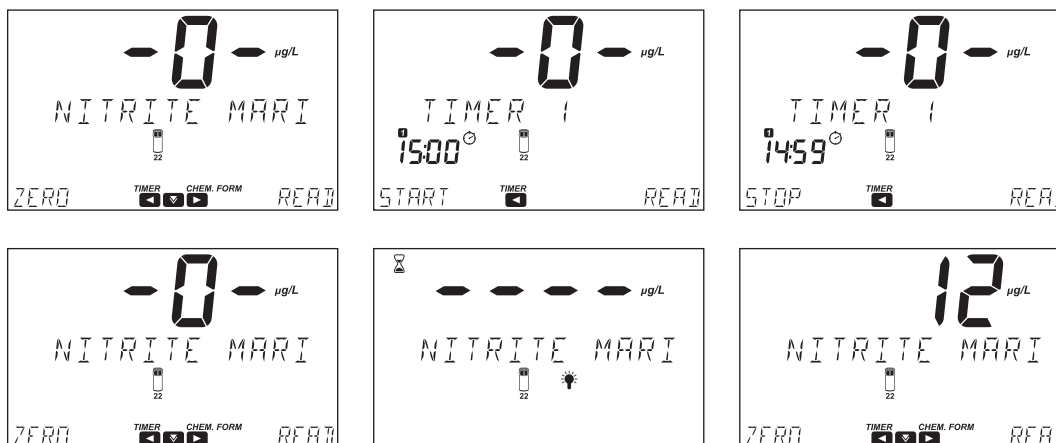

- Press the ▼ key to view the wavelength, method ID, date and time.
- Press the ▶ key to view the chemical formula.
- Press the ▲ key to convert the results to  $\mu\text{g/L}$  of nitrite ( $\text{NO}_2^-$ ) or sodium nitrite ( $\text{NaNO}_2$ ).

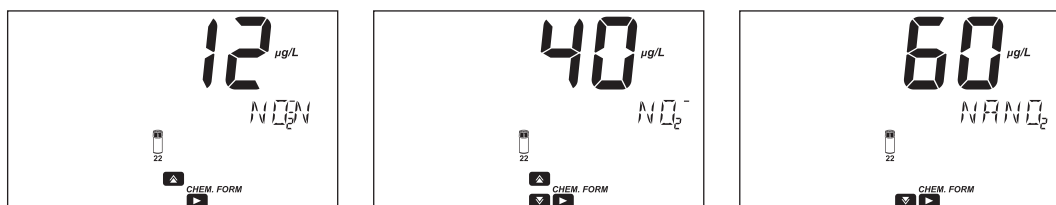

- Press the ▶ key to return to the measurement screen.

## INTERFERENCES

Interference may be caused by:

- Antimonious, Auric, Bismuth, Chloroplatinate ions, Cupric, Iron (Ferric), Iron (Ferrous), Lead, Mercurous, Silver, Strong reducing or oxidizing agents
- Nitrate above 100 mg/L could yield falsely high readings

## Nitrite Low Range

### SPECIFICATIONS

Range	0 to 600 $\mu\text{g/L}$ (as $\text{NO}_2^- - \text{N}$ )
Resolution	1 $\mu\text{g/L}$
Accuracy	$\pm 20 \mu\text{g/L} \pm 4\%$ of reading at 25 °C
Wavelength	480 nm
Cuvette type	22 mm diameter
Method	Adaptation of the EPA Diazotization Method 354.1
Method ID	#058

### REQUIRED REAGENTS

Code	Description	Quantity
HI93707-0	Nitrite Low Range Reagent	1 packet

### REAGENT SETS

HI93707-01 Reagents for 100 tests

HI93707-03 Reagents for 300 tests

For other accessories see Accessories section.

### MEASUREMENT PROCEDURE

- Select the **Nitrite LR** method using the procedure described in the Factory Methods section.

- Fill the cuvette with 10 mL of unreacted sample (up to the mark). Replace the plastic stopper and the cap.

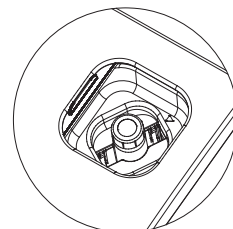

- Insert the cuvette into the holder and close the lid.
- Press **ZERO**. The display will show “-0-” when the meter is zeroed and ready for measurement.

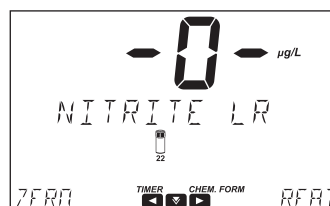
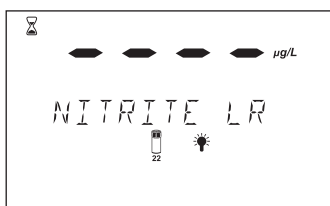
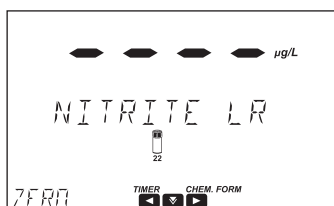

- Remove the cuvette.
- Add one packet of **HI93707-0** Nitrite Low Range Reagent. Replace the plastic stopper and the cap. Shake gently for about 15 seconds.

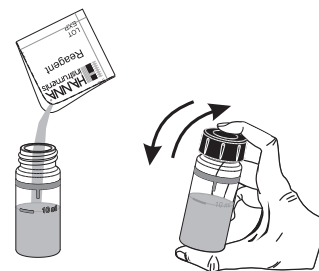

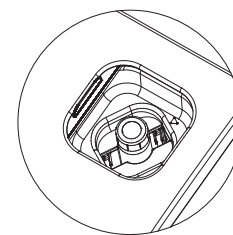

- Insert the cuvette into the holder and close the lid.
- Press the ◀ key to access the timer menu. Press **START** to start Timer 1, the display will show the countdown prior to measurement or wait 15 minutes.
- Press **READ** to start the reading. The instrument displays the results in  $\mu\text{g/L}$  of nitrite-nitrogen ( $\text{NO}_2^- - \text{N}$ ).

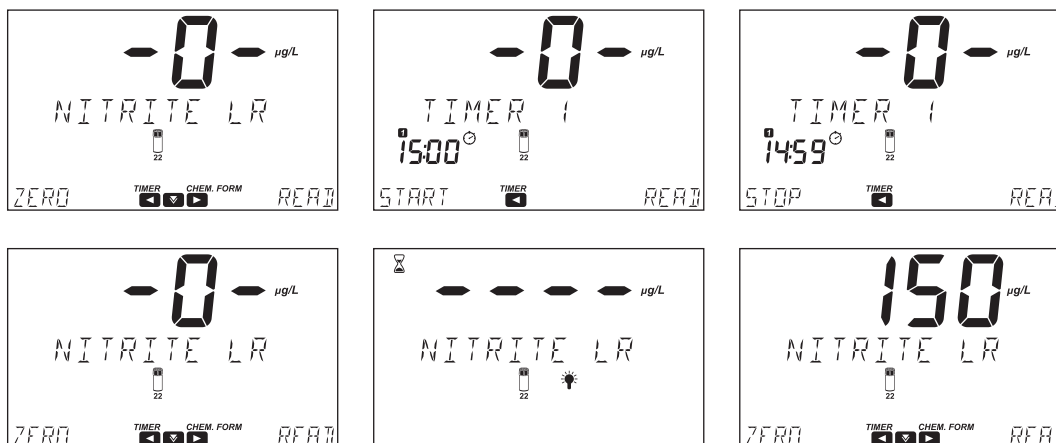

- Press the ▼ key to view the wavelength, method ID, date and time.
- Press the ▶ key to view the chemical formula.
- Press the ▲ key to convert the results to  $\mu\text{g/L}$  of nitrite ( $\text{NO}_2^-$ ) or sodium nitrite ( $\text{NaNO}_2$ ).



- Press the ▶ key to return to the measurement screen.

## INTERFERENCES

Interference may be caused by:

- Antimonious, Auric, Bismuth, Chloroplatinate ions, Cupric, Iron (Ferric), Iron (Ferrous), Lead, Mercurous, Silver, Strong reducing or oxidizing agents
- Nitrate above 100 mg/L could yield falsely high readings

## Nitrite Low Range (13 mm Vial)

### SPECIFICATIONS

Range	0 to 600 $\mu\text{g/L}$ (as $\text{NO}_2\text{-N}$ )
Resolution	1 $\mu\text{g/L}$
Accuracy	$\pm 10 \mu\text{g/L} \pm 3\%$ of reading at 25°C, whichever is greater
Wavelength	525 nm
Cuvette type	13 mm diameter
Method	Adaptation of the Standard Method for the Examination of Water and Wastewater, 23 <sup>rd</sup> Edition, 4500B Diazotization Method, Nitrogen Nitrite
Method ID	#091

### REQUIRED REAGENT

Code	Description	Quantity
HI96783V-0*	Nitrite Low Range Reagent Vial	1 vial
HI96783-0	Nitrite Low Range Reagent for Vial	1 packet

\*Reagent vial identification:  $\text{NO}_2\text{LR}$ , green label

### REAGENT SETS

HI96783-25 Reagents for 25 tests

For other accessories see Accessories section.

*Note: Store the unused vials in their packaging in a cool and dark place.*

### PRINCIPLE

Nitrite is determined through formation of a reddish purple azo dye produced in acidic solution by coupling diazotized sulfanilamide with aromatic amines.

### APPLICATION

Wastewater, drinking water, surface water, mineral water, groundwater

### SIGNIFICANCE & USE

Nitrite is an intermediate oxidation state of nitrogen, both in the oxidation of ammonia to nitrate and in the reduction of nitrate. Such oxidation and reduction may occur in wastewater treatment plants, water distribution systems and natural waters. Nitrite can enter a water supply system through its use as a corrosion inhibitor in industrial process water. Nitrite changes the normal form of hemoglobin, which carries oxygen through blood to the rest of the body, into a form called methemoglobin that cannot carry oxygen.

### MEASUREMENT PROCEDURE

- Select the **Nitrite LR (13 mm)** method using the procedure described in the Factory Methods section.
- Insert the 13 mm vial adapter using the procedure described in the Cuvette & Vial Adapters section.
- Remove the cap from a **HI96783V-0** Nitrite Low Range Reagent Vial.



- Add 4 mL of sample to the vial, while keeping the vial at a 45-degree angle.

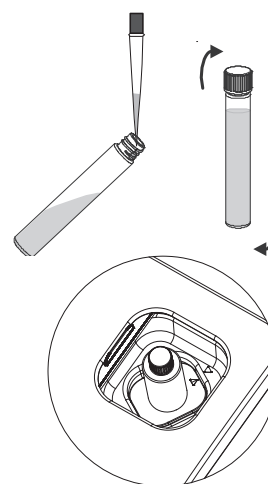

- Replace the cap. Invert several times to mix. This is the blank.

- Insert the vial into the adapter.

- Press **ZERO**. The display will show “-0-” when the meter is zeroed and ready for measurement.

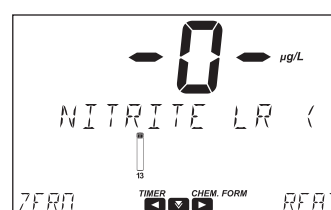
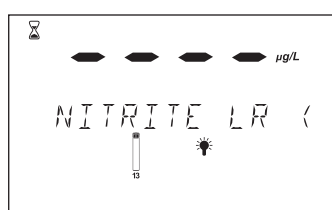
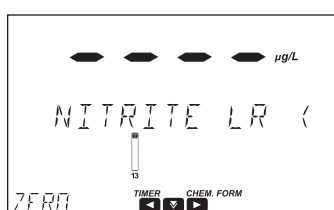

- Remove the vial.

- Remove the cap. Add one packet of **HI96783-0** Nitrite Low Range Reagent for Vial.

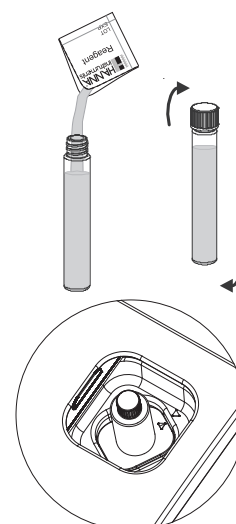





- Replace the cap. Invert for 30 seconds to mix.

- Insert the vial into the adapter.

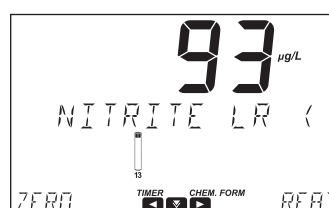
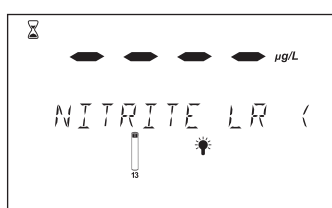
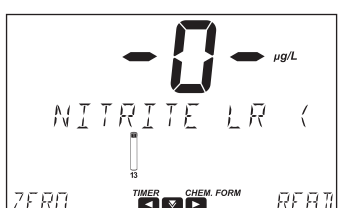
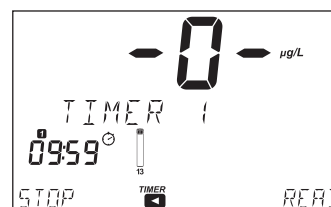
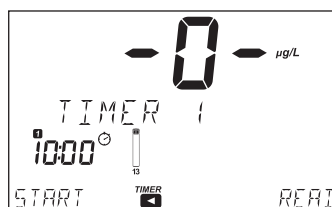
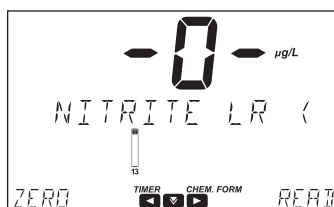
- Press the ◀ key to access the timer menu. Press **START** to start Timer 1, the display will show the countdown prior to measurement or wait 10 minutes.

- Press **READ** to start the reading. The instrument displays the results in  $\mu\text{g/L}$  of nitrite-nitrogen ( $\text{NO}_2^- \text{-N}$ ).



- Press the  key to view the wavelength, method ID, date and time.
- Press the  key to view the chemical formula.
- Press the  key to convert the results to  $\mu\text{g/L}$  of nitrite ( $\text{NO}_2^-$ ) or sodium nitrite ( $\text{NaNO}_2$ ).



- Press the  key to return to the measurement screen.

### INTERFERENCES

The pH of the sample must be between 2.0 and 3.0 after the addition of the reagents.

Interference may be caused by:

- Chlorine, Sodium, Sulfate above 2000 mg/L
- Ammonium, Calcium, Nitrate, Phosphate, Potassium above 1000 mg/L
- Magnesium above 500 mg/L
- Copper above 100 mg/L
- Manganese, Zinc above 25 mg/L
- Nickel above 10 mg/L
- Iron above 5 mg/L



## Nitrite Medium Range (13 mm Vial)

### SPECIFICATIONS

Range	0.00 to 6.00 mg/L (as NO <sub>2</sub> -N)
Resolution	0.01 mg/L
Accuracy	±0.10 mg/L ± 3% of reading at 25°C
Wavelength	525 nm
Cuvette type	13 mm diameter
Method	Adaptation of the Standard Method for the Examination of Water and Wastewater, 23 <sup>rd</sup> Edition, 4500B Diazotization Method, Nitrogen Nitrite
Method ID	#092

### REQUIRED REAGENT

Code	Description	Quantity
<a href="#">HI96784V-0*</a>	Nitrite Medium Range Reagent Vial	1 vial
<a href="#">HI96784-0</a>	Nitrite Medium Range Reagent for Vial	1 packet

\*Reagent vial identification: NO<sub>2</sub>MR, white label

### REAGENT SETS

[HI96784-25](#) Reagents for 25 tests

For other accessories see Accessories section.

**Note:** Store the unused vials in their packaging in a cool and dark place.

### PRINCIPLE

Nitrite is determined through formation of a reddish purple azo dye produced in acidic solution by coupling diazotized sulfanilamide with aromatic amines.

### APPLICATION

Wastewater, drinking water, surface water, mineral water, groundwater

### SIGNIFICANCE & USE

Nitrite is an intermediate oxidation state of nitrogen, both in the oxidation of ammonia to nitrate and in the reduction of nitrate. Such oxidation and reduction may occur in wastewater treatment plants, water distribution systems and natural waters. Nitrite can enter a water supply system through its use as a corrosion inhibitor in industrial process water. Nitrite changes the normal form of hemoglobin, which carries oxygen through blood to the rest of the body, into a form called methemoglobin that cannot carry oxygen.

### MEASUREMENT PROCEDURE

- Select the [Nitrite MR \(13 mm\)](#) method using the procedure described in the Factory Methods section.
- Insert the 13 mm vial adapter using the procedure described in the Cuvette & Vial Adapters section.
- Remove the cap from a [HI96784V-0](#) Nitrite Medium Range Reagent Vial.



- Add 0.4 mL of sample to the vial, while keeping the vial at a 45-degree angle.
- Replace the cap. Invert several times to mix. This is the blank.

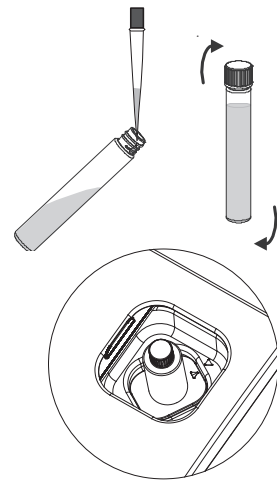

- Insert the vial into the adapter.
- Press **ZERO**. The display will show “-0-” when the meter is zeroed and ready for measurement.

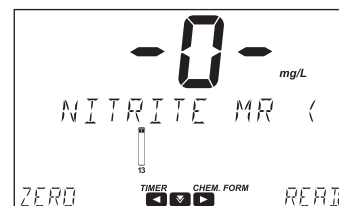
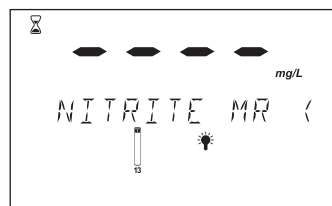
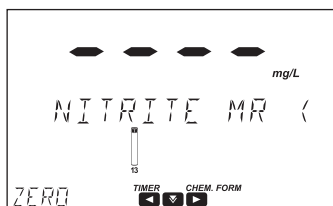

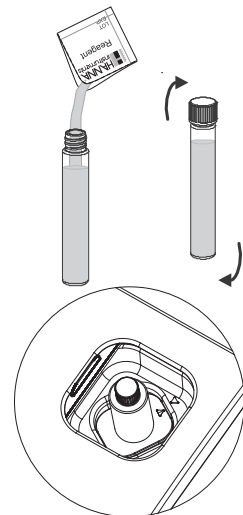

- Remove the vial.
- Remove the cap. Add one packet of **HI96784-0** Nitrite Medium Range Reagent for Vial.
- Replace the cap. Invert for 30 seconds to mix.

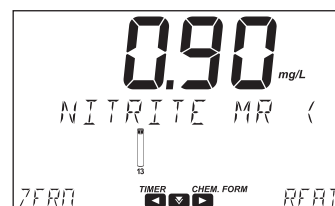
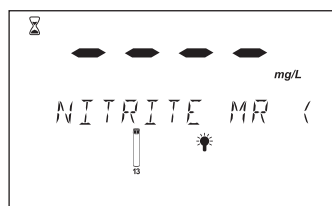
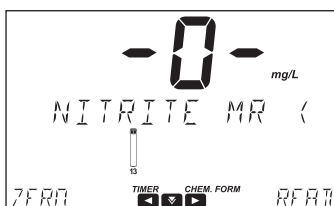
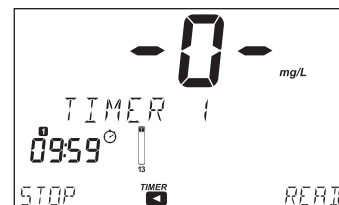
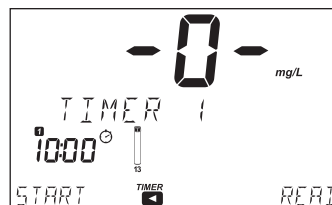
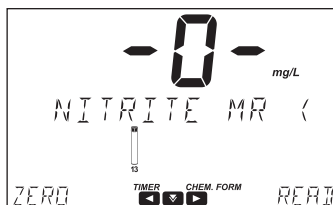

- Insert the vial into the adapter.
- Press the ◀ key to access the timer menu. Press **START** to start Timer 1, the display will show the countdown prior to measurement or wait 10 minutes.
- Press **READ** to start the reading. The instrument displays the results in mg/L of nitrite-nitrogen ( $\text{NO}_2^- \text{-N}$ ).



- Press the  key to view the wavelength, method ID, date and time.
- Press the  key to view the chemical formula.
- Press the  key to convert the results to mg/L of nitrite ( $\text{NO}_2^-$ ) or sodium nitrite ( $\text{NaNO}_2$ ).



- Press the  key to return to the measurement screen.

### INTERFERENCES

The pH of the sample must be between 2.0 and 3.0 after the addition of the reagents.

Interference may be caused by:

- Chlorine, Sodium, Sulfate above 4000 mg/L
- Potassium above 3000 mg/L
- Ammonium, Calcium, Nitrate, Phosphate above 2000 mg/L
- Magnesium above 1000 mg/L
- Copper above 200 mg/L
- Manganese, Zinc above 50 mg/L
- Nickel above 20 mg/L
- Iron above 10 mg/L

## Nitrite High Range

### SPECIFICATIONS

Range	0 to 150 mg/L (as NO <sub>2</sub> <sup>-</sup> )
Resolution	1 mg/L
Accuracy	± 4 mg/L ± 4% of reading at 25 °C
Wavelength	575 nm
Cuvette type	22 mm diameter
Method	Adaptation of the Ferrous Sulfate Method
Method ID	#059

### REQUIRED REAGENTS

Code	Description	Quantity
HI93708-0	Nitrite High Range Reagent	1 packet

### REAGENT SETS

HI93708-01 Reagents for 100 tests

HI93708-03 Reagents for 300 tests

For other accessories see Accessories section.

### MEASUREMENT PROCEDURE

- Select the **Nitrite HR** method using the procedure described in the Factory Methods section.

- Fill the cuvette with 10 mL of unreacted sample (up to the mark). Replace the plastic stopper and the cap.

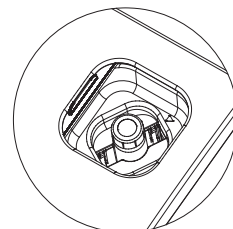

- Insert the cuvette into the holder and close the lid.
- Press **ZERO**. The display will show “-0-” when the meter is zeroed and ready for measurement.

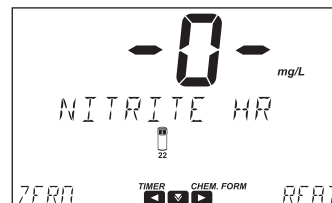
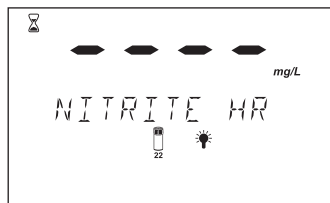
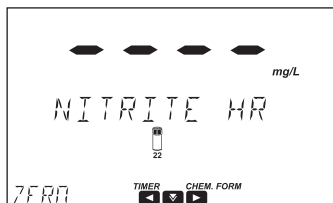

- Remove the cuvette.
- Add one packet of **HI93708-0** Nitrite High Range Reagent. Replace the plastic stopper and the cap. Shake gently until completely dissolved.

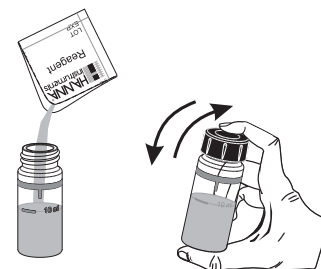

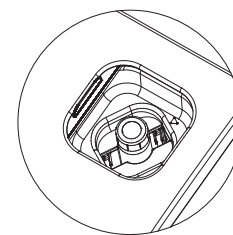

- Insert the cuvette into the holder and close the lid.
- Press the ◀ key to access the timer menu. Press **START** to start Timer 1, the display will show the countdown prior to measurement or wait 10 minutes.
- Press **READ** to start the reading. The instrument displays the results in mg/L of nitrite ( $\text{NO}_2^-$ ).

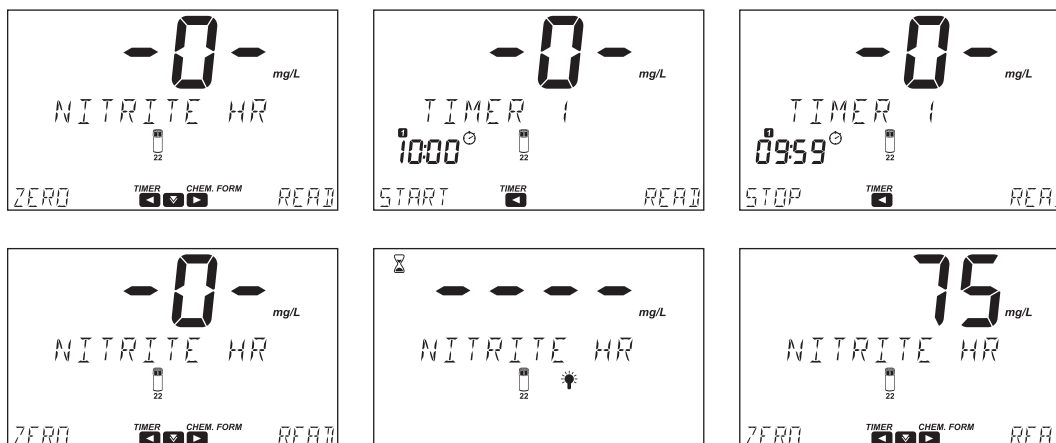

- Press the ▼ key to view the wavelength, method ID, date and time.
- Press the ▶ key to view the chemical formula.
- Press the ▲ key to convert the results to mg/L of nitrite-nitrogen ( $\text{NO}_2^-$ -N) or sodium nitrite ( $\text{NaNO}_2$ ).

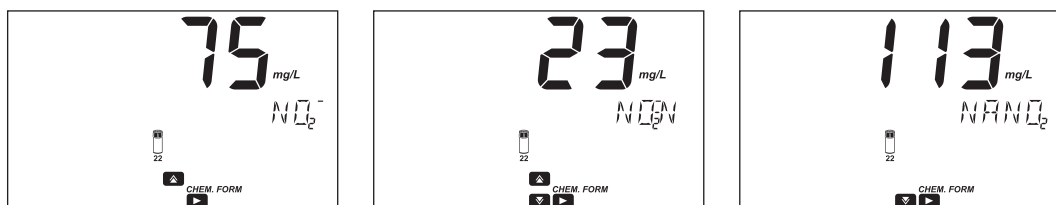

- Press the ▶ key to return to the measurement screen.

## Nitrogen, Total Low Range (13 mm Vial)

### SPECIFICATIONS

Range	0.0 to 25.0 mg/L (as N)
Resolution	0.1 mg/L
Accuracy	$\pm 1.0$ mg/L or $\pm 5\%$ of reading at 25 °C, whichever is greater
Wavelength	420 nm
Cuvette type	13 mm diameter
Method	Chromotropic Acid Method
Method ID	#060

### REQUIRED REAGENTS

Code	Description	Quantity
HI93767A-B*	Total Nitrogen Low Range Digestion Vial	2 vials
DEIONIZED120	Deionized Water	2 mL
PERSULFATE/N	Potassium Persulfate Reagent	2 packets
BISULFITE/N	Sodium Metabisulfite Reagent	2 packets
HI93767-0	Total Nitrogen Reagent	2 packets
HI93766V-OLR**	Total Nitrogen Low Range Reagent Vial	2 vials

\* Reagent vial identification: N LR, green label

\*\* Reagent vial identification: N LR, red label

### REAGENT SETS

HI93767A-50 Reagents for up to 49 tests

Box 1: HI93767A-50 Reagent Set

Box 2: HI93767A&B-50 Reagent Set, for Nitrogen Total Low Range

For other accessories see Accessories section.

**Note:** Store the unused vials in their packaging in a cool and dark place.

### MEASUREMENT PROCEDURE



Before using the reagent kit carefully read all the instructions and the Safety Data Sheets (SDS). Pay particular attention to all warnings, cautions and notes. Failure to do so may result in serious injury to the operator.

**Reagent Blank Correction:** This method requires a reagent blank correction. A single blank vial may be used more than once, the blank vial is stable for one week if stored in a dark place at room temperature. For improved accuracy use the same lot of reagents for the blank and sample, and run a blank for each set of measurements.

- Preheat the Hanna<sup>®</sup> Reactor HI839800 to 105 °C (221 °F). The optional HI740217 safety shield is strongly recommended.

**Warning:** Do not use an oven or microwave, samples may leak and generate a corrosive and possibly explosive atmosphere.

- Remove the cap from two HI93767A-B Total Nitrogen Low Range Digestion Vials.

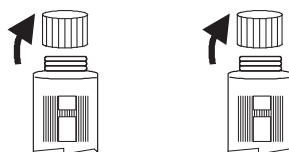

- Add one packet of **PERSULFATE/N** to each vial.

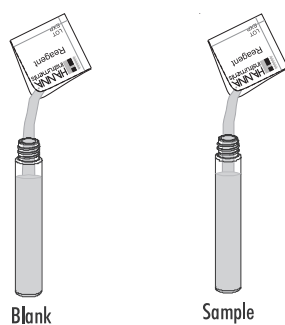

- Add 2 mL of deionized water to the first vial (#1) and 2 mL of sample to the second vial (#2), while keeping the vials at a 45-degree angle.

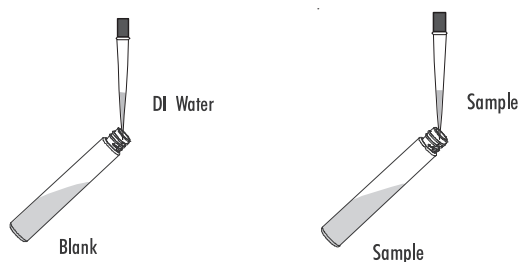

- Replace the cap. Shake vigorously for 30 seconds or until powder is completely dissolved.

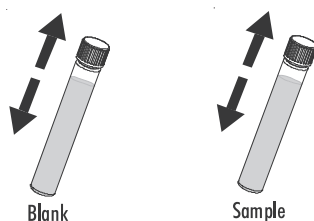

- Insert the vials into the reactor and heat them for 30 minutes at 105 °C.

**Note:** To obtain most accurate results, it is strongly recommended to remove the vials from the reactor after 30 minutes.



- At the end of the digestion period switch off the reactor, place the vials in the test tube rack and allow to cool to room temperature.

**Warning:** The vials are still hot, use caution when handling.

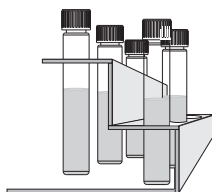

- Select **Nitrogen Total LR (13 mm)** method using the procedure described in the Factory Methods section.
- Insert 13 mm vial adapter using the procedure described in the Cuvette & Vial Adapters section.
- Remove the cap from the vials and add one packet of **BISULFITE/N** to each vial. Replace the cap. Shake gently for 15 seconds.

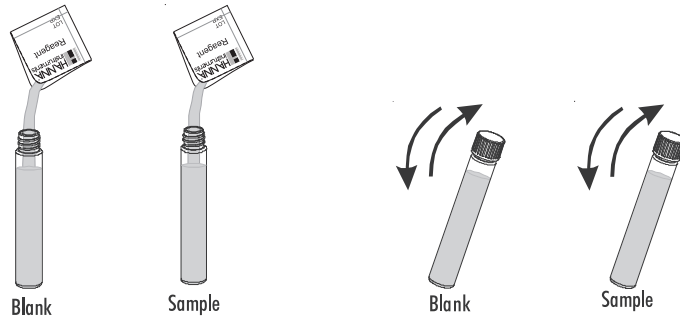

- Press the ◀ key to access the timer menu. Press **START** to start Timer 1, the display will show the countdown or wait 3 minutes.

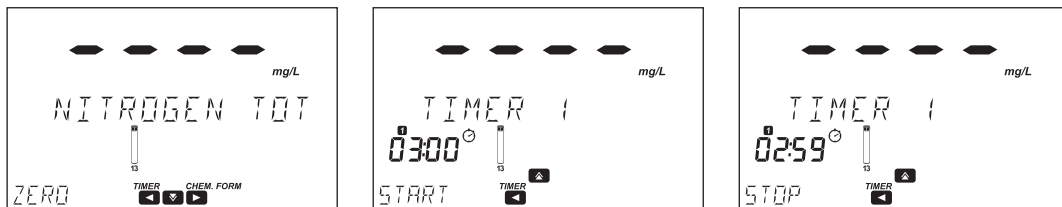

- Remove the cap from the vials and add one packet of **HI93767-0** Total Nitrogen Reagent to each vial. Replace the cap. Shake gently for 15 seconds.

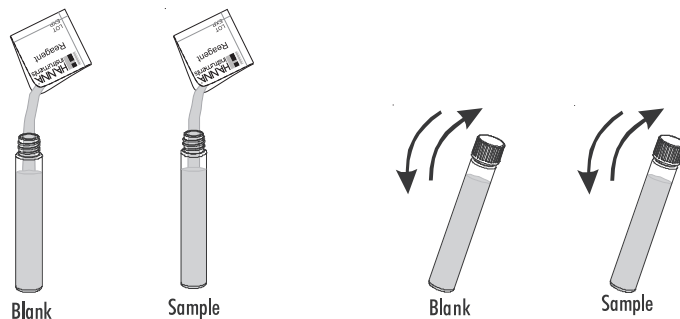

- Press the ◀ key to access the timer menu, press the ▲ key to select Timer 2. Press **START** to start Timer 2, the display will show the countdown or wait 2 minutes.

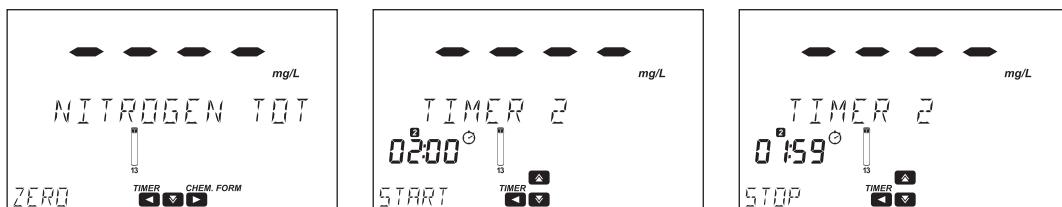

- Remove the cap from two **HI93766V-OLR** Total Nitrogen Low Range Reagent Vial.

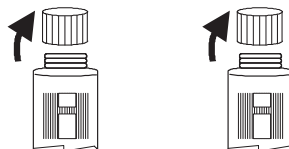



- Add 2 mL of digested blank (#1) to one of the reagent vials and 2 mL of digested sample (#2) to the second reagent vial, while keeping the vials at a 45-degree angle.
- Replace the cap and invert 10 times.

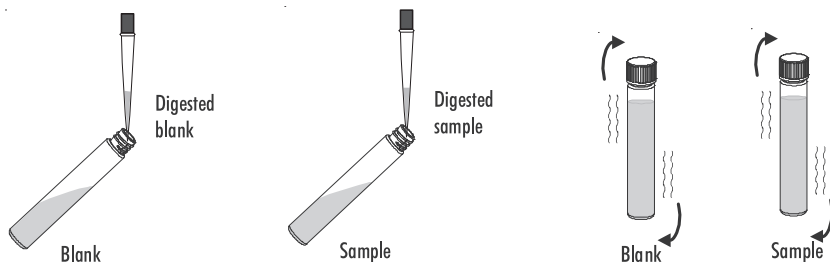

**Warning:** The vials will become hot during mixing, use caution when handling.

**Note:** The method is technique sensitive. See procedure described in the *Cuvette Preparation* section for proper mixing technique.

- Insert the blank vial (#1) into the adapter.

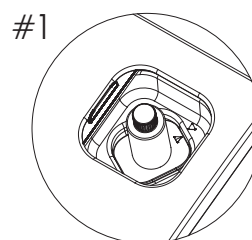

- Press the ◀ key to access the timer menu, press the ▲ key to select Timer 3. Press **START** to start Timer 3, the display will show the countdown prior to the zero or wait 5 minutes.

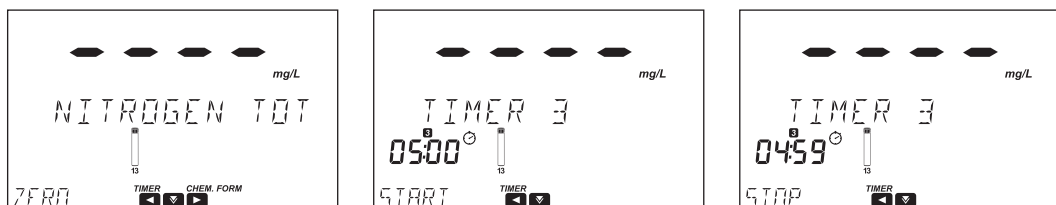

- Press **ZERO**. The display will show “-0-” when the meter is zeroed and ready for measurement.

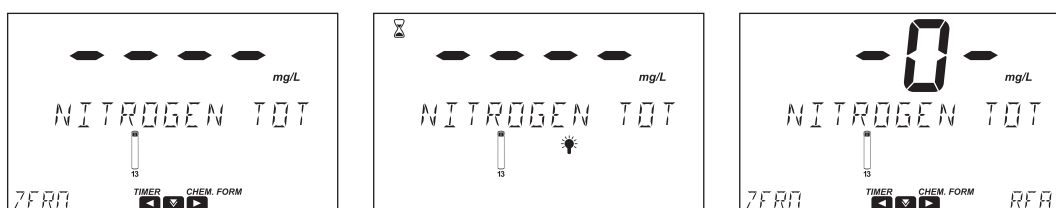

- Remove the blank vial.
- Insert the sample vial (#2) into the adapter.

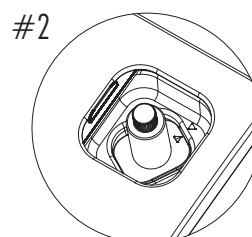

- Press **READ** to start the reading. The instrument displays the results in mg/L of nitrogen (N).

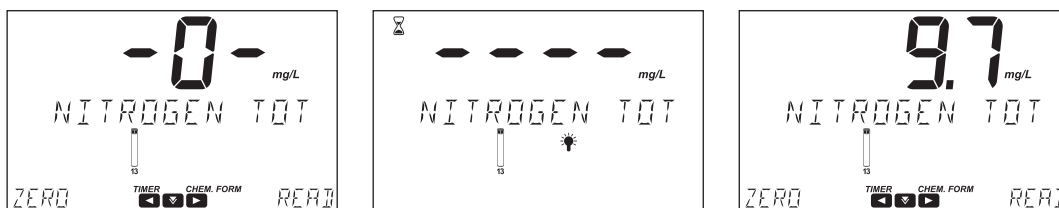

- Press the key to view the wavelength, method ID, date and time.
- Press the key to view the chemical formula.
- Press the key to convert the results to mg/L of ammonia (NH<sub>3</sub>) or nitrate (NO<sub>3</sub><sup>-</sup>).

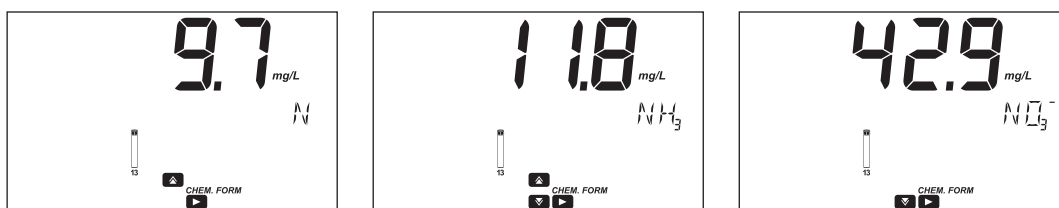

- Press the key to return to the measurement screen.

### INTERFERENCES

Interference may be caused by:

- Chloride above 1000 mg/L
- Bromide above 60 mg/L
- Chromium above 0.5 mg/L

## Nitrogen, Total High Range (13 mm Vial)

### SPECIFICATIONS

Range	10 to 150 mg/L (as N)
Resolution	1 mg/L
Accuracy	$\pm 3$ mg/L or $\pm 4\%$ of reading at 25 °C, whichever is greater
Wavelength	420 nm
Cuvette type	13 mm diameter
Method	Chromotropic Acid Method
Method ID	#061

### REQUIRED REAGENTS

Code	Description	Quantity
HI93767B-B*	Total Nitrogen High Range Digestion Vial	2 vials
DEIONIZED120	Deionized Water	0.5 mL
PERSULFATE/N	Potassium Persulfate Reagent	2 packets
BISULFITE/N	Sodium Metabisulfite Reagent	2 packets
HI93767-0	Total Nitrogen Reagent	2 packets
HI93766V-OHR**	Total Nitrogen High Range Reagent Vial	2 vials

\* Reagent vial identification: N HR, red label

\*\* Reagent vial identification: N HR, green label

### REAGENT SETS

HI93767B-50 Reagents for up to 49 tests

Box 1: HI93767B-50 Reagent Set

Box 2: HI93767A&B-50 Reagent Set, for Nitrogen Total High Range

For other accessories see Accessories section.

**Note:** Store the unused vials in their packaging in a cool and dark place.

### MEASUREMENT PROCEDURE



Before using the reagent kit carefully read all the instructions and the Safety Data Sheets (SDS). Pay particular attention to all warnings, cautions and notes. Failure to do so may result in serious injury to the operator.

**Reagent Blank Correction:** This method requires a reagent blank correction. A single blank vial may be used more than once, the blank vial is stable for one week if stored in a dark place at room temperature. For improved accuracy always use the same lot of reagents for the blank and sample, and run a blank for each set of measurements.

- Preheat the Hanna<sup>®</sup> Reactor HI839800 to 105 °C (221 °F). The optional HI740217 safety shield is strongly recommended.

**Warning:** Do not use an oven or microwave, samples may leak and generate a corrosive and possibly explosive atmosphere.

- Remove the cap from two HI93767B-B Total Nitrogen High Range Digestion Vials.



- Add one packet of **PERSULFATE/N** to each vial.

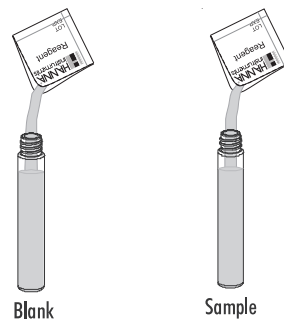

- Add 0.5 mL of deionized water to the first vial (#1) and 0.5 mL of sample to the second vial (#2), while keeping the vials at a 45-degree angle.

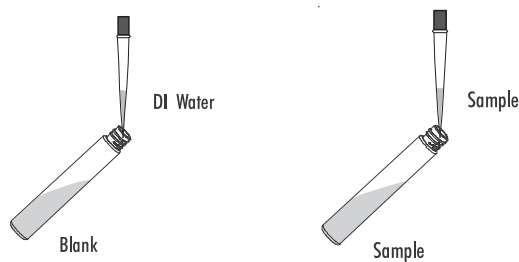

- Replace the cap and shake vigorously for about 30 seconds or until powder is completely dissolved.

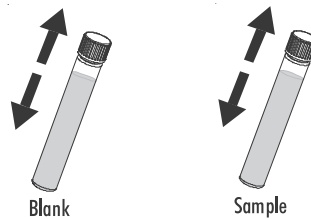

- Insert the vials into the reactor and heat them for 30 minutes at 105 °C.

**Note:** To obtain most accurate results, it is strongly recommended to remove the vials from the reactor after 30 minutes.



- At the end of the digestion place the vials in the test tube rack and allow to cool to room temperature.

**Warning:** The vials are still hot, use caution when handling.

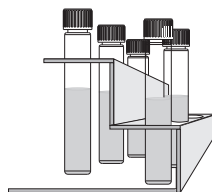

- Select **Nitrogen Total HR (13 mm)** method using the procedure described in the Factory Methods section.
- Insert the 13 mm vial adapter using the procedure described in the Cuvette & Vial Adapters section.

- Remove the cap from the vials and add one packet of **BISULFITE/N** to each vial. Replace the cap and shake gently for 15 seconds.

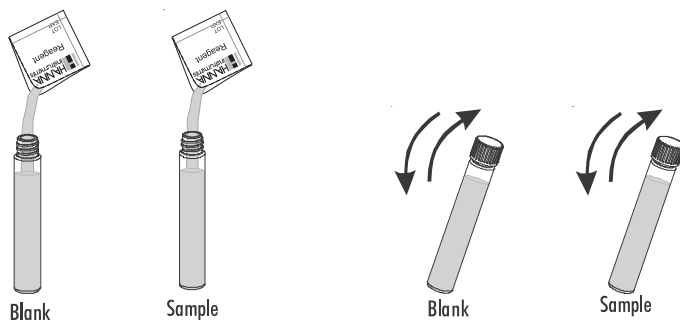

- Press the **◀** key to access the timer menu. Press **START** to start Timer 1, the display will show the countdown or wait 3 minutes.

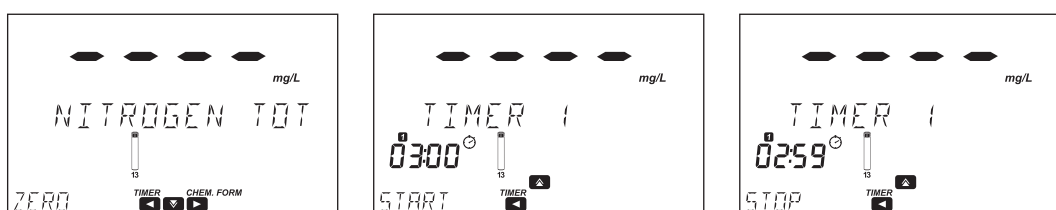

- Remove the cap from the vials and add one packet of **HI93767-0** Total Nitrogen Reagent to each vial. Replace the cap and shake gently for 15 seconds.

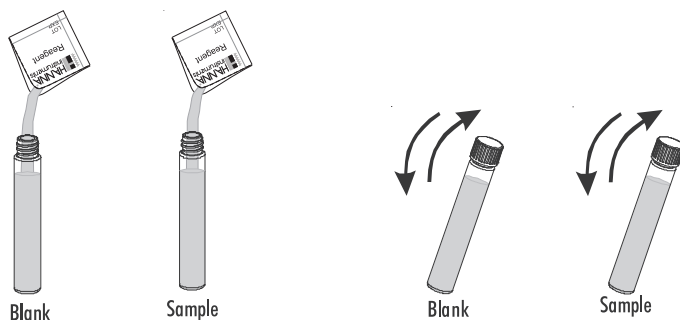

- Press the **◀** key to access the timer menu, press the **▲** key to select Timer 2. Press **START** to start Timer 2, the display will show the countdown or wait 2 minutes.

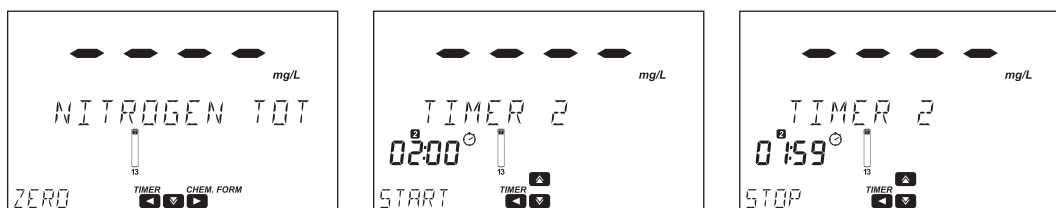

- Remove the cap from two **HI93766V-OHR** Total Nitrogen Low Range Reagent Vial.



- Add 2 mL of digested blank (#1) to one of the reagent vials and 2 mL of digested sample (#2) to the second reagent vial, while keeping the vials at a 45-degree angle.

- Replace the cap tightly and invert the vials 10 times.

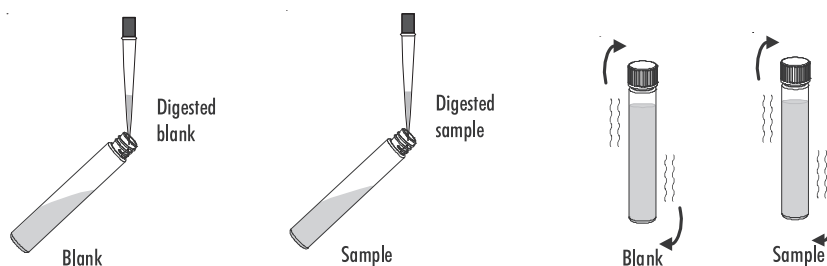

**Warning:** The vials will become hot during mixing, use caution when handling.

**Note:** The method is technique sensitive. See procedure described in the Cuvette Preparation section for proper mixing technique.

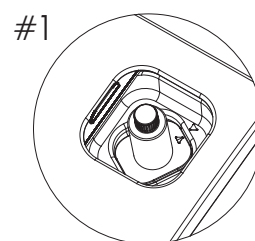

- Insert the blank vial (#1) into the adapter.
- Press the ◀ key to access the timer menu, press the ▲ key to select Timer 3. Press **START** to start Timer 3, the display will show the countdown prior to the zero or wait 5 minutes.

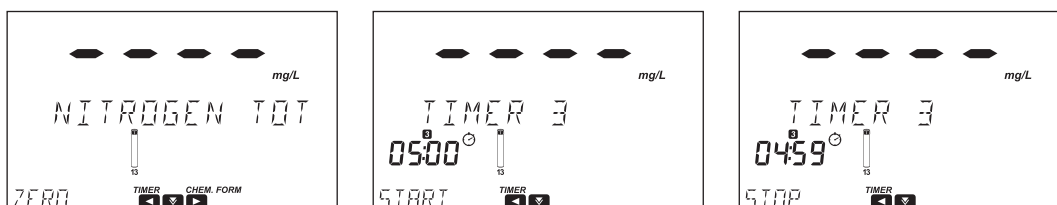

- Press **ZERO**. The display will show “-0-” when the meter is zeroed and ready for measurement.

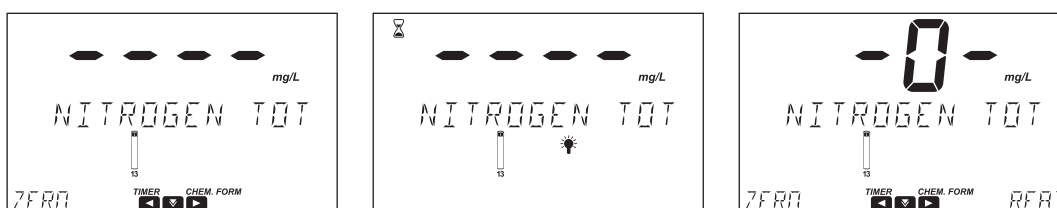

- Remove the blank vial.
- Insert the sample vial (#2) into the adapter.

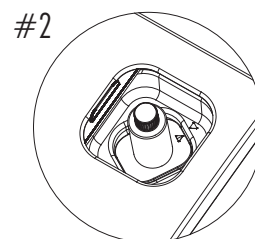

- Press **READ** to start the reading. The instrument displays the results in mg/L of nitrogen (N).

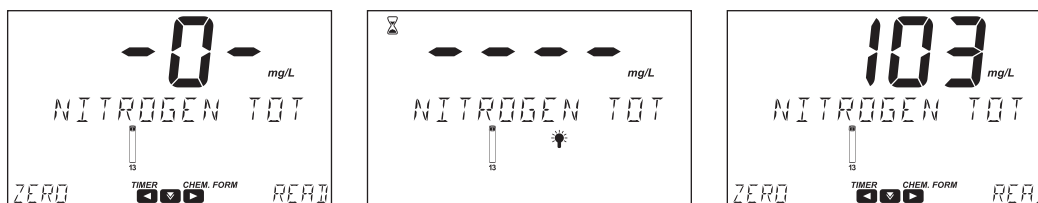

- Press the  $\nabla$  key to view the wavelength, method ID, date and time.
- Press the  $\blacktriangleright$  key to view the chemical formula.
- Press the  $\blacktriangle$  key to convert the results to mg/L of ammonia ( $\text{NH}_3$ ) or nitrate ( $\text{NO}_3^-$ ).

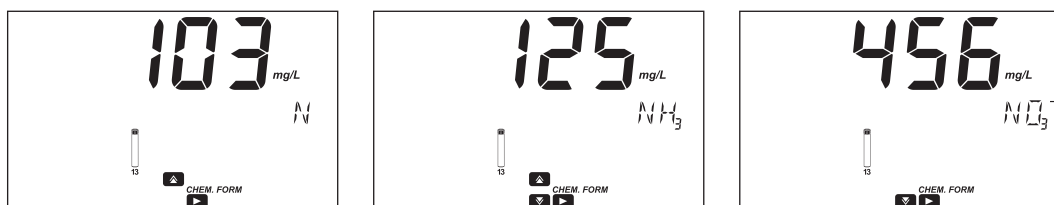

- Press the  $\blacktriangleright$  key to return to the measurement screen.

The method detects all organic and inorganic forms of nitrogen present in the sample.

## INTERFERENCES

Interference may be caused by:

- Chloride above 3000 mg/L
- Bromide above 240 mg/L
- Chromium above 0.5 mg/L

## Oxygen, Dissolved

### SPECIFICATIONS

Range	0.0 to 10.0 mg/L (as O <sub>2</sub> )
Resolution	0.1 mg/L
Accuracy	±0.4 mg/L ±3% of reading at 25 °C
Wavelength	466 nm
Cuvette type	22 mm diameter
Method	Adaptation of the Standard Methods for the Examination of Water and Wastewater, 18 <sup>th</sup> Edition, Azide Modified Winkler Method
Method ID	#062

### REQUIRED REAGENTS

Code	Description	Quantity
HI93732A-0	Dissolved Oxygen Reagent A	5 drops
HI93732B-0	Dissolved Oxygen Reagent B	5 drops
HI93732C-0	Dissolved Oxygen Reagent C	10 drops

### REAGENT SET

HI93732-01	Reagents for 100 tests
HI93732-03	Reagents for 300 tests

For other accessories see Accessories section.

### MEASUREMENT PROCEDURE

- Select the **Oxygen Dissolved** method using the procedure described in the Factory Methods section.
- Fill one 60 mL glass bottle completely with the unreacted sample.
- Replace the cap and ensure that a small part of the sample spills over.
- Remove the cap and add 5 drops of **HI93732A-0** and 5 drops of **HI93732B-0**.
- Add more sample, to fill the bottle completely. Replace the glass stopper and ensure that a part of the sample spills over.

**Note:** This ensures no air bubbles have been trapped inside the bottle. Trapped air bubbles could alter readings.

- Invert the bottle several times until the sample turns orange-yellow and a flocculating agent appears.
- Let the sample stand for approximately 2 minutes to allow flocculating agent to settle.
- When the upper half of the bottle is clear, add 10 drops of **HI93732C-0** Dissolved Oxygen Reagent C.

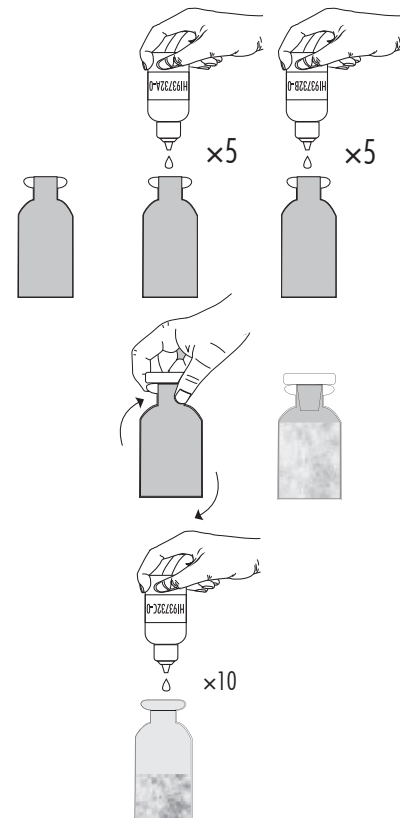



- Replace the glass stopper. Invert the bottle until the settled flocculating agent dissolves completely. The sample is ready for measurement when it is yellow and completely clear.

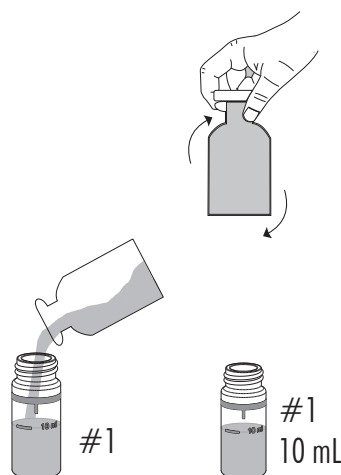

- Fill the first cuvette (#1) with 10 mL of the unreacted sample (up to the mark). Replace the plastic stopper and the cap.

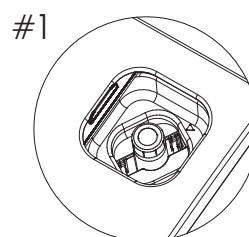

- Insert the cuvette into the holder and close the lid.

- Press **ZERO**. The display will show “-0-” when the meter is zeroed and ready for measurement.

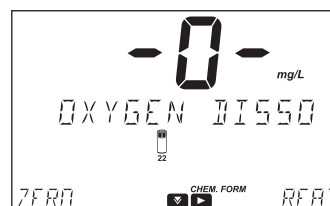
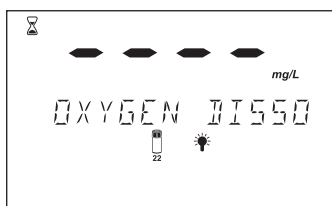
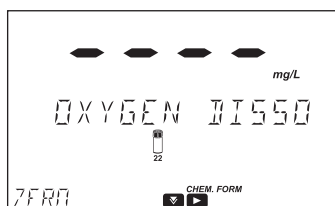

- Remove the cuvette.

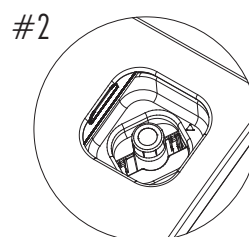
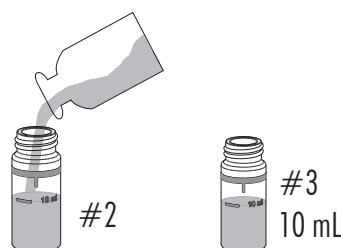

- Fill second cuvette (#2) with 10 mL of the reacted sample (up to the mark). Replace the plastic stopper and the cap.

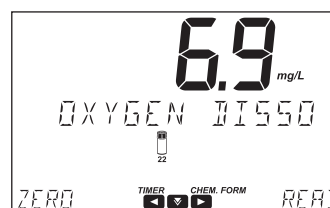
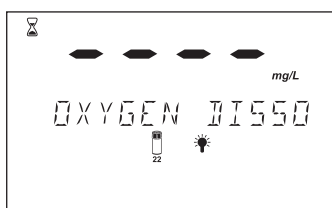
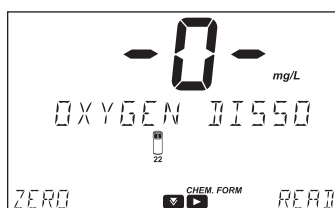

- Insert the cuvette into the holder and close the lid.

- Press **READ** to start the reading. The instrument will display the results in mg/L of oxygen (O<sub>2</sub>).



- Press the  key to view the wavelength, method ID, date and time.
- Press the  key to view the chemical formula.

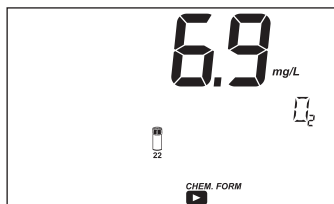

- Press the  key to return to the measurement screen.

### INTERFERENCES

Interferences may be caused by;

- Reducing and oxidizing materials

## Oxygen Scavengers (Carbohydrazide)

### SPECIFICATIONS

Range	0.00 to 1.50 mg/L (as Carbohydrazide)
Resolution	0.01 mg/L
Accuracy	$\pm 0.02$ mg/L $\pm 3\%$ of reading at 25 °C
Wavelength	575 nm
Cuvette type	22 mm diameter
Method	Adaptation of the Iron Reduction Method
Method ID	#063

### REQUIRED REAGENTS

Code	Description	Quantity
HI96773A-0	Oxygen Scavengers Reagent A	2 packets
HI96773B-0	Oxygen Scavengers Reagent B	1 mL

### REAGENT SET

HI96773-01	Reagents for 50 tests
HI96773-03	Reagents for 150 tests

For other accessories see Accessories section.

### MEASUREMENT PROCEDURE

- Select the **Oxygen Scavengers (Carbohy)** method using the procedure described in the Factory Methods section.

- Fill first cuvette (#1) with 10 mL of deionized water (up to the mark).
- Fill second cuvette (#2) with 10 mL of sample (up to the mark).

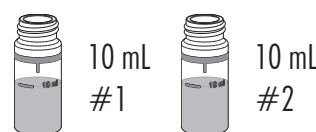

- Add one packet of **HI96773A-0** Oxygen Scavengers Reagent A to cuvette #1. Replace the plastic stopper and the cap. Invert for 30 seconds.

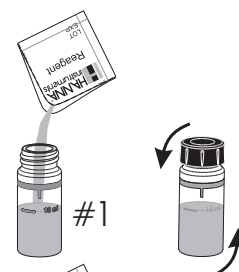

- Add one packet of **HI96773A-0** Oxygen Scavengers Reagent A to cuvette #2. Replace the plastic stopper and the cap. Invert for 30 seconds.

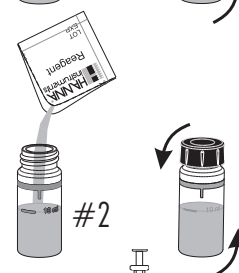

- Add 0.5 mL of **HI96773B-0** Oxygen Scavengers Reagent B to each cuvette using the 1 mL syringe.

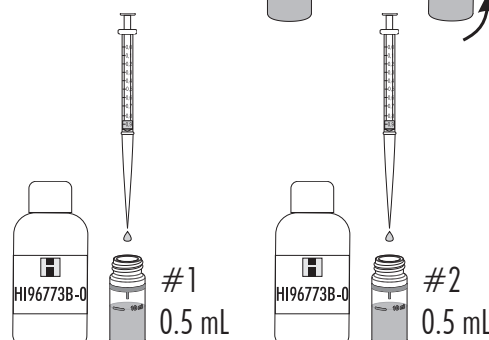

- Replace the plastic stoppers and the caps. Invert for 10 seconds.



#1

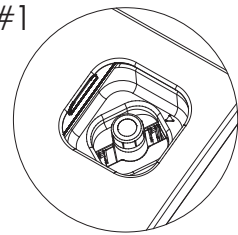

- Insert first cuvette (#1) into the holder and close the lid.
- Press the ◀ key to access the timer menu. Press **START** to start Timer 1, the display will show the countdown prior to the zero or wait 10 minutes.
- Press **ZERO**. The display will show “-0-” when the meter is zeroed and ready for measurement.

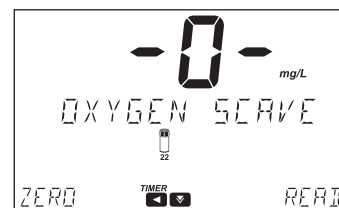
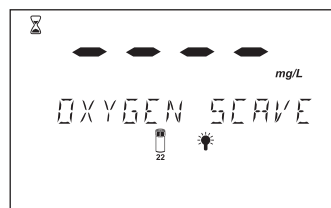
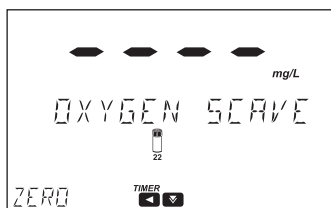
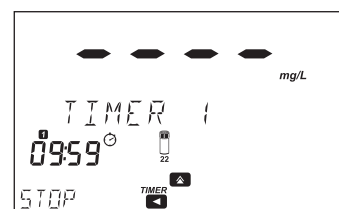
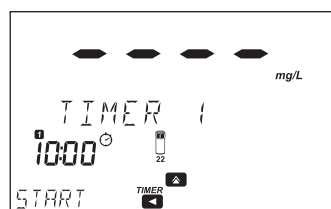
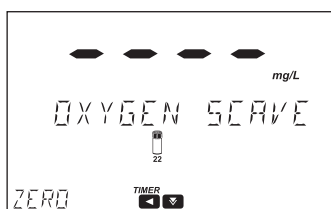

- Remove the cuvette.
- Insert the second cuvette (#2) into the holder and close the lid.

#2

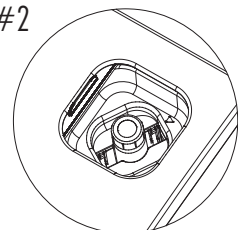

- Press **READ** to start reading. The instrument displays the results in **mg/L** of **carbohydrazide**.

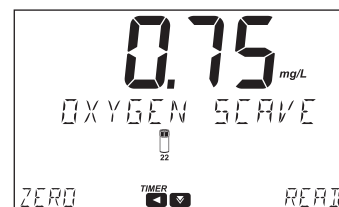
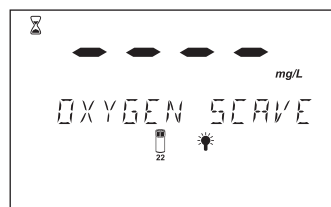
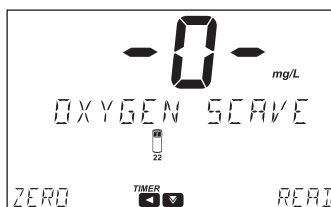

- Press the ▼ key to view the wavelength, method ID, date and time.

## INTERFERENCES

Interference may be caused by:

- Borate (as  $\text{Na}_2\text{B}_4\text{O}_7$ ), Cobalt, Copper, Iron (Ferrous), Hardness (as  $\text{CaCO}_3$ ), Light, Lignosulfonates, Manganese, Molybdenum, Nickel, Phosphate, Phosphonates, Sulfate, Temperature and Zinc

## Oxygen Scavengers (Diethylhydroxylamine) (DEHA)

### SPECIFICATIONS

Range	0 to 1000 $\mu\text{g/L}$ (as DEHA)
Resolution	1 $\mu\text{g/L}$
Accuracy	$\pm 5 \mu\text{g/L} \pm 5\%$ of reading at 25 °C
Wavelength	575 nm
Cuvette type	22 mm diameter
Method	Adaptation of the Iron Reduction Method
Method ID	#064

### REQUIRED REAGENTS

Code	Description	Quantity
HI96773A-0	Oxygen Scavengers Reagent A	2 packets
HI96773B-0	Oxygen Scavengers Reagent B	1 mL

### REAGENT SET

HI96773-01	Reagents for 50 tests
HI96773-03	Reagents for 150 tests

For other accessories see Accessories section.

### MEASUREMENT PROCEDURE

- Select the **Oxygen Scavengers (DEHA)** method using the procedure described in the Factory Methods section.

- Fill first cuvette (#1) with 10 mL of deionized water (up to the mark).
- Fill second cuvette (#2) with 10 mL of sample (up to the mark).

- Add one packet of **HI96773A-0** Oxygen Scavengers Reagent A to #1 cuvette. Replace the plastic stopper and the cap. Invert for 30 seconds.

- Add one packet of **HI96773A-0** Oxygen Scavengers Reagent A to #2 cuvette. Replace the plastic stopper and the cap. Invert for 30 seconds.

- Add 0.5 mL of **HI96773B-0** Oxygen Scavengers Reagent B to each cuvette using the 1 mL syringe.

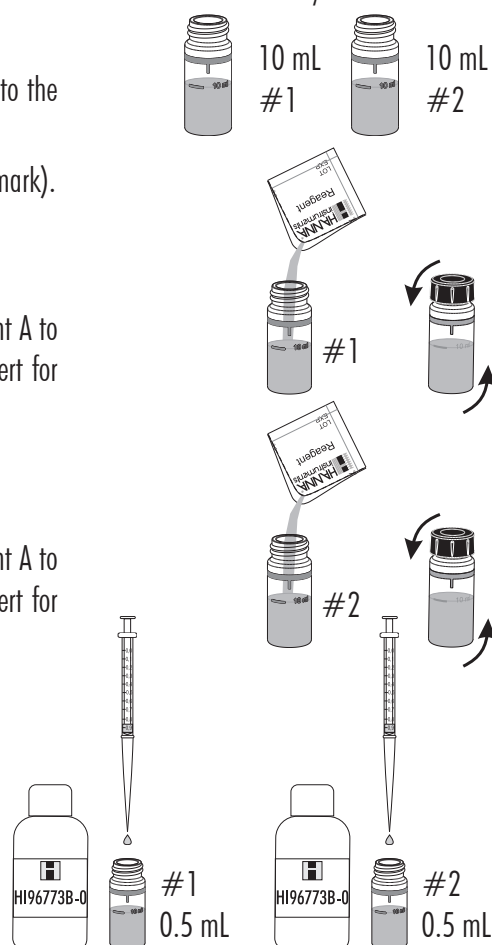

- Replace the plastic stoppers and the caps. Invert for 10 seconds.



#1

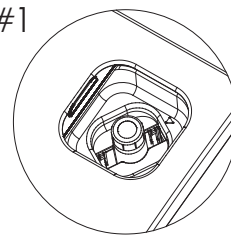

- Insert first cuvette (#1) into the holder and close the lid.

- Press the ◀ key to access the timer menu. Press **START** to start Timer 1, the display will show the countdown prior to the zero or wait 10 minutes.
- Press **ZERO**. The display will show “-0-” when the meter is zeroed and ready for measurement.

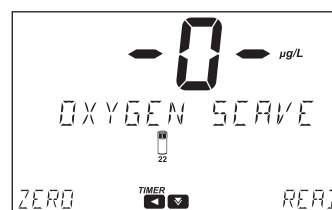
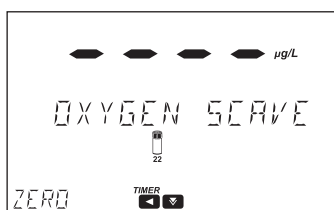
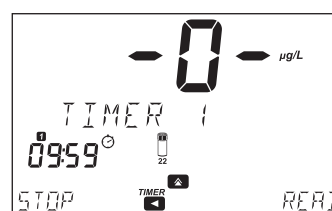
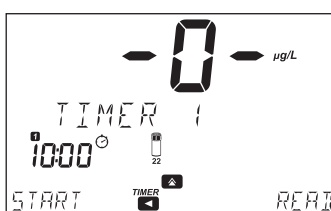
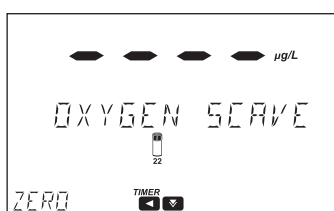

- Remove the cuvette.
- Insert the second cuvette (#2) into the holder and close the lid.

#2

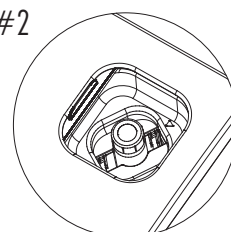

- Press **READ** to start reading. The instrument displays the results in  $\mu\text{g/L}$  of DEHA.

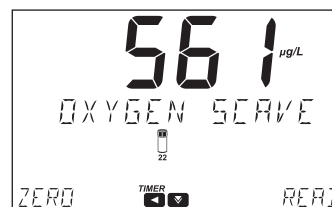
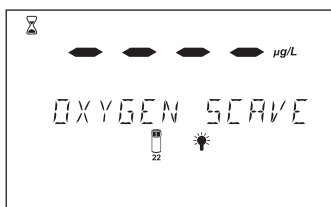
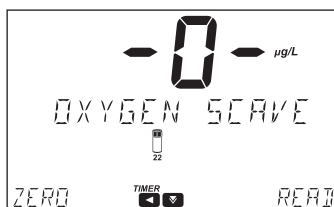

- Press the ▼ key to view the wavelength, method ID, date and time.

## INTERFERENCES

Interference may be caused by:

- Borate (as  $\text{Na}_2\text{B}_4\text{O}_7$ ), Cobalt, Copper, Iron (Ferrous), Hardness (as  $\text{CaCO}_3$ ), Light, Lignosulfonates, Manganese, Molybdenum, Nickel, Phosphate, Phosphonates, Sulfate, Temperature and Zinc

## Oxygen Scavengers (Hydroquinone)

### SPECIFICATIONS

Range	0.00 to 2.50 mg/L (as Hydroquinone)
Resolution	0.01 mg/L
Accuracy	$\pm 0.04$ mg/L $\pm 3\%$ of reading at 25 °C
Wavelength	575 nm
Cuvette type	22 mm diameter
Method	Adaptation of Iron Reduction Method
Method ID	#065

### REQUIRED REAGENTS

Code	Description	Quantity
HI96773A-0	Oxygen Scavengers Reagent A	2 packets
HI96773B-0	Oxygen Scavengers Reagent B	1 mL

### REAGENT SET

HI96773-01	Reagents for 50 tests
HI96773-03	Reagents for 150 tests

For other accessories see Accessories section.

### MEASUREMENT PROCEDURE

- Select the [Oxygen Scavengers \(Hydro\)](#) method using the procedure described in the Factory Methods section.

- Fill first cuvette (#1) with 10 mL of deionized water (up to the mark).
- Fill second cuvette (#2) with 10 mL of sample (up to the mark).

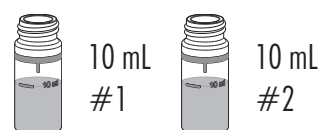

- Add one packet of [HI96773A-0](#) Oxygen Scavengers Reagent A to #1 cuvette. Replace the plastic stopper and the cap. Invert for 30 seconds.

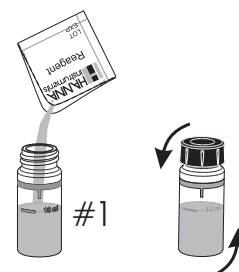

- Add one packet of [HI96773A-0](#) Oxygen Scavengers Reagent A to #2 cuvette. Replace the plastic stopper and the cap. Invert for 30 seconds.

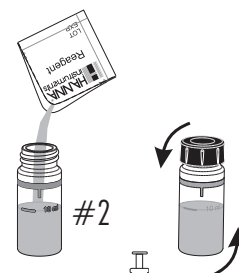

- Add 0.5 mL of [HI96773B-0](#) Oxygen Scavengers Reagent B to each cuvette using the 1 mL syringe.

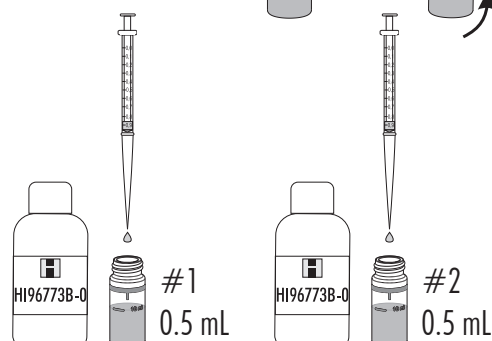

- Replace the plastic stoppers and the caps. Invert for 10 seconds.



#1

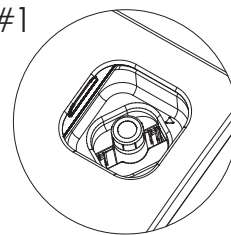

- Insert the first cuvette (#1) into the holder and close the lid.
- Press the ◀ key to access the timer menu. Press **START** to start Timer 1, the display will show the countdown prior to the zero or wait 2 minutes.
- Press **ZERO**. The display will show “-0-” when the meter is zeroed and ready for measurement.

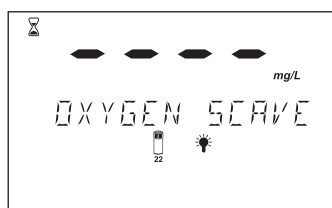
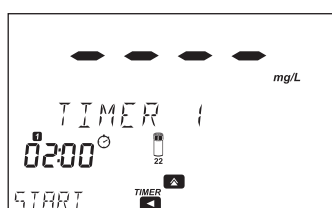
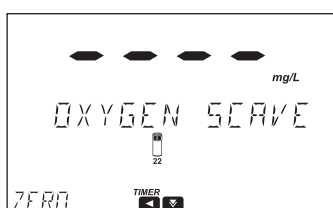

- Remove the cuvette.
- Insert the second cuvette (#2) into the holder and close the lid.

#2

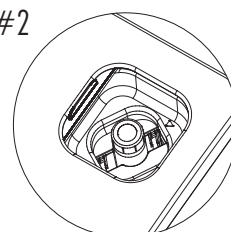

- Press **READ** to start reading. The instrument displays the results in **mg/L** of hydroquinone.

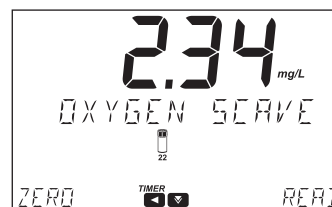
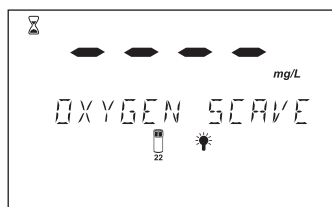
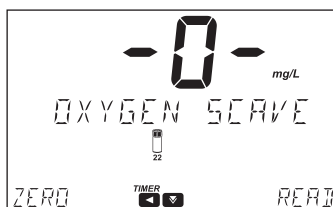

- Press the ▼ key to view the wavelength, method ID, date and time.

## INTERFERENCES

Interference may be caused by:

- Borate (as  $\text{Na}_2\text{B}_4\text{O}_7$ ), Cobalt, Copper, Iron (Ferrous), Hardness (as  $\text{CaCO}_3$ ), Light, Lignosulfonates, Manganese, Molybdenum, Nickel, Phosphate, Phosphonates, Sulfate, Temperature and Zinc



## Oxygen Scavengers (Isoascorbic Acid)

### SPECIFICATIONS

Range	0.00 to 4.50 mg/L (as Iso-Ascorbic Acid)
Resolution	0.01 mg/L
Accuracy	$\pm 0.03$ mg/L $\pm 3$ % of reading at 25 °C
Wavelength	575 nm
Cuvette type	22 mm diameter
Method	Adaptation of the Iron Reduction Method
Method ID	#066

### REQUIRED REAGENTS

Code	Description	Quantity
HI96773A-0	Oxygen Scavengers Reagent A	2 packets
HI96773B-0	Oxygen Scavengers Reagent B	1 mL

### REAGENT SET

HI96773-01	Reagents for 50 tests
HI96773-03	Reagents for 150 tests

For other accessories see Accessories section.

### MEASUREMENT PROCEDURE

- Select the [Oxygen Scavengers \(ISA\)](#) method using the procedure described in the Factory Methods section.

- Fill first cuvette (#1) with 10 mL of deionized water (up to the mark).
- Fill second cuvette (#2) with 10 mL of sample (up to the mark).

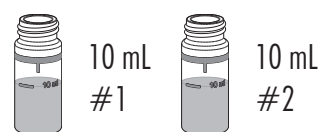

- Add one packet of [HI96773A-0](#) Oxygen Scavengers Reagent A to #1 cuvette. Replace the plastic stopper and the cap. Invert for 30 seconds.

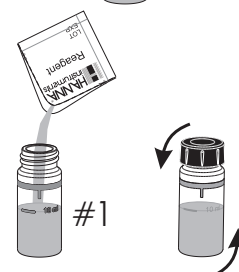

- Add one packet of [HI96773A-0](#) Oxygen Scavengers Reagent A to #2 cuvette. Replace the plastic stopper and the cap. Invert for 30 seconds.

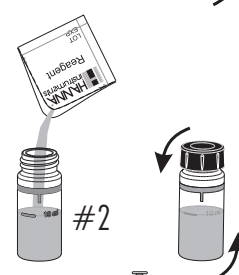

- Add 0.5 mL of [HI96773B-0](#) Oxygen Scavengers Reagent B to each cuvette using the 1 mL syringe.

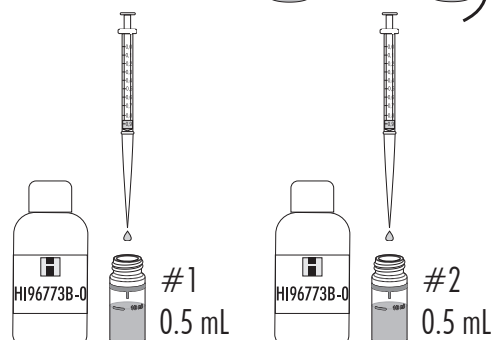

- Replace the plastic stoppers and the caps. Invert for 10 seconds.

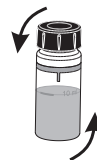

#1

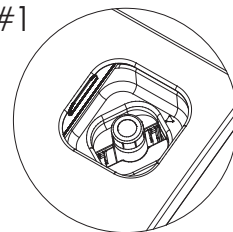

- Insert the first cuvette (#1) into the holder and close the lid.

- Press the ◀ key to access the timer menu. Press **START** to start Timer 1, the display will show the countdown prior to the zero or wait 10 minutes.
- Press **ZERO**. The display will show “-0-” when the meter is zeroed and ready for measurement.

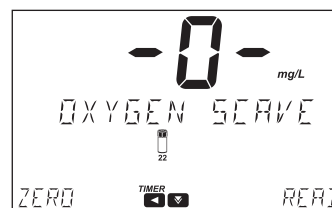
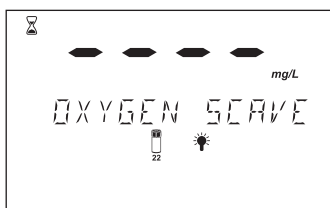
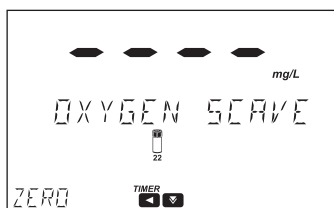
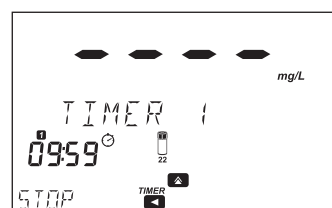
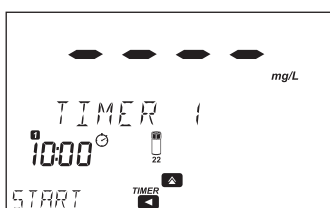
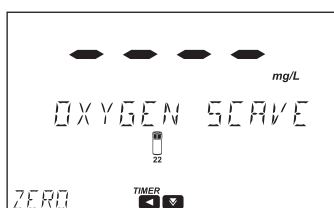

- Remove the cuvette.
- Insert the second cuvette (#2) into the holder and close the lid.

#2

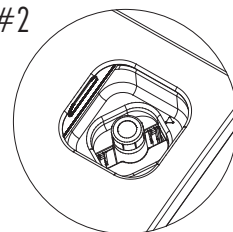

- Press **READ** to start reading. The instrument displays the results in **mg/L** of iso-ascorbic acid.

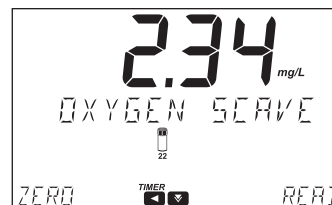
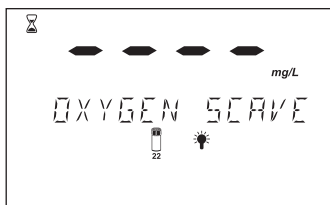
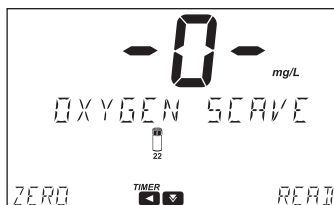

- Press the ▼ key to view the wavelength, method ID, date and time.

## INTERFERENCES

Interference may be caused by:

- Borate (as  $\text{Na}_2\text{B}_4\text{O}_7$ ), Cobalt, Copper, Iron (Ferrous), Hardness (as  $\text{CaCO}_3$ ), Light, Lignosulfonates, Manganese, Molybdenum, Nickel, Phosphate, Phosphonates, Sulfate, Temperature and Zinc

## Ozone

### SPECIFICATIONS

Range	0.00 to 2.00 mg/L (as O <sub>3</sub> )
Resolution	0.01 mg/L
Accuracy	±0.02 mg/L ±3% of reading at 25 °C
Wavelength	525 nm
Cuvette type	22 mm diameter
Method	Colorimetric DPD Method
Method ID	#067

### REQUIRED REAGENTS

Code	Description	Quantity
HI93757-0	Ozone Reagent	1 packet
HI93703-52-0	Glycine Powder (Optional Reagent)	1 packet

### REAGENT SETS

HI93757-01	Reagents for 100 tests
HI93757-03	Reagents for 300 tests
HI93703-52	Reagents for 100 tests (Optional)

For other accessories see Accessories section.

### STANDARD MEASUREMENT PROCEDURE

#### Chlorine free samples

- Select the **Ozone** method using the procedure described in the Factory Methods section.

- Fill the cuvette with 10 mL of unreacted sample (up to the mark).  
Replace the plastic stopper and the cap.



- Insert the cuvette into the holder and close the lid.

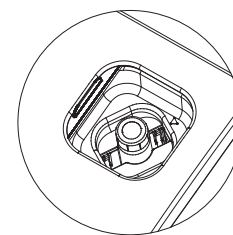

- Press **ZERO**. The display will show “-0-” when the meter is zeroed and ready for measurement.

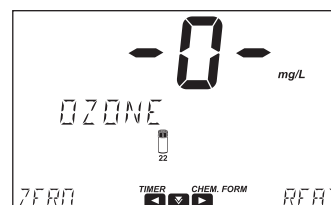
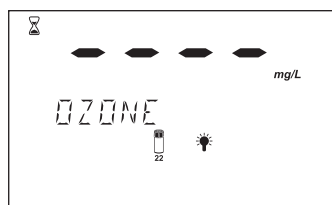
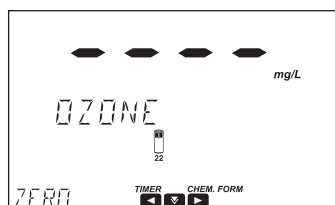

- Remove the cuvette.
- Add one packet of HI93757-0 Ozone Reagent. Replace the plastic stopper and the cap. Shake gently for 20 seconds.

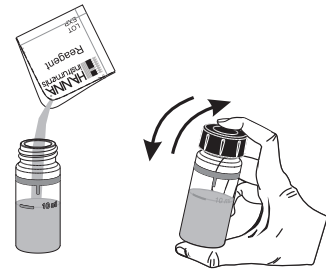

- Insert the cuvette into the holder and close the lid.

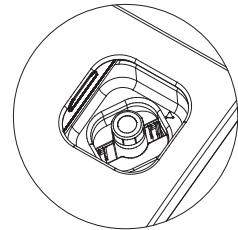

- Press the ◀ key to access the timer menu. Press **START** to start Timer 1, the display will show the countdown prior to measurement or wait 2 minutes.
- Press **READ** to start the reading. The instrument displays the results in mg/L of ozone ( $O_3$ ) (chlorine-free sample only). For samples containing chlorine, record this value as A.

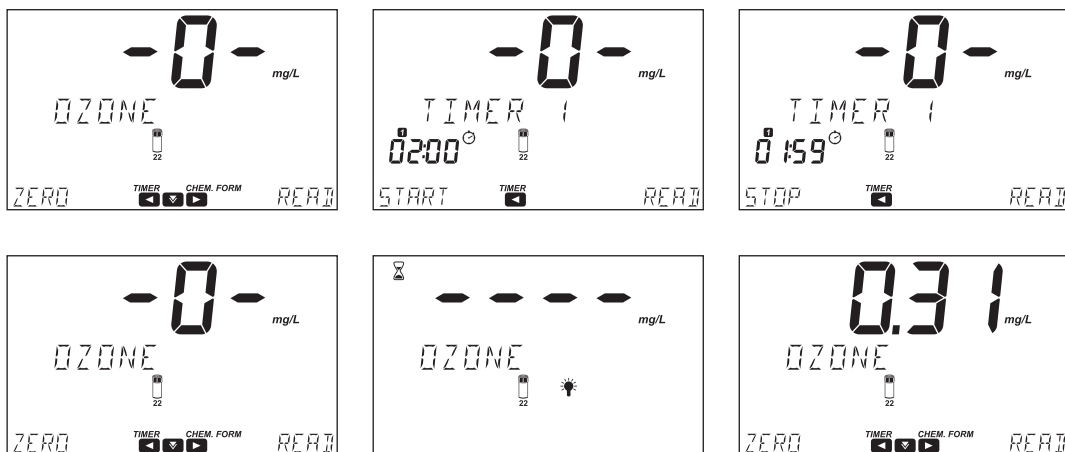

### ADDITIONAL MEASUREMENT PROCEDURE

#### Samples containing chlorine

- Fill the cuvette with 10 mL of unreacted sample (up to the mark). Replace the plastic stopper and the cap.
- Insert the cuvette into the holder and close the lid.
- Press **ZERO**. The display will show “-0-” when the meter is zeroed and ready for measurement.

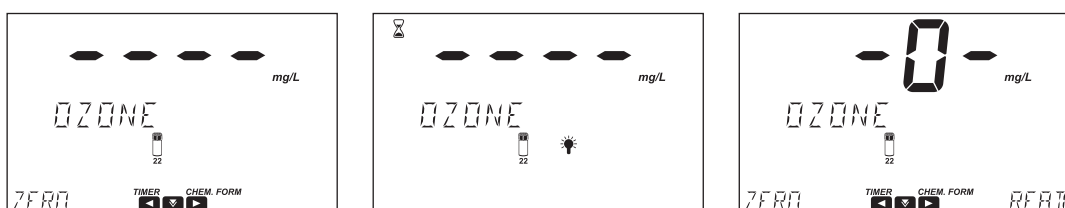
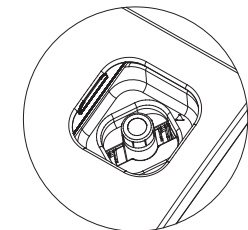

- Remove the cuvette.
- Add one packet of the [HI93703-52-0](#) Glycine Powder. Replace the plastic stopper and the cap. Shake gently until completely dissolved.
- Add one packet of [HI93757-0](#) Ozone Reagent. Replace the plastic stopper and the cap. Shake gently for 20 seconds.

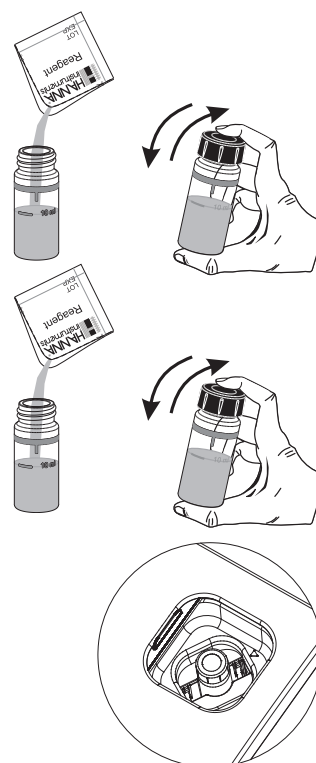

- Insert the cuvette into the holder and close the lid.
- Press the ◀ key to access the timer menu. Press **START** to start Timer 1, the display will show the countdown prior to measurement or wait 2 minutes.
- Press **READ** to start the reading. Record this value as B.

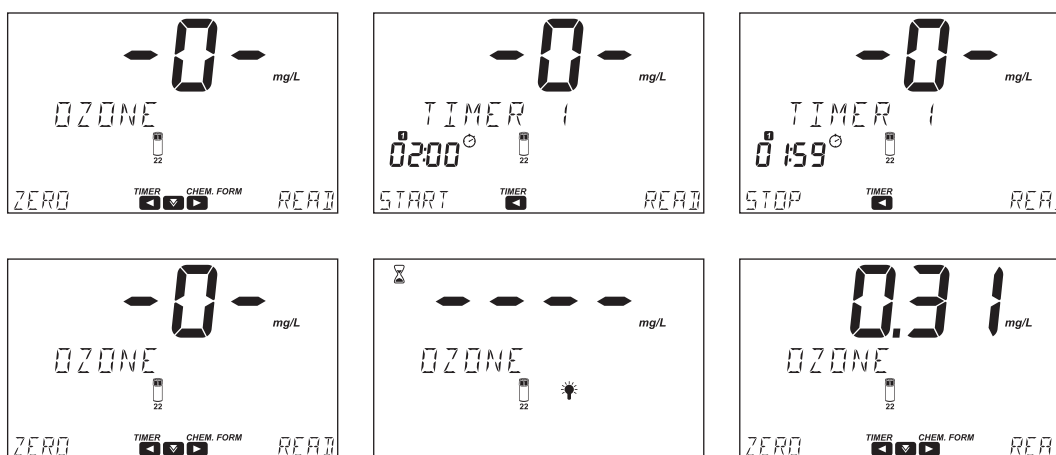

- To determine the **mg/L of ozone (O<sub>3</sub>)** concentration in sample containing chlorine, subtract value B (additional measurement procedure) from value A (standard measurement procedure).
- Press the ▼ key to view the wavelength, method ID, date and time.
- Press the ► key to view the chemical formula.

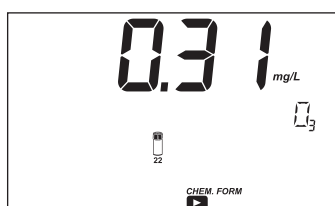

- Press the ► key to return to the measurement screen.

## INTERFERENCES

Interference may be caused by:

- Bromine, Chlorine Dioxide, Iodine
- Hardness greater than 500 mg/L CaCO<sub>3</sub>, shake the sample for approximately 2 minutes after adding the powder reagent
- Alkalinity above 250 mg/L CaCO<sub>3</sub> will not reliably develop the full amount of color or it may rapidly fade, neutralize the sample with diluted HCl.
- If the sample is suspected to contain chlorine residue (free or total chlorine), follow the alternative measurement procedure described below, chlorine is a strong interferent.
  1. Perform the Standard Measurement Procedure. Record the result as Value A.
  2. Perform Additional Measurement Procedure. Record the result as Value B.
  3. To determine the ozone concentration in mg/L, subtract Value B from Value A.

$$\text{mg/L ozone (O}_3\text{)} = \text{Value A} - \text{Value B}$$

## pH

## SPECIFICATIONS

Range	6.5 to 8.5 pH
Resolution	0.1 pH
Accuracy	$\pm 0.1$ pH at 25 °C
Wavelength	525 nm
Cuvette type	22 mm diameter
Method	Adaptation of the Phenol Red Method
Method ID	#068

## REQUIRED REAGENTS

Code	Description	Quantity
HI93710-0	pH Reagent	5 drops

## REAGENT SETS

HI93710-01 Reagents for 100 pH tests

HI93710-03 Reagents for 300 pH tests

For other accessories see Accessories section.

## MEASUREMENT PROCEDURE

- Select the **pH** method using the procedure described in the Factory Methods section.

- Fill the cuvette with 10 mL of unreacted sample (up to the mark). Replace the plastic stopper and the cap.



- Insert the cuvette into the holder and close the lid.

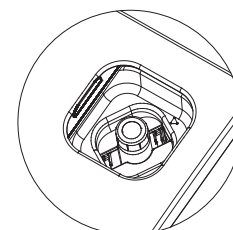

- Press **ZERO**. The display will show “-0-” when the meter is zeroed and ready for measurement.

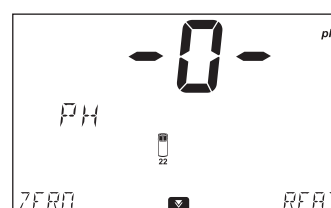
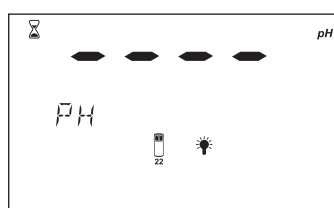
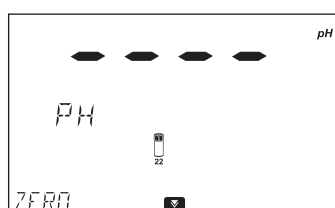

- Remove the cuvette and add 5 drops of HI93710-0 pH Reagent Indicator. Replace the plastic stopper and the cap. Mix the solution.

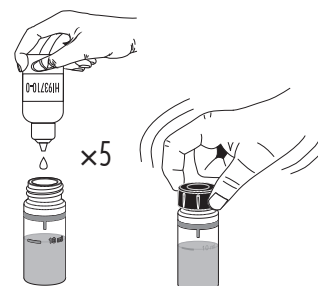

- Insert the cuvette into the holder and close the lid.

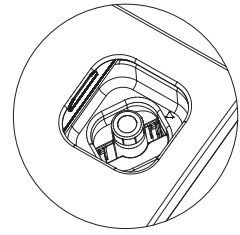

- Press **READ** to start the reading. The instrument displays the result in **pH**.

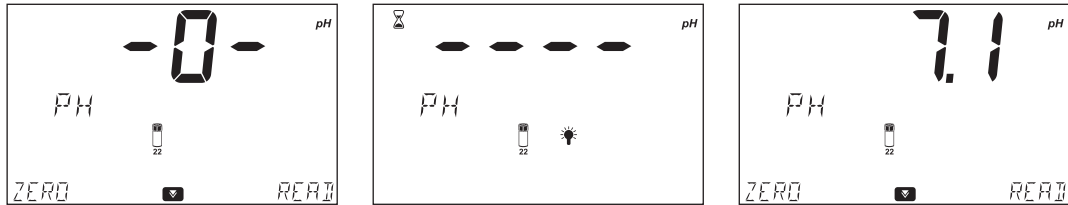

- Press the  key to view the wavelength, method ID, date and time.



## Phosphorus, Marine Ultra Low Range

### SPECIFICATIONS

Range	0 to 200 $\mu\text{g/L}$ (as P)
Resolution	1 $\mu\text{g/L}$
Accuracy	$\pm 5 \mu\text{g/L} \pm 5\%$ of reading at 25 °C
Wavelength	610 nm
Cuvette type	22 mm diameter
Method	Adaptation of Standard Methods for the Examination of Water and Wastewater, 20 <sup>th</sup> Edition, Ascorbic Acid Method
Method ID	#069

### REQUIRED REAGENTS

Code	Description	Quantity
H1736-25	Phosphorus Ultra Low Range Marine Reagent	1 packet

### REAGENT SETS

H1736-25 Reagents for 25 tests  
For other accessories see Accessories section.

### MEASUREMENT PROCEDURE

- Select the [Phosphorus Marine ULR](#) method using the procedure described in the Factory Methods section.
- Rinse the cuvette, plastic stopper and cap several times with unreacted sample.
- Fill the cuvette with 10 mL of sample (up to the mark). Replace the plastic stopper and the cap.
- Insert the cuvette into the holder and close the lid.
- Press **ZERO**. The display will show “-0-” when the meter is zeroed and ready for measurement.

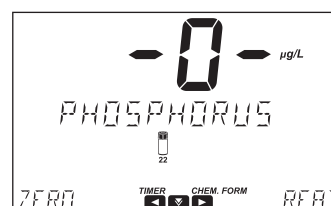
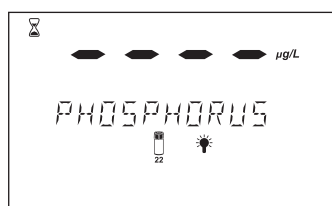
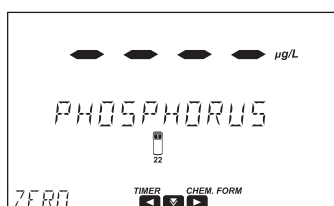
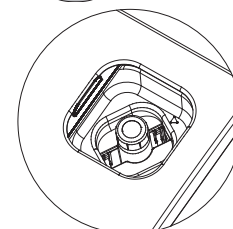

- Add one packet of [H1736-25](#) Phosphorus Ultra Low Range Marine Reagent. Replace the plastic stopper and the cap. Shake gently (for about 2 minutes) until the powder is completely dissolved.

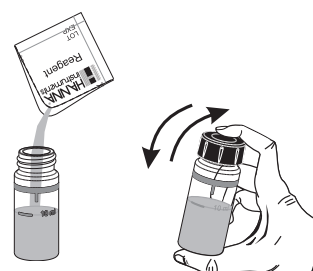

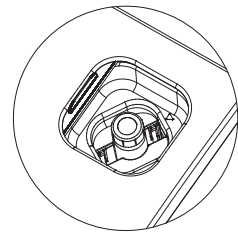

- Insert the cuvette into the holder and close the lid.
- Press the ◀ key to access the timer menu. Press **START** to start Timer 1, the display will show the countdown prior to measurement or wait 3 minutes.
- Press **READ** to start the reading. The instrument displays the results in  $\mu\text{g/L}$  of phosphorus (P).

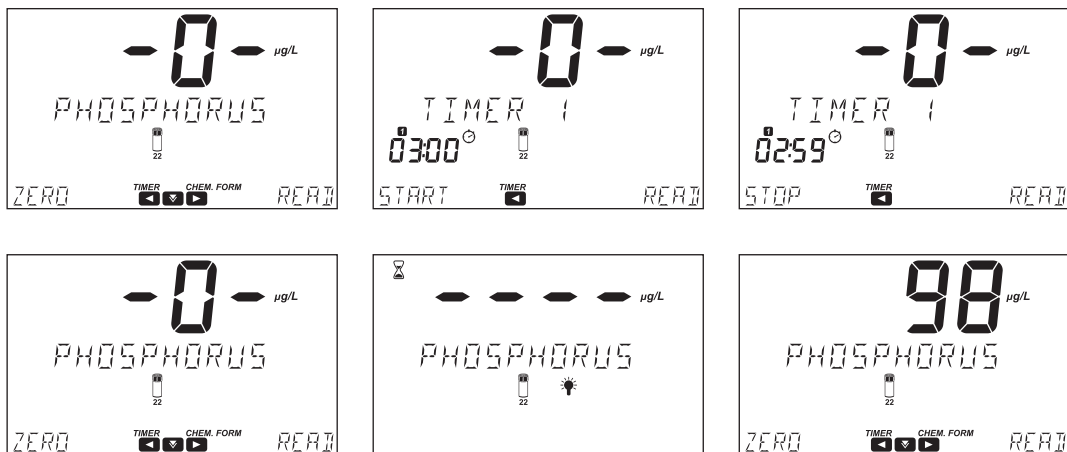

- Press the ▼ key to view the wavelength, method ID, date and time.
- Press the ▶ key to view the chemical formula.
- Press the ▲ key to convert the results to  $\mu\text{g/L}$  of phosphate ( $\text{PO}_4^{3-}$ ) or phosphorus pentoxide ( $\text{P}_2\text{O}_5$ ).

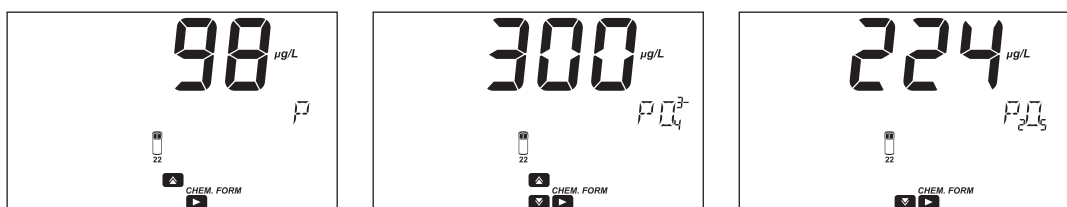

- Press the ▶ key to return to the measurement screen.

## INTERFERENCES

Interference may be caused by:

- Iron, Silica above 50 mg/L
- Copper, Silicate above 10 mg/L
- Hydrogen sulfide, arsenate, turbid sample and highly buffered samples

## Phosphate Low Range

### SPECIFICATIONS

Range	0.00 to 2.50 mg/L (as $\text{PO}_4^{3-}$ )
Resolution	0.01 mg/L
Accuracy	$\pm 0.04$ mg/L $\pm 4\%$ of reading at 25 °C
Wavelength	610 nm
Cuvette type	22 mm diameter
Method	Adaptation of the Ascorbic Acid Method
Method ID	#070

### REQUIRED REAGENTS

Code	Description	Quantity
<a href="#">HI93713-0</a>	Phosphate Low Range Reagent	1 packet

### REAGENT SETS

[HI93713-01](#) Reagents for 100 tests

[HI93713-03](#) Reagents for 300 tests

For other accessories see Accessories section.

### MEASUREMENT PROCEDURE

- Select the **Phosphate LR** method using the procedure described in the Factory Methods section.
- Rinse cuvette, plastic stopper and cap several times with unreacted sample.
- Fill the cuvette with 10 mL of sample (up to the mark). Replace the plastic stopper and the cap.

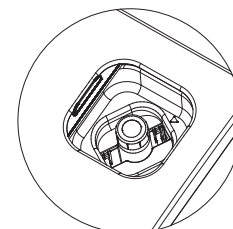

- Insert the cuvette into the holder and close the lid.
- Press **ZERO**. The display will show “-0-” when the meter is zeroed and ready for measurement.

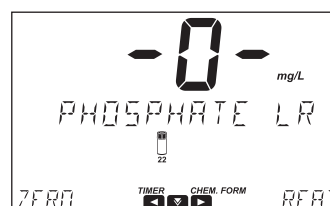
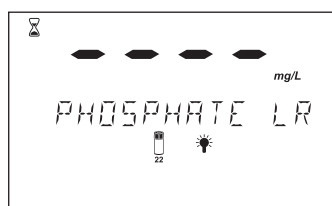
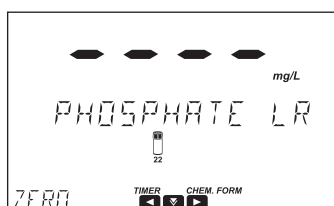

- Remove the cuvette and add one packet of [HI93713-0](#) Phosphate Low Range Reagent. Replace the plastic stopper and the cap. Shake gently (for about 2 minutes) until the powder is completely dissolved.

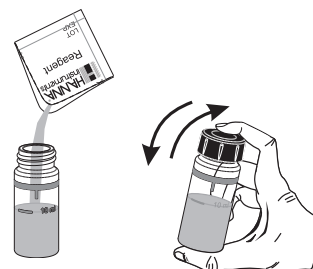

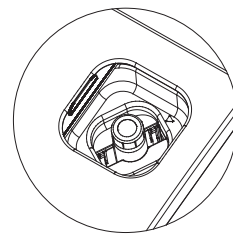

- Insert the cuvette into the holder and close the lid.
- Press the ◀ key to access the timer menu. Press **START** to start Timer 1, the display will show the countdown prior to measurement or wait 3 minutes.
- Press **READ** to start the reading. The instrument displays the results in mg/L of phosphate ( $\text{PO}_4^{3-}$ ).

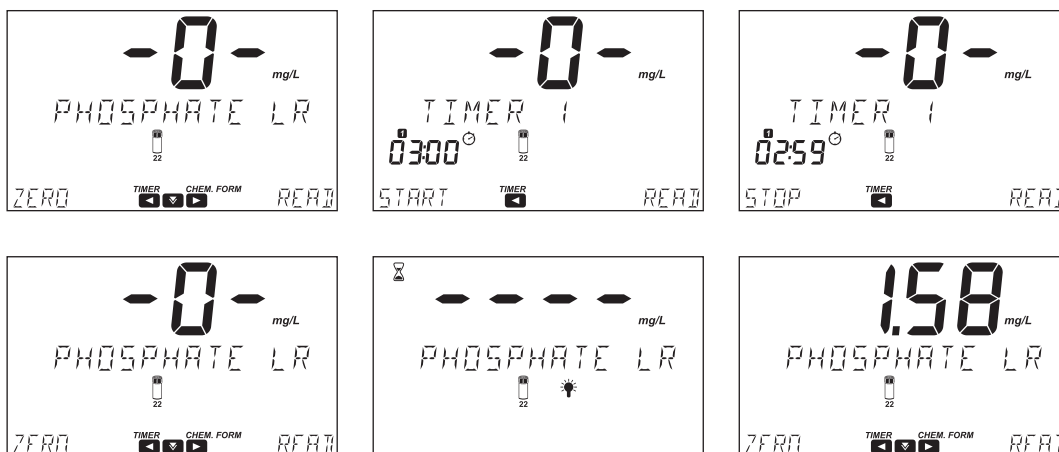

- Press the ▼ key to view the wavelength, method ID, date and time.
- Press the ▶ key to view the chemical formula.
- Press the ▲ key to convert the results to mg/L of phosphorus (P) or phosphorus pentoxide ( $\text{P}_2\text{O}_5$ ).



- Press the ▶ key to return to the measurement screen.

## INTERFERENCES

Interference may be caused by:

- Iron, Silica above 50 mg/L
- Copper, Silicate above 10 mg/L
- Arsenate, Highly buffered samples, Hydrogen sulfide, Turbid samples

## Phosphate High Range

### SPECIFICATIONS

Range	0.0 to 30.0 mg/L (as $\text{PO}_4^{3-}$ )
Resolution	0.1 mg/L
Accuracy	$\pm 1.0$ mg/L $\pm 4\%$ of reading at 25 °C
Wavelength	525 nm
Cuvette type	22 mm diameter
Method	Adaptation of the Standard Methods for the Examination of Water and Wastewater, 18 <sup>th</sup> Edition, Amino Acid Method
Method ID	#071

### REQUIRED REAGENTS

Code	Description	Quantity
HI93717A-0	Phosphate High Range Reagent A	10 drops
HI93717B-0	Phosphate High Range Reagent B	1 packet

### REAGENT SETS

HI93717-01	Reagents for 100 tests
HI93717-03	Reagents for 300 tests

For other accessories see Accessories section.

### MEASUREMENT PROCEDURE

- Select the **Phosphate HR** method using the procedure described in the Factory Methods section.

- Fill the cuvette with 10 mL of unreacted sample (up to the mark). Replace the plastic stopper and the cap.



- Insert the cuvette into the holder and close the lid.

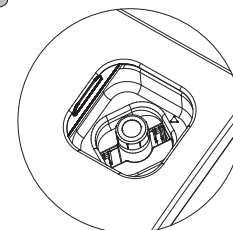

- Press **ZERO**. The display will show “-0-” when the meter is zeroed and ready for measurement.

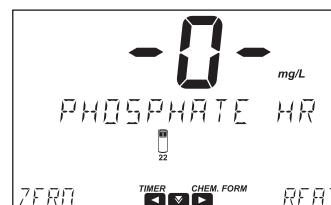
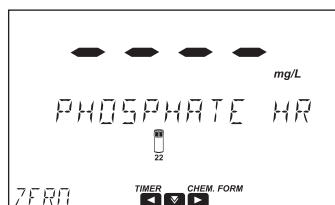

- Add 10 drops of **HI93717A-0** Phosphate High Range Reagent A.



- Add one packet of **HI93717B-0** Phosphate High Range Reagent B to the cuvette. Replace the plastic stopper and the cap. Shake gently until completely dissolved.

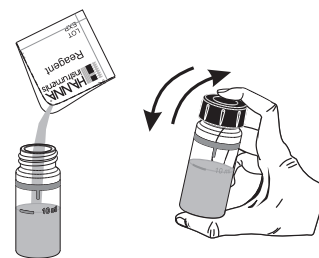

- Insert the cuvette into the holder and close the lid.

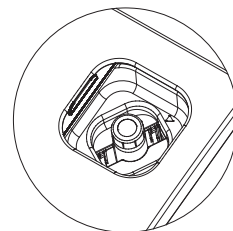

- Press the **◀** key to access the timer menu. Press **START** to start Timer 1, the display will show the countdown prior to measurement or wait 5 minutes.
- Press **READ** to start the reading. The instrument displays the results in **mg/L** of phosphate ( $\text{PO}_4^{3-}$ ).

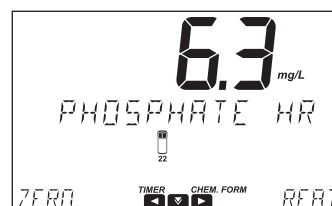
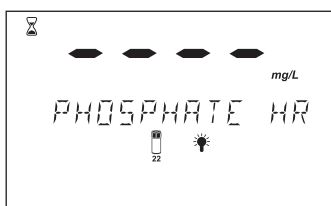
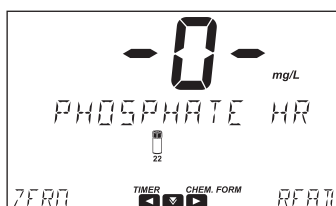
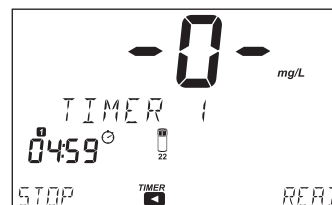
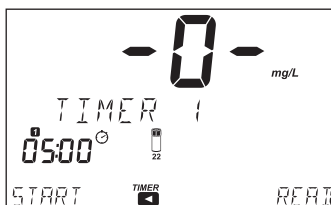

- Press the **▼** key to view the wavelength, method ID, date and time.
- Press the **▶** key to view the chemical formula.
- Press the **▲** key to convert the results to **mg/L** of phosphorus (P) or phosphorus pentoxide ( $\text{P}_2\text{O}_5$ ).

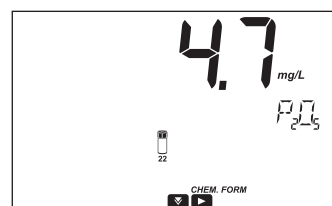
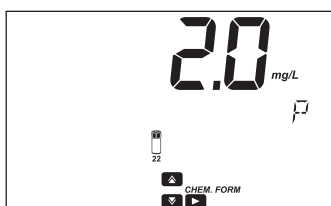
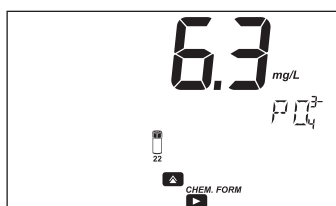

- Press the **▶** key to return to the measurement screen.

## INTERFERENCES

Interference may be caused by:

- Sulfide
- Chloride above 150000 mg/L
- Magnesium above 40000 mg/L  $\text{CaCO}_3$
- Calcium above 10000 mg/L  $\text{CaCO}_3$
- Iron (Ferrous) above 100 mg/L

## Phosphorus, Acid Hydrolyzable (13 mm Vial)

### SPECIFICATIONS

Range	0.00 to 1.60 mg/L (as P)
Resolution	0.01 mg/L
Accuracy	$\pm 0.05$ mg/L or $\pm 5\%$ of reading at 25 °C, whichever is greater
Wavelength	610 nm
Cuvette type	13 mm diameter
Method	Adaptation of the EPA method 365.2 and Standard Methods for the Examination of Water and Wastewater, 20 <sup>th</sup> Edition, 4500-P E, Ascorbic Acid Method
Method ID	#072

### REQUIRED REAGENTS

Code	Description	Quantity
<a href="#">HI93758V-OAH</a> *	Phosphorus Reagent Vial	1 vial
<a href="#">HI93758B-0</a>	NaOH Solution 1.20N	2 mL
<a href="#">HI93758-0</a>	Phosphorous Reagent	1 packet

\* Reagent vial identification: P AH, white label

### REAGENT SETS

[HI93758B-50](#) Reagents for 50 tests

For other accessories see Accessories section.

**Note:** Store the unused vials in their packaging in a cool and dark place.

### MEASUREMENT PROCEDURE



Before using the reagent kit carefully read all the instructions and the Safety Data Sheets (SDS). Pay particular attention to all warnings, cautions and notes. Failure to do so may result in serious injury to the operator.

- Preheat the Hanna<sup>®</sup> Reactor [HI839800](#) to 150 °C (302°F). The optional [HI740217](#) safety shield is strongly recommended.

**Warning:** Do not use an oven or microwave! Samples may leak and generate a corrosive and possibly explosive atmosphere.

- Remove the cap from a [HI93758V-OAH](#) Phosphorus Reagent Vial.
- Add 5 mL of sample to the vial, while keeping the vial at a 45-degree angle.
- Replace the cap. Invert to mix.
- Insert the vial into the reactor and heat it for 30 minutes at 150 °C.

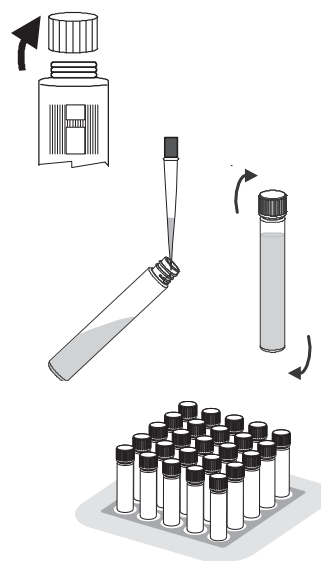

- At the end of the digestion place the vials carefully in the test tube rack and allow to cool to room temperature.

**Warning:** The vials are still hot, use caution when handling.

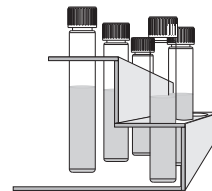

- Select the **Phosphorous Acid Hydro (13 mm)** method using the procedure described in the Factory Methods section.
- Insert the 13 mm vial adapter using the procedure described in the Cuvette & Vial Adapters section.

- Remove the cap from the vial and add 2 mL of **HI93758B-0 NaOH Solution 1.20 N** while keeping the vial at a 45-degree angle.
- Replace the cap. Invert to mix.

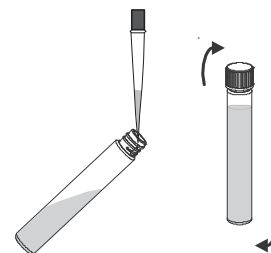

- Insert the vial into the adapter.

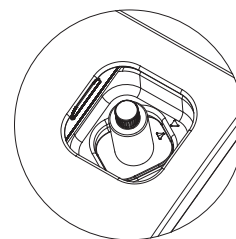

- Press **ZERO**. The display will show “-0-” when the meter is zeroed and ready for measurement.

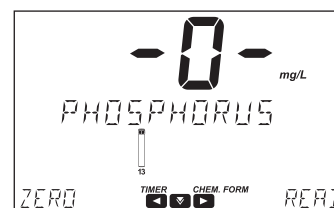
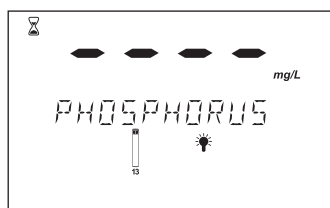
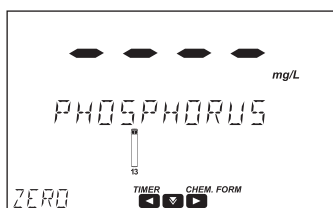

- Remove the vial.
- Remove the cap and add one packet of **HI93758-0 Phosphorus Reagent**.
- Replace the cap. Shake gently for 2 minutes until most of the powder is dissolved.

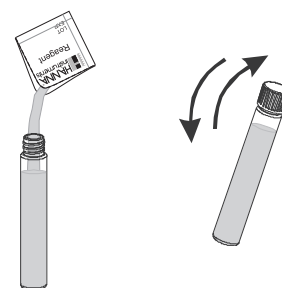

- Insert the vial into the adapter.

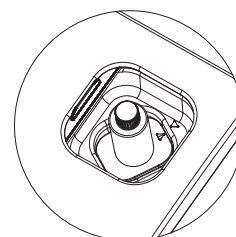



- Press the ◀ key to access the timer menu. Press **START** to start Timer 1, the display will show the countdown prior to measurement or wait 3 minutes.
- Press **READ** to start the reading. The instrument displays the results in mg/L of phosphorus (P).

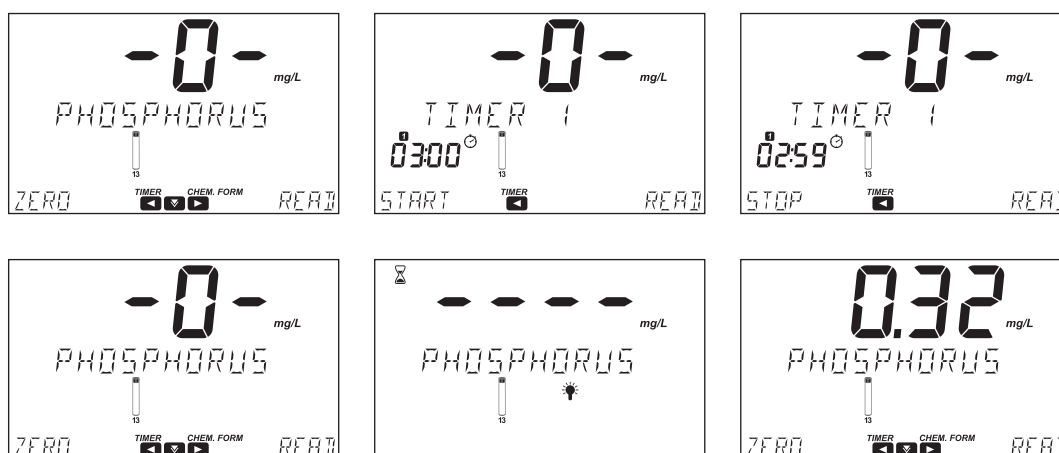

**Note:** The method detects free (orthophosphate) and condensed inorganic forms (meta-, pyro- and other polyphosphates) of phosphates present in the sample.

- Press the ▼ key to view the wavelength, method ID, date and time.
- Press the ▶ key to view the chemical formula.
- Press the ▲ key to convert the results to mg/L of phosphate ( $\text{PO}_4^{3-}$ ) or phosphorus pentoxide ( $\text{P}_2\text{O}_5$ ).

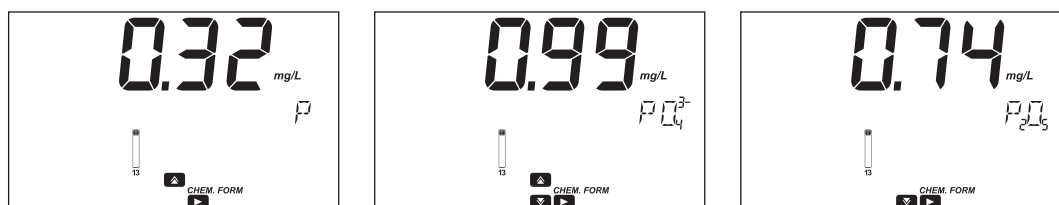

- Press the ▶ key to return to the measurement screen.

## INTERFERENCES

Interference may be caused by:

- Arsenate must be absent
- Silica above 50 mg/L
- Sulfide, to remove the interferent add Bromine Water drop-wise until a pale yellow color develops, remove excess Bromine Water by adding Phenol Solution drop-wise
- Turbidity and suspended matter in large amounts, treat the sample with active carbon and filter, before measuring

## Phosphorus, Reactive Low Range (13 mm Vial)

### SPECIFICATIONS

Range	0.00 to 1.60 mg/L (as P)
Resolution	0.01 mg/L
Accuracy	$\pm 0.05$ mg/L or $\pm 4\%$ of reading at 25 °C, whichever is greater
Wavelength	610 nm
Cuvette type	13 mm diameter
Method	Adaptation of the EPA method 365.2 and Standard Methods for the Examination of Water and Wastewater, 20 <sup>th</sup> Edition, 4500-P E, Ascorbic Acid Method
Method ID	#073

### REQUIRED REAGENTS

Code	Description	Quantity
HI93758A-0*	Phosphorus Reactive Reagent Vial	1 vial
HI93758-0	Phosphorus Reagent	1 packet

\* Reagent vial identification: P R, red label

### REAGENT SETS

HI93758A-50 Reagents for 50 tests

For other accessories see Accessories section.

*Note: Store the unused vials in their packaging in a cool and dark place.*

### MEASUREMENT PROCEDURE

- Select the **Phosphorus Reactive LR (13 mm)** method using the procedure described in the Factory Methods section.
- Insert the 13 mm vial adapter using the procedure described in the Cuvette & Vial Adapters section.
- Remove the cap from HI93758A-0 Phosphorus Reactive Reagent Vial.
- Add 5 mL of sample to the vial, while keeping the vial at a 45-degree angle.
- Replace the cap. Invert several times to mix.
- Insert the vial into the adapter.
- Press **ZERO**. The display will show “-0-” when the meter is zeroed and ready for measurement.

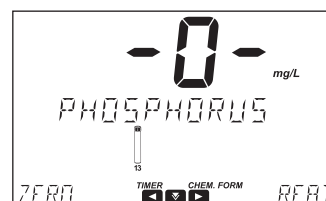
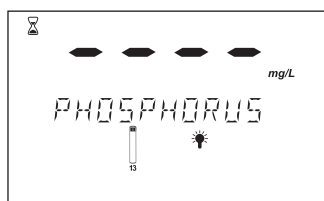
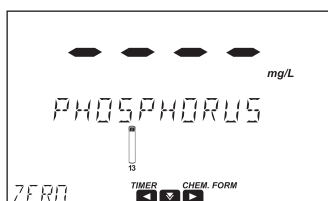
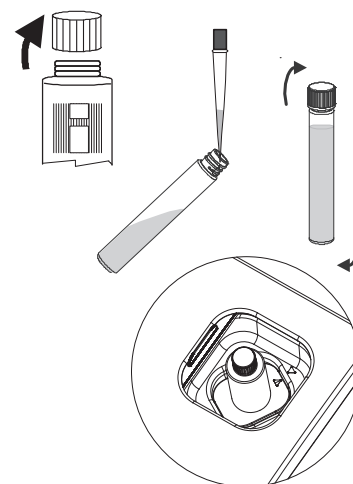

- Remove the vial.
- Remove the cap and add one packet of HI93758-0 Phosphorus Reagent.
- Replace the cap. Shake gently for 2 minutes until most of the powder is dissolved.

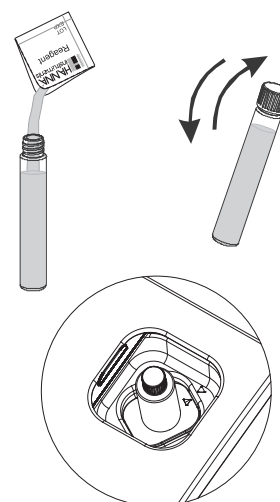

- Insert the vial into the adapter.

- Press the ◀ key to access the timer menu. Press **START** to start Timer 1, the display will show the countdown prior to measurement or wait 3 minutes.
- Press **READ** to start the reading. The instrument displays the results in mg/L of phosphorus (P).

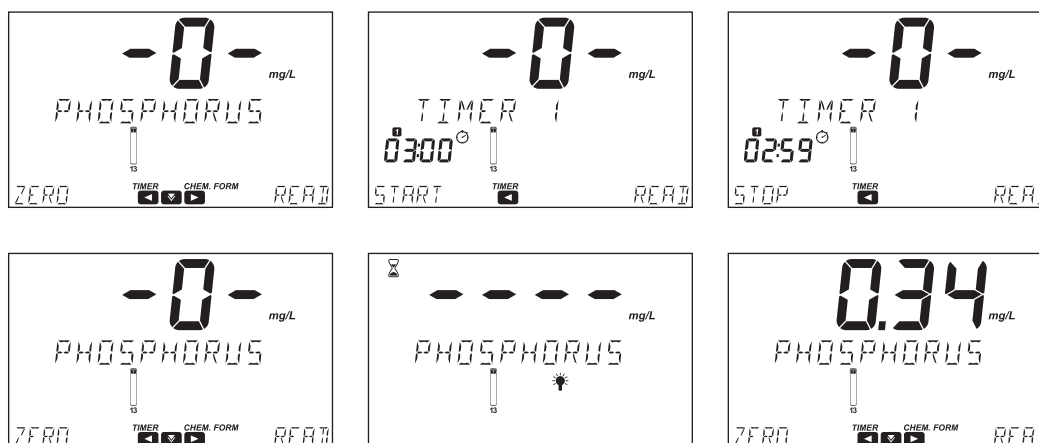

- Press the ▼ key to view the wavelength, method ID, date and time.
- Press the ▶ key to view the chemical formula.
- Press the ▲ key to convert the results to mg/L of phosphate ( $\text{PO}_4^{3-}$ ) or phosphorus pentoxide ( $\text{P}_2\text{O}_5$ ).

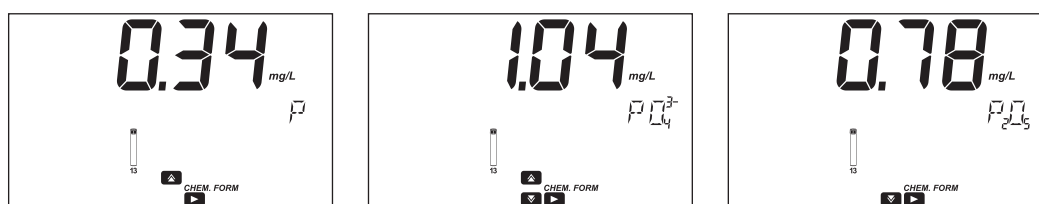

- Press the ▶ key to return to the measurement screen.

## INTERFERENCES

Interference may be caused by:

- Arsenate must be absent
- Silica above 50 mg/L
- Sulfide above 6 mg/L, to remove interference add Bromine Water drop-wise until a pale yellow color develops, to remove excess bromine water add Phenol Solution drop-wise until the solution is clear
- Turbidity and suspended matter in large amounts, treat the sample with active carbon and filter, before measuring

## Phosphorus, Reactive High Range (13 mm Vial)

### SPECIFICATIONS

Range	0.0 to 32.6 mg/L (as P)
Resolution	0.1 mg/L
Accuracy	$\pm 0.5$ mg/L or $\pm 4\%$ of reading at 25 °C, whichever is greater
Wavelength	420 nm
Cuvette type	13 mm diameter
Method	Adaptation of the Standard Methods for the Examination of Water and Wastewater, 20 <sup>th</sup> Edition, 4500-P C, Vanadomolybdophosphoric Acid Method
Method ID	#074

### REQUIRED REAGENTS

Code	Description	Quantity
HI93763A-0*	Phosphorus Reactive High Range Reagent Vial	2 vials
DEIONIZED120	Deionized Water	5 mL

\*Reagent vial identification: P RHR, green label

### REAGENT SETS

HI93763A-50 Reagents for up to 49 tests

For other accessories see Accessories section.

*Note: Store the unused vials in their packaging in a cool and dark place.*

### MEASUREMENT PROCEDURE

**Reagent Blank Correction:** This method requires a reagent blank correction. A single blank vial may be used more than once; the blank vial is stable up to two weeks (room temperature). For improved accuracy always use the same lot of reagents for the blank and sample, and run a blank for each set of measurements.

- Select the **Phosphorus Reactive HR (13 mm)** method using the procedure described in the Factory Methods section.
- Insert the 13 mm vial adapter using the procedure described in the Cuvette & Vial Adapters section.
- Remove the cap from two HI93763A-0 Phosphorus Reactive High Range Reagent Vials.

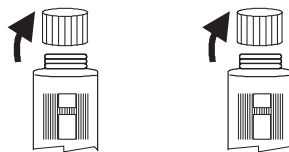

- Add 5 mL of deionized water to the first vial (#1) and 5 mL of sample to the second vial (#2), while keeping the vials at a 45-degree angle.
- Replace the cap. Invert several times to mix.

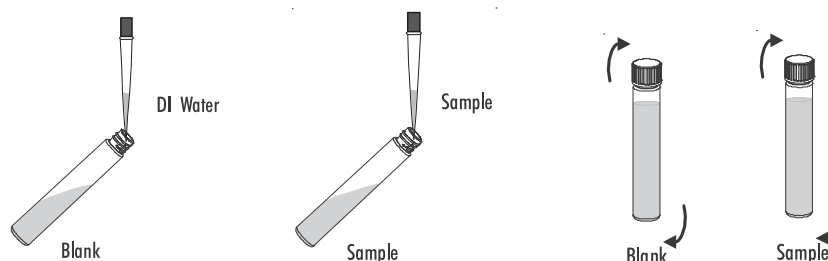

#1

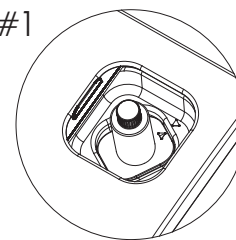

- Insert the blank vial (#1) into the adapter.
- Press the ◀ key to access the timer menu. Press **START** to start Timer 1, the display will show the countdown prior to the zero or wait 7 minutes.
- Press **ZERO**. The display will show “-0-” when the meter is zeroed and ready for measurement.

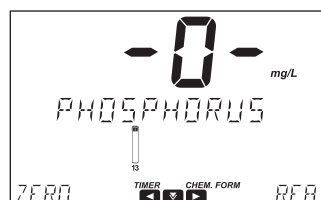
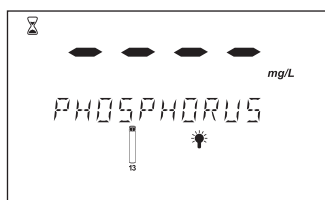
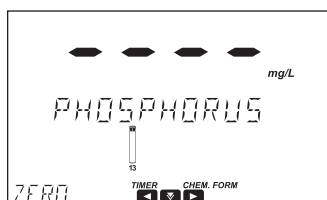
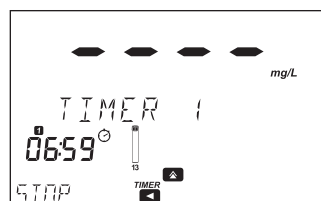
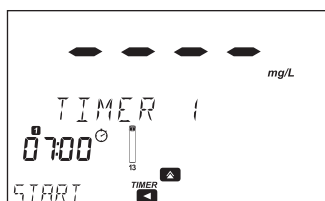
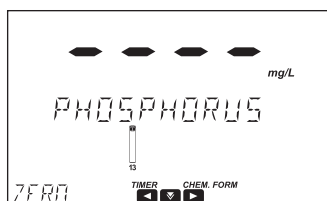

- Remove the blank vial.
- Insert the sample vial (#2) into the adapter.

#2

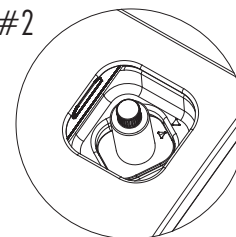

- Press **READ** to start the measurement. The instrument displays the results in mg/L of phosphorus (P).

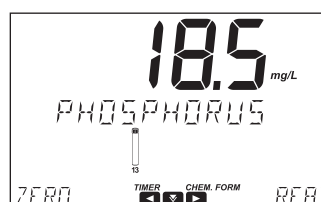
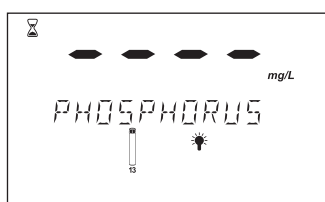
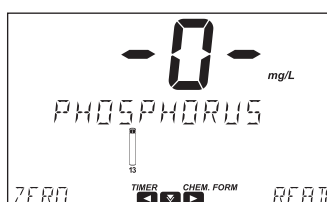

- Press the ▼ key to view the wavelength, method ID, date and time.
- Press the ▶ key to view the chemical formula.
- Press the ▲ key to convert the results to mg/L of phosphate ( $\text{PO}_4^{3-}$ ) or phosphorus pentoxide ( $\text{P}_2\text{O}_5$ ).

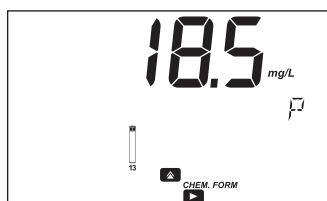

- Press the ▶ key to return to the measurement screen.

## INTERFERENCES

Interference may be caused by:

- Bismuth, Fluoride
- The sample should have a neutral pH
- Sulfide, to remove the interferent add Bromine Water drop-wise until a pale yellow color develops, remove excess Bromine Water by adding Phenol Solution drop-wise
- The method is temperature sensitive. It is recommended to run measurements at 20 to 25 °C, temperatures below 20 °C cause a negative error, temperatures above 25 °C cause a positive error
- Turbidity and suspended matter in large amounts, treat the sample with active carbon and filter before measuring

## Phosphorus, Total Low Range (13 mm Vial)

### SPECIFICATIONS

Range	0.00 to 1.60 mg/L (as P)
Resolution	0.01 mg/L
Accuracy	$\pm 0.05$ mg/L or $\pm 5\%$ of reading at 25 °C, whichever is greater
Wavelength	610 nm
Cuvette type	13 mm diameter
Method	Adaptation of the EPA method 365.2 and Standard Methods for the Examination of Water and Wastewater, 20 <sup>th</sup> Edition, 4500-P E, Ascorbic Acid Method
Method ID	#075

### REQUIRED REAGENTS

Code	Description	Quantity
HI93758V-0*	Phosphorus Reagent Vial	1 vial
HI93758C-0	NaOH solution 1.54N	2 mL
HI93758-0	Phosphorus Reagent	1 packet
PERSULFATE/P	Potassium Persulfate	1 packet

\* Reagent vial identification: P TLR, red label

### REAGENT SETS

HI93758C-50 Reagents for 50 tests

For other accessories see Accessories section.

**Note:** Store the unused vials in their packaging in a cool and dark place.

### MEASUREMENT PROCEDURE



Before using the reagent kit carefully read all the instructions and the Safety Data Sheets (SDS). Pay particular attention to all warnings, cautions and notes. Failure to do so may result in serious injury to the operator.

- Preheat the Hanna<sup>®</sup> Reactor HI839800 to 150 °C (302°F). The optional HI740217 safety shield is strongly recommended.

**Warning:** Do not use an oven or microwave, samples may leak and generate a corrosive and possibly explosive atmosphere.

- Remove the cap from a HI93758V-0 Reagent Vial.
- Add 5 mL of sample to the vial, while keeping the vial at a 45-degree angle.
- Add one packet of PERSULFATE/P Potassium Persulfate. Replace the cap. Shake gently the vial until all the powder is completely dissolved.

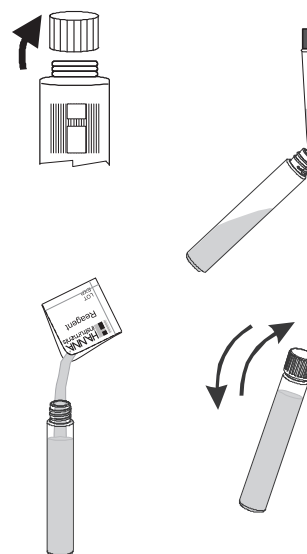

- Insert the vial into the reactor and heat it for 30 minutes at 150 °C.



- At the end of the digestion place the vials carefully in the test tube rack and allow to cool to room temperature.

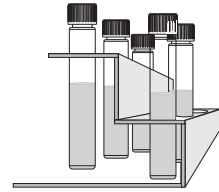

**Warning:** The vials are still hot, use caution when handling.

- Select the **Phosphorus Total LR (13 mm)** method using the procedure described in the Factory Methods section.
- Insert the 13 mm vial adapter using the procedure described in the **Cuvette & Vial Adapters** section.

- Remove the cap from the vial and add exactly 2 mL of **HI93758C-0** NaOH Solution 1.54 N, while keeping the vial at a 45-degree angle.
- Replace the cap. Invert the vial several times to mix.

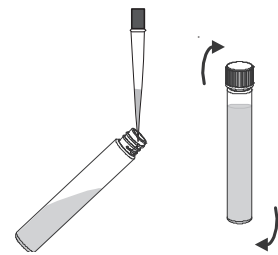

- Insert the vial into the adapter.

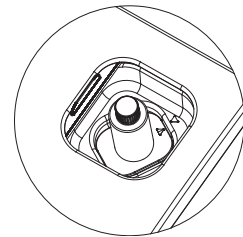

- Press **ZERO**. The display will show “-0-” when the meter is zeroed and ready for measurement.

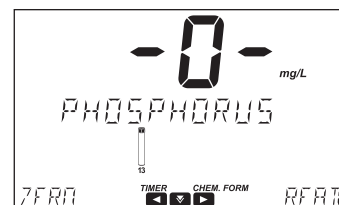
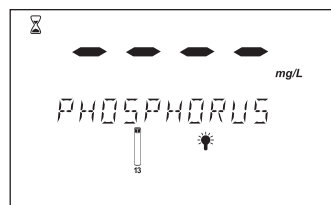
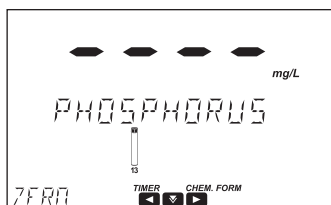

- Remove the vial.
- Remove the cap and add one packet of **HI93758-0** Phosphorus Reagent.
- Replace the cap. Shake for 2 minutes until the powder is completely dissolved.

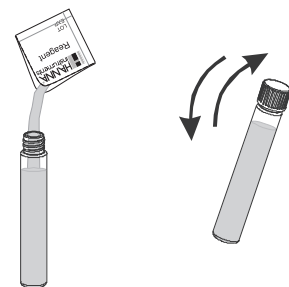

- Insert the vial into the adapter.

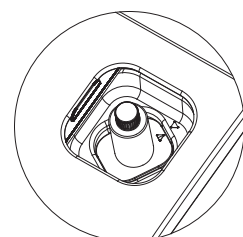



- Press the ◀ key to access the timer menu. Press **START** to start Timer 1, the display will show the countdown prior to measurement or wait 3 minutes.
- Press **READ** to start the reading. The instrument displays the results in mg/L of phosphorus (P).

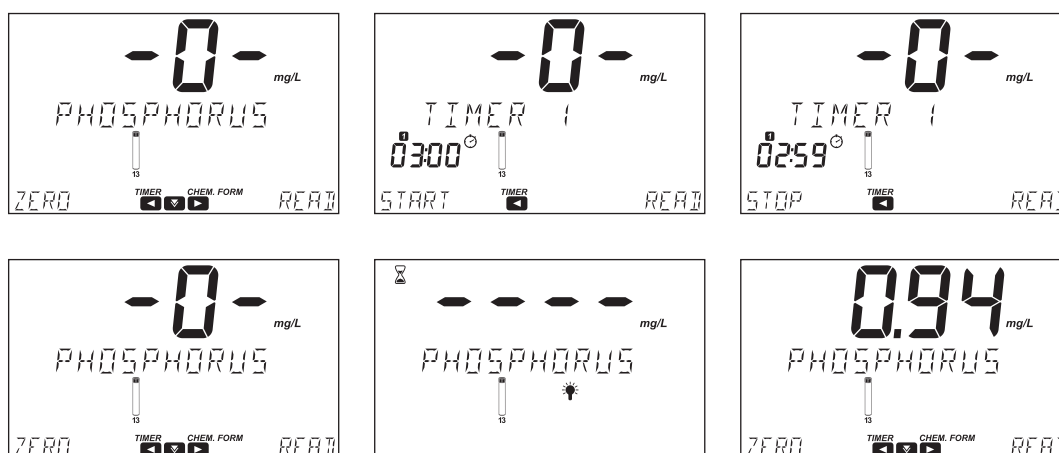

**Note:** The method detects free (orthophosphate) and condensed inorganic forms (meta-, pyro- and other polyphosphates) of phosphates present in the sample.

- Press the ▼ key to view the wavelength, method ID, date and time.
- Press the ▶ key to view the chemical formula.
- Press the ▲ key to convert the results to mg/L of phosphate ( $\text{PO}_4^{3-}$ ) or phosphorus pentoxide ( $\text{P}_2\text{O}_5$ ).

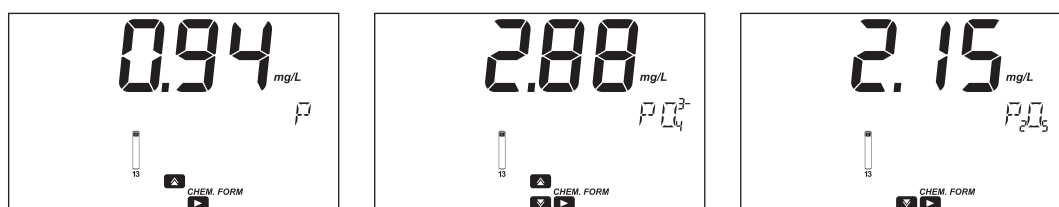

- Press the ▶ key to return to the measurement screen.

## INTERFERENCES

Interference may be caused by:

- Arsenate must be absent
- Silica above 50 mg/L
- Sulfide, to remove the interferent add Bromine Water drop-wise until a pale yellow color develops, remove excess Bromine Water by adding Phenol Solution drop-wise
- Turbidity and suspended matter in large amounts, treat the sample with active carbon and filter, before measuring

## Phosphorus, Total High Range (13 mm Vial)

### SPECIFICATIONS

Range	0.0 to 32.6 mg/L (as P)
Resolution	0.1 mg/L
Accuracy	$\pm 0.5$ mg/L or $\pm 5\%$ of reading at 25 °C, whichever is greater
Wavelength	420 nm
Cuvette type	13 mm diameter
Method	Adaptation of the Standard Methods for the Examination of Water and Wastewater, 20 <sup>th</sup> Edition, 4500-P C, Vanadomolybdophosphoric Acid Method
Method ID	#076

### REQUIRED REAGENTS

Code	Description	Quantity
HI93758V-OHR*	Phosphorus Reagent Vial	2 vials
HI93758C-0	NaOH solution 1.54N	4 mL
HI93763B-0	Total Phosphorous High Range Reagent B	1 mL
DEIONIZED120	Deionized Water	5 mL
PERSULFATE/P	Potassium Persulfate	2 packets

\*Reagent vial identification: P THR, green label

### REAGENT SETS

HI93763B-50 Reagents for up to 49 tests

For other accessories see Accessories section.

**Note:** Store the unused vials in their packaging in a cool and dark place.

### MEASUREMENT PROCEDURE



Before using the reagent kit carefully read all the instructions and the Safety Data Sheets (SDS). Pay particular attention to all warnings, cautions and notes. Failure to do so may result in serious injury to the operator.

**Reagent Blank Correction:** This method requires a reagent blank correction. A single blank vial may be used more than once. The blank vial is stable for one day at room temperature.

- Preheat the Hanna<sup>®</sup> Reactor HI839800 to 150 °C (302 °F). The optional HI740217 safety shield is strongly recommended.

**Warning:** Do not use an oven or microwave, samples may leak and generate a corrosive and possibly explosive atmosphere.

- Remove the cap from two HI93758V-OHR Phosphorus Reagent Vials.

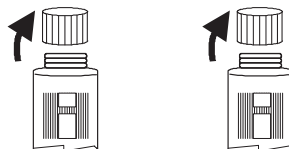

- Add 5 mL of deionized water to the first vial (#1) and 5 mL of sample to the second vial (#2), while keeping the vials at a 45-degree angle.

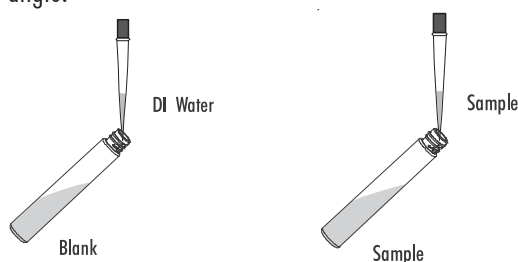

- Add one packet of **PERFSULFATE/P** Potassium Persulfate to each vial. Replace the cap. Shake gently until all the powder is completely dissolved.

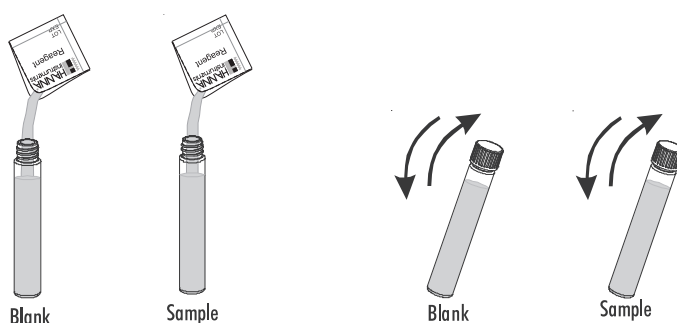

- Insert the vials into the reactor and heat them for 30 minutes at 150 °C.



- At the end of the digestion place the vials carefully in the test tube rack and allow to cool to room temperature.

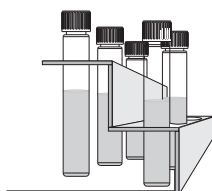

**Warning:** The vials are still hot, use caution when handling.

- Select the **Phosphorus Total HR (13 mm)** method using the procedure described in the Factory Methods section.
- Insert the 13 mm vial adapter using the procedure described in the Cuvette & Vial Adapters section.
- Remove the cap from the vials and add 2 mL of **HI93758C-0** NaOH Solution 1.54N to each vial, while keeping the vials at a 45-degree angle. Replace the cap tightly. Invert the vials several times to mix.

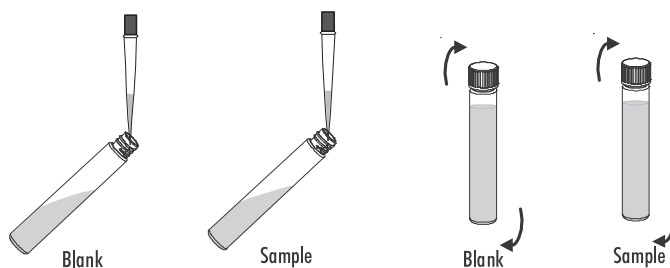

- Remove the cap from the vials and add 0.5 mL of **HI93763B-0** Total Phosphorus High Range Reagent B to each vial, while keeping the vial at a 45-degree angle. Replace the cap. Invert several times to mix.

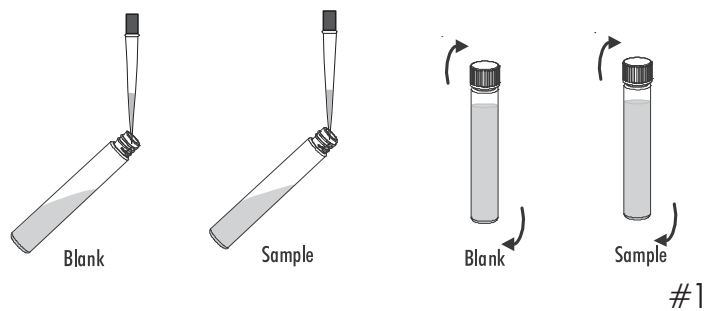

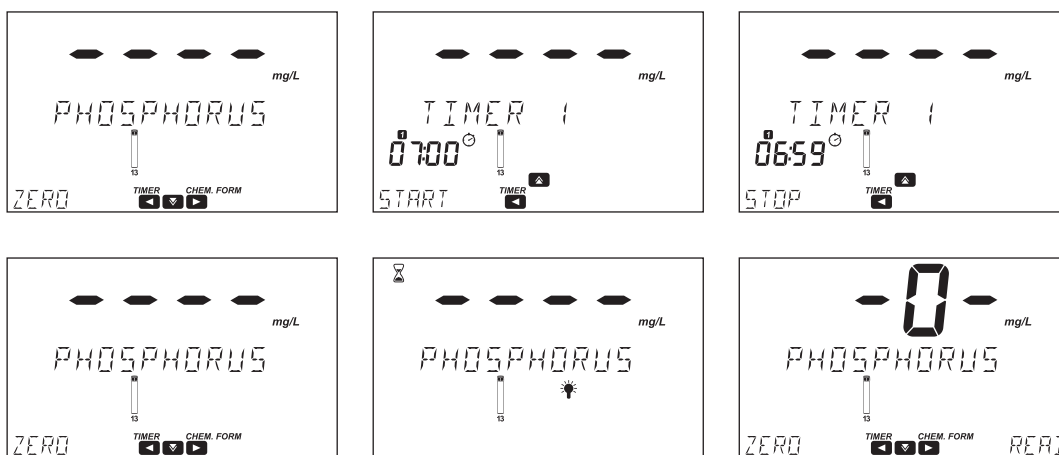

- Insert the blank vial (#1) into the adapter.
- Press the key to access the timer menu. Press **START** to start Timer 1, the display will show the countdown prior to the zero or wait 7 minutes.
- Press **ZERO**. The display will show “-0-” when the meter is zeroed and ready for measurement.

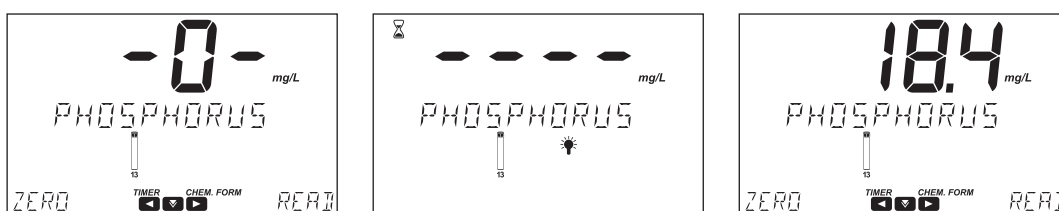

- Remove the blank vial.
- Insert the sample vial (#2) into the adapter.
- Press **READ** to start the reading. The instrument displays the results in mg/L of phosphorus (P).



**Note:** The method detects free (orthophosphate), condensed inorganic forms (meta-, pyro- and other polyphosphates) and organic forms of phosphates present in the sample.

- Press the  key to view the wavelength, method ID, date and time.
- Press the  key to view the chemical formula.
- Press the  key to convert the results to mg/L of phosphate ( $\text{PO}_4^{3-}$ ) or phosphorus pentoxide ( $\text{P}_2\text{O}_5$ ).

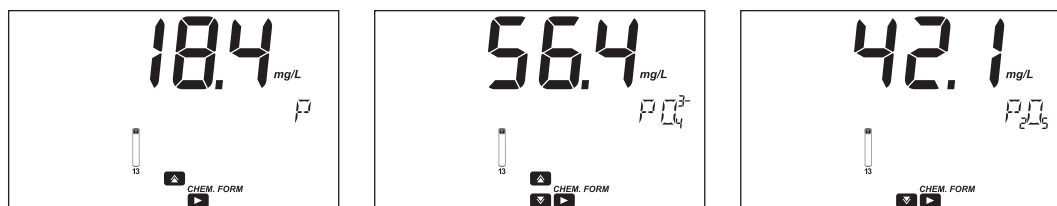

- Press the  key to return to the measurement screen.

### INTERFERENCES

Interference may be caused by:

- Arsenate
- The sample should have a neutral pH
- The method is temperature sensitive. It is recommended to add the Molybdovanadate Reagent and to run measurements at 20 to 25 °C, temperatures below 20 °C cause a negative error, temperatures above 25 °C cause a positive error
- Turbidity and suspended matter in large amounts, treat the sample with active carbon and filter before measuring

## Potassium Low Range

### SPECIFICATIONS

Range	0.0 to 20.0 mg/L (as K)
Resolution	0.1 mg/L
Accuracy	$\pm 2$ mg/L $\pm 7\%$ of reading at 25 °C
Wavelength	466 nm
Cuvette type	22 mm diameter
Method	Adaptation of the Turbidimetric Tetraphenylborate Method
Method ID	#077

### REQUIRED REAGENTS

Code	Description	Quantity
HI93750A-0	Potassium Reagent A	6 drops
HI93750B-0	Potassium Reagent B	1 packet

### REAGENT SETS

HI93750-01	Reagents for 100 tests
HI93750-03	Reagents for 300 tests

For other accessories see Accessories section.

### MEASUREMENT PROCEDURE

- Select the **Potassium LR** method using the procedure described in the Factory Methods section.

- Fill the cuvette with 10 mL of sample (up to the mark).

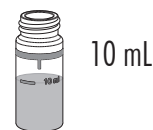

- Add 6 drops of **HI93750A-0** Potassium Reagent A. Replace the plastic stopper and the cap. Invert 5 times to mix the solution.

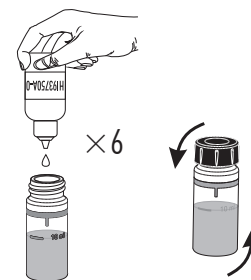

- Insert the cuvette into the holder and close the lid.

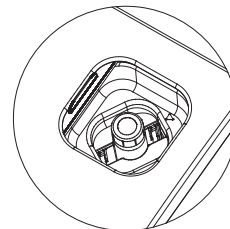

- Press **ZERO**. The display will show “-0-” when the meter is zeroed and ready for measurement.

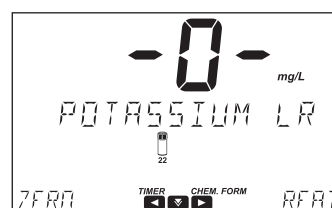
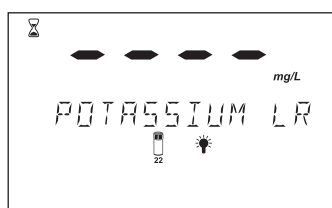
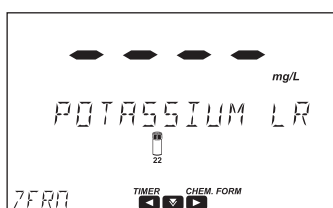

- Add one packet of **HI93750B-0** Potassium Reagent B. Replace the plastic stopper and the cap. Shake gently for 1 minute.

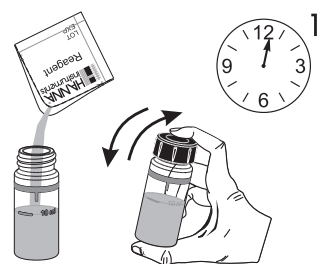

- Insert the cuvette into the holder and close the lid.

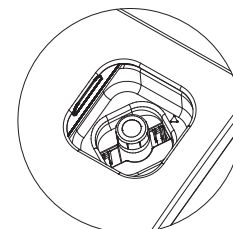

- Press the **◀** key to access the timer menu. Press **START** to start Timer 1, the display will show the countdown prior to measurement or wait 3 minutes. After the 3 minutes have passed, invert the cuvette 5 times to mix. Insert the cuvette into the holder and close the lid.
- Press **READ** to start the reading. The instrument displays the results in **mg/L of potassium (K)**.

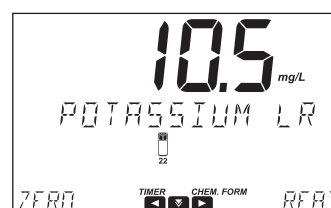
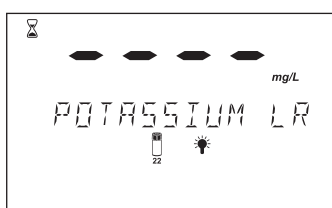
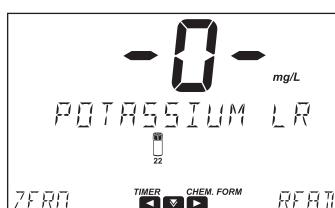
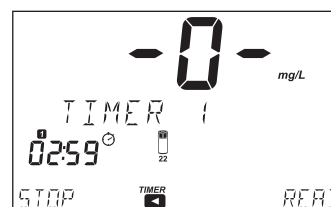
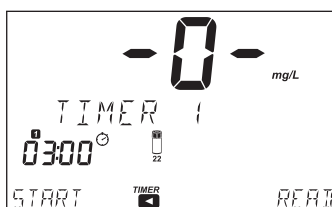
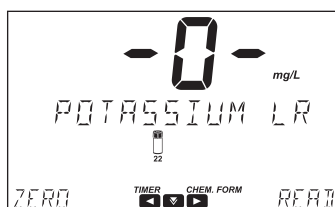

- Press the **▼** key to view the wavelength, method ID, date and time.
- Press the **▶** key to view the chemical formula.
- Press the **▲** key to convert the results to **mg/L of potassium oxide (K<sub>2</sub>O)**.

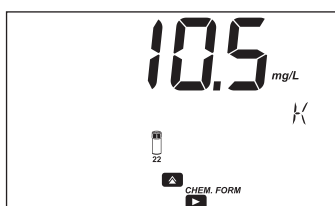

- Press the **▶** key to return to the measurement screen.

## INTERFERENCES

Interferences may be caused by:

- Chloride above 12000 mg/L
- Calcium above 10000 mg/L CaCO<sub>3</sub>
- Magnesium above 8000 mg/L CaCO<sub>3</sub>
- Sodium above 8000 mg/L
- Ammonium above 10 mg/L

## Potassium Medium Range

### SPECIFICATIONS

Range	10 to 100 mg/L (as K)
Resolution	1 mg/L
Accuracy	$\pm 10$ mg/L $\pm 7\%$ of reading at 25 °C
Wavelength	466 nm
Cuvette type	22 mm diameter
Method	Adaptation of the Turbidimetric Tetraphenylborate Method
Method ID	#078

### REQUIRED REAGENTS

Code	Description	Quantity
HI93750A-0	Potassium Reagent A	6 drops
HI93750B-0	Potassium Reagent B	1 packet

### REAGENT SETS

HI93750-01	Reagents for 100 tests
HI93750-03	Reagents for 300 tests

For other accessories see Accessories section.

### MEASUREMENT PROCEDURE

- Select the **Potassium MR** method using the procedure described in the Factory Methods section.
- Sample Dilution: In a 100 mL volumetric flask accurately add 20 mL of sample and bring to volume with deionized water. This is the sample.
- Fill the cuvette with 10 mL of sample (up to the mark).

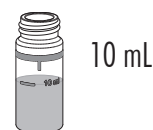

- Add 6 drops of **HI93750A-0** Potassium Reagent A. Replace the plastic stopper and the cap. Invert 5 times to mix the solution.

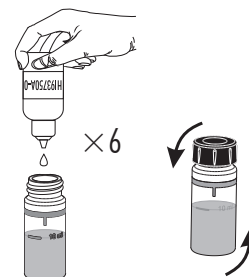

- Insert the cuvette into the holder and close the lid.
- Press **ZERO**. The display will show “-0-” when the meter is zeroed and ready for measurement.

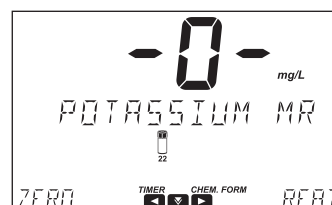
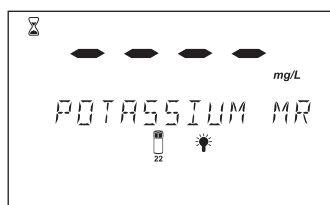
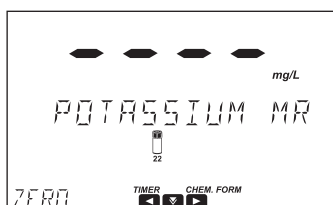
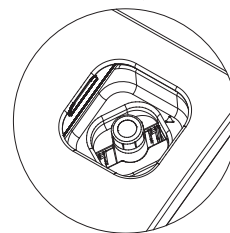



- Add one packet of **HI93750B-0** Potassium Reagent B. Replace the plastic stopper and the cap. Shake gently for 1 minute.

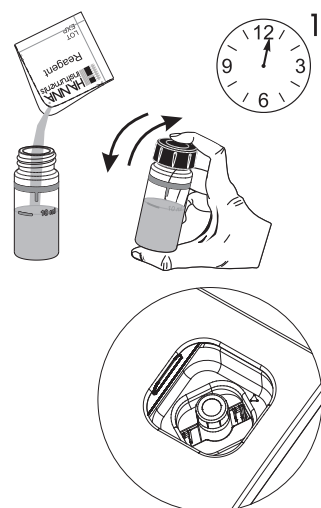

- Insert the cuvette into the holder and close the lid.
- Press the **◀** key to access the timer menu. Press **START** to start Timer 1, the display will show the countdown prior to measurement or wait 3 minutes. After the 3 minutes have passed, invert the cuvette 5 times to mix. Insert the cuvette into the holder and close the lid.
- Press **READ** to start the reading. The instrument displays the results in **mg/L of potassium (K)**.

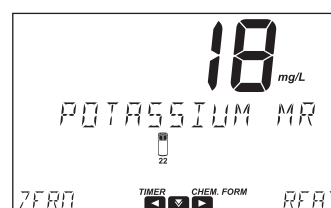
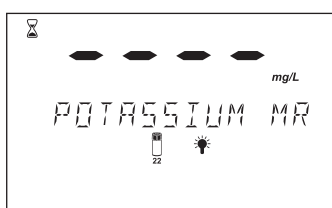
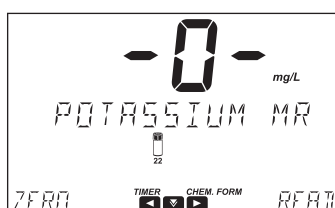
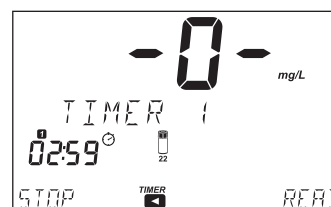
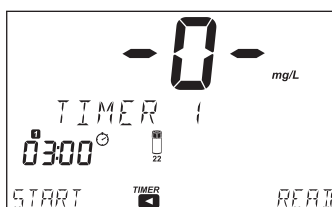
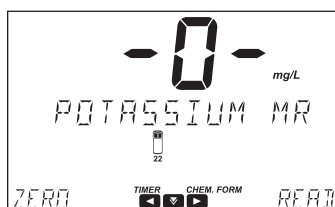

- Press the **▼** key to view the wavelength, method ID, date and time.
- Press the **▶** key to view the chemical formula.
- Press the **▲** key to convert the results to **mg/L of potassium oxide (K<sub>2</sub>O)**.

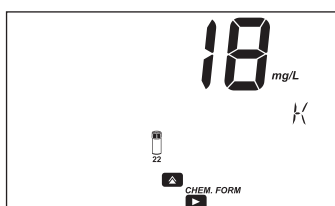

- Press the **▶** key to return to the measurement screen.

## INTERFERENCES

Interferences may be caused by:

- Chloride above 12000 mg/L
- Calcium above 10000 mg/L CaCO<sub>3</sub>
- Magnesium above 8000 mg/L CaCO<sub>3</sub>
- Sodium above 8000 mg/L
- Ammonium above 10 mg/L

## Potassium High Range

### SPECIFICATIONS

Range	20 to 200 mg/L (as K)
Resolution	1 mg/L
Accuracy	$\pm 20$ mg/L $\pm 7\%$ of reading at 25 °C
Wavelength	466 nm
Cuvette type	22 mm diameter
Method	Adaptation of the Turbidimetric Tetraphenylborate Method
Method ID	#079

### REQUIRED REAGENTS

Code	Description	Quantity
HI93750A-0	Potassium Reagent A	6 drops
HI93750B-0	Potassium Reagent B	1 packet

### REAGENT SETS

HI93750-01 Reagents for 100 tests

HI93750-03 Reagents for 300 tests

For other accessories see Accessories section.

### MEASUREMENT PROCEDURE

- Select the **Potassium HR** method using the procedure described in the Factory Methods section.
- Sample Dilution: In a 100 mL volumetric flask accurately add 10 mL of sample and bring to volume with deionized water. This is the sample.
- Fill the cuvette with 10 mL of sample (up to the mark).

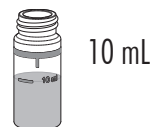

- Add 6 drops of **HI93750A-0** Potassium Reagent A. Replace the plastic stopper and the cap. Invert 5 times to mix the solution.

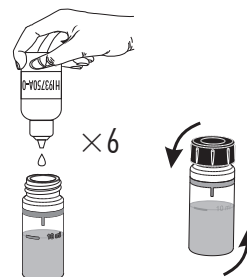

- Insert the cuvette into the holder and close the lid.

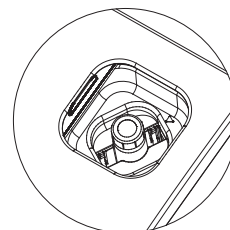

- Press **ZERO**. The display will show “-0-” when the meter is zeroed and ready for measurement.

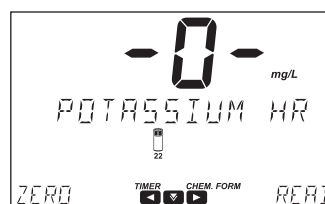
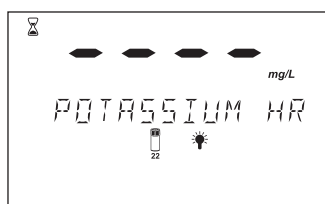
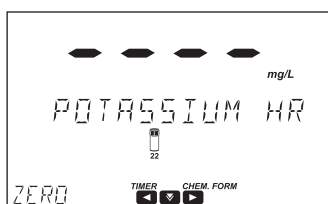

- Add one packet of **HI93750B-0** Potassium Reagent B. Replace the plastic stopper and the cap. Shake gently for 1 minute.

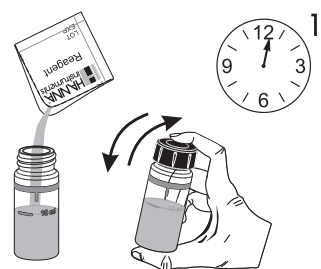

- Insert the cuvette into the holder and close the lid.

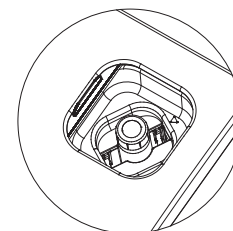

- Press the **◀** key to access the timer menu. Press **START** to start Timer 1, the display will show the countdown prior to measurement or wait 3 minutes. After the 3 minutes have passed, invert the cuvette 5 times to mix. Insert the cuvette into the holder and close the lid.
- Press **READ** to start the reading. The instrument displays the results in **mg/L of potassium (K)**.

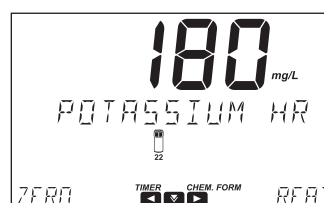
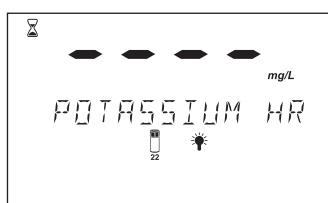
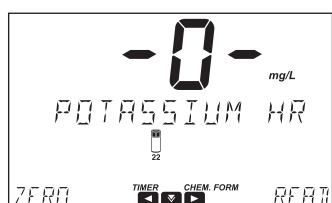
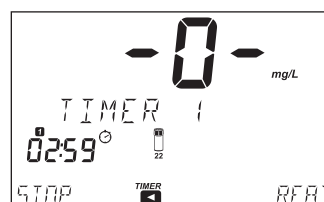
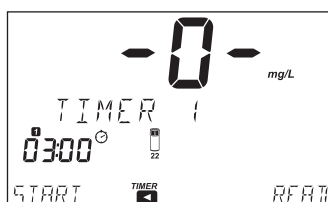
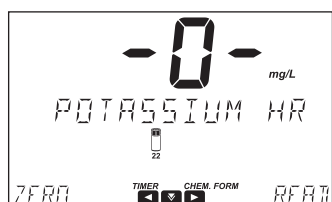

- Press the **▼** key to view the wavelength, method ID, date and time.
- Press the **▶** key to view the chemical formula.
- Press the **▲** key to convert the results to **mg/L of potassium oxide (K<sub>2</sub>O)**.

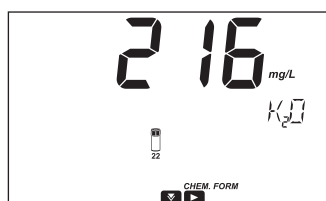
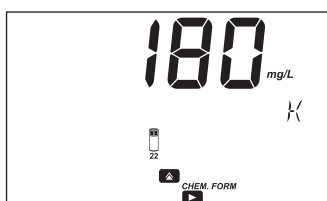

- Press the **▶** key to return to the measurement screen.

## INTERFERENCES

Interferences may be caused by:

- Chloride above 12000 mg/L
- Calcium above 10000 mg/L CaCO<sub>3</sub>
- Magnesium above 8000 mg/L CaCO<sub>3</sub>
- Sodium above 8000 mg/L
- Ammonium above 10 mg/L

## Silica Low Range

### SPECIFICATIONS

Range	0.00 to 2.00 mg/L (as SiO <sub>2</sub> )
Resolution	0.01 mg/L
Accuracy	±0.03 mg/L ± 5% of reading at 25 °C
Wavelength	610 nm
Cuvette type	22 mm diameter
Method	Adaptation of the ASTM Manual of Water and Environmental Technology, D859, Heteropoly Molybdenum Blue Method
Method ID	#080

### REQUIRED REAGENTS

Code	Description	Quantity
HI93705A-0	Silica Low Range Reagent A	6 drops
HI93705B-0	Silica Low Range Reagent B	1 packet
HI93705C-0	Silica Low Range Reagent C	1 packet

### REAGENT SETS

HI93705-01	Reagents for 100 tests
HI93705-03	Reagents for 300 tests

For other accessories see Accessories section.

### MEASUREMENT PROCEDURE

- Select the **Silica LR** method using the procedure described in the Factory Methods section.

- Fill the cuvette with 10 mL of unreacted sample (up to the mark).



10 mL

- Add 6 drops of **HI93705A-0** Silica Low Range Reagent A. Replace the plastic stopper and the cap. Swirl the solution.

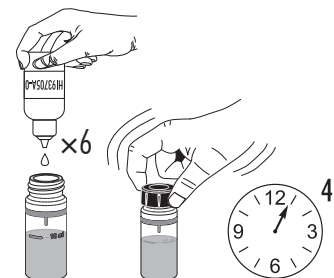

- Press the ◀ key to access the timer menu. Press **START** to start Timer 1, the display will show the countdown prior to adding **HI93705B-0** Silica Low Range Reagent B or wait 4 minutes.

- Add one packet of **HI93705B-0** Silica Low Range Reagent B. Replace the plastic stopper and the cap. Shake until it is completely dissolved.

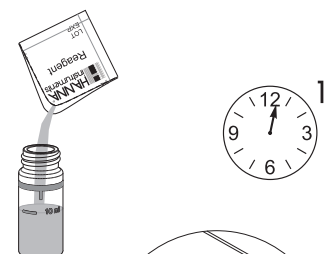

- Press the ◀ key to access the timer menu, press the ▲ key to select Timer 2. Press **START** to start Timer 2, the display will show the countdown or wait 1 minute.

- Insert the cuvette into the holder and close the lid.

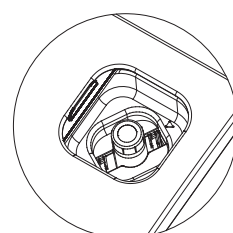

- Press **ZERO**. The display will show “-0-” when the meter is zeroed and ready for measurement.

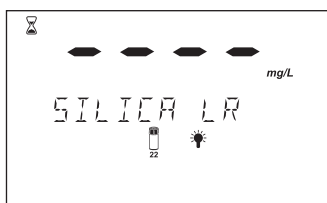
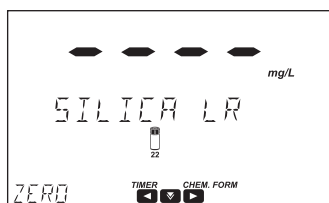

- Remove the cuvette.
- Add one packet of **HI93705C-0** Silica Low Range Reagent C. Replace the plastic stopper and the cap. Shake until it is completely dissolved.

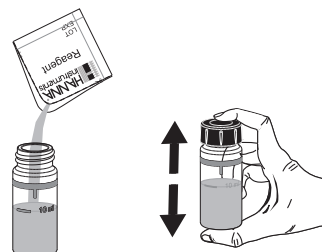

- Insert the cuvette into the holder and close the lid.

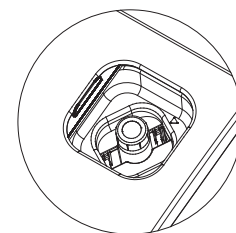

- Press the **◀** key to access the timer menu, press the **▲** key to select Timer 3. Press **START** to start Timer 3, the display will show the countdown prior to measurement or wait 3 minutes.
- Press **READ** to start the reading. The instrument displays the results in **mg/L of silica (SiO<sub>2</sub>)**.

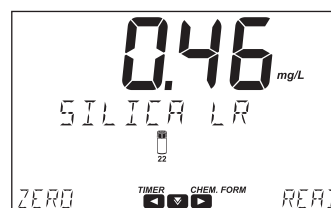
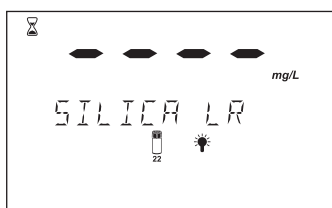
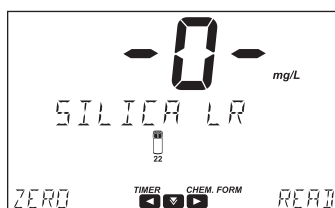
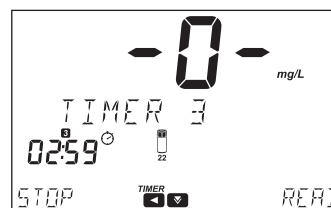
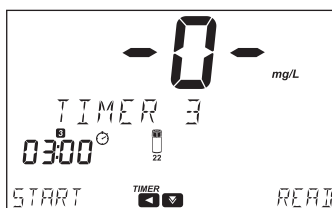
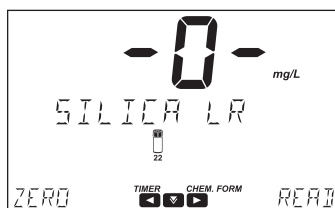

- Press the **▼** key to view the wavelength, method ID, date and time.
- Press the **▶** key to view the chemical formula.
- Press the **▲** key to convert the results to **mg/L of silicon (Si)**.

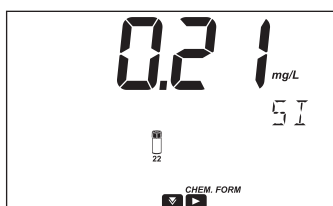
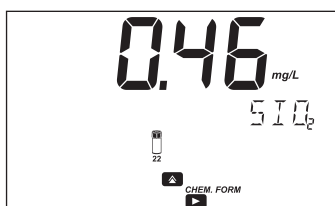

- Press the **▶** key to return to the measurement screen.

## INTERFERENCES

Interference may be caused by:

- Phosphate above 75 mg/L, causes an 11% reduction in reading
- Phosphate above 60 mg/L, causes a 2% reduction in reading
- Sulfide and high concentration of iron
- Eliminate color and turbidity interferences by zeroing the meter with the original water sample

## Silica High Range

### SPECIFICATIONS

Range	0 to 200 mg/L (as SiO <sub>2</sub> )
Resolution	1 mg/L
Accuracy	± 1 mg/L ± 5% of reading at 25 °C
Wavelength	466 nm
Cuvette type	22 mm diameter
Method	Adaptation of the EPA Method 370.1 for Drinking, Surface and Saline Waters, Domestic and Industrial Wastes and Standard Method 4500-SiO <sub>2</sub>
Method ID	#081

### REQUIRED REAGENTS

Code	Description	Quantity
HI96770A-0	Silica High Range Reagent A	1 packet
HI96770B-0	Silica High Range Reagent B	1 packet
HI96770C-0	Silica High Range Reagent C	1 packet

### REAGENT SETS

HI96770-01 Reagents for 100 tests

HI96770-03 Reagents for 300 tests

For other accessories see Accessories section.

### MEASUREMENT PROCEDURE

- Select the **Silica HR** method using the procedure described in the Factory Methods section.

- Fill the cuvette with 10 mL of unreacted sample (up to the mark). Replace the plastic stopper and the cap.



10 mL

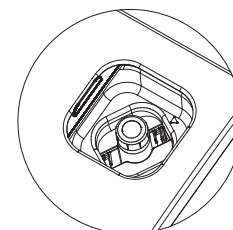

- Insert the cuvette into the holder and close the lid.

- Press **ZERO**. The display will show “-0-” when the meter is zeroed and ready for measurement.

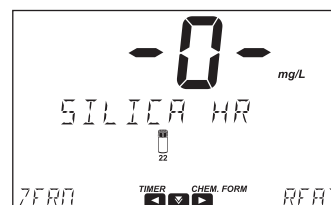
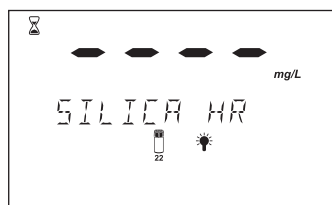
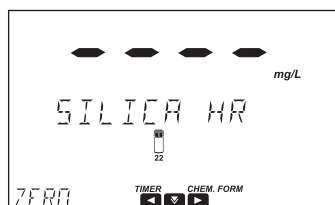

- Remove the cuvette.

- Add one packet of **HI96770A-0** Silica High Range Reagent A. Replace the plastic stopper and the cap. Shake vigorously until completely dissolved.



- Add one packet of **HI96770B-0** Silica High Range Reagent B. Replace the plastic stopper and the cap. Shake vigorously until completely dissolved.

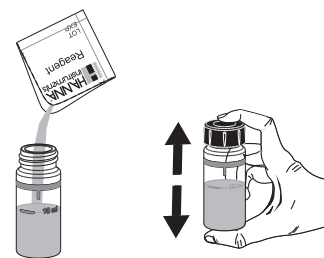

- Press the **◀** key to access the timer menu. Press **START** to start Timer 1, the display will show the countdown or wait 10 minutes.

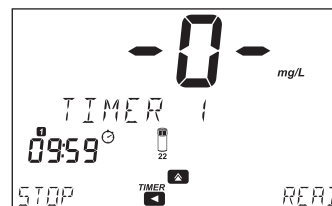
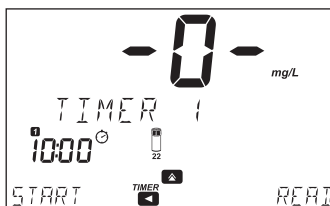
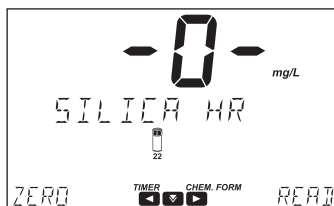

- Add one packet of **HI96770C-0** Silica High Range Reagent C. Replace the plastic stopper and the cap. Shake vigorously until completely dissolved.

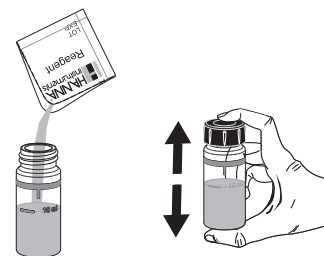

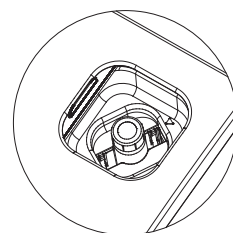

- Insert the cuvette into the holder and close the lid.

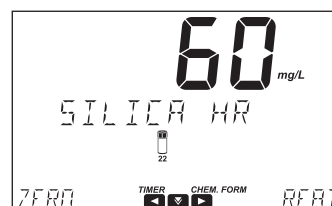
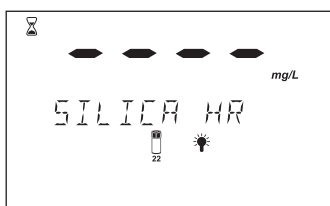
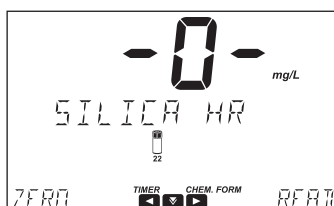
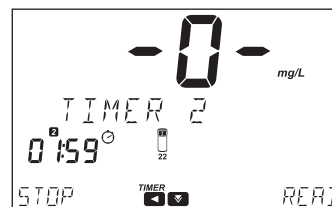
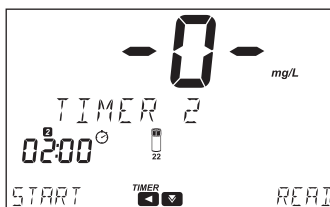
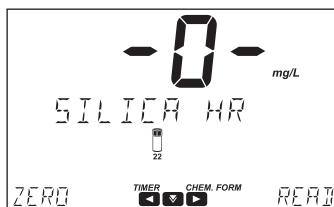

- Press the **◀** key to access the timer menu, press the **▲** key to select Timer 2. Press **START** to start Timer 2, the display will show the countdown prior to measurement or wait 2 minutes.
- Press **READ** to start the reading. The instrument displays the results in **mg/L** of silica ( $\text{SiO}_2$ ).





- Press the  key to view the wavelength, method ID, date and time.
- Press the  key to view the chemical formula.
- Press the  key to convert the results to **mg/L of silicon (Si)**.

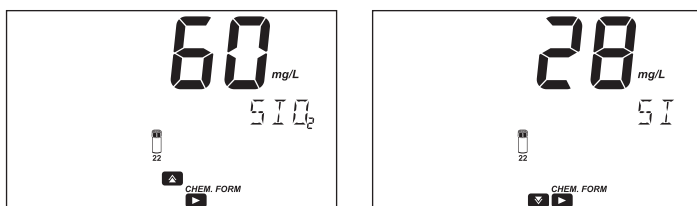

- Press the  key to return to the measurement screen.

### INTERFERENCES

Interference may be caused by:

- Phosphate above 75 mg/L, causes an 11% reduction in reading
- Phosphate above 60 mg/L, causes a 2% reduction in reading
- Sulfide and high concentration of iron
- Eliminate color and turbidity interferences by zeroing the meter with the original water sample

## Silver

### SPECIFICATIONS

Range	0.000 to 1.000 mg/L (as Ag)
Resolution	0.001 mg/L
Accuracy	$\pm 0.020$ mg/L $\pm 5\%$ of reading at 25 °C
Wavelength	570 nm
Cuvette type	22 mm diameter
Method	Adaptation of the PAN Method
Method ID	#082

### REQUIRED REAGENTS

Code	Description	Quantity
HI93737A-0	Silver Reagent A	1 mL
HI93737B-0	Silver Reagent B	1 mL
HI93737C-0	Silver Reagent C	2 mL
HI93737D-0	Silver Reagent D	2 mL
HI93703-51	Dispersing Agent	6 drops

### REAGENT SETS

HI93737-01	Reagents for 50 tests
HI93737-03	Reagents for 150 tests

For other accessories see Accessories section.

**Note:** For best results perform tests between 20 and 24 °C.

### MEASUREMENT PROCEDURE

- Select the **Silver** method using the procedure described in the Factory Methods section.
- Fill two graduated beakers with 25 mL of sample.

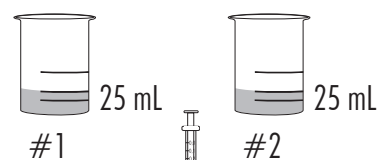

- Add 1 mL of **HI93737A-0** Silver Reagent A to beaker #1 (the blank). Swirl gently to mix.
- Add 1 mL of **HI93737B-0** Silver Reagent B to beaker #2 (the sample). Swirl gently to mix.

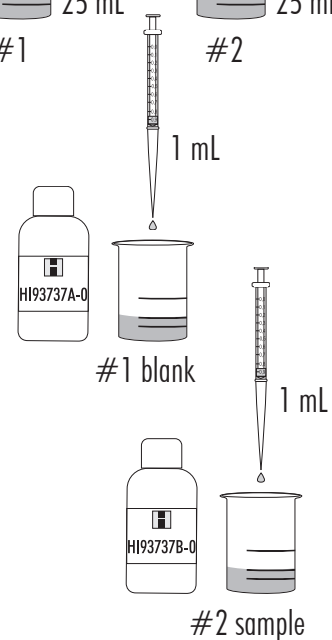

- Press the ◀ key to access the timer menu. Press **START** to start Timer 1, the display will show the countdown prior to adding **HI93737C-0** Silver Reagent C or wait 2 minutes.

• Add 1 mL of **HI93737C-0** Silver Reagent C to each beaker. Swirl to mix.

- Press the ◀ key to access the timer menu, press the ▲ key to select Timer 2. Press **START** to start Timer 2, the display will show the countdown prior to adding **HI93737D-0** Silver Reagent D or wait 2 minutes.

• Add 1 mL of **HI93737D-0** Silver Reagent D to each beaker. Swirl to mix.

- Press the ◀ key to access the timer menu, press the ▲ key to select Timer 3. Press **START** to start Timer 3, the display will show the countdown or wait 2 minutes.

• Fill the first cuvette (#1) with 10 mL of the blank (up to the mark).

- Add 3 drops of [HI93703-51](#) Dispensing Agent. Replace the plastic stopper and the cap. Invert gently for 10 seconds.

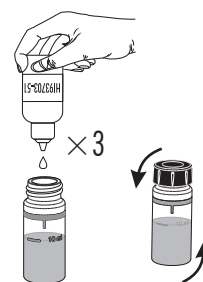

#1

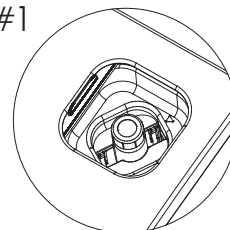

- Insert the cuvette into the holder and close the lid.

- Press **ZERO**. The display will show “-0-” when the meter is zeroed and ready for measurement.

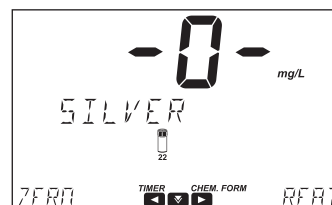
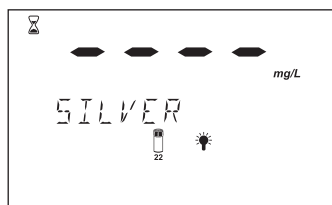
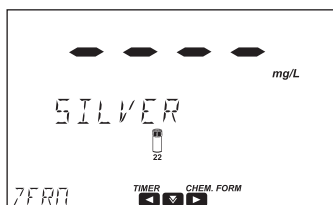

- Fill a second cuvette (#2) with 10 mL of the reacted sample (up to the mark).

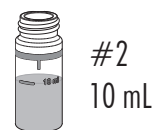

- Add 3 drops of [HI93703-51](#) Dispensing Agent. Replace the plastic stopper and the cap. Invert gently for 10 seconds.

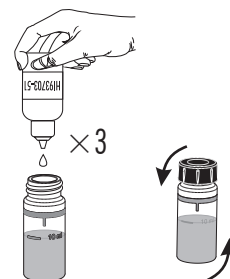

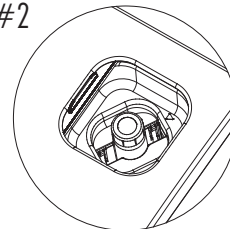

#2

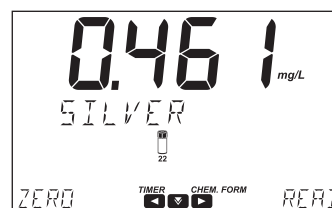
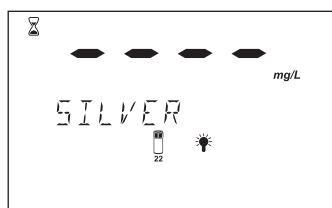
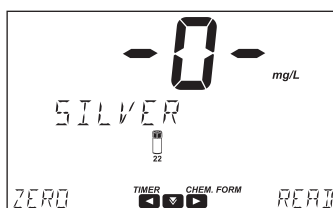

- Insert the second cuvette (#2) into the holder and close the lid.

- Press **READ** to start the reading. The instrument displays the results in mg/L of silver (Ag).



- Press the  key to view the wavelength, method ID, date and time.
- Press the  key to view the chemical formula.

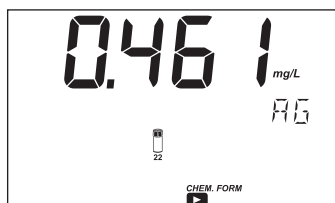

- Press the  key to return to the measurement screen.

### INTERFERENCES

Interference may be caused by:

- Chloride above 8000 mg/L
- Sodium above 5000 mg/L
- Calcium, Magnesium above 1000 mg/L CaCO<sub>3</sub>
- Potassium above 500 mg/L
- Aluminum, Zinc above 30 mg/L
- Chromium(VI) above 40 mg/L
- Manganese above 25 mg/L
- Cadmium, Chromium(III), Fluoride, Lead above 20 mg/L
- Copper above 15 mg/L
- Iron (Ferric) above 10 mg/L
- Cobalt, Iron (Ferrous), Nickel above 1.5 mg/L

## Sulfate

### SPECIFICATIONS

Range	0 to 150 mg/L (as $\text{SO}_4^{2-}$ )
Resolution	1 mg/L
Accuracy	$\pm 5$ mg/L $\pm 3\%$ of reading at 25 °C
Wavelength	466 nm
Cuvette type	22 mm diameter
Method	Sulfate is precipitated with barium chloride crystals
Method ID	#083

### REQUIRED REAGENTS

Code	Description	Quantity
HI93751-0	Sulfate Reagent	1 packet

### REAGENT SETS

HI93751-01 Reagents for 100 tests

HI93751-03 Reagents for 300 tests

For other accessories see Accessories section.

### MEASUREMENT PROCEDURE

- Select the **Sulfate** method using the procedure described in the Factory Methods section.

- Fill a cuvette with 10 mL of unreacted sample (up to the mark). Replace the plastic stopper and the cap.



10 mL

- Insert the cuvette into the holder and close the lid.

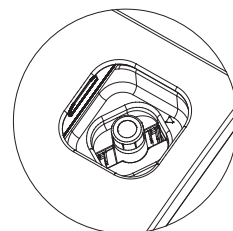

- Press **ZERO**. The display will show “-0-” when the meter is zeroed and ready for measurement.

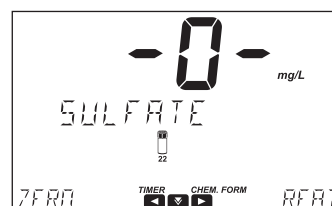
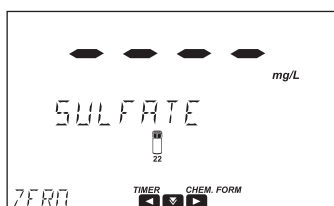

- Add one packet of HI93751-0 Sulfate Reagent.
- Replace the plastic stopper and the cap. Invert gently for 1 minute (about 30 inversions).

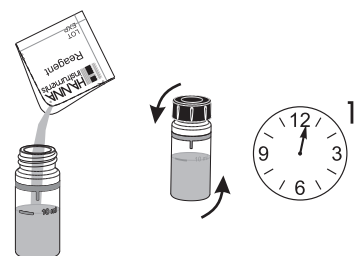

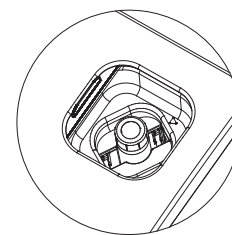

- Insert the cuvette into the holder and close the lid.
- Press the ◀ key to access the timer menu. Press **START** to start Timer 1, the display will show the countdown prior to measurement or wait 5 minutes.
- Press **READ** to start the reading. The instrument displays the results in mg/L of sulfate ( $\text{SO}_4^{2-}$ ).

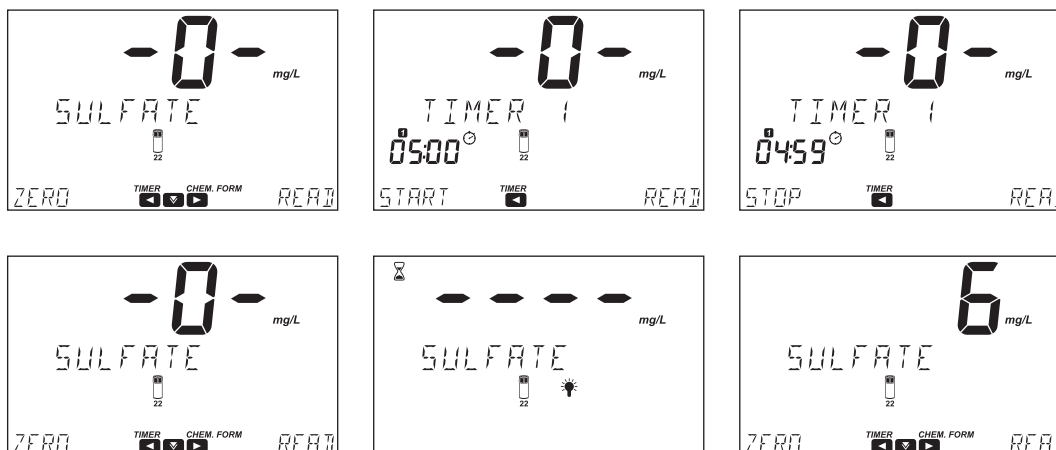

- Press the ▼ key to view the wavelength, method ID, date and time.
- Press the ▶ key to view the chemical formula.

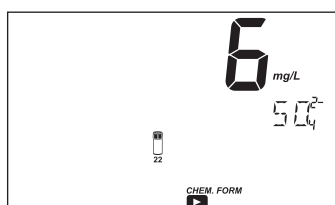

- Press the ▶ key to return to the measurement screen.

## INTERFERENCES

Interferences may be caused by:

- Chloride above 40000 mg/L
- Calcium above 20000 mg/L  $\text{CaCO}_3$
- Magnesium above 10000 mg/L  $\text{MgCO}_3$
- Silica above 500 mg/L  $\text{SiO}_2$
- Color or suspended matter, filter the sample prior to analysis
- Organic matter in large amounts may impede the precipitation of barium sulfate

## Surfactants, Anionic

### SPECIFICATIONS

Range	0.00 to 3.50 mg/L (as SDBS)
Resolution	0.01 mg/L
Accuracy	$\pm 0.04$ mg/L $\pm 3\%$ of reading at 25 °C
Wavelength	610 nm
Cuvette type	22 mm diameter
Method	Adaptation of the EPA Method 425.1 and Standard Methods for the Examination of Water and Wastewater, 20 <sup>th</sup> Edition, 5540C, Anionic Surfactants as MBAS
Method ID	#084

### REQUIRED REAGENTS

Code	Description	Quantity
HI95769A-0	Anionic Surfactants Reagent A	4 drops
HI95769B-0	Anionic Surfactants Reagent B	2 drops
—	Chloroform Reagent	10 mL
DEIONIZED120	Deionized Water	15 mL

### REAGENT SETS

HI95769-01 Reagents for 40 tests  
For other accessories see Accessories section.

### MEASUREMENT PROCEDURE

- Select the [Surfactants Anionic](#) method using the procedure described in the Factory Methods section.
- Fill the graduated mixing cylinder with 25 mL of sample.

**Note:** For improved accuracy the use of class A laboratory pipettes are recommended.

- Add 2 drops of HI95769A-0 Anionic Surfactants Reagent A and 2 drops of HI95769B-0 Anionic Surfactants Reagent B.
- Replace the cap. Invert to mix, the solution will turn blue.
- Add 10 mL of Chloroform. Replace the cap.

**Note:** Chloroform is more dense than water and will sink to the bottom of the graduated mixing cylinder.

- Invert the vial twice and remove the cap to release any pressure that has built up.
- Replace the cap. Shake it vigorously for 30 seconds.

**Note:** Ensure the cap is secure when shaking.

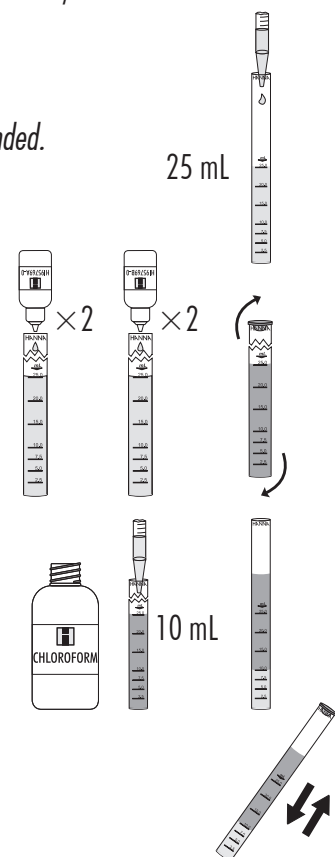



- Press the ◀ key to access the timer menu. Press **START** to start Timer 1, the display will show the countdown or wait 2 minutes. During this period the chloroform layer separates from the aqueous layer, the color of the aqueous layer will fade slightly, while the chloroform layer will turn blue.

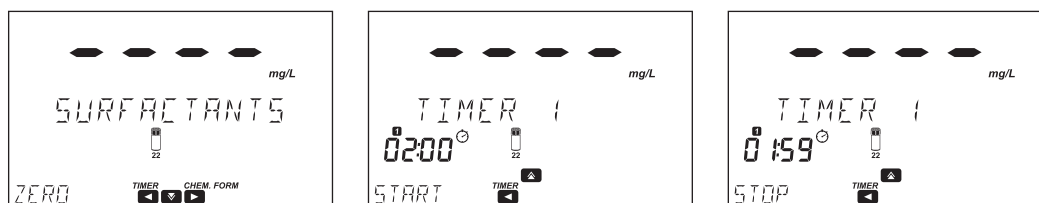

- Remove the cap.
- Remove the upper aqueous layer using the long plastic pipette, do not remove the lower chloroform layer.
- Add 15 mL of deionized water to the graduated mixing cylinder (up to the 25 mL mark).
- Add 2 drops of HI95769A-0 Anionic Surfactants Reagent A. Replace the cap.
- Invert the vial twice and remove the cap to release any pressure that has built up.
- Replace the cap. Shake it vigorously for 30 seconds.

*Note: Ensure the cap is secure when shaking.*

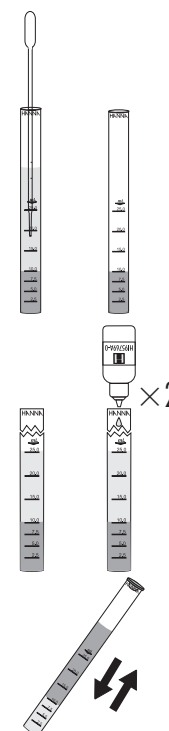

- Press the ◀ key to access the timer menu, press the ▲ key to select Timer 2. Press **START** to start Timer 2, the display will show the countdown or wait 2 minutes. During this period, the chloroform layer separates from the aqueous layer.

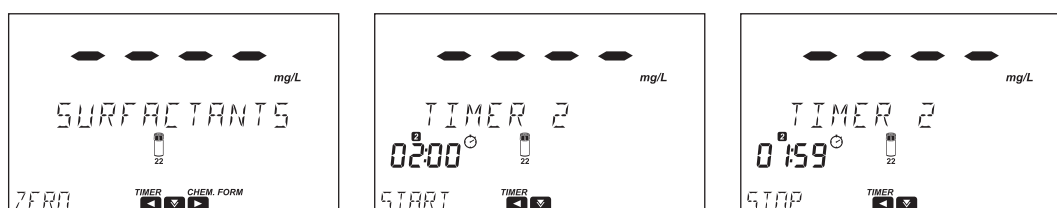

- Remove the cap.
- Insert a clean plastic pipette below the upper aqueous layer to transfer the lower chloroform layer into a cuvette. Do not transfer any of the upper aqueous layer.

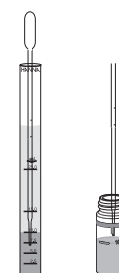

**Notes:** The solution in the cuvette must be clear. If the solution is cloudy, the separation between the chloroform and aqueous layer can be improved by gently warming the cuvette (holding the cuvette in hand). If the chloroform layer contains some aqueous drops hanging on the cuvette wall, gently swirl or invert the cuvette. It is important to transfer at least 7 mL of chloroform layer into the measurement cuvette, thus up to 0.5 cm (1/4") below the 10 mL mark. If the transferred volume is lower than 7 mL, the accuracy of the test may be affected. Please repeat the test waiting for longer than 2 minutes to allow complete separation between the two phases.

- Replace the plastic stopper and the cap. This is the reacted sample (#2).



#2 sample

- Fill another cuvette with 10 mL of Chloroform reagent (up to the mark). Replace the plastic stopper and the cap. This is the blank (#1).

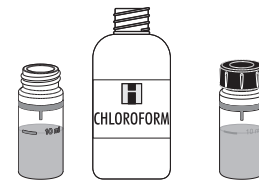

#1 blank

- Insert the blank (#1) into the holder and close the lid.

#1

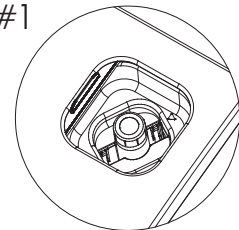

- Press **ZERO**. The display will show "-0-" when the meter is zeroed and ready for measurement.

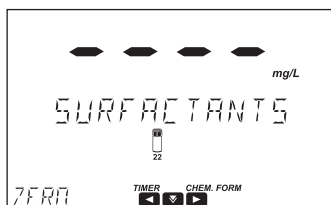

- Remove the cuvette.
- Insert the reacted sample (#2) into the holder and close the lid.

#2

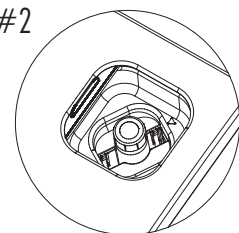

- Press **READ** to start the reading. The instrument displays the result in mg/L as SDBS.



- Press the  key to view the wavelength, method ID, date and time.

- Press the ► key to view the chemical formula.

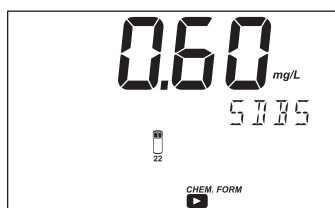

- Press the ► key to return to the measurement screen.

### INTERFERENCES

Interference may be caused by

- Absorption particulate matter, Cationic surfactants, Strong oxidants ( $\text{Cl}_2$ ,  $\text{H}_2\text{O}_2$ ,  $\text{S}_2\text{O}_8^{2-}$  etc.), Sulfide cause negative interference
- Organic sulfates, Sulfonates cause positive interference
- Highly buffered samples or with extreme pH may exceed the buffering capacity of the reagent, pH should be adjusted between 4 and 9 with diluted NaOH or HCl prior to addition of the reagent

## Surfactants, Anionic (13 mm Vial)

### SPECIFICATIONS

Range	0.00 to 3.50 mg/L (as SDBS)
Resolution	0.01 mg/L
Accuracy	$\pm 0.10$ mg/L $\pm 5\%$ of reading at 25 °C
Wavelength	610 nm
Cuvette type	13 mm diameter
Method	Adaptation of the Standard Method for the Examination of Water and Wastewater, 23 <sup>rd</sup> Edition, 5540C, Anionic Surfactants as MBAS
Method ID	#093

### REQUIRED REAGENT

Code	Description	Quantity
HI96782V-0*	Anionic Surfactants Reagent Vial	1 vial
HI96782A-0	Anionic Surfactants Buffer Reagent A	0.6 mL
HI96782B-0	Anionic Surfactants Buffer Reagent B	0.2 mL

\*Reagent vial identification: ANIONIC, white label.

### REAGENT SETS

HI96782-25 Reagents for 25 tests

For other accessories see Accessories section.

**Note:** Store the unused vials in their packaging in a dark place, between 15 and 25 °C.

### PRINCIPLE

Determination of anionic surfactants by measurement of the Methylene Blue Active Substances (MBAS) index. Anionic surfactants react with methylene blue in an alkaline medium, this reaction results in salts that are extracted using chloroform. The blue color of the organic phase is determined photometrically.

### APPLICATION

Water, wastewater, surface water, formulations, degreasing baths, wash solutions, process analysis

### SIGNIFICANCE & USE

Surfactants decrease surface tension at the interface between a liquid and another solid, liquid, or gaseous phase, they are used in industry, agriculture, scientific studies and everyday life (cleaning agents, spot removers, cosmetics, etc.). The most widely used anionic surfactants include sodium dodecyl sulfate (SDS), sodium dodecylbenzene sulfonate (SDBS), sodium dodecane sulfonate (SDSA), sodium dioctyl sulfosuccinate (SDOSSA).

### MEASUREMENT PROCEDURE

- Select the [Surfactants Anionic \(13 mm\)](#) method using the procedure described in the Factory Methods section.
- Insert 13 mm vial adapter using the procedure described in the Cuvette & Vial Adapters section.
- Insert the [HI96782V-0](#) Anionic Surfactants Reagent Vial into the adapter.

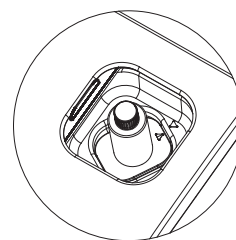

- Press **ZERO**. The display will show “-0-” when the meter is zeroed and ready for measurement.

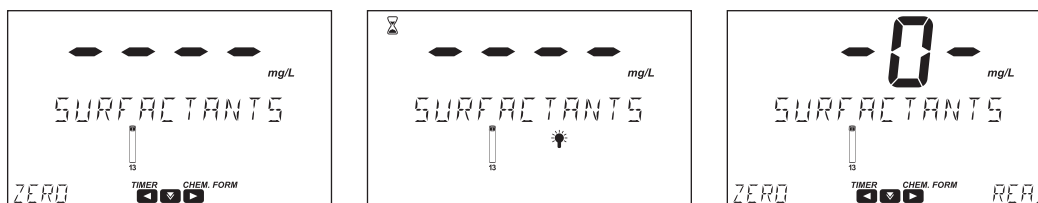

- Remove the vial.
- Add 5 mL of sample to the vial, while keeping the vial at 45-degree angle.

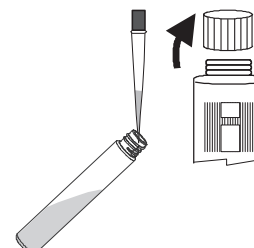

- Add 0.6 mL of **HI96782A-0** Anionic Surfactants Buffer Reagent A and 0.2 mL of **HI96782B-0** Anionic Surfactants Indicator Reagent B.

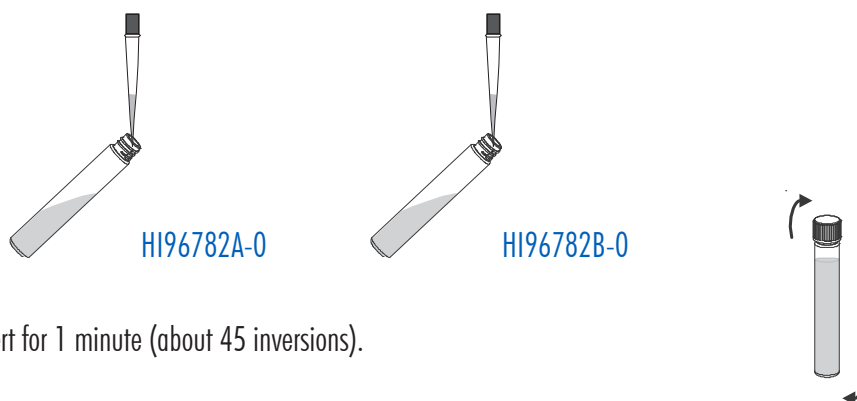

- Replace the cap. Invert for 1 minute (about 45 inversions).

**Note:** This method is technique sensitive. See procedure described in the Cuvette Preparation section for proper mixing technique. If the vial is inverted too slowly the extraction may be incomplete resulting in low readings.

- Press the ◀ key to access the timer menu. Press **START** to start Timer 1. The display will show 1 minute countdown. During this period the organic layer separates from the aqueous layer.

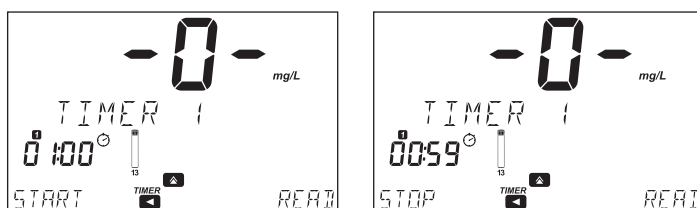

- Invert the vial gently two times.
- Press the ▲ key to select Timer 2. Press **START** to start Timer 2, the display will show the countdown or wait 30 seconds.

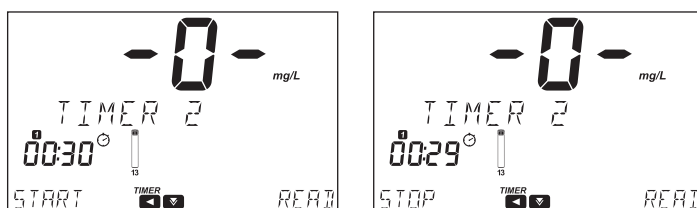

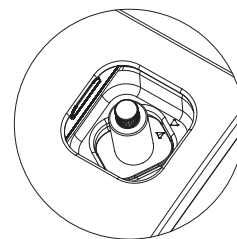

- Insert the vial into the adapter.

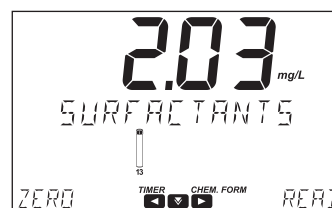
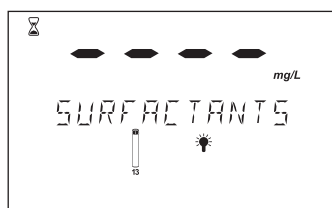
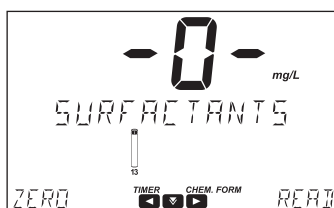

**Note:** Phase separation must be complete before the measurement is taken. If the solution is cloudy, the separation between the organic and aqueous layer can be improved by gently warming the vial (holding the vial in hand). If the organic layer contains some aqueous drops hanging on the vial wall, gently swirl or invert the vial.

- Press **READ** to start the reading. The instrument displays the results in **mg/L** of **SDBS**.



- Press the  key to view the wavelength, method ID, date and time.
- Press the  key to view the chemical formula.

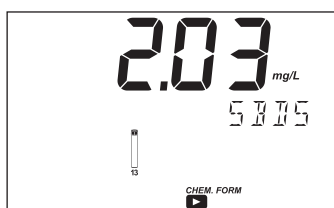

- Press the  key to return to the measurement screen.

## INTERFERENCES

Interference may be caused by:

- Cationic surfactants cause negative interference
- Bicarbonate above 2000 mg/L
- Potassium, Sodium, Sulfate, Chloride above 1000 mg/L
- Phosphate above 300 mg/L
- Magnesium above 250 mg/L
- Calcium, Nitrate above 100 mg/L
- Chromium(VI), Copper above 10 mg/L
- Nickel, Zinc, Iron (Ferric) above 5 mg/L

## Surfactants, Cationic (13 mm Vial)

### SPECIFICATIONS

Range	0.00 to 2.50 mg/L (as CTAB)
Resolution	0.01 mg/L
Accuracy	$\pm 0.15$ ppm $\pm 3\%$ of reading at 25°C
Wavelength	420 nm
Cuvette type	13 mm diameter
Method	Bromophenol Blue Method
Method ID	#095

### REQUIRED REAGENT

Code	Description	Quantity
<a href="#">HI96785V-0</a>	Cationic Surfactants Reagent Vial	1 vial
<a href="#">HI96785-0</a>	Cationic Surfactants Reagent	1 packet

### REAGENT SETS

[HI96785-25](#) Reagents for 25 tests  
For other accessories see Accessories section.

**Note:** Store the unused vials in their packaging in a dark place, between 15 and 25°C.

### PRINCIPLE

Determination of cationic surfactants by measurement of the Methylene Blue Active Substances (MBAS) index. Cationic surfactants react with methylene blue in an acid medium, this reaction results in salts that are extracted using chloroform. The yellow color of the organic phase is determined photometrically.

**Note:** The sample temperature must be between 20 and 22°C, and the pH of the sample between 4 and 9.

### APPLICATION

Water, wastewater, surface water, formulations, degreasing baths, wash solutions, process analysis

### SIGNIFICANCE & USE

Cationic surfactants are positively charged at their hydrophilic ends and as such are active agents in fabric softeners, an important group of detergent products.

Most cationic surfactants find use as disinfectants and sanitizers and include: Hexadecyltrimethylammonium bromide (CTAB), Benzalkonium chloride (BAC), Cetylpyridinium chloride (CPC), Benzethonium chloride (BZT).

### MEASUREMENT PROCEDURE

- Select the [Surfactants Cationic \(13 mm\)](#) method using the procedure described in the Factory Methods section.
- Insert the 13 mm vial adapter using the procedure described in the Cuvette & Vial Adapters section.
- Insert the [HI96785V-0](#) Cationic Surfactants Reagent Vial into the adapter.

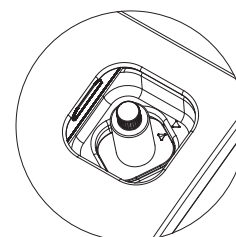

- Press **ZERO**. The display will show “-0-” when the meter is zeroed and ready for measurement.

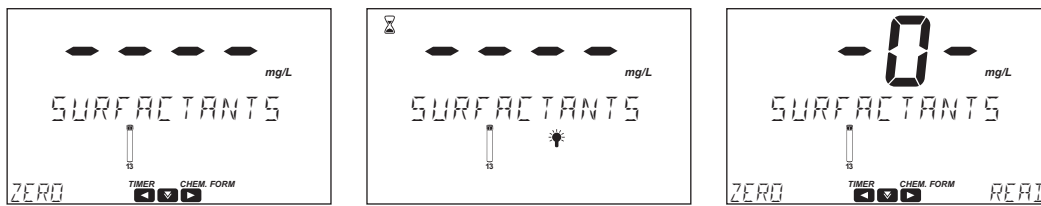

- Remove the vial.
- Remove the cap and add 5 mL of sample to the vial, while keeping the vial at a 45-degree angle.

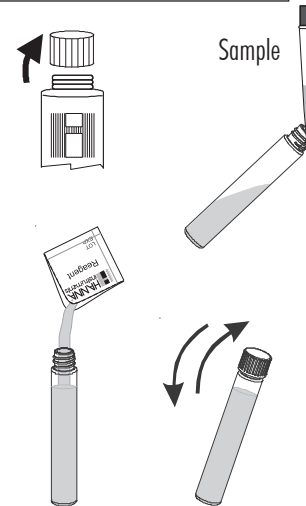

- Add one packet of [HI96785-0](#) Cationic Surfactants Reagent.
- Replace the cap and invert for 2 minutes to mix.

**Note:** This method is technique sensitive. See *Cuvette Preparation* section for proper mixing technique. If the vial is inverted too slowly the extraction may be incomplete resulting in low readings.

- Press the ◀ key to access the timer menu. Press **START** to start Timer 1. The display will show the 30 seconds countdown prior to measurement. During this period the organic layer separates from the aqueous layer.

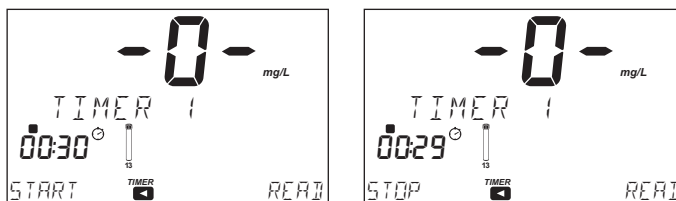

- Invert the vial gently two times.
- Wait for phase separation.
- Wipe the vial thoroughly with [HI731318](#) microfiber cleaning cloth or a lint-free wipe prior to insertion.
- Insert the vial into the adapter.

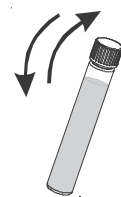

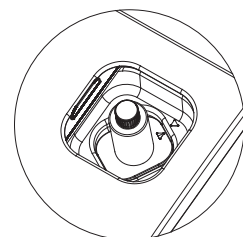

**Note:** Phase separation must be complete before the measurement is taken. If the solution is cloudy, the separation between the organic and aqueous layer can be improved by gently warming the capped vial (holding the vial in your hand). If the organic layer contains some aqueous drops hanging on the vial wall, gently swirl or invert the vial. The phase separation may take several hours if the vial is inverted or shaken too vigorously!





- Press **READ** to start the reading. The instrument displays the result in mg/L of CTAB.



- Press the  key to view the wavelength, method ID, date and time.
- Press the  key to view the chemical formula.

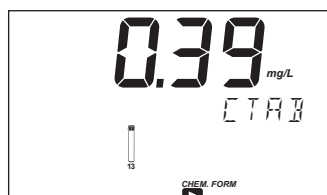

- Press the  key to return to the measurement screen.

### INTERFERENCES

Interference may be caused by:

- Chloride above 3000 mg/L
- Sodium above 2000 mg/L
- Carbonate, Sulfate, Potassium, Nitrate above 1000 mg/L
- Calcium above 500 mg/L
- Phosphate above 300 mg/L
- Ammonium, Magnesium above 250 mg/L
- Iron (Ferric), Nitrite above 100 mg/L
- Zinc, Nickel, Copper, Iron (Ferrous), Hydrogen peroxide ( $H_2O_2$ ), Disulfite ( $S_2O_5^{2-}$ ) above 50 mg/L
- Chlorine, Chromium (VI), Chromium (III) above 10 mg/L
- Anionic surfactants cause negative interference

Interferences checked individually in solution containing 1 mg/L of CTAB (Hexadecyltrimethylammonium bromide).

The cumulative effects have not been determined but can not be excluded.

The determination is not yet interfered with up to the concentrations of foreign substances given above.

## Surfactants, Nonionic (13 mm Vial)

### SPECIFICATIONS

Range	0.00 to 6.00 mg/L (TRITON X-100)
Resolution	0.01 mg/L
Accuracy	$\pm 0.10$ mg/L $\pm 5\%$ of reading at 25 °C
Wavelength	610 nm
Cuvette type	13 mm diameter
Method	TBPE Method
Method ID	#094

### REQUIRED REAGENT

Code	Description	Quantity
HI96780V-0*	Nonionic Surfactants Reagent Vial	1 vial

### REAGENT SETS

HI96780-25 Reagents for 24 tests

\*Reagent vial identification: NON IONIC, blue label

For other accessories see Accessories section.

**Note:** Store the unused vials in their packaging in a dark place, between 15 and 25 °C.

### PRINCIPLE

Nonionic surfactants (ethoxylates with 3 to 20 ether bridges) react with the indicator TBPE to form a green complex, which is then extracted in dichloromethane and photometrically evaluated. This method has a strong temperature and pH dependence. The sample temperature must be between 20 and 22 °C, and the pH between 4 and 9.

### APPLICATION

Water, wastewater, surface water, formulations, degreasing baths, wash solutions, process analysis

### SIGNIFICANCE & USE

Surfactants are one of many different compounds that make up a detergent. Nonionic surfactants do not bear an electrical charge and are often used together with anionic surfactants. Nonionic surfactants account for nearly 50% of surfactant production. Nonionic surfactants are more surface active and better emulsifiers than anionic surfactants at similar concentrations. They are less soluble than anionic surfactants in hot water and produce less foam. They are more efficient in removing oily and organic dirt. Nonionics are used in fabric washing detergents, hard surface cleaners and in many industrial processes such as emulsion polymerization and agrochemical formulations.

### MEASUREMENT PROCEDURE



Before using the reagent kit carefully read all the instructions and the Safety Data Sheets (SDS). Pay particular attention to all warnings, cautions and notes. Failure to do so may result in serious injury to the operator.

**Reagent Blank Correction:** This method requires a reagent blank correction. A single blank vial may be used more than once. The blank vial is stable for several months at room temperature. For improved accuracy, run a blank for each set of measurements and always use the same lot of reagents for blank and samples.

- Select the **Surfactants Nonionic (13 mm)** method using the procedure described in the Factory Methods section.
- Remove the cap from two **HI96780V-0** Surfactants Nonionic Reagent Vials.



- Add 3 mL of deionized water to the first vial (#1) and 3 mL of sample to the second vial (#2), while keeping the vials at a 45-degree angle.

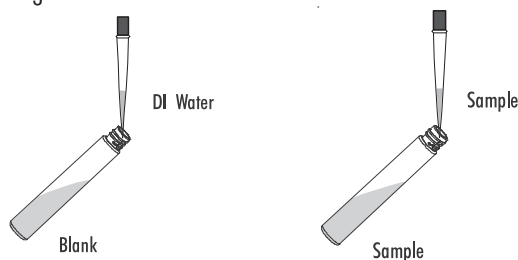

- Replace the cap. Invert for 2 minutes (about 2 inverts per second).

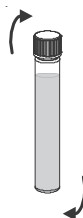

**Note:** The method is technique sensitive. See procedure described in the Cuvette Preparation section for proper mixing technique.

- Press the ◀ key to access the timer menu. Press **START** to start Timer 1, the display will show the countdown or wait 2 minutes. this period the organic layer separates from the aqueous layer.

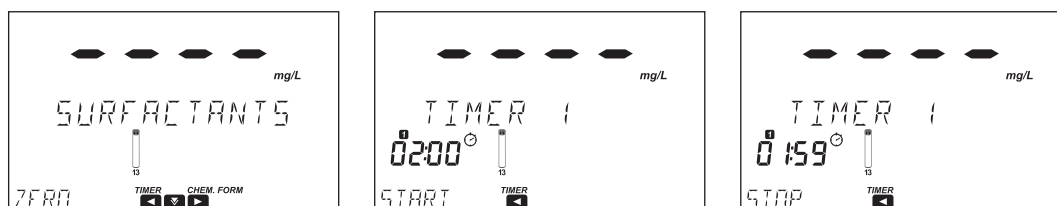

**Note:** Phase separation must be complete before the measurement is taken. If the organic layer contains some aqueous drops hanging on the vial wall, gently swirl or invert the vial.

- Insert the 13 mm vial adapter using the procedure described in the Cuvette & Vial Adapters section.

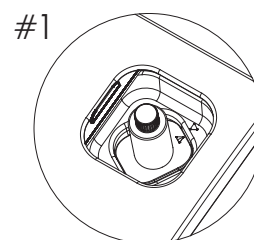

- Insert the blank vial (#1) into the adapter.

- Press **ZERO**. The display will show “-0-” when the meter is zeroed and ready for measurement.

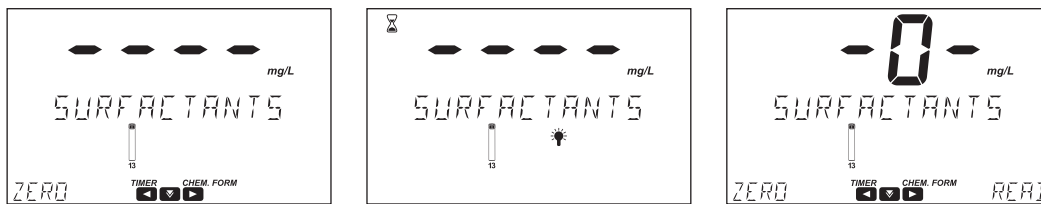

- Remove the blank vial.

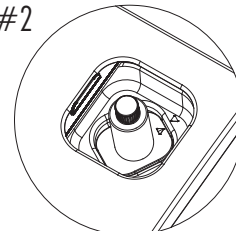

#2



- Insert the sample vial (#2) into the holder.

- Press **READ** to start the reading. The instrument displays the results in mg/L of TRITON X-100.



- Press the  key to view the wavelength, method ID, date and time.
- Press the  key to view the chemical formula.

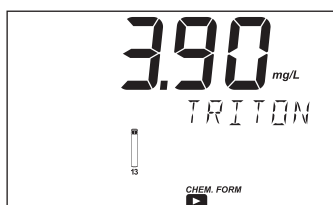

- Press the  key to return to the measurement screen.

## INTERFERENCES

Interference may be caused by:

- Chloride, Nitrate, Sulfate, above 20000 mg/L
- Calcium above 500 mg/L
- Aluminum, Ammonium, Magnesium above 200 mg/L
- Copper, Iron (Ferric), Zinc above 50 mg/L
- Cationic surfactants cause positive interference
- Anionic surfactants cause negative interference

## Zinc

### SPECIFICATIONS

Range	0.00 to 3.00 mg/L (as Zn)
Resolution	0.01 mg/L
Accuracy	$\pm 0.03$ mg/L $\pm 3\%$ of reading at 25 °C
Wavelength	620 nm
Cuvette type	22 mm diameter
Method	Adaptation of the Standard Methods for the Examination of Water and Wastewater, 18 <sup>th</sup> Edition, Zincon Method
Method ID	#085

### REQUIRED REAGENT

Code	Description	Quantity
H193731A-0	Zinc Reagent A	1 packet
H193731B-0	Zinc Reagent B	0.5 mL

### REAGENT SETS

H193731-01	Reagents for 100 tests
H193731-03	Reagents for 300 tests

For other accessories see Accessories section.

### MEASUREMENT PROCEDURE

- Select the **Zinc** method using the procedure described in the Factory Methods section.
- Fill the graduated cylinder up to the 20 mL mark with the sample.
- Add one packet of **H193731A-0** Zinc Reagent A, close the graduated mixing cylinder. Invert several times to mix until completely dissolved.
- Fill a cuvette with 10 mL of the reacted sample (up to the mark). Replace the plastic stopper and the cap.
- Insert the cuvette into the holder and close the lid.

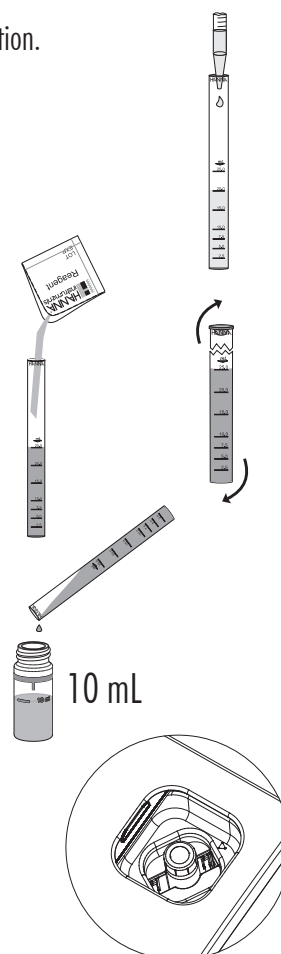

- Press **ZERO**. The display will show “-0-” when the meter is zeroed and ready for measurement.

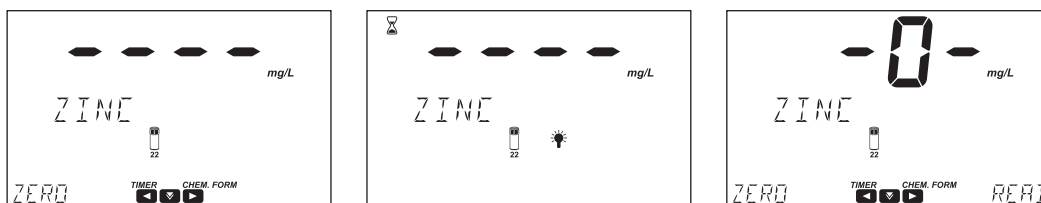

- Add 0.5 mL of **HI93731B-0** Zinc Reagent B to the cuvette. Replace the plastic stopper and the cap.

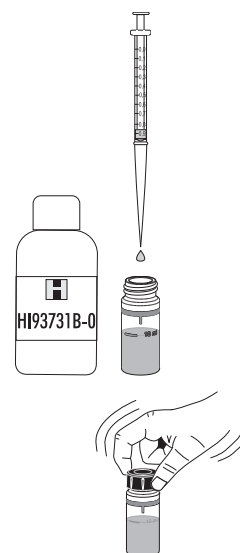

- Swirl gently for 15 seconds.

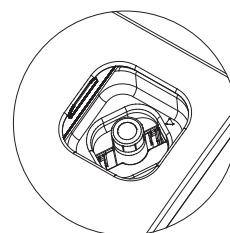

- Insert the sample into the holder and close the lid.

- Press the **◀** key to access the timer menu. Press **START** to start Timer 1, the display will show the countdown prior to measurement or wait 3 minutes and 30 seconds.
- Press **READ** to start the reading. The instrument displays the results in mg/L of zinc (Zn).

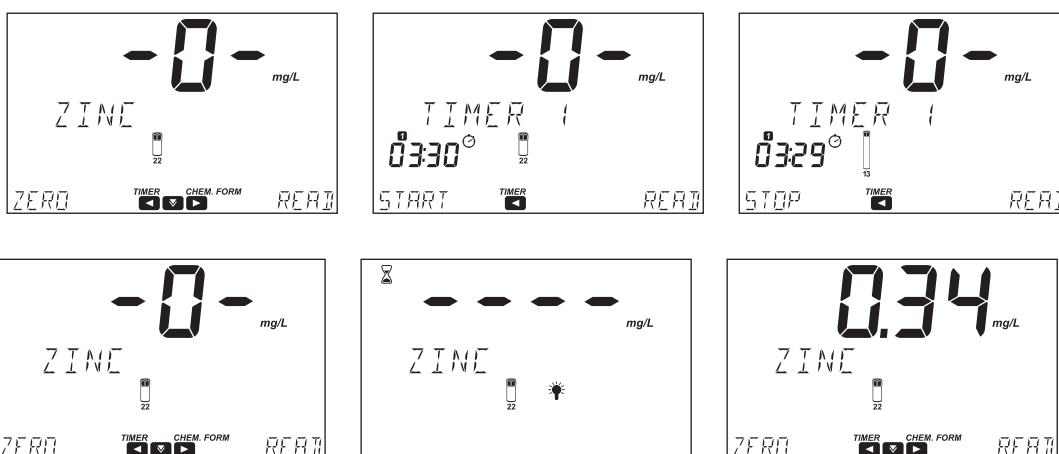

- Press the **▼** key to view the wavelength, method ID, date and time.

- Press the ► key to view the chemical formula.

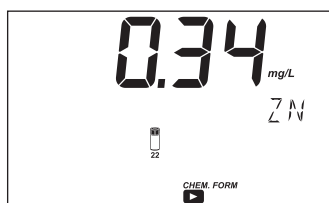

- Press the ► key to return to the measurement screen.

### INTERFERENCES

Interference may be caused by:

- Iron above 7 mg/L
- Aluminum above 6 mg/L
- Copper, Manganese, Nickel above 5 mg/L
- Cadmium above 0.5 mg/L



## 5. ALPHABETICAL LIST OF METHODS

Description	Range	Method
Alkalinity	0 to 500 mg/L	Bromocresol green
Alkalinity, Marine	0 to 300 mg/L	Bromocresol green
Aluminum	0.00 to 1.00 mg/L	Aluminon
Ammonia LR	0.00 to 3.00 mg/L	Nessler
Ammonia LR (13 mm Vial)	0.00 to 3.00 mg/L	Nessler
Ammonia MR	0.00 to 10.00 mg/L	Nessler
Ammonia HR	0.0 to 100.0 mg/L	Nessler
Ammonia HR (13 mm Vial)	0.0 to 100.0 mg/L	Nessler
Bromine	0.00 to 10.00 mg/L	DPD
Calcium	0 to 400 mg/L	Oxalate
Calcium, Marine	200 to 600 mg/L	Zincon
Chloride	0.0 to 20.0 mg/L	Mercury (II) Thiocyanate
Chlorine Dioxide	0.00 to 2.00 mg/L	Chlorophenol Red
Chlorine Dioxide (Rapid)	0.00 to 2.00 mg/L	Adaptation of the 4500 ClO <sub>2</sub> D
Chlorine, Free ULR	0.000 to 0.500 mg/L	DPD
Chlorine, Free LR (powder)	0.00 to 5.00 mg/L	DPD
Chlorine, Free LR (liquid)	0.00 to 5.00 mg/L	DPD
Chlorine, Free HR	0.00 to 10.00 mg/L	DPD
Chlorine, Total ULR	0.000 to 0.500 mg/L	DPD
Chlorine, Total LR (powder)	0.00 to 5.00 mg/L	DPD
Chlorine, Total LR (liquid)	0.00 to 5.00 mg/L	DPD
Chlorine, Total HR	0.00 to 10.00 mg/L	DPD
Chlorine, Total UHR	0 to 500 mg/L	Standard Methods 4500-Cl
Chromium (VI) LR	0 to 300 µg/L	Diphenylcarbohydrazide
Chromium (VI) HR	0 to 1000 µg/L	Diphenylcarbohydrazide
Chromium (VI)/Total (13 mm Vial)	0 to 1000 µg/L	Diphenylcarbohydrazide
COD LR EPA (13 mm Vial)	0 to 150 mg/L	Adaptation of the EPA 410.4
COD LR FREE Hg (13 mm Vial)	0 to 150 mg/L	Dichromate Hg Free
COD LR ISO (13 mm Vial)	0 to 150 mg/L	Dichromate ISO
COD MR EPA (13 mm Vial)	0 to 1500 mg/L	Adaptation of the EPA 410.4
COD MR FREE Hg (13 mm Vial)	0 to 1500 mg/L	Dichromate Hg Free
COD MR ISO (13 mm Vial)	0 to 1000 mg/L	Dichromate ISO





Description	Range	Method
COD HR EPA (13 mm Vial)	0 to 15000 mg/L	Adaptation of the EPA 410.4
COD UHR	0.0 to 60.0 ppt	Adaptation of the EPA 410.4
Color of Water	0 to 500 PCU	Colorimetric Platinum Cobalt
Copper LR	0 to 1500 $\mu$ g/L	Bicinchoninate
Copper HR	0.00 to 5.00 mg/L	Bicinchoninate
Cyanide	0.000 to 0.200 mg/L	Pyridine-Pyrazalone
Cyanuric Acid	0 to 100 mg/L	Turbidimetric
Fluoride LR	0.00 to 2.00 mg/L	SPADNS
Fluoride HR	0.0 to 20.0 mg/L	SPADNS
Hardness, Calcium	0.00 to 2.70 mg/L	Calmagite
Hardness, Magnesium	0.00 to 2.00 mg/L	EDTA
Hardness, Total LR	0 to 250 mg/L	EPA 130.1
Hardness, Total MR	200 to 500 mg/L	EPA 130.1
Hardness, Total HR	400 to 750 mg/L	EPA 130.1
Hydrazine	0 to 400 $\mu$ g/L	p-Dimethylaminobenzaldehyde
Iodine	0.0 to 12.5 mg/L	DPD
Iron LR	0.00 to 1.60 mg/L	TPTZ
Iron HR	0.00 to 5.00 mg/L	Phenanthroline
Iron (II) (Ferrous)	0.00 to 6.00 mg/L	3500-Fe B, Phenanthroline
Iron (13 mm Vial)	0.00 to 6.00 mg/L	3500-Fe B, Phenanthroline
Iron Total (13 mm Vial)	0.00 to 7.00 mg/L	3500-Fe B, Phenanthroline
Magnesium	0 to 150 mg/L	Calmagite
Manganese LR	0 to 300 $\mu$ g/L	PAN
Manganese HR	0.0 to 20.0 mg/L	Periodate
Maple Syrup	0.00 to 100.00%T	Direct measure
Molybdenum	0.0 to 40.0 mg/L	Mercaptoacetic Acid
Nickel LR	0.000 to 1.000 mg/L	PAN
Nickel HR	0.00 to 7.00 ppt	Colorimetric
Nitrate	0.0 to 30.0 mg/L	Cadmium reduction
Nitrate (Chromotropic Acid, 13 mm Vial)	0.0 to 30.0 mg/L	Chromotropic Acid
Nitrite, Marine ULR	0 to 200 $\mu$ g/L	Diazotization
Nitrite LR	0 to 600 $\mu$ g/L	Diazotization
Nitrite LR (13 mm Vial)	0 to 600 $\mu$ g/L	Diazotization

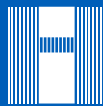

Description	Range	Method
Nitrite MR (13 mm Vial)	0.00 to 6.00 mg/L	Diazotization
Nitrite HR	0 to 150 mg/L	Ferrous Sulfate
Nitrogen, Total LR (13 mm Vial)	0.0 to 25.0 mg/L	Chromotropic Acid
Nitrogen, Total HR (13 mm Vial)	10 to 150 mg/L	Chromotropic Acid
Oxygen, Dissolved	0.0 to 10.0 mg/L	Winkler
Oxygen Scavengers (Carbohydrazide)	0.00-1.50mg/L	Iron Reduction
Oxygen Scavengers (DEHA)	0 to 1000 $\mu$ g/L	Iron Reduction
Oxygen Scavengers (Hydroquinone)	0.00-2.50mg/L	Iron Reduction
Oxygen Scavengers (Isoascorbic Acid)	0.00-4.50mg/L	Iron Reduction
Ozone	0.00 to 2.00 mg/L	DPD
pH	6.5 to 8.5 pH	Phenol Red
Phosphorus, Marine ULR	0 to 200 $\mu$ g/L	Ascorbic Acid
Phosphate LR	0.00 to 2.50 mg/L	Ascorbic Acid
Phosphate HR	0.0 to 30.0 mg/L	Amino Acid
Phosphorus, Acid Hydrolyzable (13 mm Vial)	0.00 to 1.60 mg/L	Ascorbic Acid
Phosphorus, Reactive LR (13 mm Vial)	0.00 to 1.60 mg/L	Ascorbic Acid
Phosphorus, Reactive HR (13 mm Vial)	0.0 to 32.6 mg/L	Vanadomolybdophosphoric Acid
Phosphorus, Total LR (13mm Vial)	0.00 to 1.60 mg/L	Ascorbic Acid
Phosphorus, Total HR (13 mm Vial)	0.0 to 32.6 mg/L	Vanadomolybdophosphoric Acid
Potassium LR	0.0 to 20.0 mg/L	Tetraphenylborate
Potassium MR	10 to 100 mg/L	Tetraphenylborate
Potassium HR	20 to 200 mg/L	Tetraphenylborate
Silica LR	0.00 to 2.00 mg/L	Heteropoly Blue
Silica HR	0 to 200 mg/L	EPA
Silver	0.000 to 1.000 mg/L	PAN
Sulfate	0 to 150 mg/L	Barium Chloride
Surfactants, Anionic	0.00 to 3.50 mg/L	EPA 425.1
Surfactants, Anionic (13 mm Vial)	0.00 to 3.50 mg/L	Adaptation of 5540C
Surfactants, Cationic (13 mm Vial)	0.00 to 2.50 mg/L	Bromophenol Blue
Surfactants, Nonionic (13 mm Vial)	0.00 to 6.00 mg/L	TBPE
Zinc	0.00 to 3.00 mg/L	Zincon



## 6. ACCESSORIES

### 6.1. REAGENT SETS

Ordering Information	Product Description
HI736-25	25 phosphorus marine ULR tests
HI755-26	25 alkalinity marine tests
HI758-26	25 calcium marine tests
HI764-25	25 nitrite marine ULR tests
HI775-26	25 alkalinity fresh water tests
HI93700-01	100 ammonia LR tests
HI93700-03	300 ammonia LR tests
HI93701-01	100 chlorine free LR tests (powder)
HI93701-03	300 chlorine free LR tests (powder)
HI93701-F	300 chlorine free LR tests (liquid)
HI93701-T	300 chlorine total LR tests (liquid)
HI93702-01	100 copper HR tests
HI93702-03	300 copper HR tests
HI93703-52	100 ozone tests
HI93703-57	Glycerol, (4) 30 mL
HI93704-01	100 hydrazine tests
HI93704-03	300 hydrazine tests
HI93705-01	100 silica LR tests
HI93705-03	300 silica LR tests
HI93707-01	100 nitrite LR tests
HI93707-03	300 nitrite LR tests
HI93708-01	100 nitrite HR tests
HI93708-03	300 nitrite HR tests
HI93709-01	100 manganese HR tests
HI93709-03	300 manganese HR tests
HI93710-01	100 pH tests
HI93710-03	300 pH tests
HI93711-01	100 chlorine total LR tests (powder)
HI93711-03	300 chlorine total LR tests (powder)
HI93712-01	100 aluminum tests
HI93712-03	300 aluminum tests
HI93713-01	100 phosphate LR tests

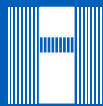

Ordering Information	Product Description
HI93713-03	300 phosphate LR tests
HI93714-01	100 cyanide tests
HI93714-03	300 cyanide tests
HI93715-01	100 ammonia MR tests
HI93715-03	300 ammonia MR tests
HI93716-01	100 bromine tests
HI93716-03	300 bromine tests
HI93717-01	100 phosphate HR tests
HI93717-03	300 phosphate HR tests
HI93718-01	100 iodine tests
HI93718-03	300 iodine tests
HI93719-01	100 hardness magnesium tests
HI93719-03	300 hardness magnesium tests
HI93720-01	100 hardness calcium tests
HI93720-03	300 hardness calcium tests
HI93721-01	100 iron HR tests
HI93721-03	300 iron HR tests
HI93722-01	100 cyanuric acid tests
HI93722-03	300 cyanuric acid tests
HI93723-01	100 chromium (VI) HR tests
HI93723-03	300 chromium (VI) HR tests
HI93726-01	100 nickel HR tests
HI93726-03	300 nickel HR tests
HI93728-01	100 nitrate tests
HI93728-03	300 nitrate tests
HI93729-01	100 fluoride LR tests
HI93729-03	300 fluoride LR tests
HI93730-01	100 molybdenum tests
HI93730-03	300 molybdenum tests
HI93731-01	100 zinc tests
HI93731-03	300 zinc tests
HI93732-01	100 dissolved oxygen tests
HI93732-03	300 dissolved oxygen tests
HI93733-01	100 ammonia HR tests



Ordering Information	Product Description
HI93733-03	300 ammonia HR tests
HI93734-01	100 chlorine free and total HR tests
HI93734-03	300 chlorine free and total HR tests
HI93735-01	100 hardness total MR tests (200 to 500 mg/L)
HI93735-02	100 hardness total HR tests (400 to 750 mg/L)
HI93735-0	300 hardness total tests (LR - 100 tests, MR - 100 tests, HR - 100 tests)
HI93735-00	100 hardness total LR tests (0 to 250 mg/L)
HI93737-01	50 silver tests
HI93737-03	150 silver tests
HI93738-01	100 chlorine dioxide tests
HI93738-03	300 chlorine dioxide tests
HI93739-01	100 fluoride HR tests
HI93739-03	300 fluoride HR tests
HI93740-01	50 nickel LR tests
HI93740-03	150 nickel LR tests
HI93746-01	50 iron LR tests
HI93746-03	150 iron LR tests
HI93748-01	50 manganese LR tests
HI93748-03	150 manganese LR tests
HI93749-01	100 chromium (VI) LR tests
HI93749-03	300 chromium (VI) LR tests
HI93750-01	100 potassium LR, MR, HR tests
HI93750-03	300 potassium LR, MR, HR tests
HI93751-01	100 sulfate tests
HI93751-03	300 sulfate tests
HI937520-01	50 magnesium tests
HI937520-03	150 magnesium tests
HI937521-01	50 calcium fresh water tests
HI937521-03	150 calcium fresh water tests
HI93753-01	100 chloride tests
HI93753-03	300 chloride tests
HI93754A-25	24 chemical oxygen demand LR EPA tests (Vial)
HI93754B-25	24 chemical oxygen demand MR EPA tests (Vial)
HI93754C-25	24 chemical oxygen demand HR EPA tests (Vial)

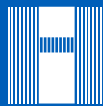

Ordering Information	Product Description
HI93754D-25	24 chemical oxygen demand LR Hg free tests (Vial)
HI93754E-25	24 chemical oxygen demand MR Hg free tests (Vial)
HI93754F-25	24 chemical oxygen demand LR ISO tests (Vial)
HI93754G-25	24 chemical oxygen demand MR ISO tests (Vial)
HI93754J-25	24 chemical oxygen demand UHR tests (Vial)
HI93757-01	100 ozone tests
HI93757-03	300 ozone tests
HI93758A-50	50 phosphorus reactive LR tests (Vial)
HI93758B-50	50 phosphorus acid hydolyzable tests (Vial)
HI93758C-50	50 phosphorus total LR tests (Vial)
HI93763A-50	49 phosphorus reactive HR tests (Vial)
HI93763B-50	49 phosphorus total HR tests (Vial)
HI93764A-25	25 ammonia LR tests (Vial)
HI93764B-25	25 ammonia HR tests (Vial)
HI93766-50	50 nitrate tests (Vial)
HI93767A-50	49 nitrogen total LR tests (Vial)
HI93767B-50	49 nitrogen total HR tests (Vial)
HI95747-01	100 copper LR tests
HI95747-03	300 copper LR tests
HI95761-01	100 chlorine total ULR tests
HI95761-03	300 chlorine total ULR tests
HI95762-01	100 chlorine free ULR tests
HI95762-03	300 chlorine free ULR tests
HI95769-01	40 surfactants anionic tests
HI96770-01	100 silica HR tests
HI96770-03	300 silica HR tests
HI95771-01	100 chlorine total UHR tests
HI95771-03	300 chlorine total UHR tests
HI96773-01	50 oxygen scavengers tests
HI96773-03	150 oxygen scavengers tests
HI96779-01	100 chlorine dioxide (rapid) tests
HI96779-03	300 chlorine dioxide (rapid) tests
HI96781-25	25 chromium VI/total tests (Vial)
HI96776-01	100 iron(II) tests
HI96776-03	300 iron(II) tests



<b>Ordering Information</b>	<b>Product Description</b>
HI96778-25	25 total iron tests (Vial)
HI96780-25	24 surfactants, nonionic tests (Vial)
HI96782-25	25 surfactants, anionic tests (Vial)
HI96783-25	25 nitrite LR tests (Vial)
HI96784-25	25 nitrite MR tests (Vial)
HI96785-25	25 surfactants, cationic tests (Vial)
HI96786-25	25 iron tests (Vial)



## 6.2. OTHER ACCESSORIES

Ordering Information	Product Description
HI731311	Vial 13 mm diam (5 pcs.)
HI731318	Cloth for wiping cuvettes (4 pcs.)
HI731321	Glass cuvettes 16 mm diam (4 pcs.)
HI731225	Cap for 16 mm cuvette (4 pcs.)
HI731331	Glass cuvettes 22 mm diam (4 pcs.)
HI731335N	Cap for cuvette 22 mm cuvette (4 pcs.)
HI731339P	100 $\mu$ L automatic pipette
HI731349P	Pipette tip for 100 $\mu$ L graduated pipette (10 pcs.)
HI731340	200 $\mu$ L automatic pipette
HI731350	Pipette tip for 200 $\mu$ L graduated pipette (25 pcs.)
HI731341	1000 $\mu$ L automatic pipette
HI731351	Pipette tip for 1000 $\mu$ L graduated pipette (25 pcs.)
HI731342	2000 $\mu$ L automatic pipette
HI731352	Pipette tip for 2000 $\mu$ L graduated pipette (25 pcs.)
HI740034P	Cap for 100 mL beaker (10 pcs.)
HI740036P	100 mL plastic beaker (10 pcs.)
HI740038	60 mL glass bottle and stopper
HI740142P	1 mL graduated syringe (10 pcs)
HI740143	1 mL graduated syringe (6 pcs.)
HI740144P	Pipette tip for 1 mL graduated syringe (10 pcs.)
HI740157P	Plastic refilling pipette (20 pcs.)
HI740216	Cooling rack
HI740217	Safety shield for reactor
HI740220	25 mL glass mixing vial (2 pcs.)
HI740225	60 mL graduated syringe
HI740226	5 mL graduated syringe
HI740227	Filter assembly
HI740228	Filter discs (25 pcs.)
HI740229	100 mL graduated cylinder
HI7408011	16 mm cuvette adapter
HI7408012	10 mm cuvette adapter
HI7408013	13 mm cuvette adapter
HI7408014	Replacement tungsten halogen lamp for HI801 iris <sup>®</sup> spectrophotometer





Ordering Information	Product Description
HI7408015	Replacement battery for HI801 iris <sup>®</sup> spectrophotometer
HI740230	Demineralized water (230 mL)
HI83300-100	Sample preparation kit consisting of activated carbon for 50 tests, demineralizer bottle for 10 L of water, 100 mL graduated beaker with cap, 170 mL graduated beaker with cap, 3 mL pipette, 60 mL syringe, 5 mL syringe, graduated cylinder, spoon, funnel, filter paper (25 pcs.).
HI839800-01	Reactor, 230 VAC to 15 VDC power adapter, European plug
HI839800-02	Reactor, 115 VAC to 15 VDC power adapter, USA plug
HI93703-50	Cuvette cleaning solution (230 mL)
HI93703-55	Activated carbon (50 pcs.)
HI75110/15	115 VAC to 15 VDC power adapter, USA plug
HI75220/15	230 VAC to 15 VDC power adapter, European plug



## CERTIFICATION

All Hanna<sup>®</sup> instruments conform to the **CE European Directives**.



**Disposal of Electrical & Electronic Equipment.** The product should not be treated as household waste. Instead, hand it over to the appropriate collection point for the recycling of electrical and electronic equipment, which will conserve natural resources.

**Disposal of waste batteries.** This product contains batteries, do not dispose of them with other household waste. Hand them over to the appropriate collection point for recycling.

Ensuring proper product and battery disposal prevents potential negative consequences for the environment and human health. For more information, contact your city, your local household waste disposal service, or the place of purchase.



## RECOMMENDATIONS FOR USERS

Before using this product, make sure it is entirely suitable for your specific application and for the environment in which it is used. Any variation introduced by the user to the supplied equipment may degrade the photometer's performance. For your and the meter's safety do not use or store the meter in hazardous environments.

## WARRANTY

The **HI801 iris<sup>®</sup>** spectrophotometer is warranted for two years against defects in workmanship and materials when used for its intended purpose and maintained according to instructions. This warranty is limited to repair or replacement free of charge. Damage due to accidents, misuse, tampering, or lack of prescribed maintenance is not covered.

If service is required, contact your local Hanna Instruments<sup>®</sup> office. If under warranty, report the model number, date of purchase, serial number (engraved on the bottom of the meter), and the nature of the problem. If the repair is not covered by the warranty, you will be notified of the charges incurred. If the instrument is to be returned to Hanna Instruments, first obtain a Returned Goods Authorization (RGA) number from the Technical Service department and then send it with shipping costs prepaid. When shipping any instrument, make sure it is properly packed for complete protection.

MAN801 03/22

Hanna Instruments reserves the right to modify the design, construction or appearance of its products without advance notice.



## World Headquarters

Hanna Instruments Inc.  
Highland Industrial Park  
584 Park East Drive  
Woonsocket, RI 02895 USA  
[www.hannainst.com](http://www.hannainst.com)