

HI83399

Multiparameter Photometer
with COD
for Water & Wastewater



INSTRUCTION MANUAL

Dear
Customer,

Thank you for choosing a Hanna Instruments® product.

Please read this instruction manual carefully before using this instrument.

This manual will provide you with the necessary information for correct use of this instrument, as well as a precise idea of its versatility.

If you need additional technical information, do not hesitate to e-mail us at tech@hannainst.com or view our contact list at www.hannainst.com.

All rights are reserved. Reproduction in whole or in part is prohibited without the written consent of the copyright owner, Hanna Instruments Inc., Woonsocket, Rhode Island, 02895, USA.

TABLE OF CONTENTS

1. Preliminary Examination	7
2. Safety Measures	7
3. Specifications	8
4. Abbreviations	9
5. Description	10
5.1. General Description & Intended Use	10
5.2. Precision & Accuracy	10
5.3. Functional Description	11
5.4. Principle of Operation	12
5.5. Optical System	13
6. General Operations	14
6.1. Power Connection & Battery Management	14
6.2. Mode Selection	14
6.3. General Setup	15
6.4. Contextual Help	18
7. Logging Data & Data Management	19
7.1. Logging Data	19
7.2. Adding Sample & User Names to Log Data	19
7.3. Data Management	20
8. Photometer Mode	21
8.1. Method Selection	21
8.2. Collecting & Measuring Samples and Reagents	21
8.3. Cuvette Preparation	22
8.4. Using the 16 mm Vial Adapter	24
8.5. Timers & Measurement Functions	25
8.6. Chemical Formula & Unit Conversion	26
8.7. Meter Validation & CAL Check™	26
8.8. Absorbance Measurements	27
9. Probe Mode	28
9.1. pH Measurement	28
9.2. pH Calibration	29
9.3. pH Messages & Warnings	30
9.4. pH GLP	31
9.5. pH Electrode Conditioning & Maintenance	32

10. Method Procedures	34
10.1. Alkalinity	34
10.2. Alkalinity, Marine	36
10.3. Aluminum	38
10.4. Ammonia Low Range	42
10.5. Ammonia Low Range (16 mm Vial).....	45
10.6. Ammonia Medium Range	48
10.7. Ammonia High Range	51
10.8. Ammonia High Range (16 mm Vial)	54
10.9. Bromine.....	57
10.10. Calcium.....	59
10.11. Calcium, Marine.....	62
10.12. Chloride	64
10.13. Chlorine Dioxide.....	67
10.14. Chlorine Dioxide, Rapid Method.....	71
10.15. Chlorine, Free	74
10.16. Chlorine, Free Ultra Low Range	77
10.17. Chlorine, Total	79
10.18. Chlorine, Total Ultra Low Range.....	83
10.19. Chlorine, Total Ultra High Range	85
10.20. Chromium(VI) Low Range.....	87
10.21. Chromium(VI) High Range.....	89
10.22. Chromium(VI)/Total (16 mm Vial).....	91
10.23. Chemical Oxygen Demand Low Range (16 mm Vial).....	96
10.24. Chemical Oxygen Demand Medium Range (16 mm Vial).....	99
10.25. Chemical Oxygen Demand High Range (16 mm Vial).....	102
10.26. Chemical Oxygen Demand, Ultra High Range (16 mm Vial).....	105
10.27. Color of Water	108
10.28. Copper Low Range	110
10.29. Copper High Range	112
10.30. Cyanuric Acid.....	114
10.31. Fluoride Low Range.....	116
10.32. Fluoride High Range	118
10.33. Hardness, Calcium	121
10.34. Hardness, Magnesium.....	124
10.35. Hardness, Total Low Range	127

10.36. Hardness, Total Medium Range.....	130
10.37. Hardness, Total High Range.....	133
10.38. Hydrazine	136
10.39. Iodine.....	138
10.40. Iron Low Range	140
10.41. Iron High Range	143
10.42. Iron(II)	145
10.43. Iron(II)/(III)	148
10.44. Iron (16 mm Vial)	152
10.45. Iron, Total (16 mm Vial).....	155
10.46. Magnesium	159
10.47. Manganese Low Range.....	161
10.48. Manganese High Range	164
10.49. Molybdenum	167
10.50. Nickel Low Range	170
10.51. Nickel High Range	173
10.52. Nitrate	175
10.53. Nitrate (16 mm Vial)	178
10.54. Nitrite, Marine Ultra Low Range	181
10.55. Nitrite Low Range	183
10.56. Nitrite Low Range (16 mm Vial).....	185
10.57. Nitrite Medium Range (16 mm Vial)	188
10.58. Nitrite High Range	191
10.59. Nitrogen, Total Low Range (16 mm Vial)	193
10.60. Nitrogen, Total High Range (16 mm Vial).....	198
10.61. Oxygen, Dissolved	203
10.62. Oxygen Scavengers (Carbohydrazide).....	206
10.63. Oxygen Scavengers (Diethylhydroxylamine) (DEHA)	209
10.64. Oxygen Scavengers (Hydroquinone).....	212
10.65. Oxygen Scavengers (Iso-Ascorbic Acid).....	215
10.66. Ozone.....	218
10.67. pH.....	222
10.68. Phosphate, Marine Ultra Low Range.....	224
10.69. Phosphate Low Range	226
10.70. Phosphate High Range.....	228
10.71. Phosphorus, Reactive Low Range (16 mm Vial).....	231

10.72. Phosphorus, Reactive High Range (16 mm Vial).....	234
10.73. Phosphorus, Acid Hydrolyzable (16 mm Vial).....	237
10.74. Phosphorus, Total Low Range (16 mm Vial).....	241
10.75. Phosphorus, Total High Range (16 mm Vial).....	245
10.76. Potassium.....	249
10.77. Silica Low Range.....	252
10.78. Silica High Range.....	255
10.79. Silver.....	258
10.80. Sulfate.....	262
10.81. Surfactants, Anionic.....	264
10.82. Surfactants, Anionic (16 mm Vial).....	268
10.83. Surfactants, Cationic (16 mm Vial).....	272
10.84. Surfactants, Nonionic (16 mm Vial).....	276
10.85. Zinc.....	280
11. Warnings & Errors.....	282
12. Standard Methods.....	285
13. Accessories.....	288
13.1. Reagent Sets.....	288
13.2. pH Electrodes.....	292
13.3. pH Solutions.....	293
13.4. Other Accessories.....	295
Certification.....	297
Recommendations for Users.....	297
Warranty.....	298

1. PRELIMINARY EXAMINATION

Remove the instrument and accessories from the packaging and examine it carefully. For further assistance, please contact your local Hanna Instruments® office or email us at tech@hannainst.com. Each HI83399 is delivered in a rugged carrying case and is supplied with:

- Sample cuvette (4 pcs.)
- Sample cuvette cap (4 pcs.)
- Cloth for wiping cuvettes
- Scissors
- USB cable
- 5 Vdc power adapter
- 16 mm vial adapter
- 16 mm diameter vial with cap (6 pcs.)
- 60 mL glass bottle
- Instrument quality certificate
- Instruction manual

***Note:** Save all packing material until you are sure that the instrument works correctly. Any damaged or defective item must be returned in its original packing material with the supplied accessories.*

2. SAFETY MEASURES



- The chemicals contained in the reagent kits may be hazardous if improperly handled.
- Read the Safety Data Sheets (SDS) before performing tests.
- Safety equipment: Wear suitable eye protection and clothing when required and follow instructions carefully.
- Reagent spills: If a reagent spill occurs, wipe up immediately and rinse with plenty of water. If reagent contacts skin, rinse the affected area thoroughly with water. Avoid breathing released vapors.
- Waste disposal: For proper disposal of reagent kits and reacted samples, contact a licensed waste disposal provider.

3. SPECIFICATIONS

Photometer	Measurement Channels	5 x optical channels 1 x digital electrode channel (pH measurement)
	Range	0.000 to 4.000 Abs
	Resolution	0.001 Abs
	Accuracy	± 0.003 Abs @ 1.000 Abs
	Light source	Light Emitting Diode
	Bandpass filter bandwidth	8 nm
	Bandpass filter wavelength accuracy	± 1.0 nm
	Light detector	Silicon photocell
	Cuvette types	Round, 24.6 mm & 16 mm diameter
	Number of methods	90
Probe	Range	-2.00 to 16.00 pH (± 1000.0 mV)*
	Resolution	0.01 pH (0.1 mV)
	Accuracy	± 0.01 pH (± 0.2 mV) @ 25 °C (77 °F)
	Temperature compensation	ATC, -5.0 to 100.0 °C (23.0 to 212.0 °F) *
	Calibration	two-point, from five available buffers (4.01, 6.86, 7.01, 9.18, 10.01 pH)
Temperature	Electrode	Intelligent pH / temperature electrode
	Range	-20.0 to 120.0 °C (-4.0 to 248.0 °F)
	Resolution	0.1 °C (0.1 °F)
	Accuracy	± 0.5 °C @ 25 °C (± 0.9 ° @ 77 °F)
Additional Specifications	Logging	1000 readings (mixed photometer and electrode)
	Display	128 x 64 pixel B/W LCD with backlight
	USB-A (Host) functions	Mass-storage host
	USB-B (Device) functions	Power input, mass-storage device
	Battery life	> 500 photometer measurements or 50 hours of continuous pH measurement
	Power supply	5 Vdc USB 2.0 power adapter / type micro-B connector 3.7 Vdc Li-polymer rechargeable battery, non-serviceable
	Environment	0 to 50 °C (32 to 122 °F) 0 to 95 % RH, non-serviceable
	Dimensions	206 x 177 x 97 mm (8.1 x 7.0 x 3.8")
	Weight	1.0 kg (2.2 lbs.)

* Limits will be reduced to actual probe / sensor limits.

4. ABBREVIATIONS

Abs	Absorbance
COD	Chemical Oxygen Demand
DPD	N,N-diethyl-p-phenylenediamine
EPA	US Environmental Protection Agency
GLP	Good Laboratory Practice
HDPE	High-Density Polyethylene
NIST	National Institute of Standards and Technology
TBPE	Tetrabromophenolphthalein Ethyl Ester
TRRS	Tip/Ring/Ring/Sleeve

g/L	grams per liter (parts per thousand, ppt)
μ g/L	micrograms per liter (parts per billion, ppb)
mg/L	milligrams per liter (parts per million, ppm)

HR	High Range
LR	Low Range
MR	Medium Range
UHR	Ultra High Range
ULR	Ultra Low Range

5. DESCRIPTION

5.1. General Description & Intended Use

HI83399 multiparameter photometer is a compact and versatile meter with two measurement modes, Photometer and Probe. Photometer mode includes a CAL Check™ feature and 90 different methods that cover a wide variety of applications, making it ideal for both benchtop and portable operations. With the CAL Check feature users are able to validate the performance of the instrument and apply a user calibration (if necessary). Hanna Instruments® CAL Check cuvettes are made with NIST traceable standards. Probe mode uses a digital pH probe with a one or two-point calibration.

- Digital electrode input for pH measurements
- Certified CAL Check cuvettes to confirm meter functionality
- Dual purpose micro-USB flash drive
- Lithium polymer rechargeable battery
- Auto-off
- Absorbance mode
- User and sample name entry
- GLP features

5.2. Precision & Accuracy

Precision is how closely repeated measurements are to one another. Precision is usually expressed as standard deviation. Accuracy is defined as the closeness of a test result to the true value. Although good precision suggests good accuracy, precise results can be inaccurate. The figure explains these definitions. For each method, the accuracy is expressed in the related measurement section.

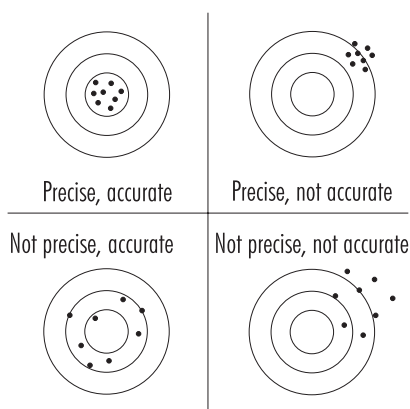



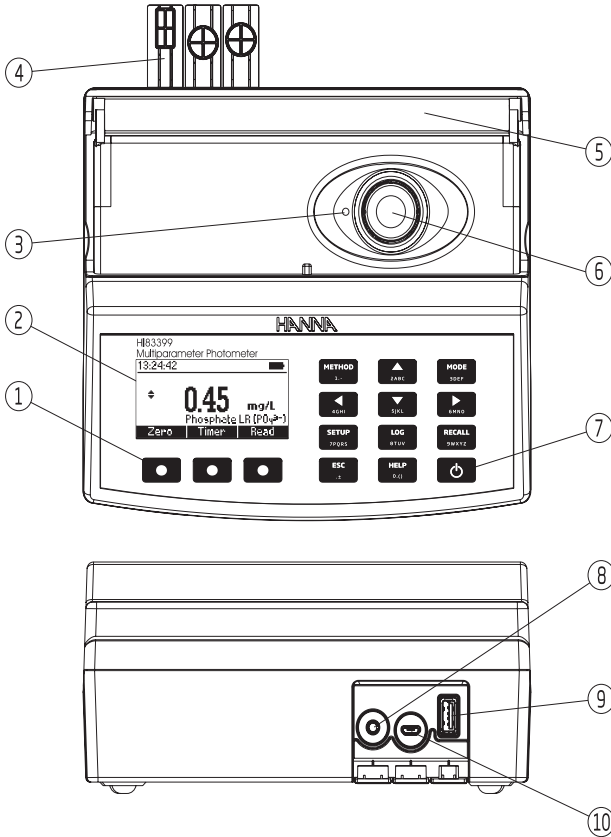









5.3. Functional Description



1. Splash-proof keypad
2. Liquid Crystal Display (LCD)
3. Indexing mark
4. Protective port covers
5. Light-blocking cover panel
6. Cuvette holder
7. ON/OFF power button
8. 3.5 mm TRRS (jack) input for digital electrodes
9. Standard USB host connector for data transfer to a USB flash drive
10. Micro-USB device connector for power or PC interface

Keypad Description

The keypad contains 12 direct keys and 3 functional keys with the following functions:

-  Press the functional key to perform the function displayed above it on the LCD.
-  Press to access the list of photometer methods.
-  Press to move up in a menu or a help screen, to increment a set value or to access second level functions.
-  Press to toggle between photometer and probe (pH electrode) mode.
-  Press to move left in a menu or to decrement a set value.
-  Press to move down in a menu or a help screen, to decrement a set value or to access second level functions.
-  Press to move right in a menu or to increment a set value.
-  Press to access the setup screen.
-  Press to log the current reading.
-  Press to review saved logs.
-  Press to exit the current screen.
-  Press to display the help screen.
-  ON/OFF power button

5.4. Principle of Operation

Absorption of light is a typical phenomenon of interaction between electromagnetic radiation and matter. When a light beam crosses a substance, some of the radiation may be absorbed by atoms, molecules or crystal lattices. Photometric chemical analysis is based on specific chemical reactions between a sample and reagent to produce a light-absorbing compound.

If pure absorption occurs, the fraction of light absorbed depends both on the optical path length through the matter and on the physical-chemical characteristics of the substance according to the Lambert-Beer Law. If all other factors are constant, the concentration "c" can be calculated from the absorbance of the substance.

Lambert Beer Law:

$$-\log I/I_o = \epsilon_{\lambda} c d$$

or

$$A = \epsilon_{\lambda} c d$$

- I_o = intensity of incident light beam
 I = intensity of light beam after absorption
 ϵ_{λ} = molar extinction coefficient at wavelength λ
 c = molar concentration of the substance
 d = optical path through the substance

5.5. Optical System

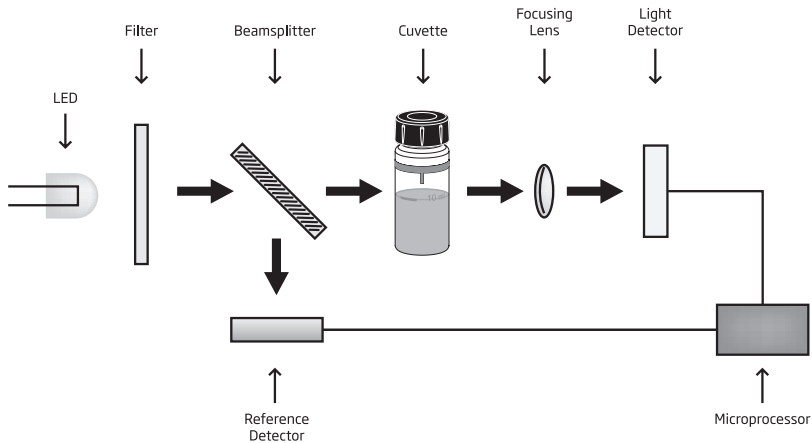

Instrument Block Diagram

The internal reference system (reference detector) of the [HI83399](#) photometer compensates for any drifts due to power fluctuations or ambient temperature changes, providing a stable source of light for your blank (zero) measurement and sample measurement.

LED light sources offer superior performance compared to tungsten lamps. LEDs have a much higher luminous efficiency, providing more light while using less power. They also produce little heat, which could otherwise affect electronic stability. LEDs are available in a wide array of wavelengths, whereas tungsten lamps have poor blue / violet light output.

Improved optical filters ensure greater wavelength accuracy and allow a brighter, stronger signal to be received. The end result is higher measurement stability and less wavelength error.

A focusing lens collects all of the light that exits the cuvette, eliminating errors from cuvette imperfections and scratches, eliminating the need to index the cuvette.

6. GENERAL OPERATIONS

6.1. Power Connection & Battery Management

The meter can be powered from an AC/DC adapter (included) or from the built-in rechargeable battery. The meter will perform an auto-diagnostic test when it is first powered on. During this test, the Hanna Instruments® logo will appear on the LCD. After 5 seconds, if the test was successful, the last method used will appear on the display.

The battery icon on the LCD will indicate the battery status:

- battery is charging from external adapter
- battery fully charged (meter connected to AC/DC adapter)

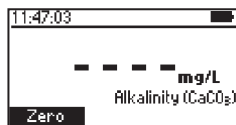
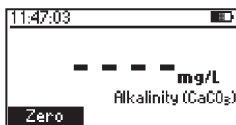

- battery capacity (no external adapter)
- battery near 0% (no external adapter)

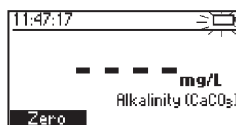
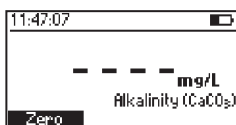

- battery exhausted (no external adapter)



To conserve battery, the meter will turn off automatically after 15 minutes of inactivity (30 minutes after a Zero measurement). If a photometer measurement is on the screen, an auto-log is created before shutdown.

6.2. Mode Selection

The HI83399 has two operational modes: Photometer and Probe.

Photometer mode enables on-demand measurement of a cuvette using the integrated optical system.

Probe mode enables continuous measurement using a Hanna® digital electrode connected to the 3.5 mm port.

To switch between Photometer mode and Probe mode, use the **MODE** key.

Note: The active mode cannot be switched while in Setup, Recall, or Method menus.

6.3. General Setup

Press the **SETUP** key to enter in **Setup** menu, highlight desired option using the ▲▼ keys and press **Select**.

CAL Check™ (Photometer Mode Only)

Press **Select** to enter the CAL Check screen. The date, time and values for the last CAL Check are displayed on the screen. To start a new CAL Check, press **Check** and follow the prompts on the screen. See the Meter Validation & CAL Check™ section for additional information.

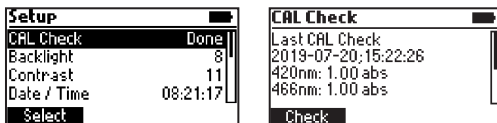

Temperature Unit (Probe Mode Only)

Option: °C or °F

Press the functional key to select the desired temperature unit.

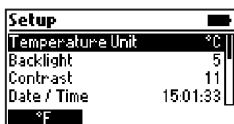

Backlight

Values: 0 to 8

Press **Modify** to access the backlight intensity. Use the functional keys or the ◀▶ keys to increase or decrease the value. Press **Accept** to confirm or press the **ESC** key to return to the **Setup** menu without saving the new value.

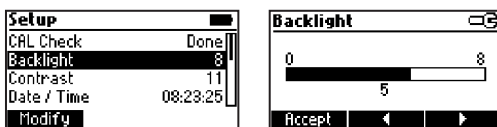

Contrast

Values: 0 to 20

Press **Modify** to change the display's contrast. Use the functional keys or the ◀▶ keys to increase or decrease the value. Press **Accept** to confirm the value or the **ESC** key to return to the **Setup** menu without saving the new value.

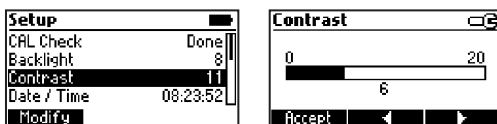

Date & Time

Press **Modify** to change the date and time. Press the functional keys or the ◀▶ keys to highlight the value to be modified (year, month, day, hour, minute or second). Use the ▲▼ keys to change the value. Press **Accept** to confirm or **ESC** key to return to the **Setup** without saving the new date or time.

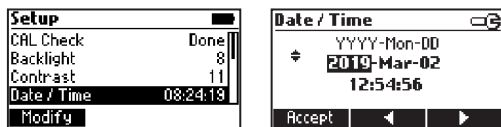

Time Format

Option: AM/PM or 24-hour

Press the functional key to select the desired time format.

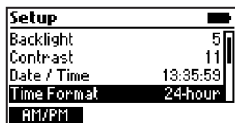

Date Format

Option: DD/MM/YYYY, MM/DD/YYYY, YYYY/MM/DD, YYYY-MM-DD, Mon DD, YYYY, DD-Mon-YYYY, YYYY-Mon-DD

Press **Modify** to change the date format. Use the ▲▼ keys to select the desired format. Press **Select** to confirm or the **ESC** key to return to the **Setup** menu without saving the new format.

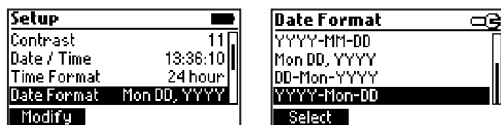

Decimal Separator

Option: Comma (,) or Period (.)

Press the functional key to select the desired decimal separator. The decimal separator is used on the measurement screen and CSV (Comma-Separated Values) files.

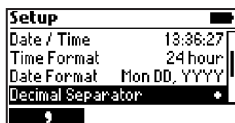

Language

Option: Português, Deutsch, English, Español, Français, Italiano, Dutch

Press **Modify** to change the language. Use the ▲▼ keys to select the desired language. Press **Select** to change the language.



Beeper

Option: Enable or Disable

When enabled, a short beep is heard every time a key is pressed. A long beep alert sounds when the pressed key is not active or an error is detected. Press the functional key to enable or disable the beeper.

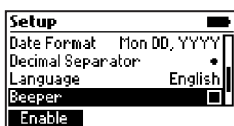

Instrument ID

Option: 0 to 999999

This option is used to set the instrument's ID (identification number). Press **Modify** to access the instrument ID screen. Use the functional keys or the ◀▶ keys to highlight the digit to be modified. Press the ▲▼ keys in order to set the desired value. Press **Accept** to confirm the value or press the ESC key to return to the **Setup** menu without saving the new value.



Meter Information

Press **Select** to view the model, serial number, firmware version and selected language. Press the ESC key to return to the **Setup** menu.

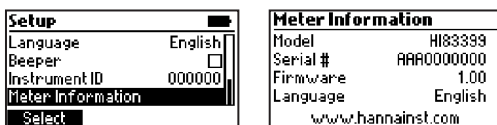

Probe Information (pH Mode Only)

Press **Select** to view model number, serial number and firmware version for the connected probe. Press the **ESC** key to return to the **Setup** menu.

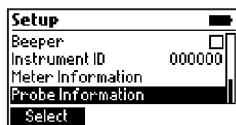

6.4. Contextual Help

HI83399 offers an interactive contextual help mode that assists the user at any time.

To access the help screen press the **HELP** key. The instrument will display additional information related to the current screen. To read all the available information, scroll the text using the **▲▼** keys. Press the **ESC** key to return to the previous screen.

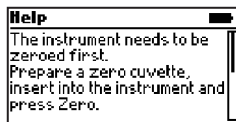

7. LOGGING DATA & DATA MANAGEMENT

The instrument features a data log function to help users keep track of all data analysis. The data log can hold 1000 individual measurements. Storing, viewing and deleting the data is possible using the **LOG** and **RECALL** keys.

7.1. Logging Data

Press the **LOG** key and the last valid measurement will be stored with a date and time stamp. Only valid measurements can be stored.



7.2. Adding Sample & User Names to Log Data

A sample ID and user ID can be added to the saved log. Use the **▲▼** keys to highlight the Sample ID or User ID then press **Modify**. Sample ID and user ID are entered using the alphanumeric multi-tapping keypad.

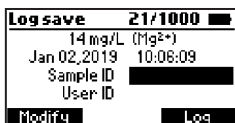

Enter one character at a time by pressing the key with the assigned character repeatedly until the desired character is highlighted. For reference, a list of the characters available for the current key will be shown under the text box.

The character will be entered after a two-second delay or after another key is pressed.

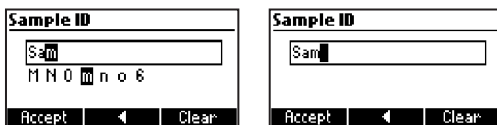

Press **Accept** to update the sample or user ID.

Press **◀** functional key to delete the last character.

Press **Clear** to delete all of the characters.

Press the **ESC** key to discard all changes and return to the previous screen.

7.3. Data Management

Viewing & Deleting

Data can be viewed, deleted and exported to a USB drive or a PC by pressing the **RECALL** key.

Use the **▲▼** keys to scroll through the saved logs.

Press **Info** to view additional information about the selected log.

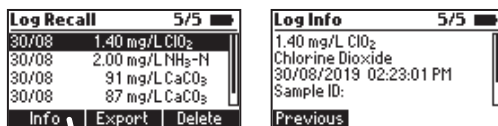

Use **Delete** to erase logged data. After pressing **Delete** the prompt on the display will confirm the action.



Press **No** or the **ESC** key to return to the previous screen.

Press **Yes** to delete the selected log.

Press **Del All** to erase all the logged data. If **Del All** is pressed the prompt on the display will confirm the action.

Press **Yes** to delete all logged data, **No** or the **ESC** key to return to the log recall.

Data Export

Log data can be exported to a USB flash drive or to a PC. To access data export functions, press the **RECALL** key then **Export**.

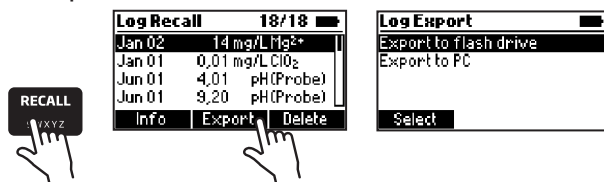

Use the **▲▼** keys to select the desired export location.

For export to flash drive, insert the USB flash drive into the dedicated port at the back of the meter labeled **HOST USB**, then follow the on-screen prompts.

For export to PC, connect the meter to a PC using the supplied micro-USB cable. Insert the cable into the port at the back of the meter labeled **PC PWR**. Follow the on-screen prompts. When the meter says **PC connected**, the meter will appear as a removable disk. Use a file manager (such as Windows Explorer or Mac Finder) to move the file from the meter to the PC.

Log data is exported as a single file (**HI83399.csv**) containing all logged photometer and probe data. The CSV file may be opened with a text editor or spreadsheet application.

8. PHOTOMETER MODE

8.1. Method Selection

In order to select the desired method press the **METHOD** key and a screen with the available methods will appear.

Press the ▲▼ keys to highlight the desired method. Press **Select**.

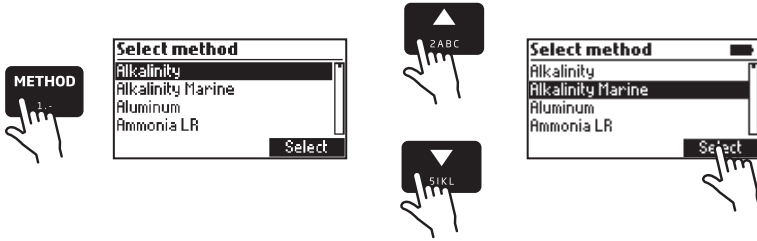

After the desired method is selected, follow the procedure described in the related section. Before performing a method, read all the instructions carefully.

8.2. Collecting & Measuring Samples and Reagents

Proper Use of Syringe

1. Push the plunger completely into the syringe and insert the tip into the solution.
2. Pull the plunger up until the lower edge of the seal is exactly on the mark for the desired volume.
3. Take out the syringe and clean the outside of the syringe tip, be sure that no drops are hanging on the tip of the syringe. Then, keeping the syringe in a vertical position, push the plunger down into the syringe, the desired volume has been delivered.

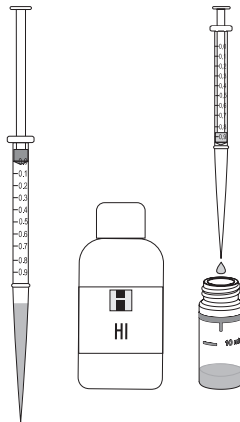

Proper Use of Dropper Bottle

1. Tap the dropper on the table several times.
2. Remove the cap and wipe the outside of the tip with a cloth.
3. Keep the dropper bottle in a vertical position while dosing the reagent.

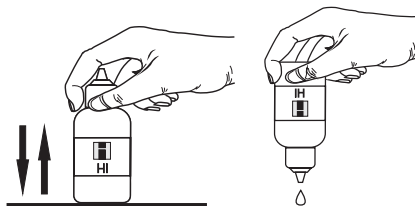

Proper Use of Powder Packet

1. Use scissors to open the powder packet.
2. Push the edges of the packet to form a spout.
3. Pour out the content of the packet.

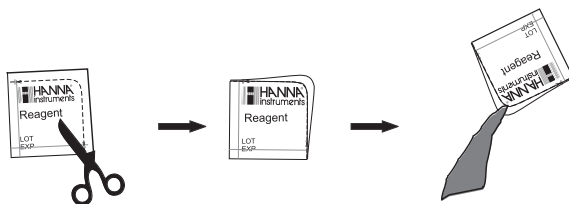

8.3. Cuvette Preparation

Proper mixing is very important for reproducibility of the measurements. The proper mixing technique for each method is listed in the method procedure.

- (a) Invert the cuvette a couple of times or for a specified time: hold the cuvette in the vertical position. Turn the cuvette upside-down and wait for all of the solution to flow to the cap end, then return the cuvette to the upright vertical position and wait for all of the solution to flow to the cuvette bottom. This is one inversion. The correct speed for this mixing technique is 10 to 15 complete inversions in 30 seconds. This mixing technique is indicated with “invert to mix” and one of the following icons:

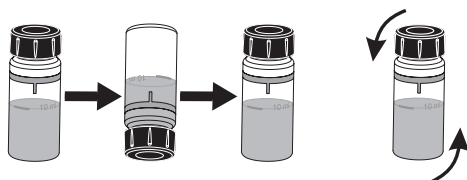

- (b) Shaking the cuvette, moving the cuvette up and down. The movement may be gentle or vigorous. This mixing technique is indicated with “shake gently” or “shake vigorously”, and one of the following icons:

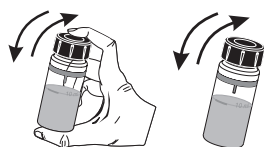

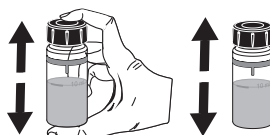

shake gently

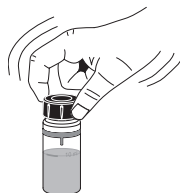

shake vigorously

- (c) Swirl the cuvette gently to mix the solution. This mixing technique is indicated with one of the following icons:



In order to avoid reagent leaking and to obtain more accurate measurements, close the cuvette first with the supplied High-Density Polyethylene (HDPE) plastic stopper  and then the black cap.



Whenever the cuvette is placed into the measurement holder, it must be dry outside and free of fingerprints, oil and dirt. Wipe it thoroughly with [HI731318](#) microfiber cleaning cloth or a lint-free wipe prior to insertion. Shaking the cuvette can generate bubbles in the sample, causing higher readings. To obtain accurate measurements, remove such bubbles by swirling or by gently tapping the cuvette.

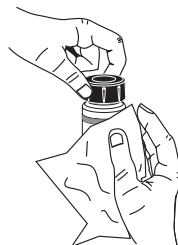

Do not let the reacted sample stand too long after reagent is added. For best accuracy, respect the timings described in each specific method.

It is possible to take multiple readings in a row, but it is recommended to take a new zero reading for each sample and to use the same cuvette for zeroing and measurement when possible.

Discard the sample immediately after the reading is taken, or the glass might become permanently stained.

All the reaction times reported in this manual are at 25 °C (77 °F). In general, the reaction time should be increased for temperatures lower than 20 °C (68 °F) and decreased for temperatures higher than 25 °C (77 °F).

Interferences

In the method measurement section the most common interferences that may be present in a typical water sample have been reported. It is possible that a particular application could introduce other compounds that will also interfere.

8.4. Using the 16 mm Vial Adapter

Some parameters require special single-use 16 mm vials. These parameters can be identified by the "(16)" in the method name and the appearance of "16mm" on the measurement screen.

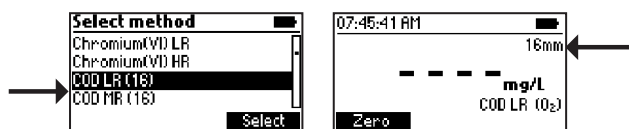

To insert the 16 mm vial adapter:

1. Lift open the meter's sample cover.

Note: *The meter's sample cover will not close completely while using the vial adapter. This is normal – the vial adapter blocks out external light.*

2. Orient the vial adapter with the six small holes toward the bottom.
3. Orient the vial adapter with the indexing mark toward the left. This indexing mark should align with the indexing mark located on the meter.
4. Insert the adapter slowly into the cuvette holder of the meter keeping the index marks on the adapter and meter aligned with each other. If the adapter appears blocked, it may need to be rotated slightly in order to correctly engage the guides in the meter's cuvette holder.

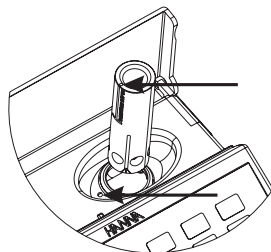

- Using light pressure, push the adapter down until it reaches the bottom of the meter's cuvette holder. When the vial adapter reaches the bottom, users should no longer be able to see the notched area of the adapter.

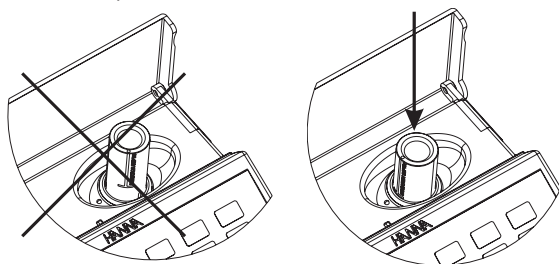

The meter is ready for use with 16 mm vial parameters. Always use the vial adapter for both Zero and Read measurements as specified in the parameter instructions.

Warning: Improper use of the 16 mm vial adapter could cause irreversible damage to the meter. Always use the following precautions while using the 16 mm vial adapter:

- Never use excessive force to insert the adapter. Users should be able to insert the vial with light pressure using one finger. If the vial is not reaching the bottom, if there is resistance, or in case of a "light low" error during the "Zero" operation, re-check that the indexing marks are aligned on the adapter and meter.
- Never insert hot vials or samples into the vial adapter. Samples should be near room temperature before inserting into the meter or adapter.
- Do not attempt to close the sample cover while using the 16 mm vials or adapter. It is normal for the vials or adapter to prevent the cover from closing completely.

8.5. Timers & Measurement Functions

Each method requires a different preparation procedure, reaction times and sample preparations. If a timer or timers are necessary for proper sample preparation, the **Timer** will be available.

To use a reaction timer, press **Timer**. The default timer will start immediately. To stop and reset the timer, press **Stop**.

If the selected method requires more than one timer, the meter will automatically select each timer in the appropriate order. To bypass the default order, you may press the desired key to activate a different timer (only while the current timer is stopped). Press **Continue** to start the active timer.

For some methods, the timer is only necessary after a Zero measurement has been performed. In this case, the timer key will only be available after the Zero measurement has been performed.

If the method requires a Zero or Read measurement after a timer has expired, the meter will automatically perform the appropriate action. Follow the instructions in the method procedure.

To perform a Zero or Read measurement, insert the prepared cuvette, then press **Zero** or **Read**. A Zero measurement must be conducted before a Read measurement.

8.6. Chemical Formula & Unit Conversion

Chemical formula and unit conversion factors are pre-programmed into the instrument and are method specific. In order to view the displayed result in the desired chemical formula press the ▲▼ keys to access the second level function and then press **Chem Frm** to toggle between the available chemical formulas for the selected method.

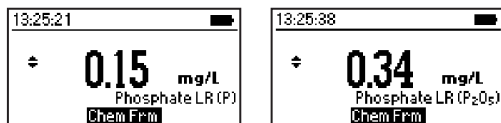

8.7. Meter Validation & CAL Check™

Warning: Do not validate the meter with standard solutions other than the Hanna Instruments® CAL Check Standards. For accurate validation results, please perform tests at room temperature, 18 to 25 °C (64 to 77 °F).

Validation of the HI83399 involves absorbance measurements of certified Hanna Instruments CAL Check Standards (see the Accessories section). The CAL Check screen guides the user through the measurement of each CAL Check Standard and applies the factory calibration corrections to each measurement. The HI83399 stores the results of the most recent CAL Check measurements which may be viewed on the CAL Check screen. Compare these results with the values printed on the Certificate provided with each Hanna Instruments CAL Check Standards kit.

To perform a validation:

1. Press the **SETUP** key.



2. Highlight **CAL Check**, then press **Select**.

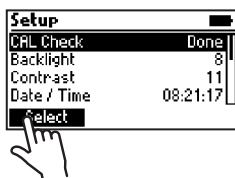

- Follow the prompts on the screen. The meter will prompt to measure each cuvette provided in the Hanna Instruments® CAL Check™ Standards kit. To exit the process at any time, press **ESC** key.

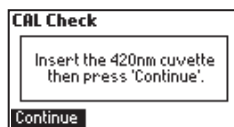
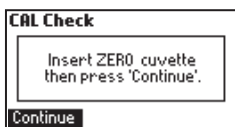
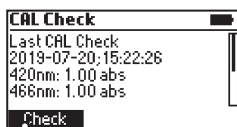

- Press the **ESC** key to return in **Setup** menu.



8.8. Absorbance Measurements

Raw absorbance measurements may be performed on the [HI83399](#) for personal or diagnostic purposes. For example, users may monitor the stability of a reagent blank by occasionally measuring its absorbance versus deionized water.

To measure the raw absorbance of a prepared sample:

- Press the **METHOD** key.
- Highlight the appropriate Absorbance method (according to the wavelength to be used), then press **Select**. Absorbance methods are located at the bottom of the method list.
- Prepare the sample cuvette according to the method.
- Insert a cuvette filled with deionized water, then press **Zero**.
- Insert the prepared sample cuvette, then press **Read**.



Warning: *Never use absorbance methods for validation using Hanna Instruments CAL Check cuvettes. The factory calibration corrections for CAL Check cuvettes are applied while in CAL Check mode only!*

9. PROBE MODE

9.1. pH Measurement

The HI83399 can be used to perform direct pH measurements by connecting a Hanna Instruments® digital pH electrode with a 3.5 mm TRRS connector.

- Connect the electrode to the 3.5 mm port marked with EXT PROBE located at the rear of the meter.
- If the meter is in Photometer mode, set the meter to Probe mode by pressing the **MODE** key.

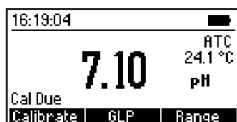

- Press **Calibrate** to open the calibration window.
- Press **GLP** to review the calibration information.
- Press **Range** to switch between pH and mV.

For high accuracy it is recommended to calibrate the electrode often. pH electrodes should be recalibrated at least once per week, but daily calibration is recommended. Always recalibrate after cleaning an electrode, see the pH Calibration section for more information.

To take pH measurements:

1. Remove the protective cap and rinse the electrode with water.
2. Collect some sample in a clean, dry beaker.
3. Preferably, rinse the electrode with a small amount of sample.
4. Submerge the electrode tip approximately 3 cm (1 ¼") into the sample to be tested and stir the sample gently. Make sure the electrode junction is completely submersed.
5. Allow time for the electrode to stabilize in the sample. When the  symbol disappears, the reading is stable.

If measurements are taken successively in different samples, it is recommended to rinse the electrodes thoroughly with deionized or distilled water and then with some of the next sample to prevent cross-contamination.

pH measurements are affected by temperature. Hanna Instruments digital pH electrodes include a built-in temperature sensor and automatically calculate corrected pH values. The measured temperature is displayed on the screen with the pH measurements.

9.2. pH Calibration

- From the probe measurement screen, press **Calibrate** to begin the calibration process. During pH calibration, the display will show the current pH reading, temperature reading, selected buffer type and the buffer number ("Buffer: 1" for the first buffer, "Buffer: 2" for the second buffer).

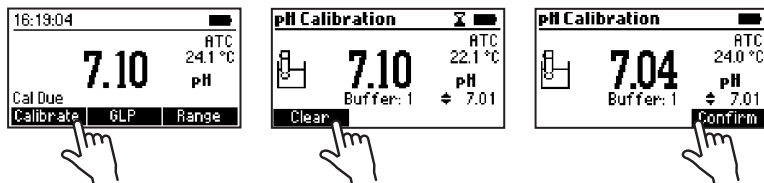

- Press **Clear** to clear the current calibration.
- Press **Confirm** to accept the current calibration point (only available if the reading is stable and within the limits for the selected buffer).
- Press the ▲▼ keys to cycle through the list of available buffers: pH 4.01, 6.86, 7.01, 9.18, 10.01.
- Press the ESC key to exit calibration and return to pH measurement mode.

Preparation

Pour small quantities of the buffer solutions into clean beakers. If possible, use plastic beakers to minimize any EMC interferences. For accurate calibrations and to minimize cross-contamination, use two beakers for each buffer solution: one for rinsing the electrode and one for calibration.

When measuring in the acidic range, use pH 7.01 or 6.86 as the first buffer and pH 4.01 as the second buffer. When measuring in the alkaline range, use pH 7.01 or 6.86 as the first buffer and pH 10.01 or 9.18 as the second buffer.

Procedure

Calibration can be performed using one or two calibration buffers. For more accurate measurements, a two-point calibration is recommended.

- Submerge the pH electrode approximately 3 cm (1 ¼") into a buffer solution and stir gently.
- When the reading is stable and close to the selected buffer, press **Confirm** to accept and store the calibration point. The meter will prompt for the second buffer (Buffer: 2).
- To use only a one-point calibration, press the ESC key to exit calibration mode. The meter will store the calibration information to the probe and return to measurement mode.
- To continue calibrating with a second buffer, rinse and submerge the pH electrode approximately 3 cm (1 ¼") into the second buffer solution and stir gently. If necessary, use the ▲▼ keys to select a different buffer value.
- When the reading is stable and close to the selected buffer, press **Confirm** to accept and store the second calibration point.

The meter will store the two-point calibration information to the probe and return to Measurement mode. The list of calibrated buffers will appear at the bottom of the screen.

9.3. pH Messages & Warnings

No Probe

No probe is connected or the probe is broken.

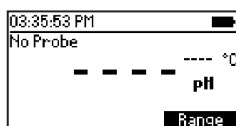

Connecting

The meter has detected a probe and is reading the probe configuration and calibration information.



Incompatible Probe

The connected probe is not compatible with this device.

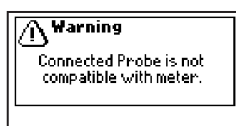

Incompatible Calibration

The probe's current calibration is not compatible with this meter. The calibration must be cleared to use this probe.

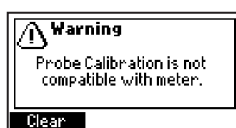

Exceeded Probe Range

The pH and/or temperature measurement exceed the specifications of the probe. The measurement value(s) will be blinking.

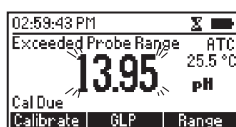

Broken Temperature Sensor

The temperature sensor inside the probe is broken. Temperature compensation will revert to a fixed value of 25 °C (77 °F).

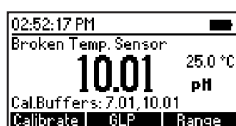

Cal Due

The probe has no calibration. See the pH Calibration section for details.

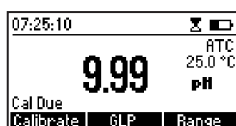

Clean Probe

The offset is outside the accepted window or the slope is under the accepted lower limit. Cleaning the probe will improve the pH electrode's response, repeat the calibration after cleaning. See the pH Electrode Conditioning & Maintenance section for details.

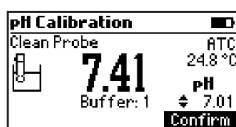

Check Probe & Buffer

There is a large difference between the pH measurement and the selected buffer value or the electrode slope is outside of the accepted slope limit. Clean the probe and confirm the correct buffer selection.

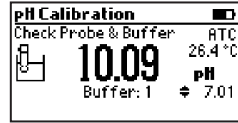

Wrong Temperature

The buffer temperature is outside of the acceptable window for the selected buffer value.

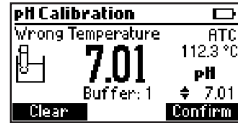

9.4. pH GLP

Good Laboratory Practice (GLP) refers to a quality control function used to ensure uniformity and consistency of sensor calibrations and measurements. To view the GLP information, press the GLP key from the probe measurement screen.

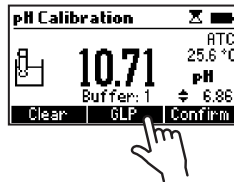

The pH GLP screen displays the date and time, buffers, slope and offset for the last calibration. If the probe has not been calibrated, “No User Calibration” is displayed. Press the ESC key to return to the measurement mode.

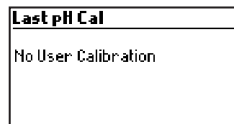
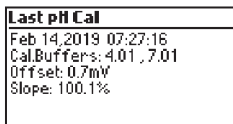

9.5. pH Electrode Conditioning & Maintenance

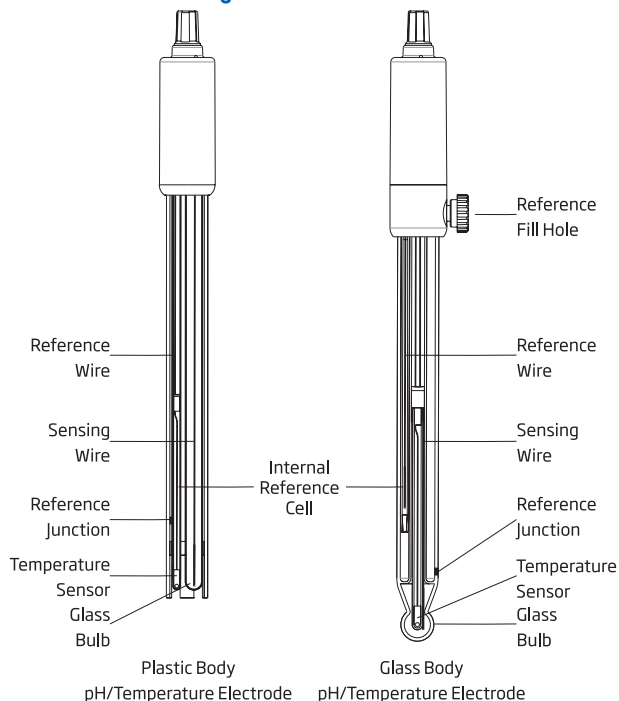

- Remove the protective cap. Do not be alarmed if salt deposits are present, this is normal. Rinse the probe with water.
- Shake the electrode down as you would do with a clinical thermometer to eliminate any air bubbles inside the glass bulb.
- If the bulb and / or junction are dry, soak the electrode in [HI70300](#) or [HI80300](#) Storage solution for a minimum of 30 minutes. Rinse with water.
- Calibrate before using.
- For refillable electrodes if the filling solution (electrolyte) is more than 2 ½ cm (1") below the fill hole, add [HI7082](#) or [HI8082](#) 3.5M KCl Electrolyte solution. Unscrew the fill hole cover during measurements so the liquid reference junction maintains an outward flow of electrolyte.

Storage Procedure

To minimize clogging and ensure a quick response time, the glass bulb and the junction should be kept moist and not allowed to dry out.

Replace the solution in the protective cap with a few drops of [HI70300](#) or [HI80300](#) Storage solution or Filling solution ([HI7082](#) or [HI8082](#) 3.5M KCl Electrolyte solution). pH 4.01 or 7.01 buffer can also be used.

Note: *Never store the electrode in distilled or deionized water.*

Periodic Maintenance

- Inspect the electrode and the cable. The cable used for connection to the instrument must be intact and there must be no points of broken insulation on the cable, connectors must be perfectly clean and dry.
- If there are any scratches or cracks on the electrode stem or bulb, replace the electrode.
- For refillable electrodes, refill the reference chamber with fresh electrolyte (HI7082 or HI8082 3.5M KCl Electrolyte solution). Allow the electrode to stand upright for 1 hour.

Cleaning Procedure

Several cleaning solutions are available:

- General – Soak in Hanna® HI7061 or HI8061 General cleaning solution for approximately 30 minutes.
- Protein – Soak in Hanna HI7073 or HI8073 Protein cleaning solution for 15 minutes.
- Inorganic – Soak in Hanna HI7074 Inorganic cleaning solution for 15 minutes.
- Oil and grease – Rinse with Hanna HI7077 or HI8077 Oil and Fat cleaning solution.

After performing any of the cleaning procedures, rinse the electrode thoroughly with distilled water, refill the reference chamber with fresh electrolyte (refillable electrodes only) and soak the electrode in HI70300 or HI80300 Storage solution for at least 1 hour before taking measurements.

Temperature Correlation for pH Sensitive Glass

Verify the temperature range by reading the limits on electrode's cap. The pH electrode's life is temperature dependent. If constantly cycled between two temperatures, the life of the electrode is drastically reduced.

10. METHOD PROCEDURES

10.1. Alkalinity

SPECIFICATIONS

Range	0 to 500 mg/L (as CaCO ₃)
Resolution	1 mg/L
Accuracy	± 5 mg/L ± 5 % of reading at 25 °C
Light Source	LED with narrow band interference filter @ 610 nm
Method	Colorimetric Method

REQUIRED REAGENTS

Code	Description	Quantity
HI775S	Alkalinity Reagent	1 mL
HI93755-53	Chlorine Removal Reagent	1 drop

REAGENT SETS

HI775-26 Reagents for 25 tests

For other accessories see the Accessories section.

MEASUREMENT PROCEDURE

- Select the **Alkalinity** method using the procedure described in the Method Selection section.

- Fill the cuvette with 10 mL of unreacted sample (up to the mark).
Replace the plastic stopper and the cap.



- Insert the cuvette into the holder and close the lid.

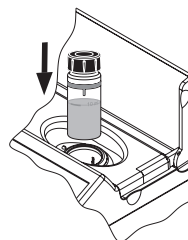

- Press **Zero**. The display will show “-0.0-” when the meter is zeroed and ready for measurement.

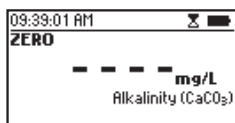
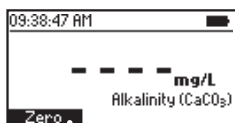

- Remove the cuvette.

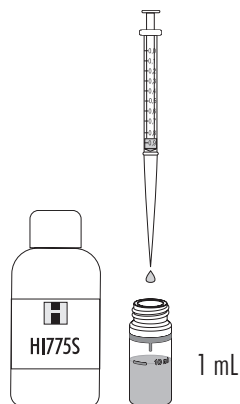

- Add 1 mL of **HI775S** Alkalinity Reagent to the sample using a 1 mL syringe.

- Replace the plastic stopper and the cap. Invert 5 times.



- Insert the cuvette into the holder and close the lid.

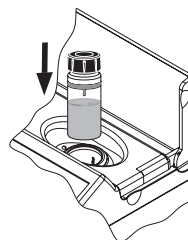

- Press **Read** to start the reading. The instrument displays the results in **mg/L calcium carbonate (CaCO₃)**.

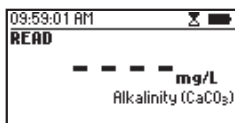

INTERFERENCES

Interference may be caused by:

- Chlorine must be absent, to remove the interference add one drop of **HI93755-53** Chlorine Removal Reagent to the unreacted sample

10.2. Alkalinity, Marine

SPECIFICATIONS

Range	0 to 300 mg/L (as CaCO ₃)
Resolution	1 mg/L
Accuracy	± 5 mg/L ± 5 % of reading at 25 °C
Light Source	LED with narrow band interference filter @ 610 nm
Method	Colorimetric Method

REQUIRED REAGENTS

Code	Description	Quantity
HI755S	Alkalinity Reagent	1 mL

REAGENT SETS

HI755-26 Reagents for 25 tests

For other accessories see the Accessories section.

MEASUREMENT PROCEDURE

- Select the *Alkalinity Marine* method using the procedure described in the Method Selection section.

- Fill the cuvette with 10 mL of unreacted sample (up to the mark).
Replace the plastic stopper and the cap.



- Insert the cuvette into the holder and close the lid.

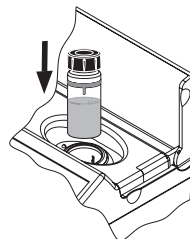

- Press **Zero**. The display will show “-0.0-” when the meter is zeroed and ready for measurement.

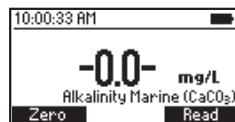
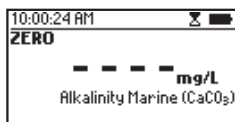
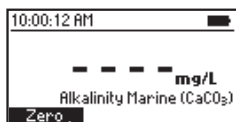

- Remove the cuvette.

- Add 1 mL of HI755S Alkalinity Reagent to the sample using a 1 mL syringe.

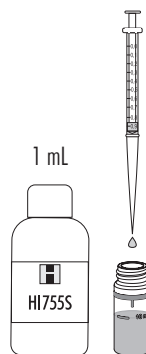

- Replace the plastic stopper and the cap. Invert 5 times.

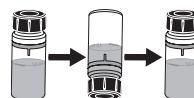

- Insert the cuvette into the holder and close the lid.

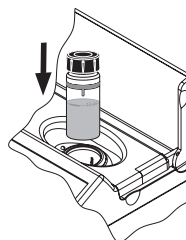

- Press **Read** to start the reading. The instrument displays the results in mg/L as calcium carbonate (CaCO_3).

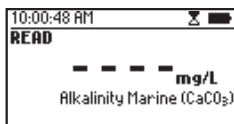

- Press the ▲ or ▼ key to access the second level functions.
- Press **Chem Frm** to convert the result to degree KH (dKH).

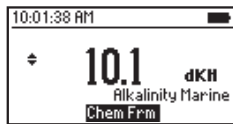

- Press the ▲ or ▼ key to return to the measurement screen.

10.3. Aluminum

SPECIFICATIONS

Range	0.00 to 1.00 mg/L (as Al ³⁺)
Resolution	0.01 mg/L
Accuracy	±0.04 mg/L ±4 % of reading at 25 °C
Light Source	LED with narrow band interference filter @ 525 nm
Method	Adaptation of the Aluminon Method

REQUIRED REAGENTS

Code	Description	Quantity
HI93712A-0	Aluminum Reagent A	1 packet
HI93712B-0	Aluminum Reagent B	1 packet
HI93712C-0	Aluminum Reagent C	1 packet

REAGENT SETS

HI93712-01 Reagents for 100 tests

HI93712-03 Reagents for 300 tests

For other accessories see the Accessories section.

MEASUREMENT PROCEDURE

- Select the **Aluminum** method using the procedure described in the Method Selection section.

- Fill a graduated beaker with 50 mL of sample.



- Add one packet of **HI93712A-0** Aluminum Reagent A and mix until completely dissolved.



- Add one packet of **HI93712B-0** Aluminum Reagent B and mix until completely dissolved.



- Fill two cuvettes with 10 mL of sample (up to the mark).

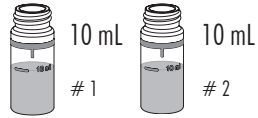

- Add one packet of HI93712C-0 Aluminum Reagent C to one cuvette (#1). Replace the plastic stopper and the cap. Shake gently until completely dissolved. This is the blank.

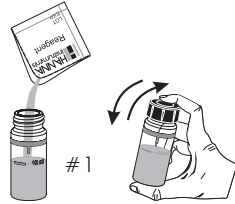

- Insert the first cuvette (#1) into the holder and close the lid.

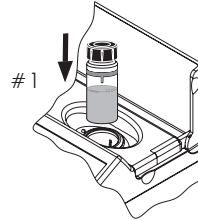

- Press **Timer** and the display will show the countdown prior to the zero or wait 15 minutes and then press **Zero**. The display will show “-0.0-” when the meter is zeroed and ready for measurement.

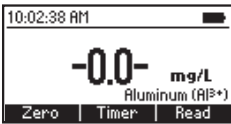
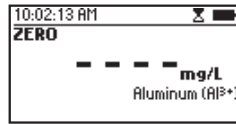
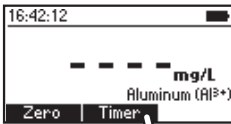

- Remove the blank and insert the second cuvette (#2) into the holder and close the lid.

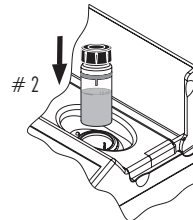

- Press **Read** to start the reading. The instrument displays the results in mg/L of aluminum (Al^{3+}).

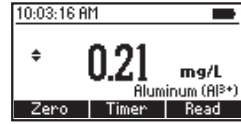
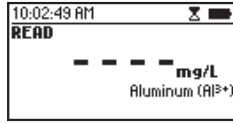
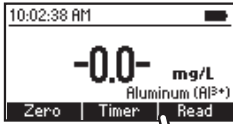

- Press the ▲ or ▼ key to access the second level functions.
- Press **Chem Frm** to convert the result to mg/L of aluminum oxide (Al_2O_3).

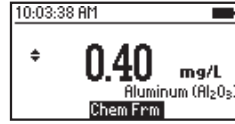
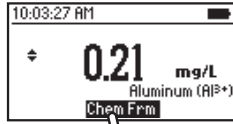

- Press the ▲ or ▼ key to return to the measurement screen.

INTERFERENCES

Interference may be caused by:

- Alkalinity above 1000 mg/L
- Phosphate above 50 mg/L
- Iron above 20 mg/L
- Fluoride must be absent. If the fluoride concentration is known, the aluminum concentration can be determined using the graph below:

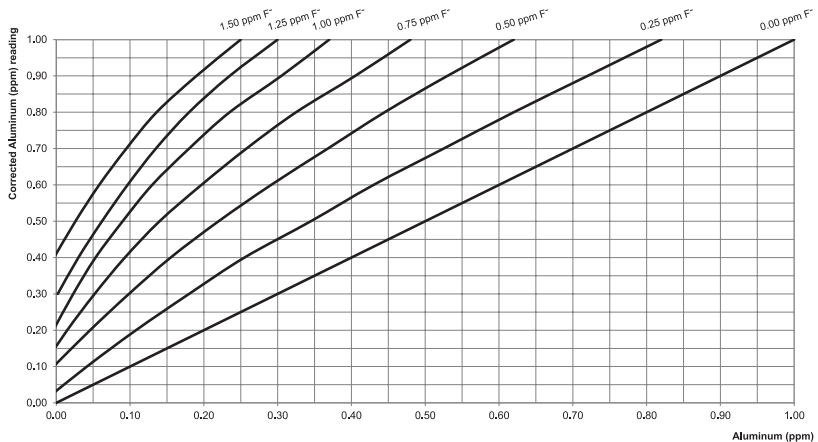

To use the fluoride interference graph:

1. Follow the measurement procedure to obtain the aluminum concentration.
2. Locate the aluminum reading on x-axis.
3. Follow the line up, until it intersects the fluoride curve corresponding to the fluoride concentration in the sample.
4. From the intersection of the fluoride and aluminum line, follow the line to the left until it intersects the y-axis. This point corresponds to the corrected aluminum concentration in the sample.

E.g. Aluminum reading on meter 0.40 ppm and fluoride content in sample 0.50 ppm, corrected aluminum concentration in sample is 0.75 ppm.

10.4. Ammonia Low Range

SPECIFICATIONS

Range	0.00 to 3.00 mg/L (as NH ₃ -N)
Resolution	0.01 mg/L
Accuracy	±0.04 mg/L ± 4 % of reading at 25 °C
Light Source	LED with narrow band interference filter @ 420 nm
Method	Adaptation of the ASTM Manual of Water and Environmental Technology, D1426 Nessler Method

REQUIRED REAGENTS

Code	Description	Quantity
HI93700A-0	Ammonia Low Range Reagent A	4 drops
HI93700B-0	Ammonia Low Range Reagent B	4 drops

REAGENT SETS

HI93700-01 Reagents for 100 tests

HI93700-03 Reagents for 300 tests

For other accessories see the Accessories section.

MEASUREMENT PROCEDURE

- Select the [Ammonia LR](#) method using the procedure described in the Method Selection section.

- Fill the cuvette with 10 mL of unreacted sample (up to the mark).
Replace the plastic stopper and the cap.



- Insert the cuvette into the holder and close the lid.

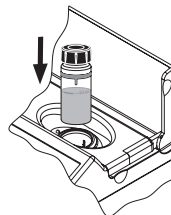

- Press **Zero**. The display will show “-0.0-” when the meter is zeroed and ready for measurement.

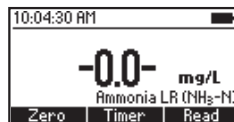
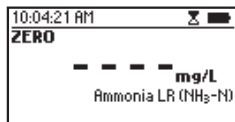
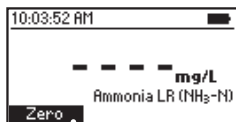

- Remove the cuvette.
- Add 4 drops of **HI93700A-0** Ammonia Low Range Reagent A. Replace the plastic stopper and the cap. Swirl to mix the solution.

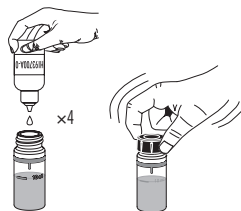

- Add 4 drops of **HI93700B-0** Ammonia Low Range Reagent B. Replace the plastic stopper and the cap. Swirl to mix the solution.

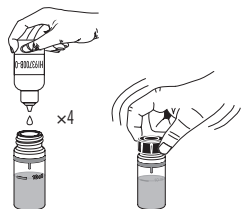

- Insert the cuvette into the holder and close the lid.

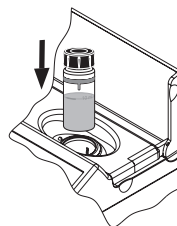

- Press **Timer** and the display will show the countdown prior to the measurement or wait 3 minutes and 30 seconds and press **Read**. When the timer ends the meter will perform the reading. The instrument displays the results in **mg/L of ammonia nitrogen (NH₃-N)**.

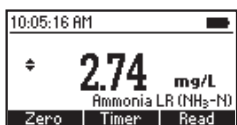
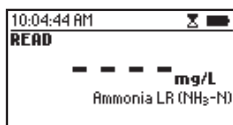
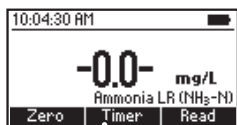

- Press the **▲** or **▼** key to access the second level functions.

- Press **Chem Frm** to convert the result to **mg/L** of **ammonia (NH₃)** and **ammonium (NH₄⁺)**.

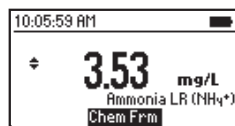
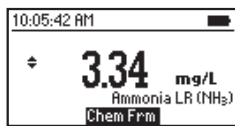
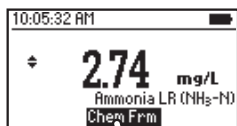

- Press the **▲** or **▼** key to return to the measurement screen.

INTERFERENCES

Interference may be caused by:

- Hardness above 1 g/L
- Iron
- Sulfide may cause turbidity
- Organic compounds like acetone above 0.1 %, alcohols, aldehydes, aliphatic and aromatic amines, chloramines, glycine, or urea above 10 mg/L, to remove the interference distillation is required

10.5. Ammonia Low Range (16 mm Vial)

SPECIFICATIONS

Range	0.00 to 3.00 mg/L (as NH ₃ -N)
Resolution	0.01 mg/L
Accuracy	± 0.10 mg/L or ± 5 % of reading at 25 °C, whichever is greater
Light Source	LED with narrow band interference filter @ 420 nm
Method	Adaptation of the ASTM Manual of Water and Environmental Technology, D1426 Nessler Method

REQUIRED REAGENTS

Code	Description	Quantity
HI93764A-0*	Ammonia Low Range Reagent Vial	1 vial
HI93764-0	Nessler Reagent	4 drops

*Reagent vial identification: A LR, white label

REAGENT SETS

HI93764A-25 Reagents for 25 tests

For other accessories see the Accessories section.

Note: Store the unused vials in their packaging in a cool and dark place.

MEASUREMENT PROCEDURE

- Select the **Ammonia LR (16)** method following one of the procedures described in the Method Selection section.
- Insert the 16 mm vial adapter using the procedure described in the Using the 16 mm Vial Adapter section.
- Remove the cap from HI93764A-0 Ammonia Low Range Reagent Vial.
- Add 5 mL of sample to the vial, while keeping the vial at a 45-degree angle.
- Replace the cap and invert several times to mix.
- Insert the vial into the holder.

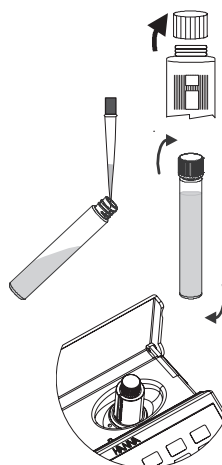

- Press **Zero**. The display will show “-0.0-” when the meter is zeroed and ready for measurement.

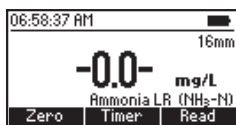
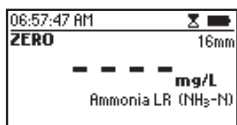
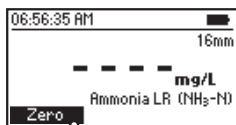

- Remove the vial.
- Remove the cap and add 4 drops of **HI93764-0** Nessler Reagent.
- Replace the cap and invert the vial several times to mix.

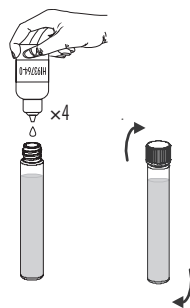

- Insert the vial into the holder.

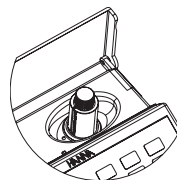

- Press **Timer** and the display will show the countdown prior to the measurement or wait 3 minutes and 30 seconds and press **Read**. When the timer ends the meter will perform the reading. The instrument displays the results in **mg/L ammonia nitrogen (NH₃-N)**.

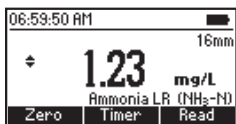
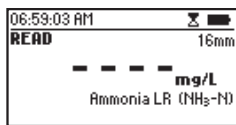
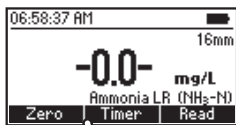

- Press the ▲ or ▼ key to access the second level functions.
- Press Chem Frm to convert the result to mg/L of ammonia (NH_3) and ammonium (NH_4^+).

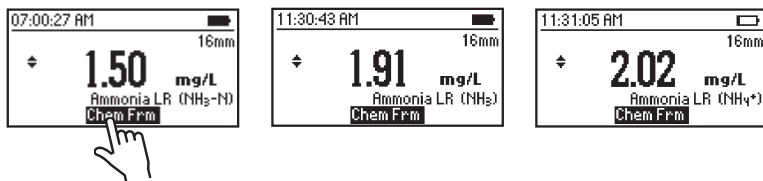

- Press the ▲ or ▼ key to return to the measurement screen.

INTERFERENCES

Interference may be caused by:

- Hardness above 1 g/L
- Iron
- Sulfide may cause turbidity
- Organic compounds like acetone above 0.1 %, alcohols, aldehydes, aliphatic and aromatic amines, chloramines, glycine, or urea above 10 mg/L, to remove the interference distillation is required

10.6. Ammonia Medium Range

SPECIFICATIONS

Range	0.00 to 10.00 mg/L (as NH ₃ -N)
Resolution	0.01 mg/L
Accuracy	±0.05 mg/L ± 5 % of reading at 25 °C
Light Source	LED with narrow band interference filter @ 420 nm
Method	Adaptation of the ASTM Manual of Water and Environmental Technology, D1426, Nessler Method

REQUIRED REAGENTS

Code	Description	Quantity
HI93715A-0	Ammonia Medium Range Reagent A	4 drops
HI93715B-0	Ammonia Medium Range Reagent B	4 drops

REAGENT SETS

HI93715-01 Reagents for 100 tests

HI93715-03 Reagents for 300 tests

For other accessories see the Accessories section.

MEASUREMENT PROCEDURE

- Select the **Ammonia MR** method using the procedure described in the Method Selection section.

- Fill the cuvette with 10 mL of unreacted sample (up to the mark).
Replace the plastic stopper and the cap.



- Insert the cuvette into the holder and close the lid.

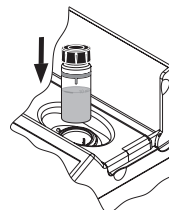

- Press **Zero**. The display will show “-0.0-” when the meter is zeroed and ready for measurement.

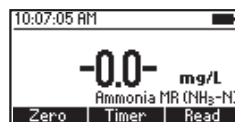
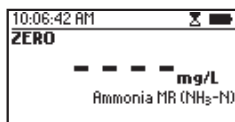
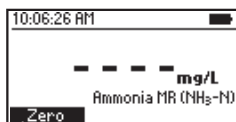

- Remove the cuvette.

- Add 4 drops of **HI93715A-0** Ammonia Medium Range Reagent A. Replace the plastic stopper and the cap. Swirl to mix the solution.

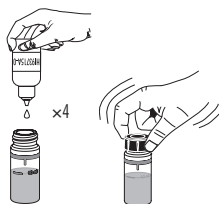

- Add 4 drops of **HI93715B-0** Ammonia Medium Range Reagent B. Replace the plastic stopper and the cap. Swirl to mix the solution.

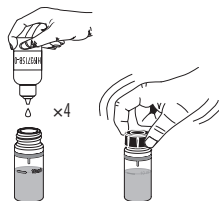

- Insert the cuvette into the holder and close the lid.

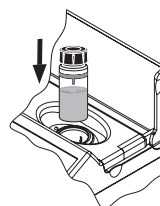

- Press **Timer** and the display will show the countdown prior to the measurement or wait 3 minutes and 30 seconds and press **Read**. When the timer ends the meter will perform the reading. The instrument displays the results in **mg/L of ammonia nitrogen (NH₃-N)**.

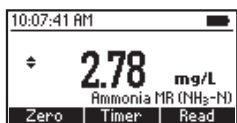
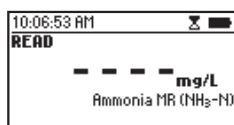
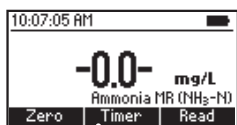

- Press the **▲** or **▼** key to access the second level functions.

- Press **Chem Frm** to convert the result to mg/L of ammonia (NH_3) and ammonium (NH_4^+).

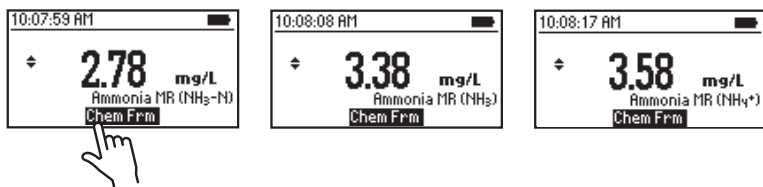

- Press the **▲** or **▼** key to return to the measurement screen.

INTERFERENCES

Interference may be caused by:

- Hardness above 1 g/L
- Iron
- Sulfide may cause turbidity
- Organic compounds like acetone above 0.1 %, alcohols, aldehydes, aliphatic and aromatic amines, chloramines, glycine, or urea above 10 mg/L, to remove the interference distillation is required

10.7. Ammonia High Range

SPECIFICATIONS

Range	0.0 to 100.0 mg/L (as NH ₃ -N)
Resolution	0.1 mg/L
Accuracy	±0.5 mg/L ±5 % of reading at 25 °C
Light Source	LED with narrow band interference filter @ 420 nm
Method	Adaptation of the ASTM Manual of Water and Environmental Technology, D1426, Nessler Method

REQUIRED REAGENTS

Code	Description	Quantity
HI93733A-0	Ammonia High Range Reagent A	4 drops
HI93733B-0	Ammonia High Range Reagent B	9 mL

REAGENT SETS

HI93733-01 Reagents for 100 tests

HI93733-03 Reagents for 300 tests

For other accessories see the Accessories section.

MEASUREMENT PROCEDURE

- Select the **Ammonia HR** method using the procedure described in the Method Selection section.
- Add 1 mL of unreacted sample to the cuvette using a 1 mL syringe.



- Use the pipette to fill the cuvette up to the 10 mL mark with **HI93733B-0** Ammonia High Range Reagent B. Replace the plastic stopper and the cap. Swirl to mix the solution.

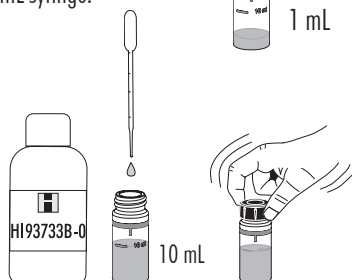

- Insert the cuvette into the holder and close the lid.

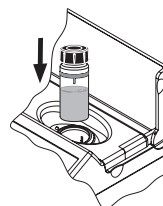

- Press **Zero**. The display will show “-0.0-” when the meter is zeroed and ready for measurement.

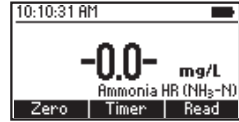
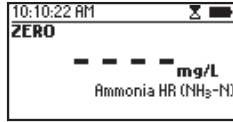
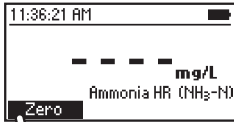

- Remove the cuvette.

- Add 4 drops of **HI93733A-0** Ammonia High Range Reagent A. Replace the plastic stopper and the cap. Swirl to mix the solution.

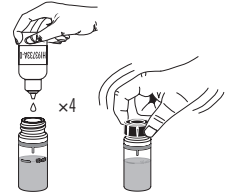

- Insert the cuvette into the holder and close the lid.

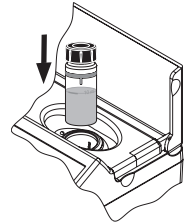

- Press **Timer** and the display will show the countdown prior to the measurement or wait 3 minutes and 30 seconds and press **Read**. When the timer ends the meter will perform the reading. The instrument displays the results in **mg/L of ammonia nitrogen (NH₃-N)**.

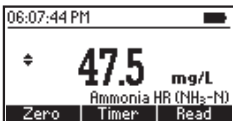
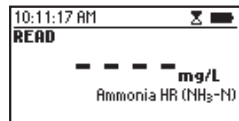
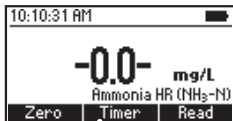

- Press the ▲ or ▼ key to access the second level functions.

- Press Chem Frm to convert the result to mg/L of ammonia (NH_3) and ammonium (NH_4^+).

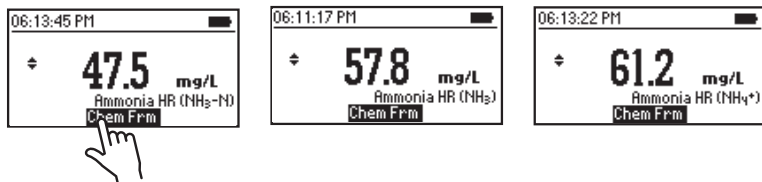

- Press the ▲ or ▼ key to return to the measurement screen.

INTERFERENCES

Interference may be caused by:

- Hardness above 1 g/L
- Iron
- Sulfide may cause turbidity
- Organic compounds like acetone above 0.1 %, alcohols, aldehydes, aliphatic and aromatic amines, chloramines, glycine, or urea above 10 mg/L, to remove the interference distillation is required

10.8. Ammonia High Range (16 mm Vial)

SPECIFICATIONS

Range	0.0 to 100.0 mg/L (as NH ₃ -N)
Resolution	0.1 mg/L
Accuracy	± 1.0 mg/L or ± 5 % of reading at 25 °C, whichever is greater
Light Source	LED with narrow band interference filter @ 420 nm
Method	Adaptation of the ASTM Manual of Water and Environmental Technology, D1426 Nessler Method

REQUIRED REAGENTS

Code	Description	Quantity
HI93764B-0*	Ammonia High Range Reagent Vial	1 vial
HI93764-0	Nessler Reagent	4 drops

*Reagent vial identification: A HR, green label

REAGENT SETS

HI93764B-25 Reagents for 25 tests

For other accessories see the Accessories section.

Note: Store the unused vials in their packaging in a cool and dark place.

MEASUREMENT PROCEDURE

- Select the [Ammonia HR \(16\)](#) method using the procedure described in the Method Selection section.
- Insert the 16 mm vial adapter using the procedure described in the Using the 16 mm Vial Adapter section.
- Remove the cap from [HI93764B-0](#) Ammonia High Range Reagent Vial.
- Add 1 mL of sample to the vial, while keeping the vial at a 45-degree angle.
- Replace the cap and invert several times to mix.

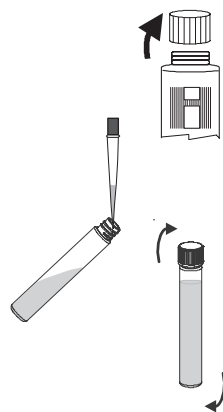

- Insert the vial into the holder.

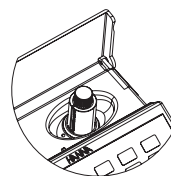

- Press **Zero**. The display will show “-0.0-” when the meter is zeroed and ready for measurement.

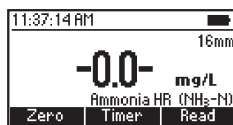
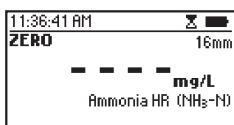
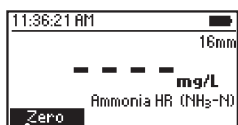

- Remove the vial.
- Add 4 drops of **HI93764-0** Nessler Reagent.
- Replace the cap and invert several times to mix.

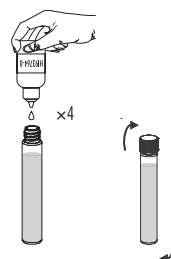

- Insert the vial into the holder.

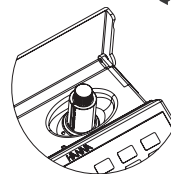

- Press **Timer** and the display will show the countdown prior to the measurement or wait 3 minutes and 30 seconds. When the timer ends the meter will perform the reading. The instrument displays the results in **mg/L ammonia nitrogen (NH₃-N)**.

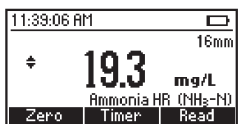
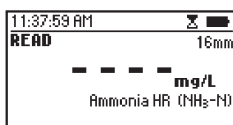
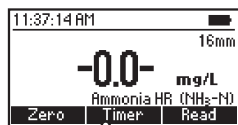

- Press the **▲** or **▼** key to access the second level functions.

- Press **Chem Frm** to convert the result to **mg/L** of **ammonia (NH₃)** and **ammonium (NH₄⁺)**.

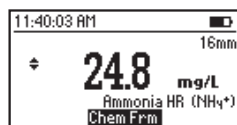
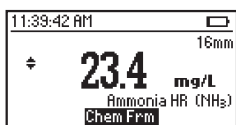
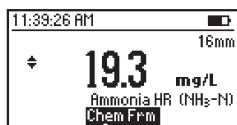

- Press the ▲ or ▼ key to return to the measurement screen.

INTERFERENCES

Interference may be caused by:

- Hardness above 1 g/L
- Iron
- Sulfide may cause turbidity
- Organic compounds like acetone above 0.1 %, alcohols, aldehydes, aliphatic and aromatic amines, chloramines, glycine, or urea above 10 mg/L, to remove the interference distillation is required

10.9. Bromine

SPECIFICATIONS

Range	0.00 to 8.00 mg/L (as Br ₂)
Resolution	0.01 mg/L
Accuracy	±0.08 mg/L ± 3 % of reading at 25 °C
Light Source	LED with narrow band interference filter @ 525 nm
Method	Adaptation of Standard Methods for the Examination of Water and Wastewater, 18 th Edition, DPD Method

REQUIRED REAGENTS

Code	Description	Quantity
HI93716-0	Bromine Reagent	1 packet

REAGENT SETS

HI93716-01 Reagents for 100 tests

HI93716-03 Reagents for 300 tests

For other accessories see the Accessories section.

MEASUREMENT PROCEDURE

- Select the **Bromine** method using the procedure described in the Method Selection section.

- Fill the cuvette with 10 mL of unreacted sample (up to the mark).
Replace the plastic stopper and the cap.



- Insert the cuvette into the holder and close the lid.

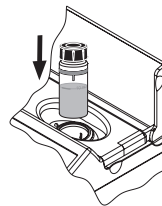

- Press **Zero**. The display will show “-0.0-” when the meter is zeroed and ready for measurement.

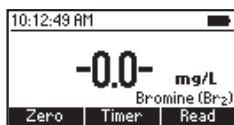
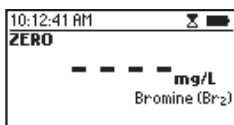
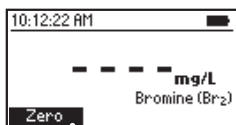

- Remove the cuvette.
- Add one packet of **HI93716-0** Bromine Reagent. Replace the plastic stopper and the cap. Shake gently for about 20 seconds to dissolve most of the reagent.

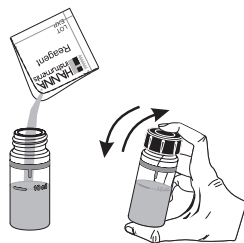

- Insert the cuvette into the holder and close the lid.

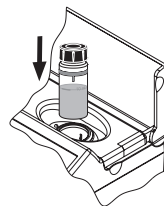

- Press **Timer** and the display will show the countdown prior to the measurement or wait 2 minutes and 30 seconds and press **Read**. When the timer ends the meter will perform the reading. The instrument displays the results in **mg/L of bromine (Br₂)**.

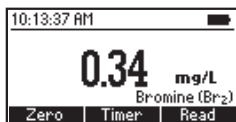
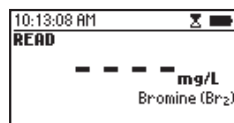
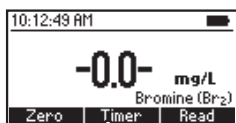

INTERFERENCES

Interference may be caused by:

- Chlorine, Iodine, Ozone, Oxidized forms of Chromium and Manganese
- Hardness greater than 500 mg/L CaCO₃, to remove the interference shake the sample for approximately 1 minute after adding the reagent
- Alkalinity greater than 300 mg/L CaCO₃ or acidity greater than 150 mg/L CaCO₃, the color of the sample may develop only partially or rapidly fade, to remove the interference neutralize the sample with diluted HCl or NaOH

10.10. Calcium

SPECIFICATIONS

Range	0 to 400 mg/L (as Ca ²⁺)
Resolution	1 mg/L
Accuracy	± 10 mg/L ± 5 % of reading at 25 °C
Light Source	LED with narrow band interference filter @ 466 nm
Method	Adaptation of the Oxalate Method

REQUIRED REAGENTS

Code	Description	Quantity
—	Buffer Reagent	4 drops
HI93752A-Ca	Calcium Reagent A	7 mL
HI93752B-Ca	Calcium Reagent B	1 mL

REAGENT SETS

HI937521-01 Reagents for 50 tests

HI937521-03 Reagents for 150 tests

For other accessories see the Accessories section.

MEASUREMENT PROCEDURE

- Select the **Calcium** method using the procedure described in the Method Selection section.

- Add 3 mL of unreacted sample to the cuvette using the 5 mL syringe.



- Use the pipette to fill the cuvette up to the 10 mL mark with the **HI93752A-Ca** Calcium Reagent A.

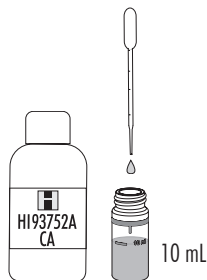

- Add 4 drops of Buffer Reagent.



- Replace the plastic stopper and the cap. Invert several times to mix.

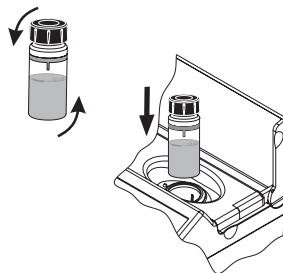

- Insert the cuvette into the holder and close the lid.
- Press **Zero**. The display will show “-0.0-” when the meter is zeroed and ready for measurement.

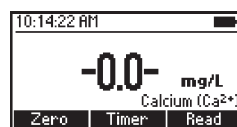
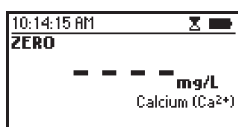
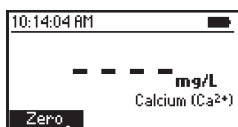

- Remove the cuvette.
- Add 1 mL of **HI93752B-Ca** Calcium Reagent B to the sample using the 1 mL syringe. Replace the plastic stopper and the cap. Invert the cuvette 10 times to mix (about 15 seconds).

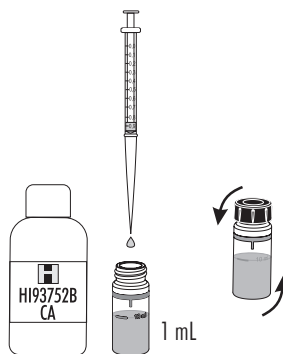

- Insert the cuvette into the holder and close the lid.

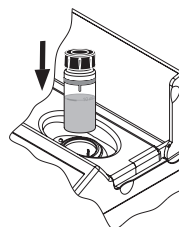

- Press **Timer** and the display will show the countdown prior to the measurement or wait 5 minutes.

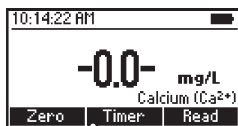

- After waiting 5 minutes, invert the cuvette 10 times to mix (about 15 seconds).

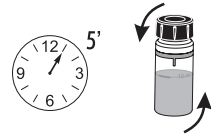

- Insert the cuvette into the holder and close the lid.

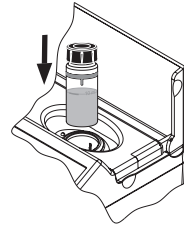

- Press **Read** to start the reading. The instrument displays the results in mg/L of calcium (Ca^{2+}).

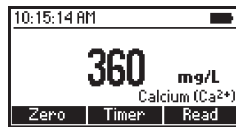
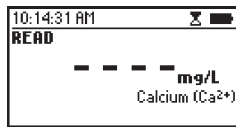
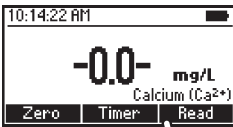

INTERFERENCES

Interference may be caused by:

- Acidity, Alkalinity above 1000 mg/ L CaCO_3
- Magnesium above 400 mg/L

10.11. Calcium, Marine

SPECIFICATIONS

Range	200 to 600 mg/L (as Ca ²⁺)
Resolution	1 mg/L
Accuracy	± 6 % of reading at 25 °C
Light Source	LED with narrow band interference filter @ 610 nm
Method	Adaptation of the Zincon Method

REQUIRED REAGENTS

Code	Description	Quantity
HI7581	Calcium Reagent A	1 mL
HI7582	Calcium Reagent B	1 packet

REAGENT SETS

HI758-26 Reagents for 25 tests
For other accessories see the Accessories section.

MEASUREMENT PROCEDURE

- Select the **Calcium Marine** method using the procedure described in the Method Selection section.

- Add 1 mL of **HI7581** Calcium Reagent A to the cuvette using a 1 mL syringe.

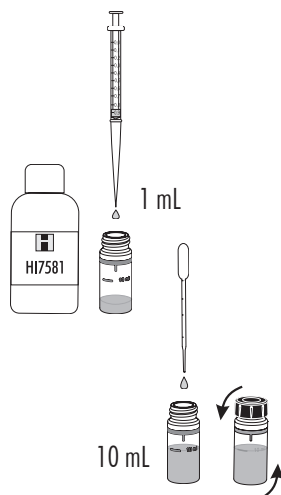

- Use the plastic pipette to fill the cuvette to the 10 mL mark with deionized water. Replace the plastic stopper and the cap. Invert 3 to 5 times to mix.

- Insert the cuvette into the holder and close the lid.

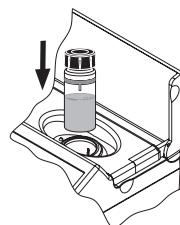

- Press **Zero**. The display will show “-0.0-” when the meter is zeroed and ready for measurement.

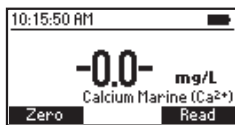
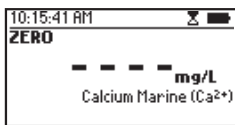
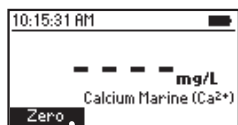

- Remove the cuvette.
- Use the minipipette to add 0.1 mL of sample to the cuvette.



- Add one packet of [H17582](#) Calcium Reagent B. Replace the plastic stopper and the cap and shake vigorously for 15 seconds or until the powder is completely dissolved. Allow air bubbles to dissipate for 15 seconds before taking a reading.

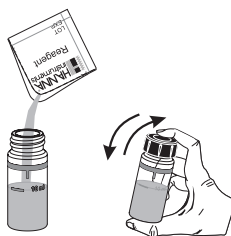

- Insert the cuvette into the holder and close the lid.

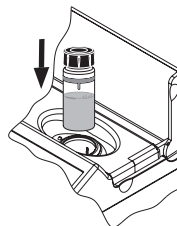

- Press **Read** to start the reading. The instrument displays the results in **mg/L** of calcium (Ca^{2+}).

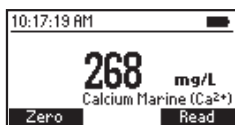
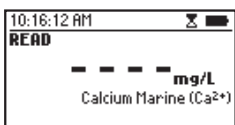
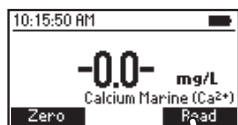

10.12. Chloride

SPECIFICATIONS

Range	0.0 to 20.0 mg/L (as Cl ⁻)
Resolution	0.1 mg/L
Accuracy	±0.5 mg/L ± 6 % of reading at 25 °C
Light Source	LED with narrow band interference filter @ 466 nm
Method	Adaptation of the Mercury(II) Thiocyanate Method

REQUIRED REAGENTS

Code	Description	Quantity
HI93753A-0	Chloride Reagent A	1 mL
HI93753B-0	Chloride Reagent B	1 mL

REAGENT SETS

HI93753-01 Reagents for 100 tests

HI93753-03 Reagents for 300 tests

For other accessories see the Accessories section.

MEASUREMENT PROCEDURE

- Select the **Chloride** method using the procedure described in the Method Selection section.

- Fill one cuvette (#1) with 10 mL of deionized water (up to the mark).



- Fill a second cuvette (#2) with 10 mL of sample (up to the mark).



Note: For samples with low chloride ion concentration, rinse the cuvette a few times with sample before filling it with 10 mL of sample. For the most accurate results, use two graduated pipettes to deliver exactly 10 mL of deionized water and 10 mL of sample to the cuvettes.

- Add 0.5 mL of **HI93753A-0** Chloride Reagent A to each cuvette using the 1 mL syringe.

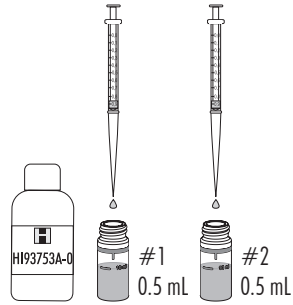

- Replace the plastic stoppers and the caps. Mix each cuvette by inverting for approximately 30 seconds.



- Add 0.5 mL of **HI93753B-0** Chloride Reagent B to each cuvette using the second 1 mL syringe.

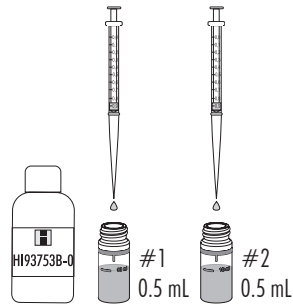

- Replace the plastic stoppers and the caps. Mix each cuvette by inverting for approximately 30 seconds.



- Insert the cuvette with the reacted deionized water (#1) into the holder and close the lid.

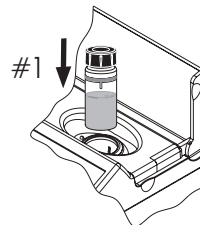

- Press **Timer** and the display will show the countdown prior to the zero or wait 2 minutes and press **Zero**. The display will show "-0.0-" when the meter is zeroed and ready for measurement.

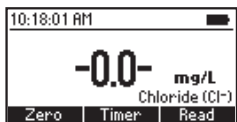
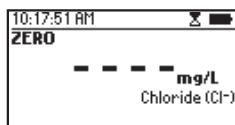
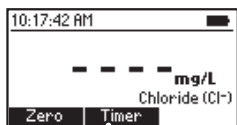

- Remove the cuvette.
- Insert the other cuvette (#2) with the reacted sample into the holder and close the lid.
- Press **Read** to start reading. The instrument displays the results in **mg/L of chloride (Cl⁻)**.

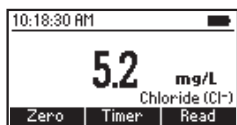
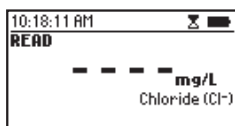
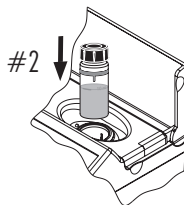

INTERFERENCES

Interference may be caused by:

- Intensely colored samples should be adequately treated before performing the test
- Suspended matter in large amount should be removed by prior filtration
- Alkaline samples, neutralize before adding reagents, the pH of the sample after addition of reagents should be about 2

10.13. Chlorine Dioxide

SPECIFICATIONS

Range	0.00 to 2.00 mg/L (as ClO ₂)
Resolution	0.01 mg/L
Accuracy	±0.10 mg/L ± 5 % of reading at 25 °C
Light Source	LED with narrow band interference filter @ 575 nm
Method	Adaptation of the Chlorophenol Red Method

REQUIRED REAGENT

Code	Description	Quantity
HI93738A-0	Chlorine Dioxide Reagent A	1 mL
HI93738B-0	Chlorine Dioxide Reagent B	1 packet
HI93738C-0	Chlorine Dioxide Reagent C	1 mL
HI93738D-0	Chlorine Dioxide Reagent D	1 mL

REAGENT SETS

HI93738-01 Reagents for 100 tests

HI93738-03 Reagents for 300 tests

For other accessories see the Accessories section.

SAMPLING PROCEDURE

It is recommended to analyze Chlorine Dioxide samples immediately after collection. Chlorine Dioxide samples must be stored in sealed dark glass bottles, with minimal head space. Excessive heat (above 25 °C (77 °F)), agitation and exposure to light must be avoided.

MEASUREMENT PROCEDURE

- Select the [Chlorine Dioxide](#) method using the procedure described in the Method Selection section.
- Fill two graduated mixing cylinders (#1 & #2) up to the 25 mL mark with the sample.

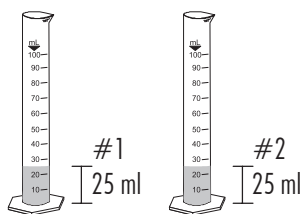

- Add 0.5 mL of **HI93738A-0** Chlorine Dioxide Reagent A to each cylinder (#1 & #2), using a 1 mL syringe, cap them and invert several times to mix.

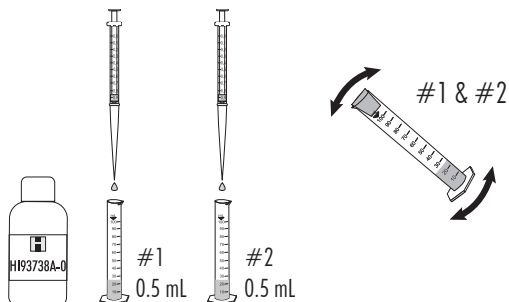

- Add one packet of **HI93738B-0** Chlorine Dioxide Reagent B to one of the two cylinders (#1), cap and invert it several times until it is totally dissolved. This is the blank.

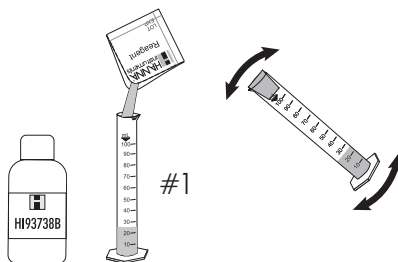

- Add 0.5 mL of **HI93738C-0** Chlorine Dioxide Reagent C to each cylinder (#1 & #2), using a 1 mL syringe, cap them and invert several times to mix.

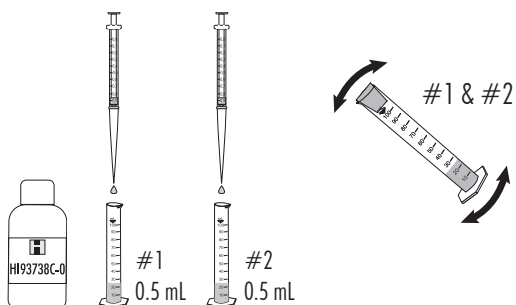

- Add 0.5 mL of **HI93738D-0** Chlorine Dioxide Reagent to each cylinder (#1 & #2), using a 1 mL syringe, cap them and invert several times to mix. Cylinder #2 is the reacted sample.

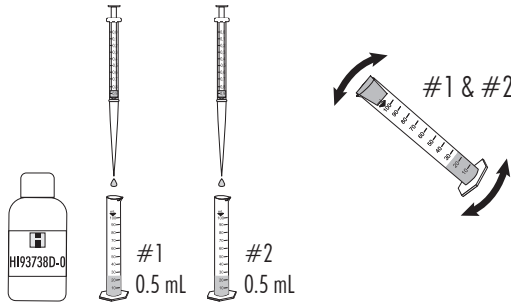

- Fill cuvette (#1) with 10 mL of the blank (up to the mark). Replace the plastic stopper and the cap.

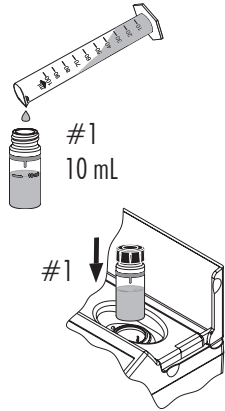

- Insert the blank (#1) into the holder and close the lid.

- Press **Zero**. The display will show “-0.0-” when the meter is zeroed and ready for measurement.

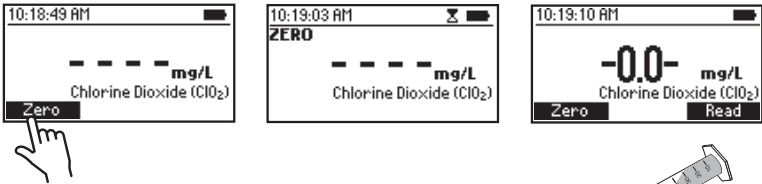

- Fill second cuvette (#2) with 10 mL of the reacted sample (up to the mark). Replace the plastic stopper and the cap.

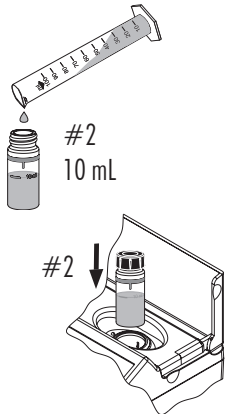

- Insert the sample into the holder and close the lid.

- Press **Read** to start the reading. The instrument displays the results in mg/L of chlorine dioxide (ClO_2).

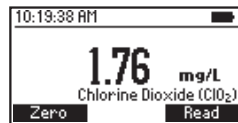
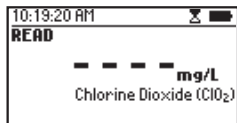
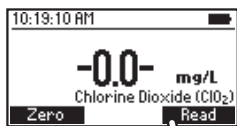

INTERFERENCES

Interference may be caused by:

- Strong oxidants

10.14. Chlorine Dioxide, Rapid Method

SPECIFICATIONS

Range	0.00 to 2.00 mg/L (as ClO ₂)
Resolution	0.01 mg/L
Accuracy	±0.10 mg/L ± 5 % of reading at 25 °C
Light Source	LED with narrow band interference filter @ 525 nm
Method	Adaptation of Standard Methods for the Examination of Water and Wastewater, 18 th Edition, 4500 ClO ₂ D

REQUIRED REAGENT

Code	Description	Quantity
HI96779A-0	Chlorine Dioxide Reagent A	5 drops
HI96779B-0	Chlorine Dioxide Reagent B	1 packet

REAGENT SETS

HI96779-01	Reagents for 100 tests
HI96779-03	Reagents for 300 tests

For other accessories see the Accessories section.

PRINCIPLE

The reaction between the Chlorine Dioxide and DPD indicator causes a pink tint in the sample, the addition of glycine as a masking agent inhibits the response of free chlorine.

APPLICATION

Drinking water, tap water, treated water

SAMPLING PROCEDURE

Collect the sample in a clean glass bottle and analyze it immediately. Chlorine dioxide is a strong oxidizing agent and is unstable in water.

SIGNIFICANCE & USE

Chlorine Dioxide is a commonly-used alternative to chlorine (Cl₂) as a water disinfectant. The Chlorophenol Red method (non-rapid method) reacts specifically with chlorine dioxide with little interference from free chlorine or chloramines, but the method procedure is cumbersome. The Chlorine Dioxide Rapid Method based on the DPD (N,N-diethyl-p-phenylenediamine) indicator is a much simpler method by comparison, but it is susceptible to interference from other oxidizers. Glycine (Reagent A) is able to convert free chlorine to chloroaminoacetic acid without affecting the analysis of chlorine dioxide content.

MEASUREMENT PROCEDURE

- Select the **Chlorine Dioxide (Rapid)** method using the procedure described in the Method Selection section.

- Fill the cuvette with 10 mL of unreacted sample (up to the mark).



- Add 5 drops of **HI96779A-0 Chlorine Dioxide Reagent A**.



- Replace the plastic stopper and the cap. Shake gently for 30 seconds.



- Wait 30 seconds.



- Insert the cuvette into the holder and close the lid.

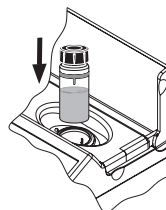

- Press **Zero**. The display will show “-0.0-” when the meter is zeroed and ready for measurement.

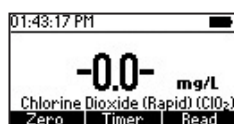
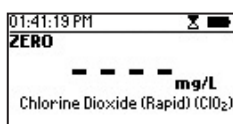
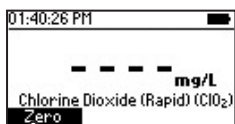

- Remove the cuvette.
- Add one packet of **HI96779B-0** Chlorine Dioxide Reagent B.
- Replace the plastic stopper and the cap. Shake gently for 20 seconds.
- Insert the cuvette into the holder and close the lid.

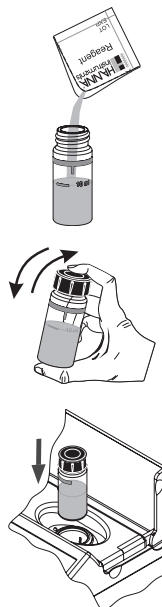

- Press **Timer** and the display will show the countdown prior to the measurement or wait 1 minute and press **Read**. When the timer ends the meter will perform the reading. The instrument displays the results in mg/L of ClO₂.

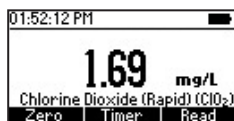
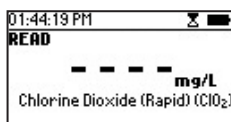
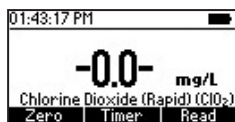

INTERFERENCES

Interference may be caused by:

- Acidity, Alkalinity, Flocculating agents, Hardness, Inorganic and Organic Chloramines, Manganese, Metals, Monochloramine, Oxidized forms of Chromium and Manganese, Ozone and Peroxides
- Chlorine above 5 mg/L
- Bromine above 0.1 mg/L
- Highly buffered samples or extreme sample pH

10.15. Chlorine, Free

SPECIFICATIONS

Range	0.00 to 5.00 mg/L (as Cl ₂)
Resolution	0.01 mg/L
Accuracy	±0.03 mg/L ± 3 % of reading at 25 °C
Light Source	LED with narrow band interference filter @ 525 nm
Method	Adaptation of the EPA DPD Method 330.5

REQUIRED REAGENTS

POWDER

Code	Description	Quantity
HI93701-0	Free Chlorine Reagent	1 packet

LIQUID

Code	Description	Quantity
HI93701A-F	Free Chlorine Reagent A	3 drops
HI93701B-F	Free Chlorine Reagent B	3 drops

REAGENT SETS

HI93701-F	Reagents for 300 tests (liquid)
HI93701-01	Reagents for 100 tests (powder)
HI93701-03	Reagents for 300 tests (powder)

For other accessories see the Accessories section.

MEASUREMENT PROCEDURE

- Select the **Chlorine (Free)** method using the procedure described in the Method Selection section.

- Fill the cuvette with 10 mL of unreacted sample (up to the mark).
Replace the plastic stopper and the cap.



- Insert the cuvette into the holder and close the lid.

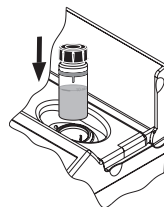

- Press **Zero**. The display will show “-0.0-” when the meter is zeroed and ready for measurement.

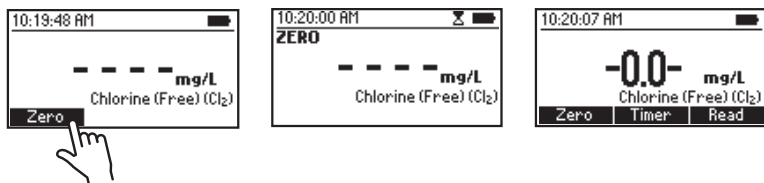

- Remove the cuvette.

POWDER REAGENT PROCEDURE

- Add the content of one packet of **HI93701-0** Free Chlorine Reagent. Replace the plastic stopper and the cap. Shake gently for 20 seconds.

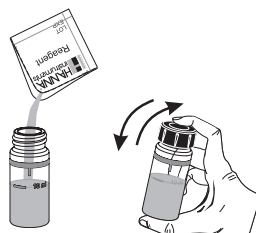

- Insert the cuvette into the holder and close the lid.

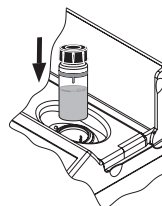

- Press **Timer** and the display will show the countdown prior to the measurement or wait 1 minute and press **Read**. When the timer ends the meter will perform the reading. The instrument displays the results in **mg/L** of chlorine (Cl_2).



LIQUID REAGENT PROCEDURE

- To an empty cuvette add 3 drops of HI93701A-F Free Chlorine Reagent A and 3 drops of HI93701B-F Free Chlorine Reagent B.

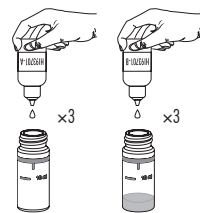

- Replace the plastic stopper and the cap. Swirl gently to mix.

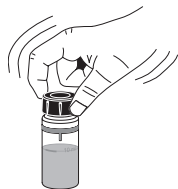

- Add 10 mL of unreacted sample (up to the mark). Replace the plastic stopper and the cap. Shake gently.



- Insert the cuvette into the holder and close the lid.

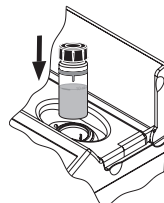

- Press **Read** to start the reading. The instrument displays the results in mg/L of chlorine (Cl_2).

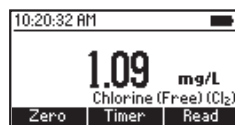
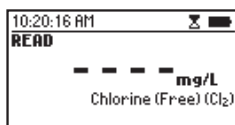
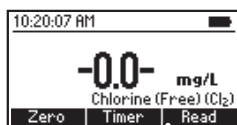

Note: Free and Total Chlorine have to be measured separately with fresh sample following the related procedure if both values are desired.

INTERFERENCES

Interference may be caused by:

- Bromine, Iodine, Oxidized forms of Chromium and Manganese, Ozone
- Hardness greater than 500 mg/L CaCO_3 , to remove the interference shake the sample for approximately 2 minutes after adding the powder reagent
- Alkalinity greater than 250 mg/L CaCO_3 or acidity value greater than 150 mg/L CaCO_3 , the color of the sample may develop only partially or rapidly fade, to remove the interference neutralize the sample with diluted HCl or NaOH

10.16. Chlorine, Free Ultra Low Range

SPECIFICATIONS

Range	0.000 to 0.500 mg/L (as Cl ₂)
Resolution	0.001 mg/L
Accuracy	±0.020 mg/L ± 3 % of reading at 25 °C
Light Source	LED with narrow band interference filter @ 525 nm
Method	Adaptation of the Standard Method 4500-Cl G

REQUIRED REAGENTS

Code	Description	Quantity
HI95762-0	Free Chlorine Ultra Low Range Reagent	1 packet

REAGENTS SETS

HI95762-01 Reagents for 100 tests

HI95762-03 Reagents for 300 tests

For other accessories see the Accessories section.

MEASUREMENT PROCEDURE

- Select the [Chlorine Free ULR](#) method using the procedure described in the Method Selection section.

- Fill the cuvette with 10 mL of unreacted sample (up to the mark).
Replace the plastic stopper and the cap.



10 mL

- Insert the cuvette into the holder and close the lid.

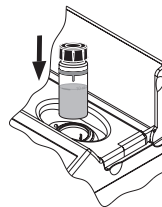

- Press **Zero**. The display will show “-0.0-” when the meter is zeroed and ready for measurement.

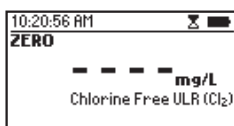
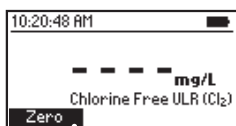

- Remove the cuvette.
- Add one packet of **H195762-0** Free Chlorine ULR Reagent. Replace the plastic stopper and the cap. Shake gently for 20 seconds.

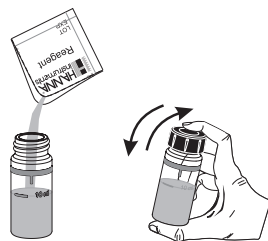

- Insert the cuvette into the holder and close the lid.

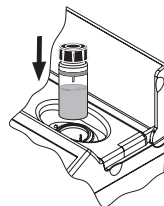

- Press **Timer** and the display will show the countdown prior to the measurement or wait 1 minute and press **Read**. When the timer ends the meter will perform the reading. The instrument displays the results in **mg/L of chlorine (Cl₂)**.

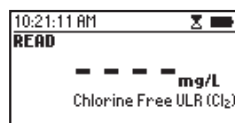

INTERFERENCES

Interference may be caused by:

- Bromine, Chlorine Dioxide, Iodine, Oxidized forms of Chromium and Manganese, Ozone
- Alkalinity greater than 1000 mg/L CaCO₃ if present as bicarbonate (pH < 8.3), above 25 mg/L CaCO₃ if present as carbonate (pH > 9.0) or acidity value greater than 150 mg/L CaCO₃, the color of the sample may develop only partially or rapidly fade, to remove the interference neutralize the sample with diluted HCl or NaOH
- Hardness greater than 500 mg/L CaCO₃, to remove the interference shake the sample for approximately 2 minutes after adding the powder reagent

10.17. Chlorine, Total

SPECIFICATIONS

Range	0.00 to 5.00 mg/L (as Cl ₂)
Resolution	0.01 mg/L
Accuracy	±0.03 mg/L ± 3 % of reading at 25 °C
Light Source	LED with narrow band interference filter @ 525 nm
Method	Adaptation of the EPA DPD Method 330.5

REQUIRED REAGENTS

POWDER

Code	Description	Quantity
HI93711-0	Total Chlorine Reagent	1 packet

LIQUID

Code	Description	Quantity
HI93701A-T	Total Chlorine Reagent A	3 drops
HI93701B-T	Total Chlorine Reagent B	3 drops
HI93701C-T	Total Chlorine Reagent C	1 drop

REAGENT SETS

HI93701-T	Reagents for 300 tests (liquid)
HI93711-01	Reagents for 100 total tests (powder)
HI93711-03	Reagents for 300 total tests (powder)

For other accessories see the Accessories section.

MEASUREMENT PROCEDURE

- Select the **Chlorine (Total)** method using the procedure described in the Method Selection section.

- Fill the cuvette with 10 mL of unreacted sample (up to the mark).
Replace the plastic stopper and the cap.



- Insert the cuvette into the holder and close the lid.

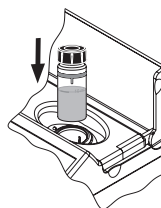

- Press **Zero**. The display will show “-0.0-” when the meter is zeroed and ready for measurement.

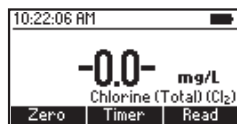
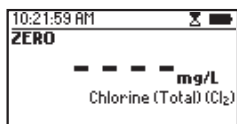
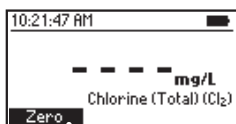

- Remove the cuvette.

POWDER REAGENT PROCEDURE

- Add 1 packet of **HI93711-0** Total Chlorine Reagent. Replace the plastic stopper and the cap. Shake gently for 20 seconds.

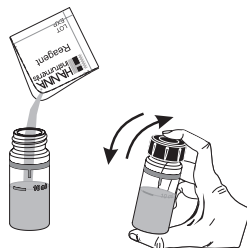

- Insert the cuvette into the holder and close the lid.

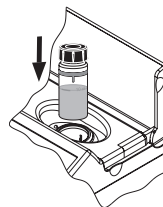

- Press **Timer** and the display will show the countdown prior to the measurement or wait 2 minutes and 30 seconds and press **Read**. When the timer ends the meter will perform the reading. The instrument displays the results in **mg/L** of chlorine (Cl_2).

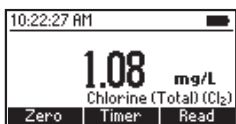
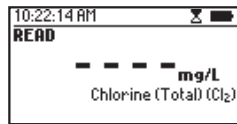
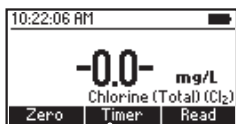

LIQUID REAGENT PROCEDURE

- To an empty cuvette add 3 drops of HI93701A-T Total Chlorine Reagent A, 3 drops of HI93701B-T Total Chlorine Reagent B and 1 drop of HI93701C-T Total Chlorine Reagent C.

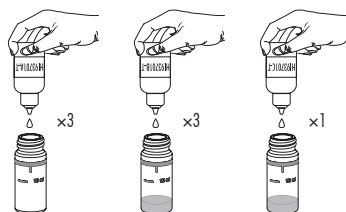

- Replace the plastic stopper and the cap. Swirl gently to mix.

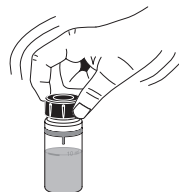

- Add 10 mL of unreacted sample (up to the mark). Replace the plastic stopper and the cap. Shake gently.



10 mL



- Insert the cuvette into the holder and close the lid.

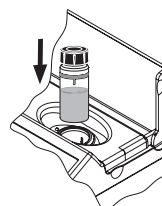

- Press **Timer** and the display will show the countdown prior to the measurement or wait 2 minutes and 30 seconds and press **Read**. When the timer ends the meter will perform the reading. The instrument displays the results in **mg/L of chlorine (Cl₂)**.

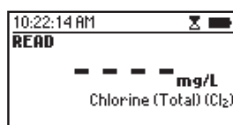
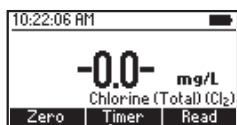

Note: Free and Total Chlorine have to be measured separately with fresh unreacted samples following the related procedure if both values are desired.

INTERFERENCES

Interference may be caused by:

- Bromine, Iodine, Oxidized forms of Chromium and Manganese, Ozone
- Hardness greater than 500 mg/L CaCO_3 , to remove the interference shake the sample for approximately 2 minutes after adding the powder reagent
- Alkalinity greater than 250 mg/L CaCO_3 or acidity greater than 150 mg/L CaCO_3 , the color of the sample may develop only partially or may rapidly fade, to remove the interference neutralize the sample with diluted HCl or NaOH

10.18. Chlorine, Total Ultra Low Range

SPECIFICATIONS

Range	0.000 to 0.500 mg/L (as Cl ₂)
Resolution	0.001 mg/L
Accuracy	±0.020 mg/L ± 3 % of reading at 25 °C
Light Source	LED with narrow band interference filter @ 525 nm
Method	Adaptation of the EPA Method 330.5

REQUIRED REAGENTS

Code	Description	Quantity
HI95761-0	Total Chlorine Ultra Low Range Reagent	1 packet

REAGENT SETS

HI95761-01 Reagents for 100 tests

HI95761-03 Reagents for 300 tests

For other accessories see the Accessories section.

MEASUREMENT PROCEDURE

- Select the **Chlorine (Total) ULR** method using the procedure described in the Method Selection section.

- Fill the cuvette with 10 mL of unreacted sample (up to the mark).
Replace the plastic stopper and the cap.



- Insert the cuvette into the holder and close the lid.

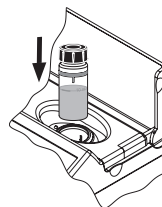

- Press **Zero**. The display will show “-0.0-” when the meter is zeroed and ready for measurement.

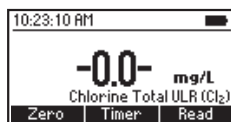
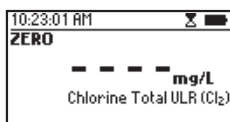
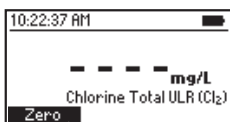

- Remove the cuvette.
- Add one packet of **H195761-0** Total Chlorine ULR Reagent. Replace the plastic stopper and the cap. Shake gently for 20 seconds.

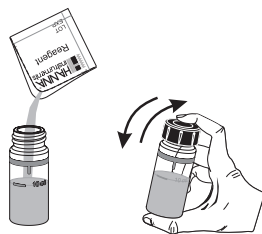

- Insert the cuvette into the holder and close the lid.

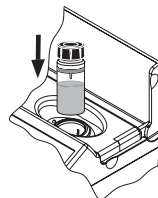

- Press **Timer** and the display will show the countdown prior to the measurement or wait 2 minutes and 30 seconds and press **Read**. When the timer ends the meter will perform the reading. The instrument displays the results in **mg/L of chlorine (Cl₂)**.

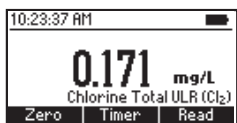
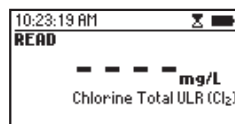
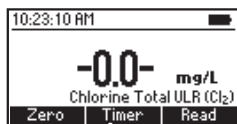

INTERFERENCES

Interference may be caused by:

- Bromine, Chlorine Dioxide, Iodine, Oxidized forms of Chromium and Manganese, Ozone
- Alkalinity greater than 1000 mg/L CaCO₃ if present as bicarbonate (pH < 8.3), above 25 mg/L CaCO₃ if present as carbonate (pH > 9.0) or acidity value greater than 150 mg/L CaCO₃, the color of the sample may develop only partially or rapidly fade, to remove the interference neutralize the sample with diluted HCl or NaOH
- Hardness greater than 500 mg/L CaCO₃, to remove the interference shake the sample for approximately 2 minutes after adding the powder reagent

10.19. Chlorine, Total Ultra High Range

SPECIFICATIONS

Range	0 to 500 mg/L (as Cl ₂)
Resolution	1 mg/L
Accuracy	± 3 mg/L ± 3 % of reading at 25 °C
Light Source	LED lamp with narrow band interference filter @ 525 nm
Method	Adaptation of Standard Methods for Examination of Water and Wastewater, 20 th Edition, 4500-Cl

REQUIRED REAGENTS

Code	Description	Quantity
HI95771A-0	Total Chlorine Ultra High Range Reagent A	1 packet
HI95771B-0	Total Chlorine Ultra High Range Reagent B	1 packet

REAGENTS SETS

HI95771-01 Reagents for 100 tests

HI95771-03 Reagents for 300 tests

For other accessories see the Accessories section.

MEASUREMENT PROCEDURE

- Select the **Chlorine (Total) UHR** method using the procedure described in the Method Selection section.
- Fill the cuvette with 10 mL of unreacted sample (up to the mark).
Replace the plastic stopper and the cap.



- Insert the cuvette into the holder and close the lid.

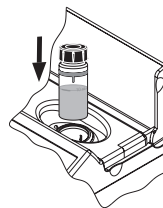

- Press **Zero**. The display will show “-0.0-” when the meter is zeroed and ready for measurement.

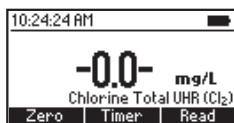
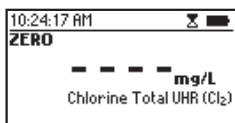
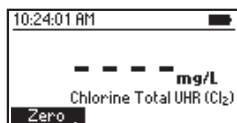

- Remove the cuvette.
- Add one packet of **HI95771A-0** Total Chlorine Ultra High Range Reagent A and one packet **HI95771B-0** Total Chlorine Ultra High Range Reagent B. Replace the plastic stopper and the cap. Shake gently for 20 seconds.

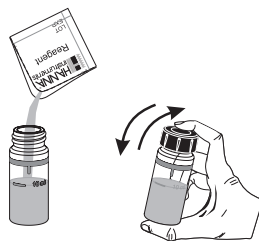

- Insert the cuvette into the holder and close the lid.

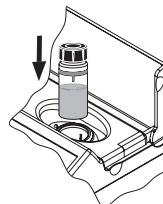

- Press **Timer** and the display will show the countdown prior to the measurement or wait 1 minute and press **Read**. When the timer ends the meter will perform the reading. The instrument displays the results in **mg/L** of chlorine (Cl_2).

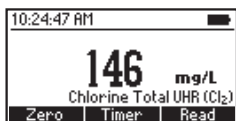
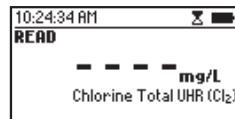
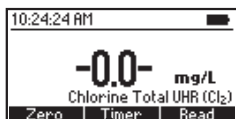

INTERFERENCES

Interference may be caused by:

- Bromine, Chlorine Dioxide, Chromium, Iodine, Oxidized Manganese, Ozone

10.20. Chromium(VI) Low Range

SPECIFICATIONS

Range	0 to 300 $\mu\text{g/L}$ (as Cr (VI))
Resolution	1 $\mu\text{g/L}$
Accuracy	$\pm 10 \mu\text{g/L} \pm 4\%$ of reading at 25 °C
Light Source	LED with narrow band interference filter @ 525 nm
Method	Adaptation of the ASTM Manual of Water and Environmental Technology, D1687 Diphenylcarbohydrazide Method

REQUIRED REAGENTS

Code	Description	Quantity
HI93749-0	Chromium(VI) Low Range Reagent	1 packet

REAGENT SETS

HI93749-01 Reagents for 100 tests

HI93749-03 Reagents for 300 tests

For other accessories see the Accessories section.

MEASUREMENT PROCEDURE

- Select the **Chromium(VI) LR** method using the procedure described in the Method Selection section.

- Fill the cuvette with 10 mL of unreacted sample (up to the mark).
Replace the plastic stopper and the cap.



- Insert the cuvette into the holder and close the lid.

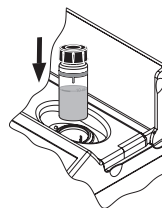

- Press **Zero**. The display will show “-0.0-” when the meter is zeroed and ready for measurement.

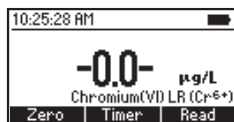
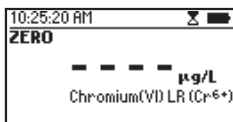
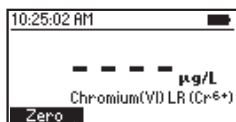

- Remove the cuvette.
- Add one packet of **HI93749-0** Chromium(VI) Low Range Reagent. Replace the plastic stopper and the cap. Shake vigorously for about 10 seconds.
- Insert the cuvette into the holder and close the lid.

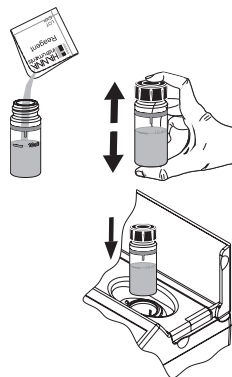

- Press **Timer** and the display will show the countdown prior to the measurement or wait 6 minutes and press **Read**. When the timer ends the meter will perform the reading. The instrument displays concentration in $\mu\text{g/L}$ of chromium (Cr^{6+}).

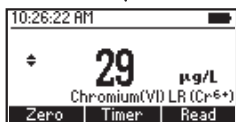
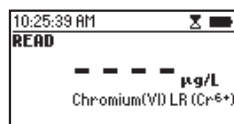
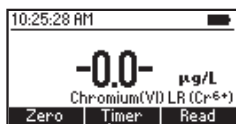

- Press the **▲** or **▼** key to access the second level functions.
- Press **Chem Frm** to convert the result to $\mu\text{g/L}$ of chromate (CrO_4^{2-}) and dichromate ($\text{Cr}_2\text{O}_7^{2-}$).

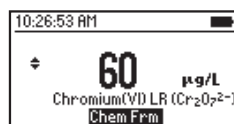
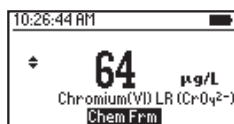
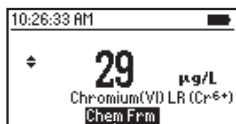

- Press the **▲** or **▼** key to return to the measurement screen.

INTERFERENCES

Interference may be caused by:

- Vanadium above 1 mg/L, wait 10 minutes before reading to remove the interference
- Iron above 1 mg/L
- Mercurous and mercuric ions slight inhibition of the reaction

10.21. Chromium(VI) High Range

SPECIFICATIONS

Range	0 to 1000 $\mu\text{g/L}$ (as Cr(VI))
Resolution	1 $\mu\text{g/L}$
Accuracy	$\pm 5 \mu\text{g/L} \pm 4\%$ of reading at 25 °C
Light Source	LED with narrow band interference filter @ 525 nm
Method	Adaptation of the ASTM Manual of Water and Environmental Technology, D1687-92, Diphenylcarbohydrazide Method

REQUIRED REAGENTS

Code	Description	Quantity
HI93723-0	Chromium(VI) High Range Reagent	1 packet

REAGENT SETS

HI93723-01 Reagents for 100 tests

HI93723-03 Reagents for 300 tests

For other accessories see the Accessories section.

MEASUREMENT PROCEDURE

- Select the **Chromium(VI) HR** method using the procedure described in the Method Selection section.

- Fill the cuvette with 10 mL of unreacted sample (up to the mark).
Replace the plastic stopper and the cap.



- Insert the cuvette into the holder and close the lid.

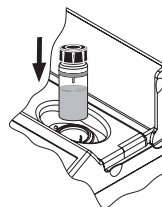

- Press **Zero**. The display will show “-0.0-” when the meter is zeroed and ready for measurement.

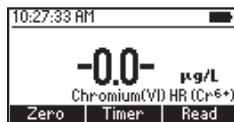
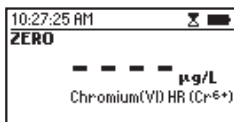
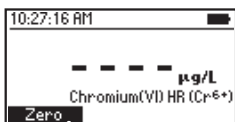

- Remove the cuvette.
- Add one packet of **HI93723-0** Chromium(VI) High Range Reagent. Replace the plastic stopper and the cap. Shake vigorously for about 10 seconds.
- Insert the cuvette into the holder and close the lid.

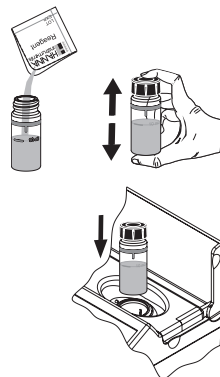

- Press **Timer** and the display will show the countdown prior to the measurement or wait 6 minutes and press **Read**. When the timer ends the meter will perform the reading. The instrument displays concentration in $\mu\text{g/L}$ of **chromium (Cr^{6+})**.

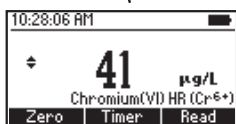
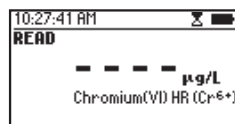
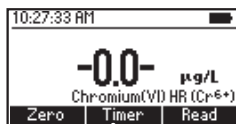

- Press the \blacktriangle or \blacktriangledown key to access the second level functions.
- Press **Chem Frm** to convert the result to $\mu\text{g/L}$ of **chromate (CrO_4^{2-})** and **dichromate ($\text{Cr}_2\text{O}_7^{2-}$)**.

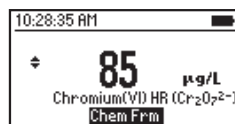
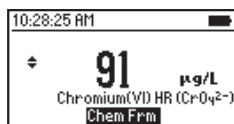
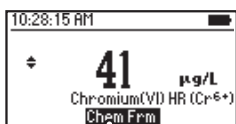

- Press the \blacktriangle or \blacktriangledown key to return to the measurement screen.

INTERFERENCES

Interference may be caused by:

- Vanadium above 1 mg/L, wait 10 minutes before reading to remove the interference
- Iron above 1 mg/L
- Mercurous and mercuric ions slight inhibition of the reaction

10.22. Chromium(VI)/Total (16 mm Vial)

SPECIFICATIONS

Range	0 to 1000 $\mu\text{g/L}$ (as Cr)
Resolution	1 $\mu\text{g/L}$
Accuracy	$\pm 10 \mu\text{g/L} \pm 3\%$ of reading
Light Source	LED with narrow band interference filter @ 525 nm
Method	Adaptation of the Standard Methods of the Examination of Water and Wastewater, 22 nd Edition, 3500-Cr, Diphenylcarbazide method

REQUIRED REAGENTS

Code	Description	Quantity
HI96781V-0*	Chromium Digestion Vial	1 vial
HI96781A-0	Chromium Reagent A	1 packet
HI96781B-0	Chromium Reagent B	1 packet

*Reagent vial identification: Cr, red label

REAGENTS SETS

HI96781-25 Reagent for 25 tests

For other accessories see the Accessories section.

Note: Store the unused vials in their packaging in a cool and dark place.

PRINCIPLE

The chromium in the sample is oxidized to hexavalent chromium during digestion. The hexavalent chromium reacts with the Diphenylcarbazide to form a red color proportional to the amount of chromium in the sample. This method has a strong temperature and pH dependence. The sample temperature must be between 18 and 22 °C (64 and 72 °F) and the pH between 3 and 9.

APPLICATION

Water, wastewater, process control

SIGNIFICANCE & USE

Chromium(III) is an essential element for humans and can be metabolized in the body. Chromium(III) is found naturally in fruit, vegetables, meat and grains. Chromium(VI) has been identified as a carcinogen and can alter genetic material. Chromium(VI) is discharged from steel and paper mills or through the oxidation of chromium(III). Chromium(VI) has been a regulated drinking water contaminate since the 1940s, the US EPA only regulates total chromium.

MEASUREMENT PROCEDURE

CHROMIUM TOTAL



Before using the reagent kit carefully read all the instructions and the Safety Data Sheets (SDS). Pay particular attention to all warnings, cautions and notes. Failure to do so may result in serious injury to the operator.

The acidification of the sample may result in the release of toxic gas, such as cyanides and sulfides. Sample preparation and digestion should be done in a fume hood.

- Preheat the Hanna[®] Reactor [HI839800](#) to 105 °C (221 °F). The optional [HI740217](#) safety shield is strongly recommended.

Warning: Do not use an oven or microwave! Samples may leak and generate a corrosive and possibly explosive atmosphere.

- Remove the cap from a [HI96781V-0](#) Chromium Digestion Vial.



- Add 5 mL of sample to the vial, while keeping the vial at a 45-degree angle.



- Add one packet of [HI96781A-0](#) Chromium Reagent A to the vial. Replace the cap and invert for 30 seconds.

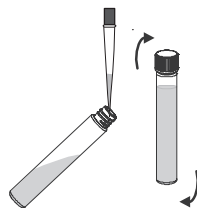

- Insert the vial into the reactor and heat it for 60 minutes at 105 °C (221 °F).



- At the end of the digestion period switch off the reactor. Allow the vials to cool to room temperature. Invert each vial several times and place them in the test tube rack.



- Select the **Chromium(VI)/Total(16)** method using the procedure described in the Method Selection section.
- Insert the 16 mm vial adapter using the procedure described in the Using the 16 mm Vial Adapter section.
- Place the vial into the holder.

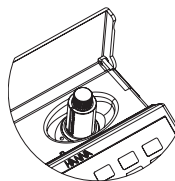

- Press **Zero**. The display will show "-0.0-" when the meter is zeroed and ready for measurement.

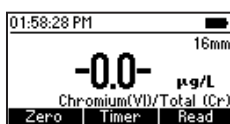
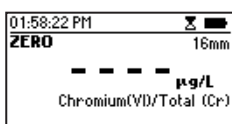
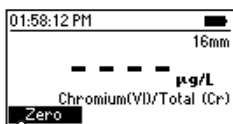

- Remove the vial.
- Add one packet of **HI96781B-0** Chromium Reagent B. Replace the cap and shake vigorously for 1 minute.

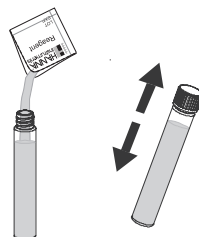

- Place the vial into the holder.

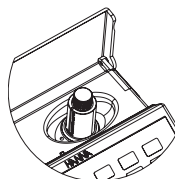

- Press **Timer** and the display will show the countdown prior to the measurement or wait 6 minutes and press **Read**. The instrument displays the result in $\mu\text{g/L}$ of chromium (Cr).

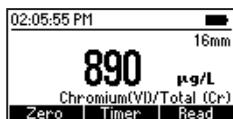
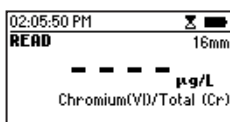
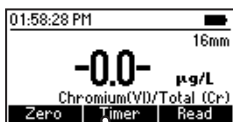

CHROMIUM(VI)

- Remove the cap from a [HI96781V-0](#) Chromium Digestion Vial.



- Add 5 mL of sample to the vial, while keeping the vial at a 45-degree angle. Replace the cap and invert several times to mix.



- Select the [Chromium\(VI\)/Total\(16\)](#) method using the procedure described in the Method Selection section.

- Insert the 16 mm vial adapter using the procedure described in the Using the 16 mm Vial Adapter section.

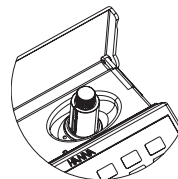

- Place the vial into the holder.

- Press **Zero**. The display will show "-0.0-" when the meter is zeroed and ready for measurement.

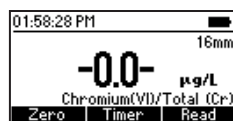
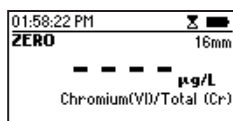
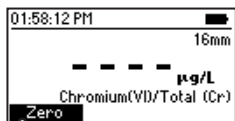

- Remove the cap and add one packet of [HI96781B-0](#) Chromium Reagent B. Replace the cap and shake vigorously for 1 minute.

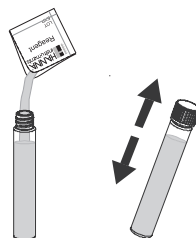

- Place the vial into the holder.

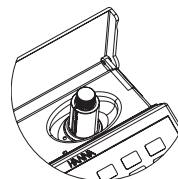

- Press **Timer** and the display will show the countdown prior to the measurement or wait 6 minutes and press **Read**. The instrument displays the result in $\mu\text{g/L}$ of chromium (Cr).

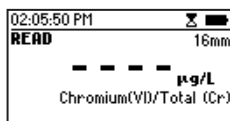
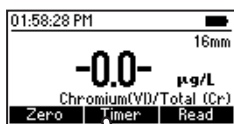

- To determine the Chromium(III) concentration, subtract the results from the Chromium(VI) procedure from the Chromium Total procedure.

INTERFERENCES

Interference may be caused by:

- Large amounts of iron, copper or reducing and oxidizing agents yield falsely low readings
- Nitrate, Potassium, Sulfate above 2000 mg/L
- Chloride, Sodium above 1000 mg/L
- Calcium above 125 mg/L
- Ammonium, Magnesium above 100 mg/L
- Nickel, Zinc above 25 mg/L
- Copper, Iron above 10 mg/L

10.23. Chemical Oxygen Demand Low Range (16 mm Vial)

SPECIFICATIONS

Range	0 to 150 mg/L (as O ₂)
Resolution	1 mg/L
Accuracy	± 5 mg/L or ± 4 % of reading at 25 °C, whichever is greater
Light Source	LED with narrow band interference filter @ 420 nm
Method	Adaptation of the US EPA 410.4 Approved Method for the COD Determination on Surface Waters and Wastewaters

REQUIRED REAGENTS

EPA REAGENT

Code	Description	Quantity
HI93754A-0*	COD Low Range EPA Reagent Vial	2 vials
DEIONIZED120	Deionized Water	2 mL

MERCURY FREE REAGENT

Code	Description	Quantity
HI93754D-0*	COD Low Range Hg Free Reagent Vial	2 vials
DEIONIZED120	Deionized Water	2 mL

ISO REAGENT

Code	Description	Quantity
HI93754F-0*	COD Low Range ISO Reagent Vial	2 vials
DEIONIZED120	Deionized Water	2 mL

* Reagent vial identification: COD A, COD D, COD F, red label

REAGENT SETS

HI93754A-25	Reagents EPA Low Range for 24 tests
HI93754D-25	Reagents Hg Free Low Range for 24 tests
HI93754F-25	Reagents ISO Low Range for 24 tests

For other accessories see the Accessories section.

Note: Store the unused vials in their packaging in a cool and dark place.

MEASUREMENT PROCEDURE



Before using the reagent kit carefully read all the instructions and the Safety Data Sheets (SDS). Pay particular attention to all warnings, cautions and notes. Failure to do so may result in serious injury to the operator.

Reagent Blank Correction: This method requires a reagent blank correction. A single blank vial may be used more than once. The blank vial is stable for several months at room temperature. For improved accuracy, run a blank for each set of measurements and always use the same lot of reagents for blank and samples.

- Choose a homogeneous sample. Samples containing solids capable of settling need to be homogenized with a blender.
- Preheat the Hanna® Reactor [HI839800](#) to 150 °C (302 °F). The optional [HI740217](#) safety shield is strongly recommended. Do not use an oven or microwave; samples may leak and generate a corrosive and possibly explosive atmosphere.
- Remove the cap from two COD Low Range Reagent Vials.



- Add 2 mL of deionized water to the first vial (#1) and 2 mL of sample to the second vial (#2), while keeping the vials at a 45-degree angle. Replace the caps and invert several times to mix.

Warning: The vials will become hot during mixing, use caution when handling.

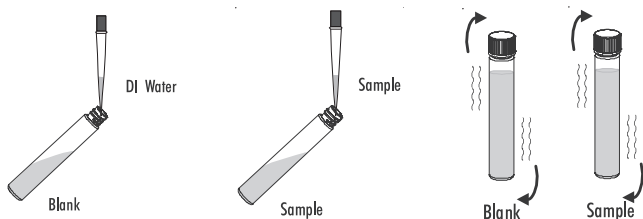

- Insert the vials into the reactor and heat them for 2 hours at 150 °C (302 °F).
- At the end of the digestion period switch off the reactor. Wait 20 minutes to allow the vials to cool to about 120 °C (248 °F).
- Invert each vial several times while still warm, then place them in the test tube rack.

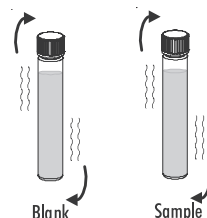

Warning: The vials are still hot, use caution when handling.

- Leave the vials in the tube rack to cool to room temperature. Do not shake or invert them, the samples may become turbid.

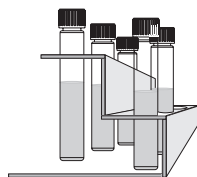

- Select **COD LR (16)** method using the procedure described in the Method Selection section.

- Insert the 16 mm vial adapter using the procedure described in the Using the 16 mm Vial Adapter section.

- Insert the blank vial (#1) into the holder.

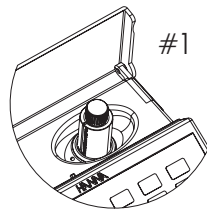

- Press **Zero**. The display will show -0.0- when the meter is zeroed and ready for measurement.

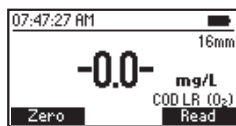
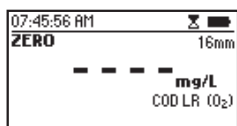
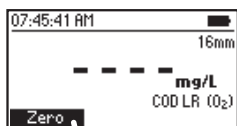

- Remove the vial.
- Insert the sample vial (#2) into the holder.

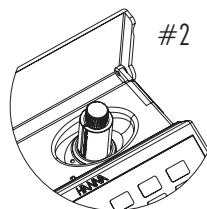

- Press **Read** to start the reading. The instrument displays the results in mg/L of oxygen (O₂).

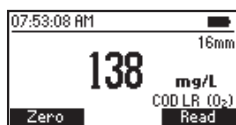
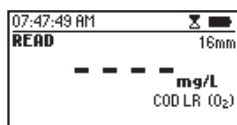
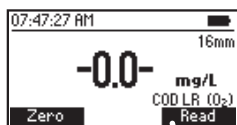

INTERFERENCES

Interference may be caused by:

- Chloride above 2000 mg/L, samples with higher chloride concentration should be diluted

10.24. Chemical Oxygen Demand Medium Range (16 mm Vial)

SPECIFICATIONS

Range	0 to 1500 mg/L (as O ₂)
Resolution	1 mg/L
Accuracy	± 15 mg/L or ± 4 % of reading at 25 °C, whichever is greater
Light Source	LED with narrow band interference filter @ 610 nm
Method	Adaptation of the US EPA 410.4 Approved Method for the COD Determination on Surface Waters and Wastewaters

Note: Range is reduced to 1000 mg/L (as O₂) when HI93754G-25 reagents are used.

REQUIRED REAGENTS

EPA REAGENT

Code	Description	Quantity
HI93754B-0*	COD Medium Range EPA Reagent Vial	2 vials
DEIONIZED120	Deionized Water	2 mL

MERCURY FREE REAGENT

Code	Description	Quantity
HI93754E-0*	COD Medium Range Hg Free Reagent Vial	2 vials
DEIONIZED120	Deionized Water	2 mL

ISO REAGENT

Code	Description	Quantity
HI93754G-0*	COD Medium Range ISO Reagent Vial	2 vials
DEIONIZED120	Deionized Water	2 mL

* Reagent vial identification: COD B, COD E, COD G, white label

REAGENT SETS

HI93754B-25	Reagents EPA Medium Range for 24 tests
HI93754E-25	Reagents Hg Free Medium Range for 24 tests
HI93754G-25	Reagents ISO Medium Range for 24 tests

For other accessories see the Accessories section.

Note: Store the unused vials in their packaging in a cool and dark place.

MEASUREMENT PROCEDURE



Before using the reagent kit carefully read all the instructions and the Safety Data Sheets (SDS). Pay particular attention to all warnings, cautions and notes. Failure to do so may result in serious injury to the operator.

Reagent Blank Correction: This method requires a reagent blank correction. A single blank vial may be used more than once. The blank vial is stable for several months at room temperature. For improved accuracy measurement, run a blank for each set of measurements and always use the same lot of reagents for blank and samples.

- Choose a homogeneous sample. Samples containing solids capable of settling need to be homogenized with a blender.
- Preheat the Hanna® Reactor HI839800 to 150 °C (302 °F). Use of the optional HI740217 safety shield is strongly recommended. Do not use an oven or microwave; samples may leak and generate a corrosive and possibly explosive atmosphere.
- Remove the cap from two COD Medium Range Reagent Vials.



- Add 2 mL of deionized water to the first vial (#1) and 2 mL of sample to the second vial (#2), while keeping the vials at a 45-degree angle. Replace the caps and invert several times to mix.

Warning: The vials will become hot during mixing, use caution when handling.

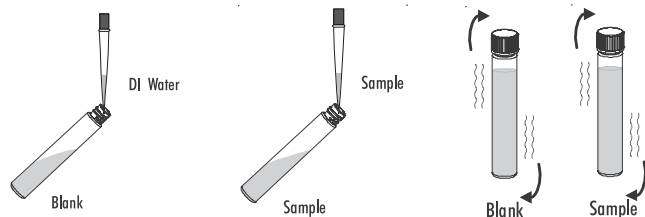

- Insert the vials into the reactor and heat them for 2 hours at 150 °C (302 °F).
- At the end of the digestion period switch off the reactor. Wait 20 minutes to allow the vials to cool to about 120 °C (248 °F).



- Invert each vial several times while still warm, then place them in the test tube rack.

Warning: The vials are still hot, use caution when handling.

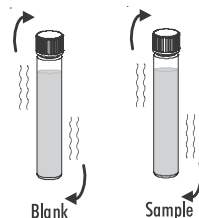

- Leave the vials in the tube rack to cool to room temperature. Do not shake or invert them, the samples may become turbid.



- Select **COD MR (16)** method using the procedure described in the Method Selection section.

- Insert the 16 mm vial adapter using the procedure described in the Using the 16 mm Vial Adapter section.
- Insert the blank vial into the holder.

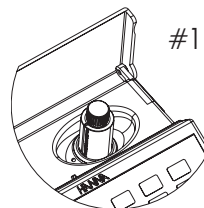

- Press **Zero**. The display will show -0.0- when the meter is zeroed and ready for measurement.

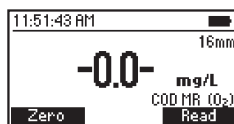
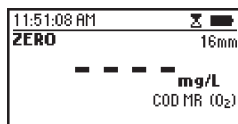
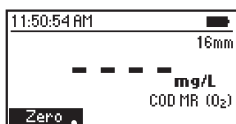

- Remove the vial.
- Insert the sample vial (#2) into the holder.

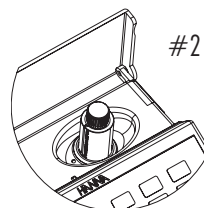

- Press **Read** to start the reading. The instrument displays the results in mg/L of oxygen (O₂).

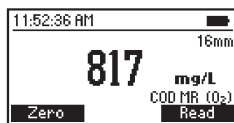
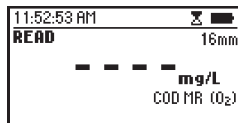

INTERFERENCES

Interference may be caused by:

- Chloride above 2000 mg/L, samples with higher chloride concentration should be diluted

10.25. Chemical Oxygen Demand High Range (16 mm Vial)

SPECIFICATIONS

Range	0 to 15000 mg/L (as O ₂)
Resolution	1 mg/L
Accuracy	± 150 mg/L or ± 2 % of reading at 25 °C, whichever is greater
Light Source	LED with narrow band interference filter @ 610 nm
Method	Adaptation of the US EPA 410.4 Approved Method for the COD Determination on Surface Waters and Wastewaters

REQUIRED REAGENTS

Code	Description	Quantity
HI93754C-0*	COD High Range Reagent Vial	2 vials
DEIONIZED120	Deionized Water	0.2 mL

* Reagent vial identification: COD C, green label

REAGENT SETS

HI93754C-25 Reagents COD High Range for 24 tests

For other accessories see the Accessories section.

Note: Store the unused vials in their packaging in a cool and dark place.

MEASUREMENT PROCEDURE



Before using the reagent kit carefully read all the instructions and the Safety Data Sheets (SDS). Pay particular attention to all warnings, cautions and notes. Failure to do so may result in serious injury to the operator.

Reagent Blank Correction: This method requires a reagent blank correction. A single blank vial may be used more than once. The blank vial is stable for several months at room temperature. For improved accuracy measurement, run a blank for each set of measurements and always use the same lot of reagents for blank and samples.

- Choose a homogeneous sample. Samples containing solids capable of settling need to be homogenized with a blender.
- Preheat the Hanna[®] Reactor HI839800 to 150 °C (302 °F). Use of the optional HI740217 safety shield is strongly recommended. Do not use an oven or microwave, samples may leak and generate a corrosive and possibly explosive atmosphere.
- Remove the cap from two COD High Range Reagent Vials.

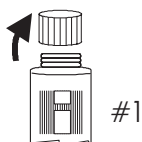

- Add 0.2 mL of deionized water to the first vial (#1) and 0.2 mL of sample to the second vial (#2), while keeping the vials at a 45-degree angle. Replace the caps and invert several times to mix.

Warning: The vials will become hot during mixing, use caution when handling.

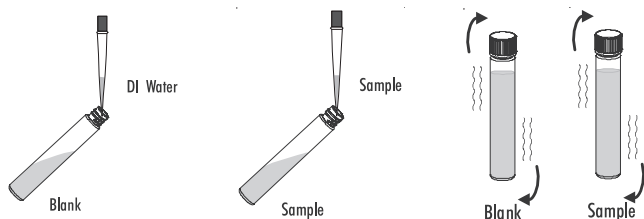

- Insert the vials into the reactor and heat them for 2 hours at 150 °C (302 °F).
- At the end of the digestion period switch off the reactor. Wait 20 minutes to allow the vials to cool to about 120 °C (248 °F).



- Invert each vial several times while still warm, then place them in the test tube rack.

Warning: The vials are still hot, use caution when handling.

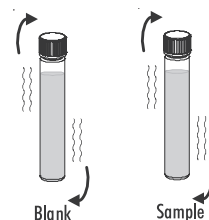

- Leave the vials in the tube rack to cool to room temperature. Do not shake or invert them, the samples may become turbid.
- Select [COD HR \(16\)](#) method using the procedure described in the Method Selection section.



- Insert the 16 mm vial adapter using the procedure described in the Using the 16 mm Vial Adapter section.
- Insert the blank vial (#1) into the holder.

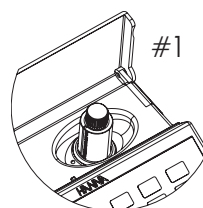

- Press **Zero**. The display will show -0.0- when the meter is zeroed and ready for measurement.

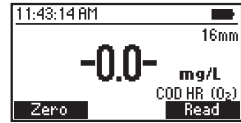
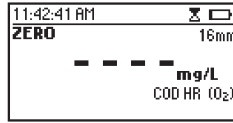
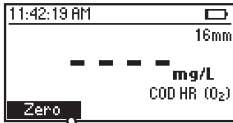

- Remove the vial.
- Insert the sample vial (#2) into the holder.

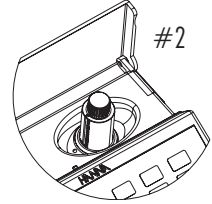

- Press **Read** to start the reading. The instrument displays the results in mg/L of oxygen (O₂).

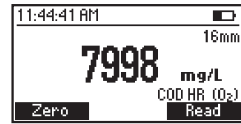
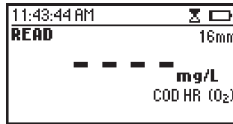
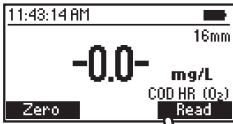

INTERFERENCES

Interference may be caused by:

- Chloride above 20000 mg/L, samples with higher chloride concentration should be diluted

10.26. Chemical Oxygen Demand, Ultra High Range (16 mm Vial)

SPECIFICATIONS

Range	0 to 60.0 g/L (as O ₂)
Resolution	0.1 g/L
Accuracy	± 0.5 g/L ± 3 % of reading at 25 °C
Light Source	LED with narrow band interference filter @ 610 nm
Method	Adaptation of the US EPA 410.4 Approved Method for the COD Determination on Surface Waters and Wastewaters

REQUIRED REAGENTS

Code	Description	Quantity
HI93754J-0*	COD Ultra High Range Reagent Vial	2 vials
DEIONIZED120	Deionized Water	0.1 mL

* Reagent vial identification: COD J, blue label

REAGENT SETS

HI93754J-25 Reagents COD Ultra High Range for 24 tests

For other accessories see the Accessories section.

Note: Store the unused vials in their packaging in a cool and dark place.

MEASUREMENT PROCEDURE



Before using the reagent kit carefully read all the instructions and the Safety Data Sheets (SDS). Pay particular attention to all warnings, cautions and notes. Failure to do so may result in serious injury to the operator.

Reagent Blank Correction: This method requires a reagent blank correction. A single blank vial may be used more than once. The blank vial is stable for several months at room temperature. For improved accuracy measurement, run a blank for each set of measurements and always use the same lot of reagents for blank and samples.

- Choose a homogeneous sample. Samples containing solids capable of settling need to be homogenized with a blender.
- Preheat the Hanna[®] Reactor HI839800 to 150 °C (302 °F). Use of the optional HI740217 safety shield is strongly recommended. Do not use an oven or microwave, samples may leak and generate a corrosive and possibly explosive atmosphere.
- Remove the cap from two COD Ultra High Range Reagent Vials.



- Add 0.1 mL of deionized water to the first vial (#1) and 0.1 mL of sample to the second vial (#2), while keeping the vials at a 45-degree angle. Replace the caps and invert several times to mix.

Warning: The vials will become hot during mixing, use caution when handling.

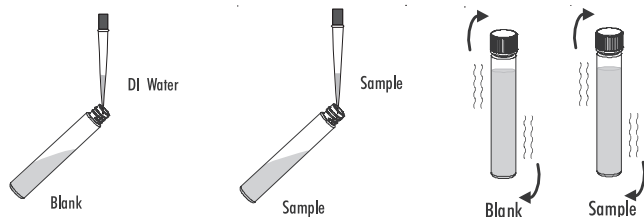

- Insert the vials into the reactor and heat them for 2 hours at 150 °C (302 °F).
- At the end of the digestion period, switch off the reactor. Wait 20 minutes to allow the vials to cool to about 120 °C (248 °F).



- Invert each vial several times while still warm, then place them in the test tube rack.

Warning: The vials are still hot, use caution when handling.

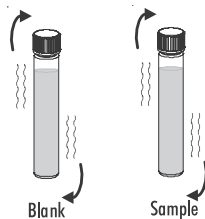

- Leave the vials in the tube rack to cool to room temperature. Do not shake or invert them, the samples may become turbid.
- Select **COD UHR (16)** method using the procedure described in the Method Selection section.



- Insert the 16 mm vial adapter using the procedure described in the Using the 16 mm Vial Adapter section.
- Insert the blank vial (#1) into the holder.

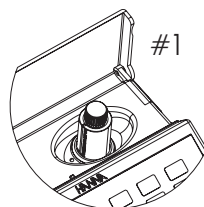

- Press **Zero**. The display will show -0.0- when the meter is zeroed and ready for measurement.

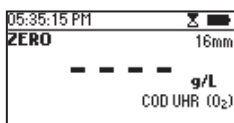
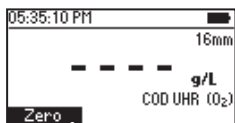

- Remove the vial.
- Insert the sample vial (#2) into the holder.

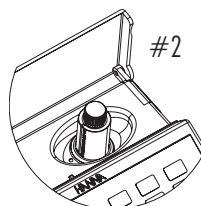

- Press **Read** to start the reading. The instrument displays the results in g/L of oxygen (O₂).

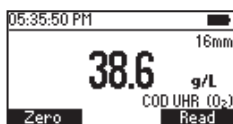
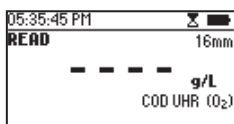

INTERFERENCES

Interference may be caused by:

- Chloride above 20000 mg/L, samples with higher chloride concentration should be diluted

10.27. Color of Water

SPECIFICATIONS

Range	0 to 500 PCU (Platinum Cobalt Units)
Resolution	1 PCU
Accuracy	± 10 PCU $\pm 5\%$ of reading at 25 °C
Light Source	LED with narrow band interference filter @ 420 nm
Method	Adaptation of Standard Methods for the Examination of Water and Wastewater, 18 th Edition, Colorimetric Platinum Cobalt Method

REQUIRED ACCESSORIES

0.45 μ m membrane for true color measurement
 For other accessories see the Accessories section.

MEASUREMENT PROCEDURE

- Select the **Color of Water** method using the procedure described in the Method Selection section.

- Fill the first cuvette (#1) with 10 mL of deionized water (up to the mark). Replace the plastic stopper and the cap. This is the blank.



- Insert the blank (#1) into the holder and close the lid.

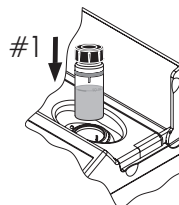

- Press **Zero**. The display will show “-0.0-” when the meter is zeroed and ready for measurement.

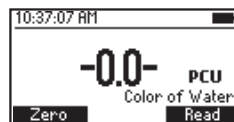
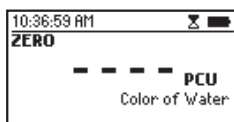
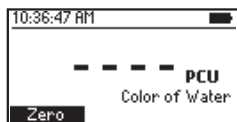

- Remove the cuvette
- Fill the second cuvette (#2) with 10 mL of unfiltered sample (up to the mark). Replace the plastic stopper and the cap. This is the apparent color.



- Filter 10 mL of sample through a filter with a $0.45\ \mu\text{m}$ membrane into the third cuvette (#3), up to the 10 mL mark. Replace the plastic stopper and the cap. This is the true color.



- Insert the apparent color cuvette (#2) into the holder and close the lid.

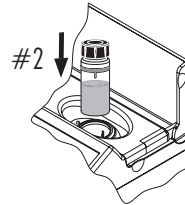

- Press **Read** to start the reading. The meter displays the value of apparent color in **Platinum Cobalt Units (PCU)**.

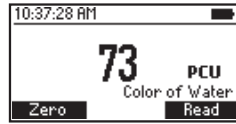
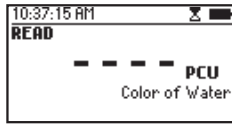
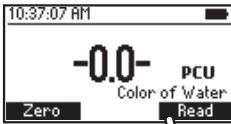

- Remove the apparent color cuvette (#2) from the holder, insert the true color cuvette (#3) into the holder and close the lid.

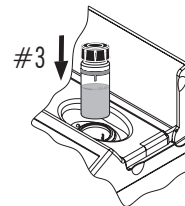

- Press **Read** to start the reading. The meter displays the true color in **Platinum Cobalt Units (PCU)**.

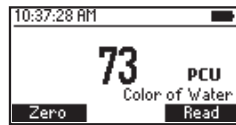
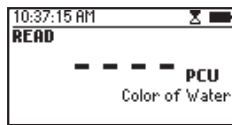

10.28. Copper Low Range

SPECIFICATIONS

Range	0.000 to 1.500 mg/L (as Cu ²⁺)
Resolution	0.001 mg/L
Accuracy	±0.010 mg/L ± 5 % of reading at 25 °C
Light Source	LED with narrow band interference filter @ 575 nm
Method	Adaptation of the EPA Method

REQUIRED REAGENTS

Code	Description	Quantity
HI95747-0	Copper Low Range Reagent	1 packet

REAGENT SETS

HI95747-01 Reagents for 100 tests

HI95747-03 Reagents for 300 tests

For other accessories see the Accessories section.

MEASUREMENT PROCEDURE

- Select the **Copper LR** method using the procedure described in the Method Selection section.

- Fill the cuvette with 10 mL of unreacted sample (up to the mark).
Replace the plastic stopper and the cap.



- Insert the cuvette into the holder and close the lid.

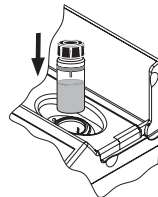

- Press **Zero**. The display will show “-0.0-” when the meter is zeroed and ready for measurement.

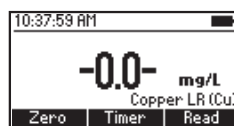
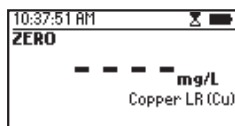
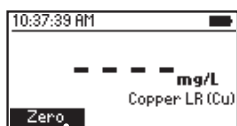

- Remove the cuvette.
- Add one packet of **HI95747-0** Copper Low Range Reagent. Replace the plastic stopper and the cap. Shake gently for about 15 seconds.
- Insert the cuvette into the holder and close the lid.

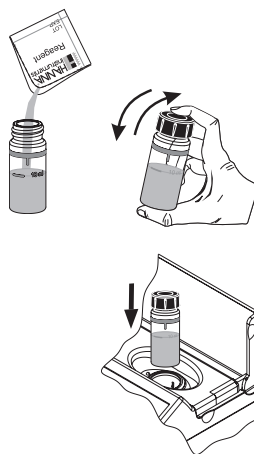

- Press **Timer** and the display will show the countdown prior to the measurement or wait 45 seconds and press **Read**. When the timer ends the meter will perform the reading. The instrument displays the results in **mg/L of copper (Cu)**.

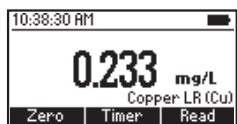
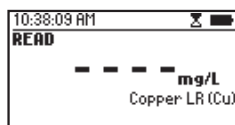
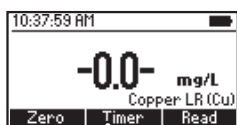

INTERFERENCES

Interference may be caused by:

- Cyanide, Silver
- For samples overcoming buffering capacity of reagent around pH 6.8, pH should be adjusted between 6 and 8

10.29. Copper High Range

SPECIFICATIONS

Range	0.00 to 5.00 mg/L (as Cu ²⁺)
Resolution	0.01 mg/L
Accuracy	±0.02 mg/L ± 4 % of reading at 25 °C
Light Source	LED with narrow band interference filter @ 575 nm
Method	Adaptation of the EPA Method

REQUIRED REAGENTS

Code	Description	Quantity
HI93702-0	Copper High Range Reagent	1 packet

REAGENT SETS

HI93702-01 Reagents for 100 tests

HI93702-03 Reagents for 300 tests

For other accessories see the Accessories section.

MEASUREMENT PROCEDURE

- Select the **Copper HR** method using the procedure described in the Method Selection section.

- Fill the cuvette with 10 mL of unreacted sample (up to the mark).
Replace the plastic stopper and the cap.



- Insert the cuvette into the holder and close the lid.

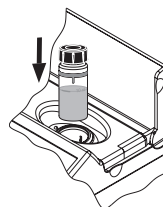

- Press **Zero**. The display will show “-0.0-” when the meter is zeroed and ready for measurement.

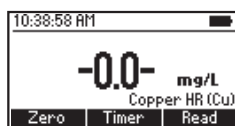
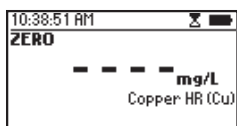
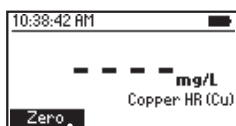

- Remove the cuvette.
- Add one packet of **HI93702-0** Copper High Range Reagent. Replace the plastic stopper and the cap. Shake gently for about 15 seconds.
- Insert the cuvette into the holder and close the lid.

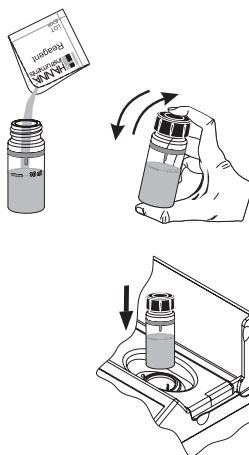

- Press **Timer** and the display will show the countdown prior to the measurement or wait 45 seconds and press **Read**. When the timer ends the meter will perform the reading. The instrument displays the results in **mg/L of copper (Cu)**.

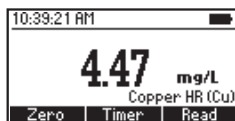
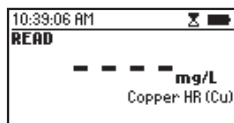
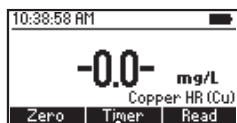

INTERFERENCES

Interference may be caused by:

- Cyanide, Silver
- For samples overcoming buffering capacity of reagent around pH 6.8, pH should be adjusted between 6 and 8

10.30. Cyanuric Acid

SPECIFICATIONS

Range	0 to 80 mg/L (as CYA)
Resolution	1 mg/L
Accuracy	± 1 mg/L ± 15 % of reading at 25 °C
Light Source	LED with narrow band interference filter @ 525 nm
Method	Adaptation of the Turbidimetric Method

REQUIRED REAGENTS

Code	Description	Quantity
HI93722-0	Cyanuric Acid Reagent	1 packet

REAGENT SETS

HI93722-01 Reagents for 100 tests

HI93722-03 Reagents for 300 tests

For other accessories see the Accessories section.

MEASUREMENT PROCEDURE

- Select the [Cyanuric Acid](#) method using the procedure described in the Method Selection section.

- Fill the first cuvette with 10 mL of unreacted sample (up to the mark). Replace the plastic stopper and the cap.

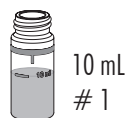

- Insert the cuvette into the holder and close the lid.

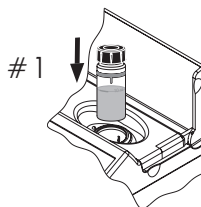

- Press **Zero**. The display will show “-0.0-” when the meter is zeroed and ready for measurement.

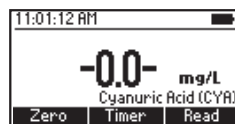
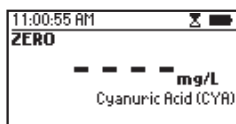
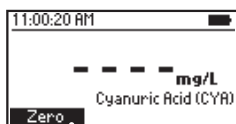

- Fill a beaker with 25 mL sample.
- Add one packet of HI93722-0 Cyanuric Acid Reagent and mix to dissolve.



- Fill a second cuvette with 10 mL of the reacted sample (up to the mark). Replace the plastic stopper and the cap.



- Insert the cuvette into the holder and close the lid.

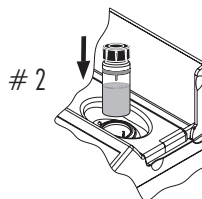

- Press **Timer** and the display will show the countdown prior to the measurement or wait 45 seconds and press **Read**. When the timer ends the meter will perform the reading. The instrument displays the concentration in mg/L of cyanuric acid.

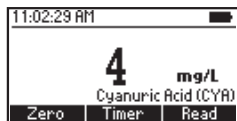
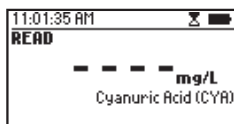
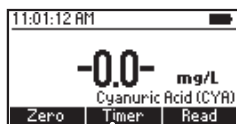

10.31. Fluoride Low Range

SPECIFICATIONS

Range	0.00 to 2.00 mg/L (as F ⁻)
Resolution	0.01 mg/L
Accuracy	±0.03 mg/L ±3 % of reading at 25 °C
Light Source	LED with narrow band interference filter @ 575 nm
Method	Adaptation of Standard Methods for the Examination of Water and Wastewater, 18 th Edition, SPADNS Method

REQUIRED REAGENT

Code	Description	Quantity
HI93729-0	Fluoride Low Range Reagent	4 mL

REAGENT SETS

HI93729-01 Reagents for 100 tests

HI93729-03 Reagents for 300 tests

For other accessories see the Accessories section.

MEASUREMENT PROCEDURE

- Select the **Fluoride LR** method using the procedure described in the Method Selection section.

- Add 2 mL of **HI93729-0** Fluoride Low Range Reagent to two cuvettes.

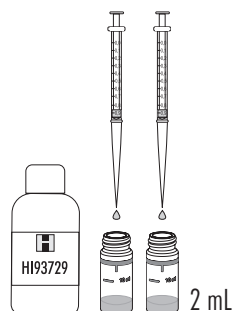

- Use a plastic pipette to fill one cuvette with 10 mL of deionized water (up to the mark) (#1). Replace the plastic stopper and the cap. Invert several times to mix.

- Use a plastic pipette to fill the second cuvette with 10 mL of unreacted sample (up to the mark) (#2). Replace the plastic stopper and the cap. Invert several times to mix.

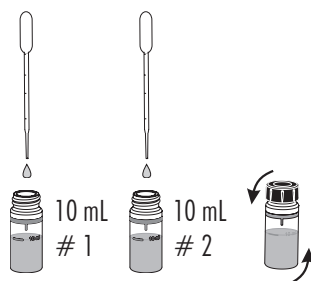

- Insert the first cuvette (#1) into the holder and close the lid.

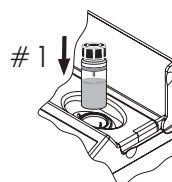

- Press **Timer** and the display will show the countdown prior to zeroing the blank or wait 2 minutes and press **Zero**. The display will show “-0.0-” when the meter is zeroed and ready for measurement.

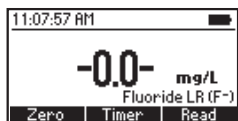
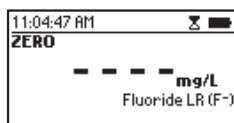
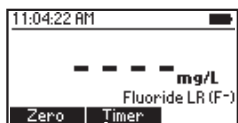

- Remove the cuvette.
- Insert the second cuvette (#2) with the reacted sample into the holder and close the lid.
- Press **Read** to start reading. The instrument displays the results in **mg/L of fluoride (F⁻)**.

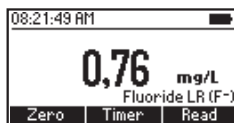
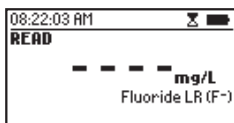
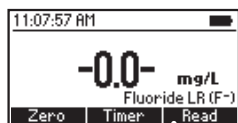
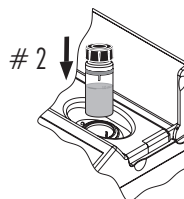

Note: For wastewater or seawater samples, before performing measurements, distillation is required. For most accurate results use two graduated pipettes to deliver exactly 8 mL of deionized water and 8 mL of sample.

INTERFERENCES

Interference may be caused by:

- Alkalinity above 5000 mg/L CaCO₃
- Chloride above 700 mg/L
- Sulfate above 200 mg/L
- Orthophosphate above 16 mg/L
- Iron (Ferric) above 10 mg/L
- Sodium hexametaphosphate above 1.0 mg/L
- Aluminum above 0.1 mg/L
- Highly colored and turbid samples may require distillation
- Highly alkaline samples can be neutralized with nitric acid

10.32. Fluoride High Range

SPECIFICATIONS

Range	0.0 to 20.0 mg/L (as F ⁻)
Resolution	0.1 mg/L
Accuracy	±0.5 mg/L ± 3 % of reading at 25 °C
Light Source	LED with narrow band interference filter @ 575 nm
Method	Adaptation of Standard Methods for the Examination of Water and Wastewater, 18 th Edition, SPADNS Method

REQUIRED REAGENT

Code	Description	Quantity
HI93739A-0	Fluoride High Range Reagent A	2 mL
HI93739B-0	Fluoride High Range Reagent B	8 mL

REAGENT SETS

HI93739-01 Reagents for 100 tests

HI93739-03 Reagents for 300 tests

For other accessories see the Accessories section.

MEASUREMENT PROCEDURE

- Select the **Fluoride HR** method using the procedure described in the Method Selection section.

- Use 1 mL syringe one and add 2 mL of **HI93739A-0** Fluoride High Range Reagent A to the cuvette. Use the pipette to fill up the cuvette to the 10 mL mark with **HI93739B-0** Fluoride High Range Reagent B.

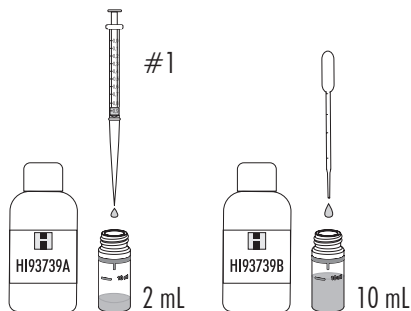

- Replace the plastic stopper and the cap. Invert several times to mix.



- Insert the cuvette into the holder and close the lid.

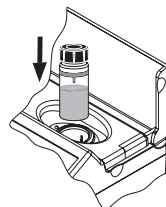

- Press **Timer** and the display will show the countdown prior to zeroing the blank or wait 1 minute and press **Zero**. The display will show “-0.0-” when the meter is zeroed and ready for measurement.

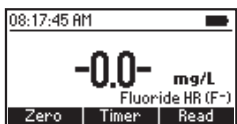
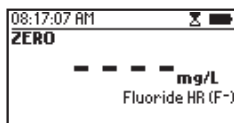
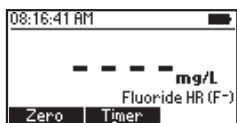

- Remove the cuvette.
- Add 1 mL of sample to the cuvette using the second 1 mL syringe.
- Replace the plastic stopper and the cap. Invert several times to mix.

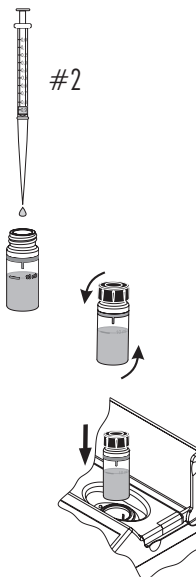

- Insert the cuvette into the holder and close the lid.

- Press **Timer** and the display will show the countdown prior to the measurement or wait 1 minute and press **Read**. When the timer ends the meter will perform the reading. The instrument displays the results in **mg/L** of fluoride (F^-).

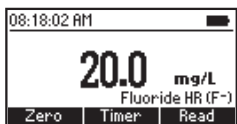
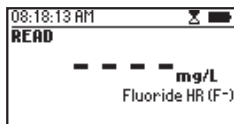
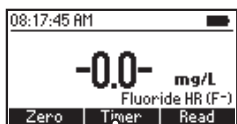

Note: For wastewater or seawater samples, before performing measurements, distillation is required.

INTERFERENCES

Interference may be caused by:

- Alkalinity above 5000 mg/L CaCO_3
- Chloride above 700 mg/L
- Sulfate above 200 mg/L
- Orthophosphate above 16 mg/L
- Aluminum above 0.1 mg/L
- Iron (Ferric) above 10 mg/L
- Sodium hexametaphosphate above 1.0 mg/L
- Highly colored and turbid samples may require distillation
- Highly alkaline samples can be neutralized with nitric acid

10.33. Hardness, Calcium

SPECIFICATIONS

Range	0.00 to 2.70 mg/L (as CaCO ₃)
Resolution	0.01 mg/L
Accuracy	±0.11 mg/L ± 5 % of reading at 25 °C
Light Source	LED with narrow band interference filter @ 525 nm
Method	Adaptation of Standard Methods for the Examination of Water and Wastewater, 18 th Edition, Calmagite Method

REQUIRED REAGENTS

Code	Description	Quantity
HI93720A-0	Calcium Hardness Reagent A	0.5 mL
HI93720B-0	Calcium Hardness Reagent B	0.5 mL
HI93720C-0	Calcium Hardness Reagent C	1 drop

REAGENT SETS

HI93720-01 Reagents for 100 tests

HI93720-03 Reagents for 300 tests

For other accessories see the Accessories section.

MEASUREMENT PROCEDURE

- Select the **Hardness (Calcium)** method using the procedure described in the Method Selection section.

- Rinse a graduated beaker several times with unreacted sample, before filling it to the 50 mL mark with the sample.

- Add 0.5 mL of **HI93720A-0** Calcium Hardness Reagent A and swirl to mix the solution.

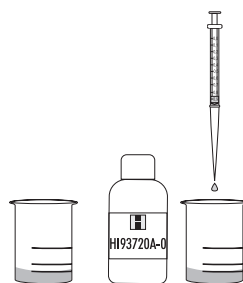

- Add 0.5 mL of **HI93720B-0** Calcium Hardness Reagent B and swirl to mix the solution. Fill two cuvettes with 10 mL of sample (up to the mark).

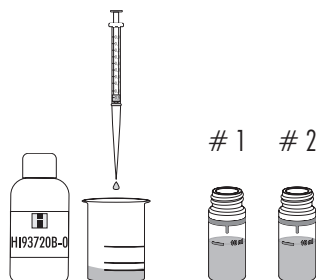

- Add 1 drop of HI93720C-0 Calcium Hardness Reagent C to one cuvette (#1).

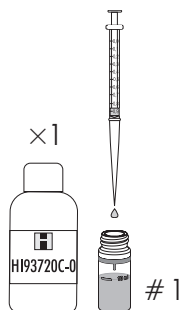

- Replace the plastic stopper and the cap. Invert the cuvette several times to mix. This is the blank.



- Insert the blank (#1) into the holder and close the lid.

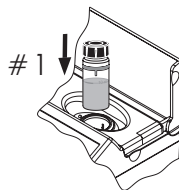

- Press **Zero**. The display will show “-0.0-” when the meter is zeroed and ready for measurement.

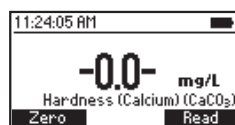
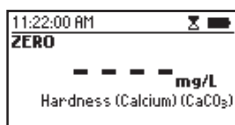
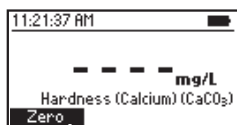

- Remove the blank (#1) and insert the second cuvette (#2) into the holder.

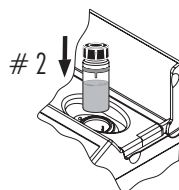

- Press **Read** to start the reading. The instrument displays concentration in mg/L of calcium carbonate (CaCO₃).

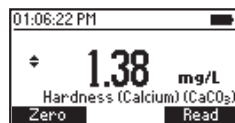
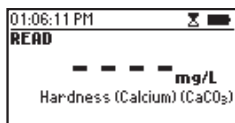
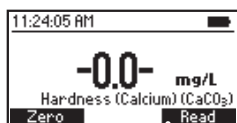

- Press the ▲ or ▼ key to access the second level functions.
- Press Chem Frm to convert the result to French degrees (°f), German degrees (°dH) and English degrees (°E).

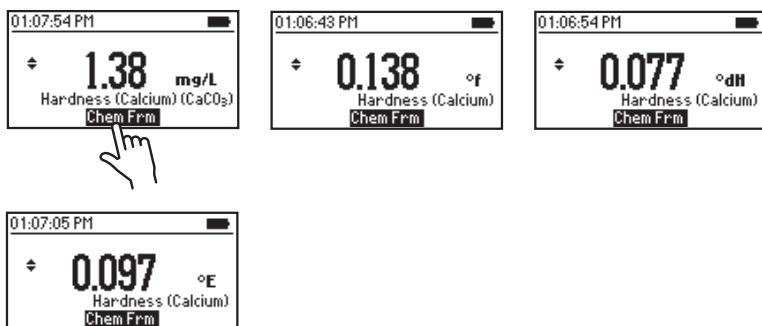

- Press the ▲ or ▼ key to return to the measurement screen.

Note: This test will detect any calcium contamination in the beaker, measuring syringes or sample cells. To test cleanliness repeat the test multiple times until you obtain consistent results.

SAMPLE DILUTION

This meter is designed to determine low levels of hardness, typically found in water purification systems. Dilutions must be performed with hardness-free water or the readings will be erroneous. To reduce the level of hardness by a factor of one hundred:

- Fill a 1 mL syringe with the sample.
- Add 0.5 mL of sample to a clean, dry 50 mL beaker.
- Fill the beaker up to the 50 mL mark with hardness-free water.

INTERFERENCES

Interference may be caused by:

- Excessive amounts of heavy metals

10.34. Hardness, Magnesium

SPECIFICATIONS

Range	0.00 to 2.00 mg/L (CaCO ₃)
Resolution	0.01 mg/L
Accuracy	±0.11 mg/L ±5 % of reading at 25 °C
Light Source	LED with narrow band interference filter @ 525 nm
Method	Adaptation of Standard Methods for the Examination of Water and Wastewater, 18 th Edition, EDTA Colorimetric Method

REQUIRED REAGENTS

Code	Description	Quantity
HI93719A-0	Magnesium Hardness Reagent A	0.5 mL
HI93719B-0	Magnesium Hardness Reagent B	0.5 mL
HI93719C-0	Magnesium Hardness Reagent C	1 drop
HI93719D-0	Magnesium Hardness Reagent D	1 drop

REAGENT SETS

HI93719-01 Reagents for 100 tests

HI93719-03 Reagents for 300 tests

For other accessories see the Accessories section.

MEASUREMENT PROCEDURE

- Select the **Hardness (Magnesium)** method using the procedure described in the Method Selection section.
- Rinse a graduated beaker several times with unreacted sample before filling it to the 50 mL mark with the sample.
- Add 0.5 mL of **HI93719A-0** Magnesium Hardness Reagent A, then swirl to mix the solution.
- Add 0.5 mL of **HI93719B-0** Magnesium Hardness Reagent B and swirl to mix the solution. Use this solution to rinse 2 cuvettes.
- Fill two cuvettes with 10 mL of sample (up to the mark).

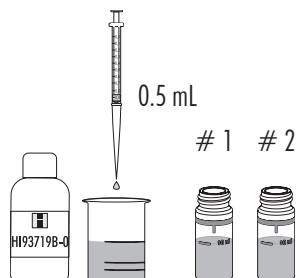
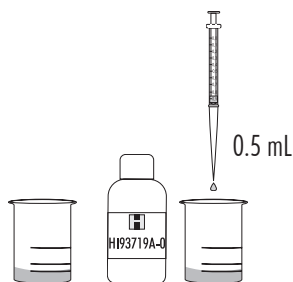

- Add 1 drop of **HI93719C-0** Magnesium Hardness Reagent C to one cuvette (#1), replace the plastic stopper and the cap. Invert the cuvette several times to mix the solution. This is the blank.

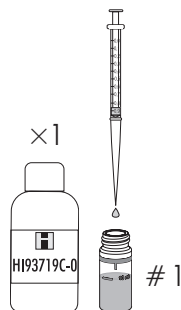

- Add 1 drop of **HI93719D-0** Magnesium Hardness Reagent D to the second cuvette (#2), replace the plastic stopper and the cap. Invert the cuvette several times to mix the solution. This is the sample.

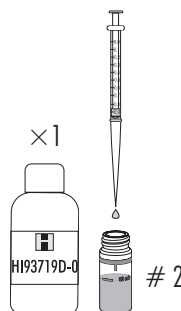

- Insert the blank (#1) into the holder and close the lid.

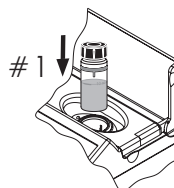

- Press **Zero**. The display will show “-0.0-” when the meter is zeroed and ready for measurement.

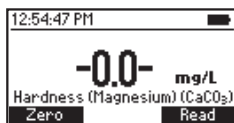
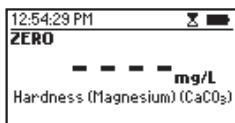
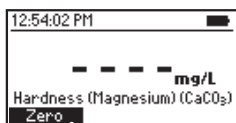

- Remove the blank (#1), insert the sample (#2) into the holder and close the lid.

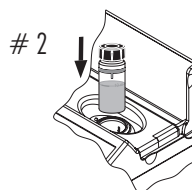

- Press **Read** to start the reading. The instrument displays concentration in **mg/L** of calcium carbonate (CaCO_3).

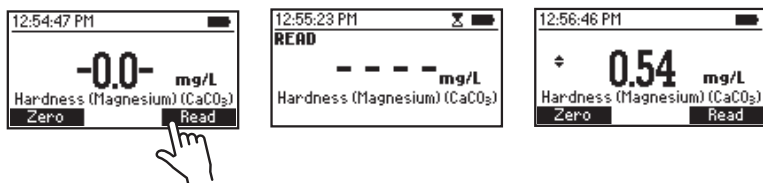

- Press the **▲** or **▼** key to access the second level functions.
- Press **Chem Frm** to convert the result to French degrees ($^{\circ}\text{f}$), German degrees ($^{\circ}\text{dH}$) and English degrees ($^{\circ}\text{E}$).

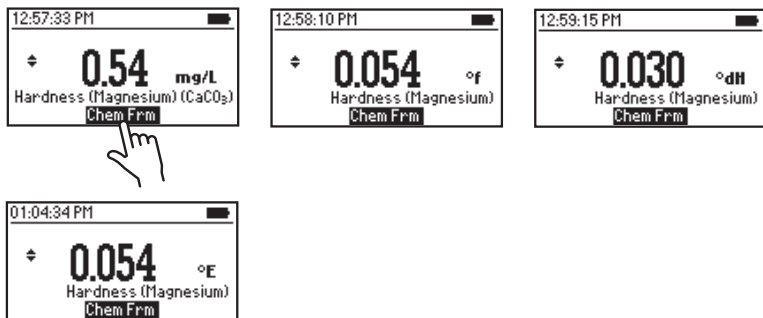

- Press the **▲** or **▼** key to return to the measurement screen.

Note: This test will detect any magnesium contamination in the beakers, measuring syringes, or sample cells. To test cleanliness repeat the test multiple times until you obtain consistent results.

SAMPLE DILUTION

This meter is designed to determine low levels of hardness, typically found in water purification systems. Dilutions must be performed with hardness-free water or the readings will be erroneous. To reduce the level of hardness by a factor of one hundred:

- Fill a 1 mL syringe with the sample.
- Add 0.5 mL of sample to a clean, dry 50 mL beaker.
- Fill the beaker up to the 50 mL mark with hardness-free water.

INTERFERENCES

Interference may be caused by:

- Excessive amounts of heavy metals

10.35. Hardness, Total Low Range

SPECIFICATIONS

Range	0 to 250 mg/L (as CaCO ₃)
Resolution	1 mg/L
Accuracy	± 5 mg/L ± 4 % of reading at 25 °C
Light Source	LED with narrow band interference filter @ 466 nm
Method	Adaptation of the EPA Recommended Method 130.1

REQUIRED REAGENTS

Code	Description	Quantity
HI93735IND-0	Hardness Indicator Reagent	0.5 mL
HI93735A-LR	Hardness Low Range Reagent A	9 mL
HI93735B-0	Hardness Buffer Reagent B	2 drops
HI93735C-0	Fixing Reagent	1 packet

REAGENT SETS

HI93735-00	Reagents for 100 tests (LR, 0 to 250 mg/L)
HI93735-0	Reagents for 300 tests (LR - 100 tests, MR - 100 tests, HR - 100 tests)

For other accessories see the Accessories section.

MEASUREMENT PROCEDURE

- Select the **Hardness Total LR** method using the procedure described in the Method Selection section.
- Add 0.5 mL of unreacted sample to the cuvette. Add 0.5 mL of **HI93735IND-0** Hardness Indicator Reagent.
- Use a plastic pipette and fill the cuvette up to the 10 mL mark with **HI93735A-LR** Hardness Low Range Reagent A.
- Add 2 drops of **HI93735B-0** Hardness Buffer Reagent B. Replace the plastic stopper and the cap. Invert 5 times to mix.

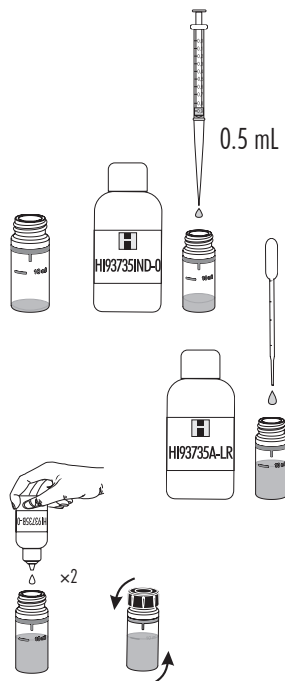

- Insert the cuvette into the holder and close the lid.

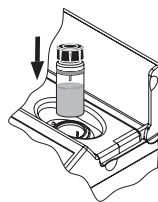

- Press **Zero**. The display will show “-0.0-” when the meter is zeroed and ready for measurement.

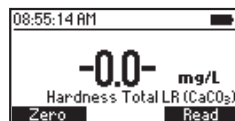
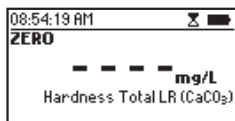
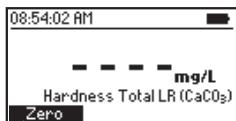

- Remove the cuvette and add the contents of one packet of **HI93735C-0** Fixing Reagent. Replace the plastic stopper and the cap. Shake gently for 20 seconds to mix the solution.



- Insert the cuvette into the holder and close the lid.

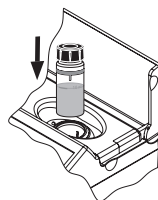

- Press **Read** to start the reading. The instrument displays concentration in **mg/L** of calcium carbonate (CaCO_3).

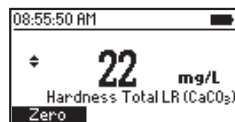
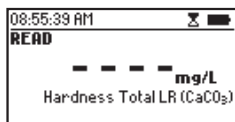
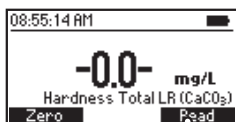

- Press the ▲ or ▼ key to access the second level functions.

- Press Chem Frm to convert the result to French degrees (°f), English degrees (°E) and German degrees (°dH).

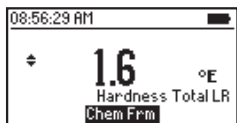
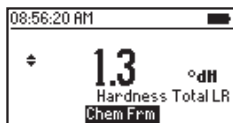
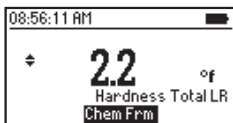
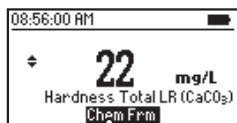

- Press the ▲ or ▼ key to return to the measurement screen.

INTERFERENCES

Interference may be caused by:

- Excessive amounts of heavy metals

10.36. Hardness, Total Medium Range

SPECIFICATIONS

Range	200 to 500 mg/L (as CaCO ₃)
Resolution	1 mg/L
Accuracy	± 7 mg/L ± 3 % of reading at 25 °C
Light Source	LED with narrow band interference filter @ 466 nm
Method	Adaptation of the EPA Recommended Method 130.1

REQUIRED REAGENTS

Code	Description	Quantity
HI93735IND-0	Hardness Indicator Reagent	0.5 mL
HI93735A-MR	Hardness Medium Reagent A	9 mL
HI93735B-0	Hardness Buffer Reagent B	2 drops
HI93735C-0	Fixing Reagent	1 packet

REAGENT SETS

HI93735-01 Reagents for 100 tests (MR, 200 to 500 mg/L)

HI93735-0 Reagents for 300 tests (LR - 100 tests, MR - 100 tests, HR - 100 tests)

For other accessories see the Accessories section.

MEASUREMENT PROCEDURE

- Select the **Hardness Total MR** method using the procedure described in the Method Selection section.
- Add 0.5 mL of unreacted sample to the cuvette. Add 0.5 mL of **HI93735IND-0** Hardness Indicator Reagent.
- Use a plastic pipette and fill the cuvette up to the 10 mL mark with **HI93735A-MR** Hardness Medium Range Reagent A.
- Add two drops of **HI93735B-0** Hardness Buffer Reagent B. Replace the plastic stopper and the cap. Invert 5 times to mix.

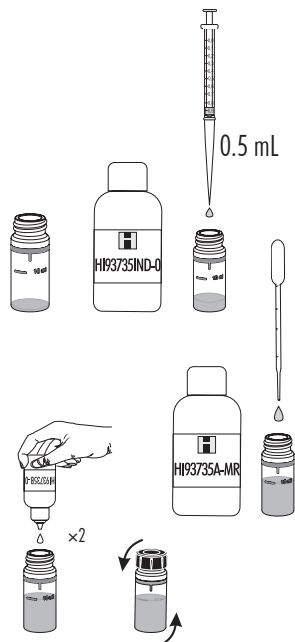

- Insert the cuvette into the holder and close the lid.

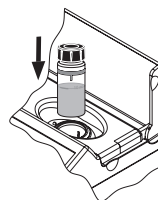

- Press **Zero**. The display will show “-0.0-” when the meter is zeroed and ready for measurement.

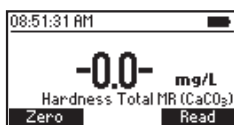
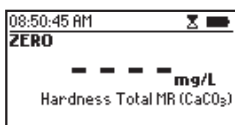
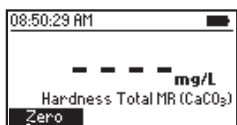

- Remove the cuvette and add one packet of [HI93735C-0](#) Fixing Reagent. Replace the plastic stopper and the cap. Shake gently for 20 seconds to mix the solution.



- Insert the cuvette into the holder and close the lid.

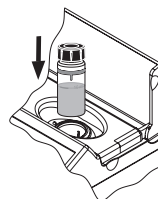

- Press **Read** to start the reading. The instrument displays concentration in **mg/L** of calcium carbonate (CaCO_3).

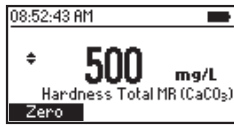
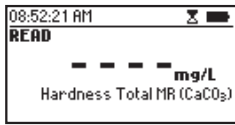
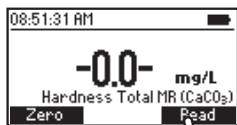

- Press the **▲** or **▼** key to access the second level functions.

- Press **Chem Frm** to convert the result to French degrees ($^{\circ}\text{f}$), English degrees ($^{\circ}\text{E}$) and German degrees ($^{\circ}\text{dH}$).

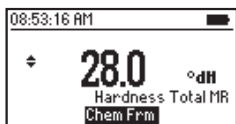
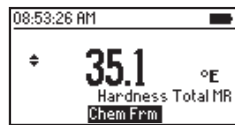
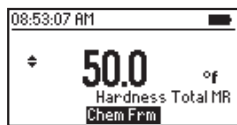
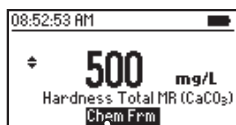

- Press the ▲ or ▼ key to return to the measurement screen.

INTERFERENCES

Interference may be caused by:

- Excessive amounts of heavy metals

10.37. Hardness, Total High Range

SPECIFICATIONS

Range	400 to 750 mg/L (as CaCO ₃)
Resolution	1 mg/L
Accuracy	± 10 mg/L ± 2 % of reading at 25 °C
Light Source	LED with narrow band interference filter @ 466 nm
Method	Adaptation of the EPA Recommended Method 130.1

REQUIRED REAGENTS

Code	Description	Quantity
HI93735IND-0	Hardness Indicator Reagent	0.5 mL
HI93735A-HR	Hardness High Range Reagent A	9 mL
HI93735B-0	Hardness Buffer Reagent B	2 drops
HI93735C-0	Fixing Reagent	1 packet

REAGENT SETS

HI93735-02 Reagents for 100 tests (HR, 400 to 750 mg/L)

HI93735-0 Reagents for 300 tests (LR - 100 tests, MR - 100 tests, HR - 100 tests)

For other accessories see the Accessories section.

MEASUREMENT PROCEDURE

- Select the **Total Hardness HR** method using the procedure described in the Method Selection section.

- Add 0.5 mL of unreacted sample to the cuvette. Add 0.5 mL of **HI93735IND-0** Hardness Indicator Reagent.

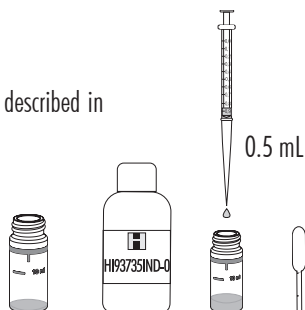

- Use a plastic pipette and fill the cuvette up to the 10 mL mark with **HI93735A-HR** Hardness High Range Reagent A.

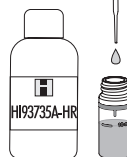

- Add two drops of **HI93735B-0** Hardness Buffer Reagent B. Replace the plastic stopper and the cap. Invert 5 times to mix.

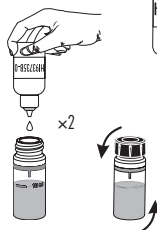

- Insert the cuvette into the holder and close the lid.

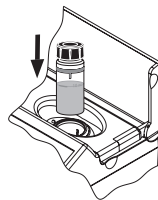

- Press **Zero**. The display will show “-0.0-” when the meter is zeroed and ready for measurement.

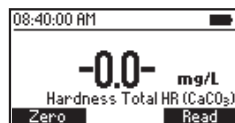
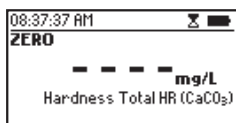
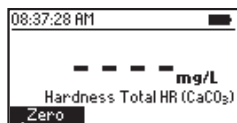

- Remove the cuvette and add one packet of [HI93735C-0](#) Fixing Reagent. Replace the plastic stopper and the cap. Shake gently for 20 seconds to mix the solution.



- Insert the cuvette into the holder and close the lid.

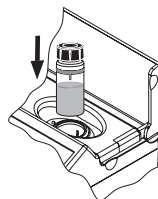

- Press **Read** to start the reading. The instrument displays concentration in **mg/L** of calcium carbonate (CaCO_3).

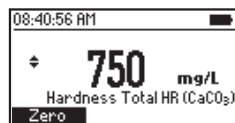
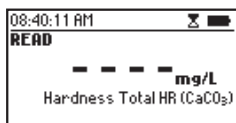
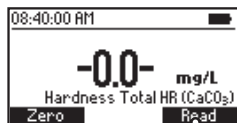

- Press the ▲ or ▼ key to access the second level functions.

- Press Chem Frm to convert the result to French degrees (°f), English degrees (°E) and German degrees (°dH).

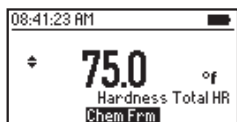
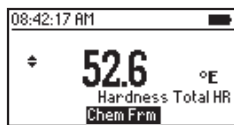
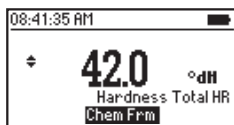
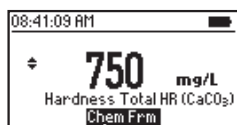

- Press the ▲ or ▼ key to return to the measurement screen.

INTERFERENCES

Interference may be caused by:

- Excessive amounts of heavy metals

10.38. Hydrazine

SPECIFICATIONS

Range	0 to 400 $\mu\text{g/L}$ (as N_2H_4)
Resolution	1 $\mu\text{g/L}$
Accuracy	$\pm 4\%$ of full scale reading at 25 °C
Light Source	LED with narrow band interference filter @ 466 nm
Method	Adaptation of the ASTM Manual of Water and Environmental Technology, Method D1385, p-Dimethylaminobenzaldehyde Method

REQUIRED REAGENT

Code	Description	Quantity
HI93704-0	Hydrazine Reagent	24 drops

REAGENT SETS

HI93704-01 Reagents for 100 tests

HI93704-03 Reagents for 300 tests

For other accessories see the Accessories section.

MEASUREMENT PROCEDURE

- Select the **Hydrazine** method using the procedure described in the Method Selection section.

- Fill one cuvette (#1) with 10 mL of deionized water (up to the mark).



- Fill a second cuvette (#2) with 10 mL of unreacted sample (up to the mark).



- Add 12 drops of the **HI93704-0** Hydrazine Reagent to each cuvette. Replace the plastic stoppers and the caps. Shake gently to mix (about 30 seconds).



- Insert the cuvette (#1) into the holder and close the lid.

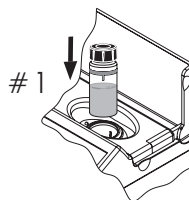

- Press **Timer** and the display will show the countdown prior to zeroing the blank or wait 12 minutes and press **Zero**. The display will show “-0.0-” when the meter is zeroed and ready for measurement.

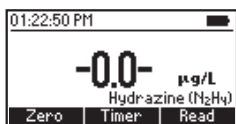
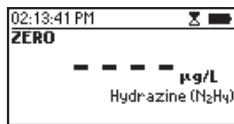
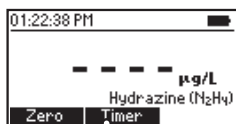

- Remove the blank.
- Insert the cuvette with the reacted sample (#2) into the holder and close the lid.

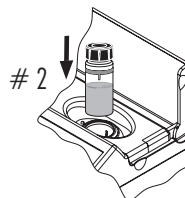

- Press **Read** to start the reading. The instrument displays concentration in $\mu\text{g/L}$ of hydrazine (N_2H_4).

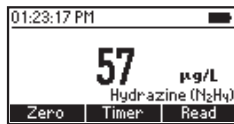
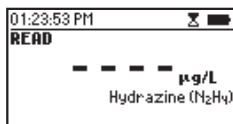
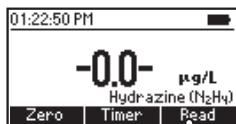

INTERFERENCES

Interference may be caused by:

- Highly colored samples
- Highly turbid samples
- Aromatic amines

10.39. Iodine

SPECIFICATIONS

Range	0.0 to 12.5 mg/L (as I ₂)
Resolution	0.1 mg/L
Accuracy	±0.1 mg/L ± 5 % of reading at 25 °C
Light Source	LED with narrow band interference filter @ 525 nm
Method	Adaptation of Standard Methods for the Examination of Water and Wastewater, 18 th Edition, DPD Method

REQUIRED REAGENTS

Code	Description	Quantity
HI93718-0	Iodine Reagent	1 packet

REAGENT SETS

HI93718-01 Reagents for 100 tests

HI93718-03 Reagents for 300 tests

For other accessories see the Accessories section.

MEASUREMENT PROCEDURE

- Select the **Iodine** method using the procedure described in the Method Selection section.

- Fill the cuvette with 10 mL of unreacted sample (up to the mark).
Replace the plastic stopper and the cap.



- Insert the cuvette into the holder and close the lid.

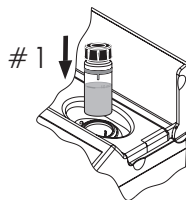

- Press **Zero**. The display will show “-0.0-” when the meter is zeroed and ready for measurement.

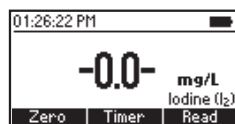
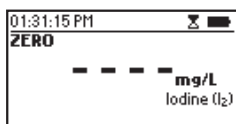
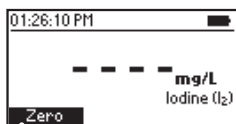

- Remove the plastic stopper and the cap and add one packet of **HI93718-0** Iodine Reagent. Replace the plastic stopper and the cap. Shake gently for about 20 seconds to dissolve most of the reagent.

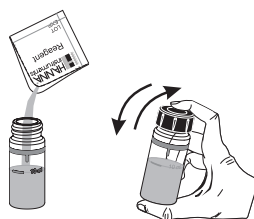

- Insert the cuvette into the holder and close the lid.

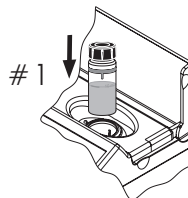

- Press **Timer** and the display will show the countdown prior to the measurement or wait 2 minutes and 30 seconds and press **Read**. When the timer ends the meter will perform the reading. The instrument displays the concentration in **mg/L of Iodine (I₂)**.

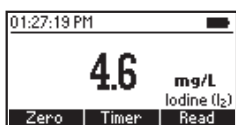
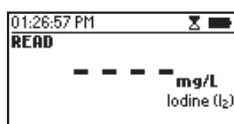
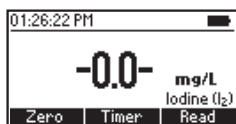

INTERFERENCES

Interference may be caused by:

- Bromine, Chlorine, Oxidized forms of Chromium and Manganese, Ozone
- Hardness greater than 500 mg/L CaCO₃, to remove the interference shake the sample for approximately 2 minutes after adding the reagent
- Alkalinity greater than 250 mg/L CaCO₃ or acidity greater than 150 mg/L CaCO₃, the color of the sample may develop only partially or rapidly fade, to remove the interference neutralize the sample with diluted HCl or NaOH

10.40. Iron Low Range

SPECIFICATIONS

Range	0.000 to 1.600 mg/L (as Fe)
Resolution	0.001 mg/L
Accuracy	± 0.010 mg/L $\pm 8\%$ of reading at 25 °C
Light Source	LED with narrow band interference filter @ 575 nm
Method	Adaptation of the TPTZ Method

REQUIRED REAGENTS

Code	Description	Quantity
HI93746-0	Iron Low Range Reagent	2 packets

REAGENT SETS

HI93746-01 Reagents for 50 tests

HI93746-03 Reagents for 150 tests

For other accessories see the Accessories section.

MEASUREMENT PROCEDURE

- Select the **Iron LR** method using the procedure described in the Method Selection section.

- Fill one graduated mixing cylinder up to the 25 mL mark with deionized water.

- Add one packet of **HI93746-0** Iron Low Range Reagent, close the cylinder and shake vigorously for 30 seconds. This is the blank.

- Fill a cuvette with 10 mL of the blank (up to the mark). Replace the rubber stopper.

- Insert the cuvette into the holder and close the lid.

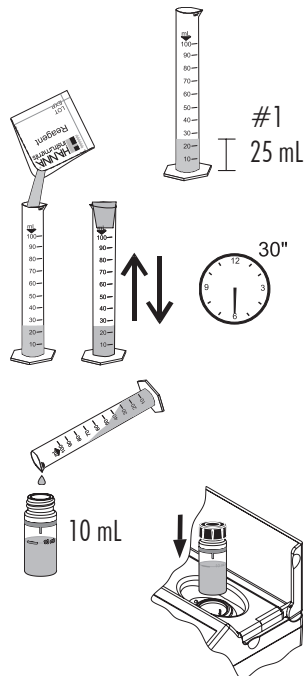

- Press **Zero**. The display will show “-0.0-” when the meter is zeroed and ready for measurement.

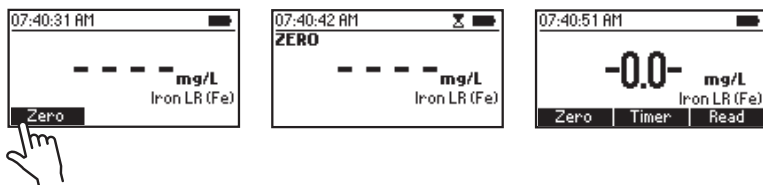

- Remove the cuvette.
- Fill another graduated mixing cylinder up to the 25 mL mark with the sample.

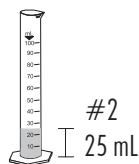

- Add one packet of **HI93746-0** Iron Low Range Reagent, close the cylinder and shake vigorously for 30 seconds. This is the reacted sample.

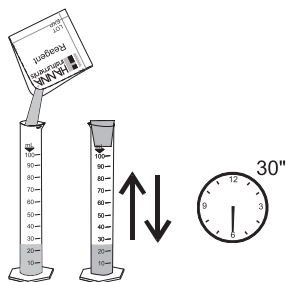

- Fill a cuvette with 10 mL of the reacted sample (up to the mark). Replace the rubber stopper.



- Insert the sample into the holder and close the lid.

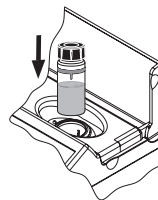

- Press **Timer** and the display will show the countdown prior to the measurement or wait 30 seconds and press **Read**. When the timer ends the meter will perform the reading. The instrument displays concentration in **mg/L** of iron (**Fe**).

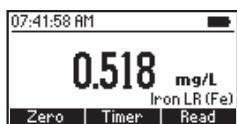
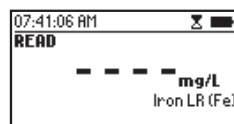
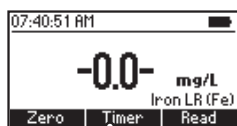

INTERFERENCES

Interference may be caused by:

- Manganese above 50.0 mg/L
- Cadmium, Molybdenum above 4.0 mg/L
- Cyanide above 2.8 mg/L
- Chromium(VI) above 1.2 mg/L
- Nickel above 1.0 mg/L
- Nitrite ion above 0.8 mg/L
- Copper above 0.6 mg/L
- Mercury above 0.4 mg/L
- Chromium(III) above 0.25 mg/L
- Cobalt above 0.05 mg/L
- Sample pH should be between 3 and 4 to avoid fading or turbidity formation

10.41. Iron High Range

SPECIFICATIONS

Range	0.00 to 5.00 mg/L (as Fe)
Resolution	0.01 mg/L
Accuracy	± 0.04 mg/L $\pm 2\%$ of reading at 25 °C
Light Source	LED with narrow band interference filter @ 525 nm
Method	Adaptation of Standard Methods for the Examination of Water and Wastewater, 23 rd Edition, 3500-Fe B, Phenanthroline Method

REQUIRED REAGENTS

Code	Description	Quantity
HI93721-0	Iron High Range Reagent	1 packet

REAGENT SETS

HI93721-01 Reagents for 100 tests

HI93721-03 Reagents for 300 tests

For other accessories see the Accessories section.

MEASUREMENT PROCEDURE

- Select the **Iron HR** method using the procedure described in the Method Selection section.

- Fill the cuvette with 10 mL of unreacted sample (up to the mark).
Replace the plastic stopper and the cap.



- Insert the cuvette into the holder and close the lid.

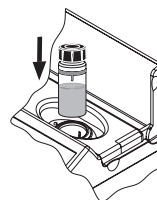

- Press **Zero**. The display will show “-0.0-” the meter is zeroed and ready for measurement.

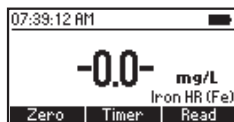
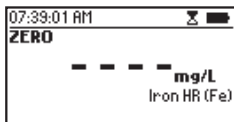
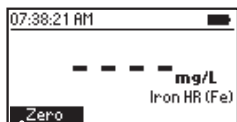

- Remove the cuvette and add the content of one packet of **HI93721-0 Iron High Range Reagent**. Replace the plastic stopper and the cap. Shake until powder is completely dissolved.

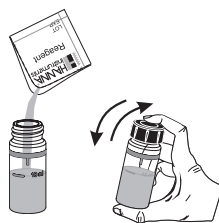

- Insert the cuvette into the holder and close the lid.

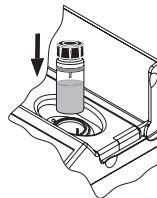

- Press **Timer** and the display will show the countdown prior to the measurement or wait 3 minutes and press **Read**. When the timer ends the meter will perform the reading. The instrument displays the result in **mg/L of iron (Fe)**.

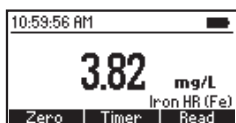
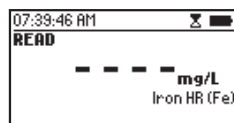

INTERFERENCES

Interference may be caused by:

- Chloride above 185000 mg/L
- Magnesium above 100000 mg/L CaCO_3
- Calcium above 10000 mg/L CaCO_3
- Molybdate Molybdenum above 50 mg/L

10.42. Iron(II)

SPECIFICATIONS

Range	0.00 to 6.00 mg/L (as Fe ²⁺)
Resolution	0.01 mg/L
Accuracy	±0.10 mg/L ± 2 % of reading at 25 °C
Light Source	LED with narrow band interference filter @ 525 nm
Method	Adaptation of Standard Methods for the Examination of Water and Wastewater, 23 rd Edition, 3500-Fe B, Phenanthroline Method

REQUIRED REAGENTS

Code	Description	Quantity
HI96776-0	Iron(II) Reagent	1 packet

REAGENTS SETS

HI96776-01	Reagents for 100 tests
HI96776-03	Reagents for 300 testss

For other accessories see the Accessories section.

PRINCIPLE

In aqueous solution, reactive ferrous iron (Fe²⁺) reacts with 1,10-phenanthroline to form an orange-red complex.

APPLICATION

Surface water, drinking water, mineral and groundwater, process control

SIGNIFICANCE & USE

Surface water typically contains up to 0.7 mg/L of iron. Drinking water typically contains up to 0.3 mg/L of iron, but this level may increase significantly if plumbing fixtures contain iron. In well-oxygenated, non-acidic waters, iron exists mainly in the ferric form (Fe³⁺) and will precipitate as iron oxide hydroxide (FeO(OH)). However, anoxic water may have high levels of dissolved ferrous iron (Fe²⁺) which could precipitate in heating/cooling systems or other equipment after exposure to air.

The Iron(II) method measures the ferrous (Fe²⁺) form of iron.

MEASUREMENT PROCEDURE

Warning: Method is temperature-dependent. Sample temperature must be between 18 and 22 °C (64 and 71 °F).

- Select the **Iron(II)** method using the procedure described in the Method Selection section.

- Fill the cuvette with 10 mL of unreacted sample (up to the mark). Replace the plastic stopper and the cap.



- Insert the cuvette into the holder and close the lid.

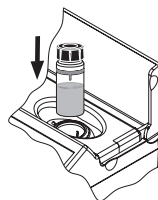

- Press **Zero**. The display will show "-0.0-" when the meter is zeroed and ready for measurement.

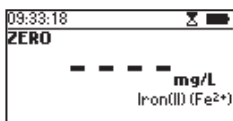
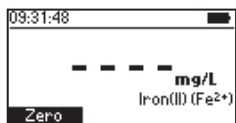

- Remove the cuvette and add the content of one packet of **HI96776-0 Iron(II) Reagent**. Replace the plastic stopper and the cap. Shake gently for 30 seconds.



- Insert the cuvette into the holder and close the lid.

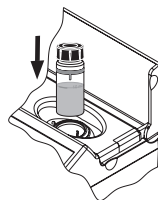

- Press **Timer** and the display will show the countdown prior to the measurement or wait 3 minutes and press **Read**. The instrument displays the result in mg/L of Iron (Fe^{2+}).

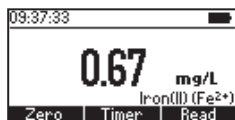
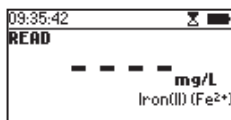
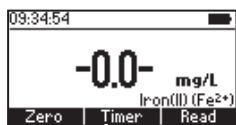

Warning: Timing is critical for accurate measurement. Reaction times beyond 3 minutes may cause some ferric iron (Fe^{3+}) to also react, producing false high measurements.

INTERFERENCES

Interference may be caused by:

- Chloride, Sulfate above 1000 mg/L
- Ammonium, Calcium, Potassium, Sodium above 500 mg/L
- Silver above 100 mg/L
- Carbonate, Chromium(III) and (VI), Cobalt, Lead, Mercury, Nitrate, Zinc above 50 mg/L
- Nickel above 25 mg/L
- Copper above 10 mg/L
- Tin above 5 mg/L
- Extreme pH or highly buffered samples, the pH of the sample must be between 3.8 and 5.5 after addition of the reagent

10.43. Iron(II)/(III)

SPECIFICATIONS

Range	0.00 to 6.00 mg/L (as Fe)
Resolution	0.01 mg/L
Accuracy	± 0.10 mg/L ± 2 % of reading at 25 °C
Light Source	LED with narrow band interference filter @ 525 nm
Method	Adaptation of Standard Methods for the Examination of Water and Wastewater, 23 rd Edition, 3500-Fe B, Phenanthroline Method

REQUIRED REAGENTS

Code	Description	Quantity
HI96777A-0	Iron(II)/(III) Reagent A	1 packet
HI96777B-0	Iron(II)/(III) Reagent B	1 packet

REAGENTS SETS

HI96777-01	Reagents for 100 tests
HI96777-03	Reagents for 300 tests

For other accessories see the Accessories section.

PRINCIPLE

During the first measurement, ferrous iron (Fe^{2+}) reacts with 1,10-phenanthroline to form an orange-red complex. During the second measurement, ferric iron (Fe^{3+}) is converted to ferrous iron (Fe^{2+}) by the addition of Reagent B; the resulting measurement is the sum of ferrous (Fe^{2+}) and ferric (Fe^{3+}) iron.

APPLICATION

Surface water, drinking water, mineral and groundwater, process control

SIGNIFICANCE & USE

Surface water typically contains up to 0.7 mg/L of iron. Drinking water typically contains up to 0.3 mg/L of iron, but this level may increase significantly if plumbing fixtures contain iron. In well-oxygenated, non-acidic waters, iron exists mainly in the ferric form (Fe^{3+}) and will precipitate as iron oxide hydroxide ($\text{FeO}(\text{OH})$). However, anoxic water may have high levels of dissolved ferrous iron (Fe^{2+}) which could precipitate in heating/cooling systems or other equipment after exposure to air.

The Iron(II)/(III) method can be used to distinguish between the ferrous (Fe^{2+}) and ferric (Fe^{3+}) forms of iron in a 2-step measurement process.

MEASUREMENT PROCEDURE

- Select the **Iron(II)/(III)** method using the procedure described in the Method Selection section.

- Fill the cuvette with 10 mL of unreacted sample (up to the mark).
Replace the plastic stopper and the cap.



- Insert the cuvette into the holder and close the lid.

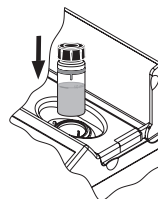

- Press **Zero**. The display will show "-0.0-" when the meter is zeroed and ready for measurement.

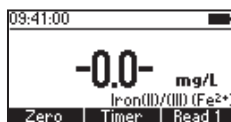
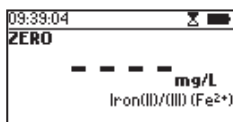
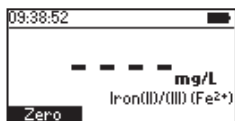

- Remove the cuvette and add the content of one packet of **HI96777A-0 Iron(II)/(III) Reagent A**. Replace the plastic stopper and the cap. Shake gently for 30 seconds.



- Insert the cuvette into the holder and close the lid.

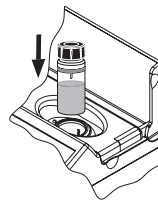

- Press **Timer** and the display will show the countdown prior to the measurement or wait 3 minutes and press **Read 1**. The instrument displays the result in **mg/L** of **Iron (Fe²⁺)**.

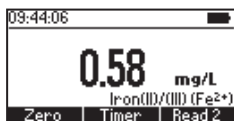
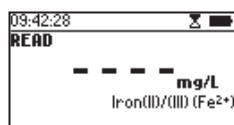
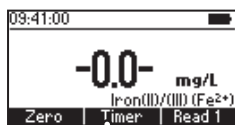

Warning: Timing is critical for accurate measurement. Reaction times beyond 3 minutes may cause some ferric iron (Fe³⁺) to also react, producing false high measurements.

- Remove the plastic stopper and the cap from the cuvette and add the content of one packet of **H196777B-0** Iron(II)/(III) Reagent B. Replace the plastic stopper and the cap. Shake gently for 30 seconds.

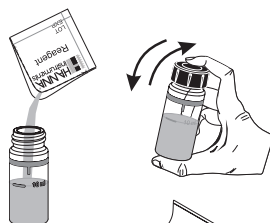

- Insert the cuvette into the holder and close the lid.

Note: If **Zero** is pressed, the instrument returns to measure **Iron(II) (Fe²⁺)**.

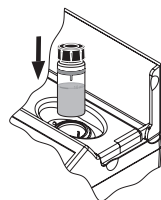

- Press **Timer** and the display will show the countdown prior to the measurement or wait 3 minutes and press **Read 2**. The instrument displays the result in **mg/L** of **Iron(III) (Fe³⁺)**.

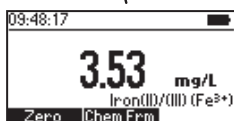
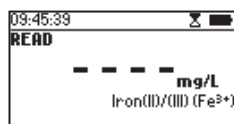
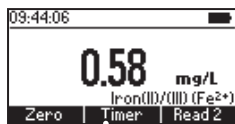

- Press **Chem Frm** to cycle through the available chemical forms of $\text{Fe}^{2+} + \text{Fe}^{3+}$ and Fe^{2+} .

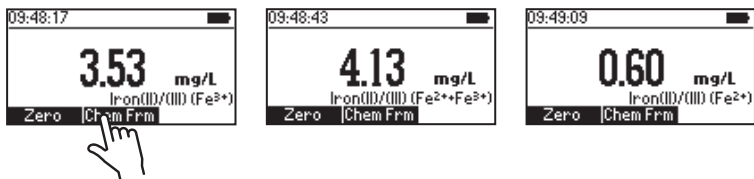

Note: Each chemical form can be logged independently by pressing the LOG key.

- Press the ▲ or ▼ key to return to the measurement screen.

INTERFERENCES

Interference may be caused by:

- Chloride, Sulfate above 1000 mg/L
- Ammonium, Calcium, Potassium, Sodium above 500 mg/L
- Silver above 100 mg/L
- Carbonate, Chromium(III) and (VI), Cobalt, Lead, Mercury, Nitrate, Zinc above 50 mg/L
- Nickel above 25 mg/L
- Copper above 10 mg/L
- Tin above 5 mg/L
- Extreme pH or highly buffered samples, the pH of the sample must be between 3.8 and 5.5 after addition of the reagents

10.44. Iron (16 mm Vial)

SPECIFICATIONS

Range	0.00 to 6.00 mg/L (as Fe)
Resolution	0.01 mg/L
Accuracy	± 0.10 mg/L or $\pm 3\%$ of reading at 25 °C
Light Source	LED with narrow band interference filter @ 525 nm
Method	Adaptation of Standard Methods for the Examination of Water and Wastewater, 23 rd Edition, 3500-Fe B, Phenanthroline Method

REQUIRED REAGENTS

Code	Description	Quantity
HI96786V-0	Iron Reagent Vial	1 vial
HI96786-0	Iron Powder Reagent	1 packet

REAGENTS SETS

HI96786-25 Reagents for 25 tests

For other accessories see the Accessories section.

Note: Store the unused vials in their packaging in a cool and dark place.

PRINCIPLE

Ferrous iron (Fe^{2+}) reacts with 1,10-phenanthroline to form an orange - red colored complex. All Fe^{3+} dissolved and not complexed or chelated is converted to ferrous iron (Fe^{2+}).

APPLICATION

Surface water, drinking water, groundwater, process control, wastewater, pool water

SIGNIFICANCE & USE

Iron is an abundant, naturally-occurring element found in soils, streams, surface water and groundwater. High levels of iron in drinking water can cause objectionable taste and can stain plumbing and laundry. Iron in drinking water and wastewater is regulated by the EPA and other regulatory bodies.

MEASUREMENT PROCEDURE

- Select the **Iron (16)** method using the procedure described in the Method Selection section.
- Insert the 16 mm vial adapter using the procedure described in the Using the 16 mm Vial Adapter section.



- Remove the cap from a **HI96786V-0** Iron Reagent Vial.



- Add 5 mL of sample to the vial, while keeping the vial at a 45-degree angle.

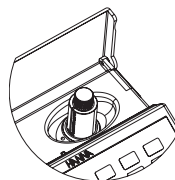

- Insert the **HI96786V-0** vial into the holder.

- Press **Zero**. The display will show "-0.0-" when the meter is zeroed and ready for measurement.

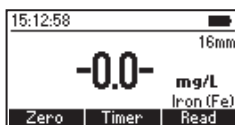
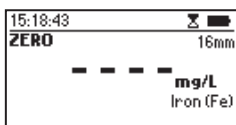
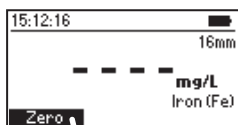

- Remove the vial from the meter.

- Remove the cap and add one packet of **HI96786-0** Iron Powder Reagent.
- Replace the cap and shake until powder is dissolved.
- Wipe the vial thoroughly with **HI731318** or a lint-free cloth prior to insertion.

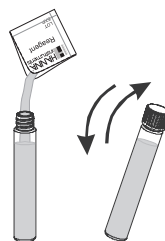

- Insert the vial into the holder.

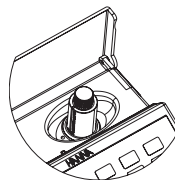

- Press **Timer** and the display will show the countdown prior to the measurement or wait 3 minutes and press **Read**. The instrument displays the result in **mg/L of Iron (Fe)**.

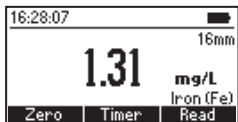
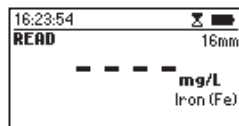
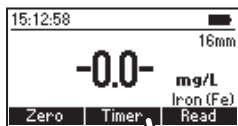

INTERFERENCES

Interference may also be caused by:

- Chloride above 185000 mg/L
- Hardness Calcium above 10000 mg/L CaCO_3
- Hardness Magnesium above 100000 mg/L CaCO_3
- Molybdate Molybdenum above 50 mg/L

10.45. Iron, Total (16 mm Vial)

SPECIFICATIONS

Range	0.00 to 7.00 mg/L (as Fe)
Resolution	0.01 mg/L
Accuracy	± 0.20 mg/L or $\pm 3\%$ of reading, whichever is greater
Light Source	LED with narrow band interference filter @ 525 nm
Method	Adaptation of Standard Methods for the Examination of Water and Wastewater, 23 rd Edition, 3500-Fe B, Phenanthroline Method

REQUIRED REAGENTS

Code	Description	Quantity
HI96778V-0*	Total Iron Digestion Vial	1 vial
HI96778A-0	Total Iron Reagent A	1 mL
HI96778B-0	Total Iron Reagent B	1 packet
PERSULFATE/1	Potassium Persulfate Reagent	1 packet

*Reagent vial identification: IRON, red label

REAGENTS SETS

HI96778-25 Reagents for 25 tests

For other accessories see the Accessories section.

Note: Store the unused vials in their packaging in a cool and dark place.

PRINCIPLE

Digestion of the sample with sulfuric acid and persulfate liberates iron from organic and inorganic complexes. After digestion, the iron reacts with 1,10-phenanthroline to form an orange-red complex.

APPLICATION

Surface water, drinking water, groundwater, process control, wastewater

SIGNIFICANCE & USE

Iron is an abundant, naturally-occurring element found in soils, streams, surface waters and groundwater. High levels of iron in drinking water can cause objectionable taste and can stain plumbing and laundry. Iron in drinking water and wastewater is regulated by the EPA and other regulatory bodies.

For samples that contain complexed or chelated iron or suspended iron, such as typical wastewater samples, digestion of the sample is required to allow all of the iron to react with the reagent.

The Total Iron method measures all forms of iron, including ferrous, ferric, dissolved, suspended and complexed iron.

SAFETY



- The acidification of samples containing reactive materials may result in the release of toxic gases, such as cyanides or sulfides; the preparation of sample and the digestion should be done in a fume hood. Safety data sheets for all chemical reagents should be read and understood by all personnel using this method. Specifically, concentrated sulfuric acid is moderately toxic and corrosive to skin and mucous membranes. Use these reagents in a fume hood whenever possible. If eye or skin contact occurs, flush with large volumes of water. Always wear skin and eye protection when working with these reagents.
- Preheat the Hanna[®] Reactor [HI839800](#) to 150 °C (302 °F). The optional [HI740217](#) safety shield is strongly recommended.
- Do not use an oven or microwave; samples may leak and generate a corrosive and possibly explosive atmosphere.

MEASUREMENT PROCEDURE

- Remove the cap from a [HI96778V-0](#) Digestion Vial.
- Add 8 mL of sample to the vial, while keeping the vial at a 45-degree angle. Replace the cap and invert several times to mix.
Warning: *The vials will become hot during mixing, use caution when handling.*

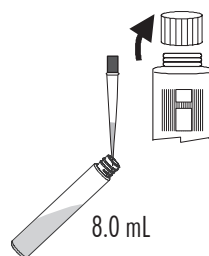

- Add one packet of [PERSULFATE/I](#) Potassium Persulfate Reagent. Replace the cap and shake the vial vigorously for 60 seconds.
- Insert the vial into the reactor and heat it for 30 minutes at 150 °C (302 °F).
- At the end of the digestion switch off the reactor. Allow the vials to cool to room temperature. Invert each vial several times and place them in the test tube rack.

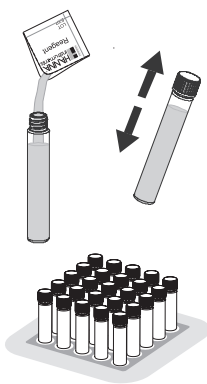

- Select the **Iron (Total) (16)** method using the procedure described in the Method Selection section.
- Insert the 16 mm vial adapter using the procedure described in the Using the 16 mm Vial Adapter section.
- Remove the cap from the vial and add 1 mL of **HI96778A-0** Total Iron Reagent A, while keeping the vial at a 45-degree angle.
- Replace the cap and invert the vial several times to mix.

Warning: The vials will become hot during mixing, use caution when handling.

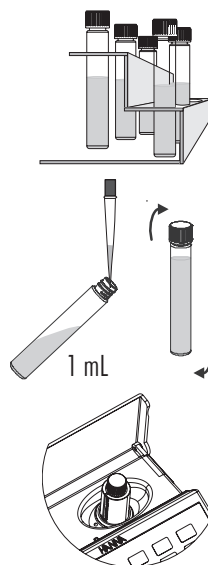

- Insert the vial into the holder.
- Press **Zero**. The display will show "-0.0-" when the meter is zeroed and ready for measurement.

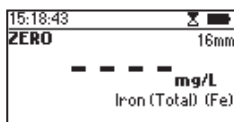
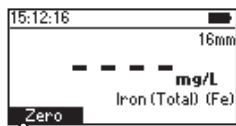

- Remove the vial from the meter.
- **Note:** The temperature of the vial must be between 18 and 22 °C (64 and 72 °F) before continuing.
- Remove the cap and add one packet of **HI96778B-0** Total Iron Reagent B.

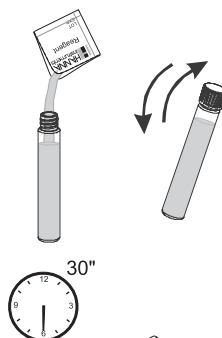

- Replace the cap and shake gently for 30 seconds.
- Insert the vial into the holder.

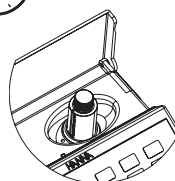

- Press **Timer** and the display will show the countdown prior to the measurement or wait 3 minutes and press **Read**. The instrument displays the result in **mg/L of Iron, Total (Fe)**.

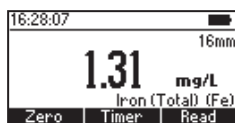
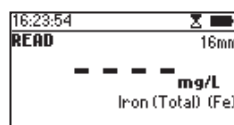
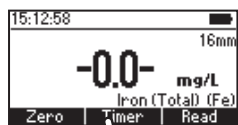

INTERFERENCES

Interference may also be caused by:

- Chloride above 185000 mg/L
- Magnesium above 100000 mg/L CaCO_3
- Calcium above 10000 mg/L CaCO_3
- Molybdate Molybdenum above 50 mg/L
- High pH or highly buffered samples the pH must be less than 1 after adding the sample to digestion vial, after addition of **HI96778A-0** Total Iron Reagent A, the pH must be 3.8 to 5.5
- If turbidity forms after digestions, filter the sample
- Samples containing suspended solids need to be homogenized before digestion

10.46. Magnesium

SPECIFICATIONS

Range	0 to 150 mg/L (as Mg ²⁺)
Resolution	1 mg/L
Accuracy	± 5 mg/L ± 3 % of reading at 25 °C
Light Source	LED with narrow band interference filter @ 466 nm
Method	Adaptation of the Calmagite Method

REQUIRED REAGENTS

Code	Description	Quantity
HI93752A-Mg	Magnesium Reagent A	1 mL
HI93752B-Mg	Magnesium Reagent B	9 mL

REAGENT SETS

HI937520-01	Reagents for 50 tests
HI937520-03	Reagents for 150 tests

For other accessories see the Accessories section.

MEASUREMENT PROCEDURE

- Select the **Magnesium** method using the procedure described in the Method Selection section.

- Add 1 mL of **HI93752A-Mg** Magnesium Reagent A to the cuvette using a 1 mL syringe and use the pipette to fill the cuvette up to the 10 mL mark with the **HI93752B-Mg** Magnesium Reagent B.

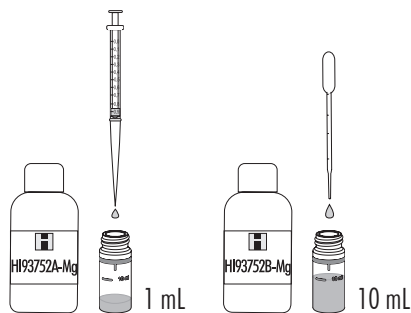

- Replace the plastic stopper and the cap. Invert several times to mix.
- Insert the cuvette into the holder and close the lid.

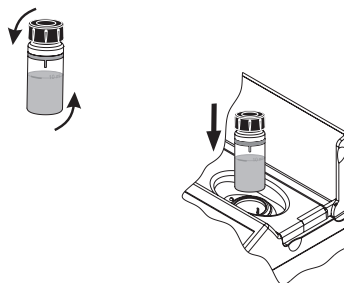

- Press **Zero**. The display will show “-0.0-” when the meter is zeroed and ready for measurement.

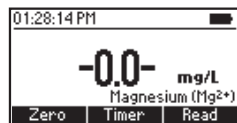
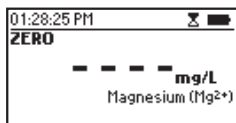
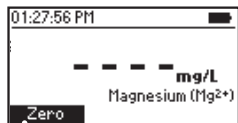

- Remove the cuvette.
- Add 0.5 mL of sample to the cuvette using the second 1 mL syringe.

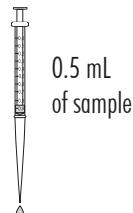

- Replace the plastic stopper and the cap. Invert several times to mix.

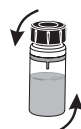

- Insert the cuvette into the holder and close the lid.

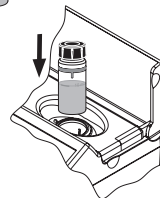

- Press **Timer** and the display will show the countdown prior to the measurement or wait 15 seconds and press **Read**. When the timer ends the meter will perform the reading. The instrument displays the results in **mg/L** of **magnesium (Mg²⁺)**.

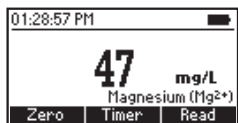
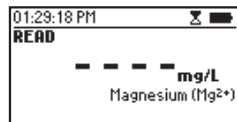
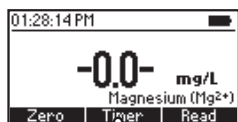

INTERFERENCES

Interference may be caused by:

- Acidity, Alkalinity above 1000 mg/L CaCO₃
- Calcium above 200 mg/L
- Aluminum, Copper, Iron must be absent

10.47. Manganese Low Range

SPECIFICATIONS

Range	0 to 300 $\mu\text{g/L}$ (as Mn)
Resolution	1 $\mu\text{g/L}$
Accuracy	$\pm 10 \mu\text{g/L} \pm 3\%$ of reading at 25 °C
Light Source	LED with narrow band interference filter @ 575 nm
Method	Adaptation of the PAN Method

REQUIRED REAGENTS

Code	Description	Quantity
HI93748A-0	Manganese Low Range Reagent A	2 packets
HI93748B-0	Manganese Low Range Reagent B	0.40 mL
HI93748C-0	Manganese Low Range Reagent C	2 mL
HI93703-51	Dispersing Agent	6 drops

REAGENT SETS

HI93748-01 Reagents for 50 tests

HI93748-03 Reagents for 150 tests

For other accessories see the Accessories section.

MEASUREMENT PROCEDURE

- Select the [Manganese LR](#) method using the procedure described in the Method Selection section.

- Fill one cuvette (#1) with 10 mL of deionized water (up to the mark).



- Fill a second cuvette (#2) with 10 mL of sample (up to the mark).

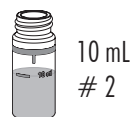

- Add one packet of [HI93748A-0](#) Manganese Low Range Reagent A to each cuvette. Replace the plastic stoppers and the caps. Shake gently until completely dissolved.

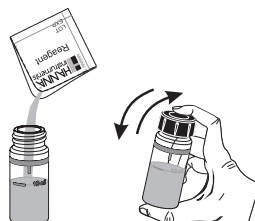

- Add 0.2 mL of the **HI93748B-0** Manganese Low Range Reagent B to each cuvette. Replace the plastic stoppers and the caps. Invert gently to mix for about 30 seconds.

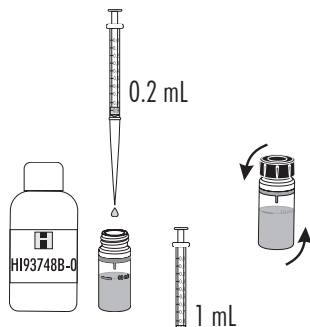

- Add 1 mL of the **HI93748C-0** Manganese Low Range Reagent C to each cuvette, replace the plastic stoppers and the caps. Shake gently.

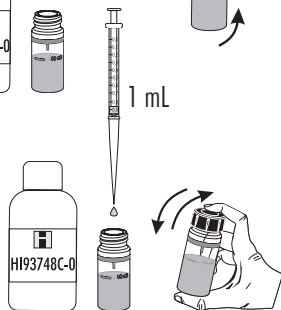

- Add 3 drops of **HI93703-51** Dispersing Agent to each cuvette. Replace the plastic stoppers and the caps. Invert gently to mix for about 30 seconds.

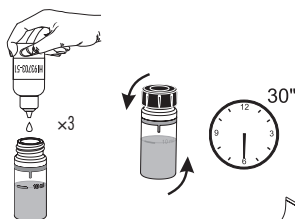

- Insert the first cuvette (#1) with the reacted deionized water into the holder and close the lid.

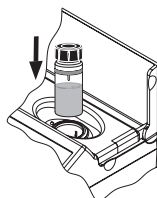

- Press **Timer** and the display will show the countdown prior to zeroing the blank or wait 2 minutes and then press **Zero**. The display will show "-0.0-" when the meter is zeroed and ready for measurement.

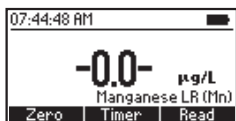
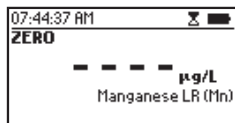
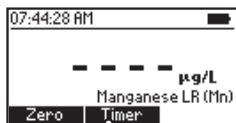

- Insert the second cuvette (#2) with the reacted sample into the holder and close the lid.

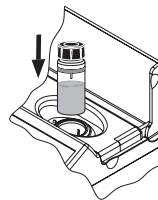

- Press **Read** to start the reading. The instrument displays the results in $\mu\text{g/L}$ of manganese (Mn).

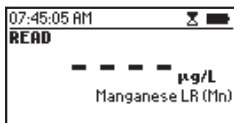
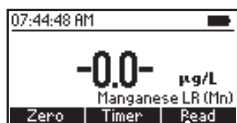

- Press the **▲** or **▼** key to access the second level functions.
- Press **Chem Frm** to convert the result to $\mu\text{g/L}$ of potassium permanganate (KMnO_4) and permanganate (MnO_4^-).

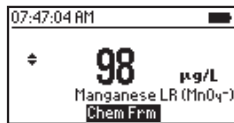
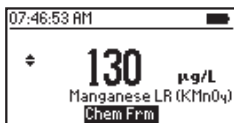
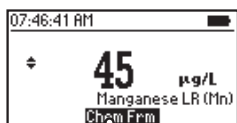

- Press the **▲** or **▼** key to return to the measurement screen.

INTERFERENCES

Interference may be caused by:

- Calcium above 200 mg/L CaCO_3
- Magnesium above 100 mg/L CaCO_3
- Copper above 50 mg/L
- Nickel above 40 mg/L
- Aluminum, Cobalt above 20 mg/L
- Zinc above 15 mg/L
- Cadmium, Iron above 10 mg/L
- Lead above 0.5 mg/L

10.48. Manganese High Range

SPECIFICATIONS

Range	0.0 to 20.0 mg/L (as Mn)
Resolution	0.1 mg/L
Accuracy	± 0.2 mg/L ± 3 % of reading at 25 °C
Light Source	LED with narrow band interference filter @ 525 nm
Method	Adaptation of Standard Methods for the Examination of Water and Wastewater, 18 th Edition, Periodate Method

REQUIRED REAGENTS

Code	Description	Quantity
HI93709A-0	Manganese High Range Reagent A	1 packet
HI93709B-0	Manganese High Range Reagent B	1 packet

REAGENT SETS

HI93709-01 Reagents for 100 tests

HI93709-03 Reagents for 300 tests

For other accessories see the Accessories section.

MEASUREMENT PROCEDURE

- Select the **Manganese HR** method using the procedure described in the Method Selection section.

- Fill the cuvette with 10 mL of unreacted sample (up to the mark).
Replace the plastic stopper and the cap.



- Insert the cuvette into the holder and close the lid.

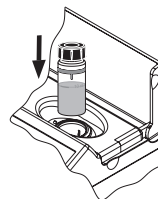

- Press **Zero**. The display will show “-0.0-” when the meter is zeroed and ready for measurement.

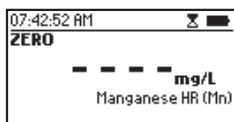
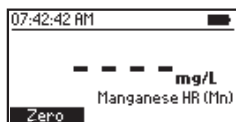

- Remove the cuvette.

- Add one packet of **HI93709A-0** Manganese High Range Reagent A. Replace the plastic stopper and the cap. Shake gently for 2 minutes to mix.

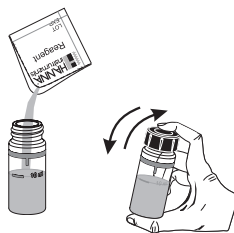

- Add one packet of **HI93709B-0** Manganese High Range Reagent B. Replace the plastic stopper and the cap. Shake gently for 2 minutes to mix.

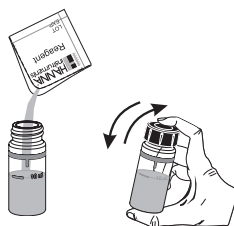

- Insert the cuvette into the holder and close the lid.

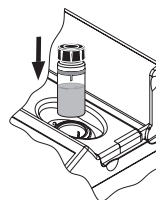

- Press **Timer** and the display will show the countdown prior to the measurement or wait 1 minute and 30 seconds and press **Read**. When the timer ends the meter will perform the reading. The instrument displays the results in **mg/L of manganese (Mn)**.

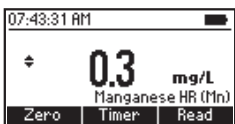
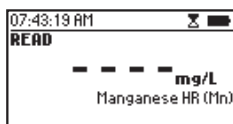
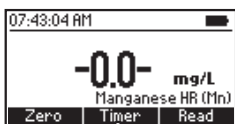

- Press the **▲** or **▼** key to access the second level functions.

- Press **Chem Frm** to convert the result to mg/L potassium permanganate (KMnO_4) and permanganate (MnO_4^-).

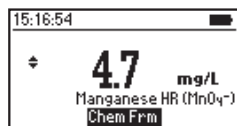
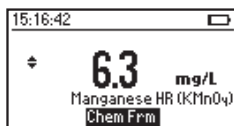
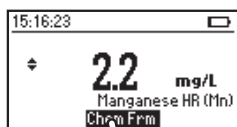

- Press the ▲ or ▼ key to return to the measurement screen.

INTERFERENCES

Interference may be caused by:

- Magnesium above 100000 mg/L
- Chloride above 70000 mg/L
- Calcium above 700 mg/L
- Iron above 5 mg/L

10.49. Molybdenum

SPECIFICATIONS

Range	0.0 to 40.0 mg/L (as Mo ⁶⁺)
Resolution	0.1 mg/L
Accuracy	±0.3 mg/L ±5 % of reading at 25 °C
Light Source	LED with narrow band interference filter @ 420 nm
Method	Adaptation of the Mercaptoacetic Acid Method

REQUIRED REAGENTS

Code	Description	Quantity
HI93730A-0	Molybdenum Reagent A	1 packet
HI93730B-0	Molybdenum Reagent B	1 packet
HI93730C-0	Molybdenum Reagent C	1 packet

REAGENT SETS

HI93730-01	Reagents for 100 tests
HI93730-03	Reagents for 300 tests

For other accessories see the Accessories section.

MEASUREMENT PROCEDURE

- Select the **Molybdenum** method using the procedure described in the Method Selection section.

- Fill the cuvette with 10 mL of unreacted sample (up to the mark).
Replace the plastic stopper and the cap.



- Insert the cuvette into the holder and close the lid.

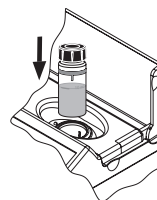

- Press **Zero**. The display will show “-0.0-” when the meter is zeroed and ready for measurement.

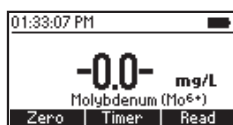
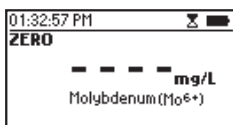
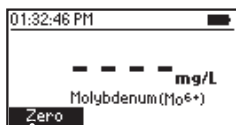

- Fill one graduated mixing cylinder up to the 25 mL mark with the sample.

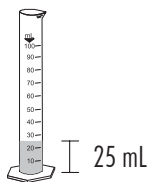

- Add one packet of **HI93730A-0** Molybdenum Reagent A to the cylinder, close and invert several times until completely dissolved.

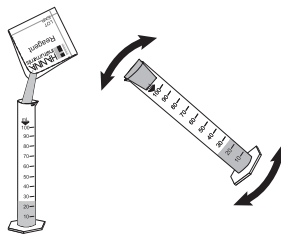

- Add one packet of **HI93730B-0** Molybdenum Reagent B to the cylinder, close and invert several times until completely dissolved.

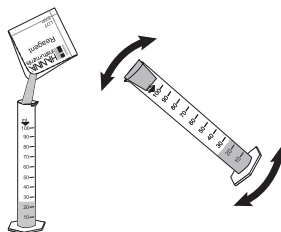

- Add one packet of **HI93730C-0** Molybdenum Reagent C to the cylinder, close and shake vigorously.

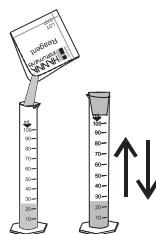

- Fill an empty cuvette with 10 mL of reacted sample (up to the mark). Replace the plastic stopper and the cap.



- Insert the cuvette into the holder and close the lid.

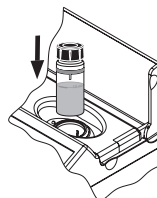

- Press **Timer** and the display will show the countdown prior to the measurement or wait 5 minutes and press **Read**. When the timer ends the meter will perform the reading. The instrument displays concentration in mg/L of **molybdenum (Mo^{6+})**.

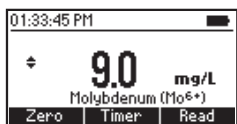
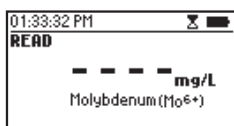
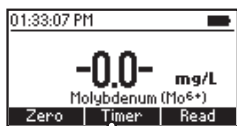

- Press the **▲** or **▼** key to access the second level functions.
- Press **Chem Frm** to convert the result to mg/L of **molybdate (MoO_4^{2-})** and **sodium molybdate (Na_2MoO_4)**.

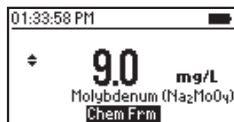
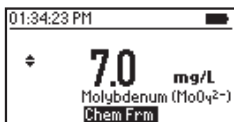
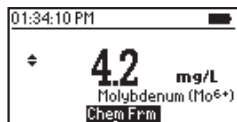

- Press the **▲** or **▼** key to return to the measurement screen.

INTERFERENCES

Interference may be caused by:

- Chromium above 1000 mg/L
- Sulfate above 200 mg/L
- Aluminum, Iron, Nickel above 50 mg/L
- Copper above 10 mg/L
- Nitrite must be absent
- Highly buffered samples or samples with extreme pH may exceed the buffering capacity of the reagents

10.50. Nickel Low Range

SPECIFICATIONS

Range	0.000 to 1.000 mg/L (as Ni)
Resolution	0.001 mg/L
Accuracy	± 0.010 mg/L $\pm 7\%$ of reading at 25 °C
Light Source	LED with narrow band interference filter @ 575 nm
Method	Adaptation of the PAN method

REQUIRED REAGENTS

Code	Description	Quantity
HI93740A-0	Nickel Low Range Reagent A	2 packets
HI93740B-0	Nickel Low Range Reagent B	2 mL
HI93740C-0	Nickel Low Range Reagent C	2 packets
HI93703-51	Dispersing Agent (optional reagent)	4-6 drops

REAGENT SETS

HI93740-01 Reagents for 50 tests

HI93740-03 Reagents for 150 tests

For other accessories see the Accessories section.

MEASUREMENT PROCEDURE

- Select the **Nickel LR** method using the procedure described in the Method Selection section.

Note: For best results samples should be between 20 and 24 °C (68 and 75 °F).

- Fill one graduated beaker with 25 mL of deionized water (blank) and another one with 25 mL of sample.

- Add one packet of **HI93740A-0** Nickel Low Range Reagent A to each beaker. Cap and swirl gently until the reagent is dissolved.

Note: If sample contains iron (Fe^{3+}), it is important that all powder is dissolved before continuing.

- Add 1 mL of **HI93740B-0** Nickel Low Range Reagent B to each beaker and swirl to mix.

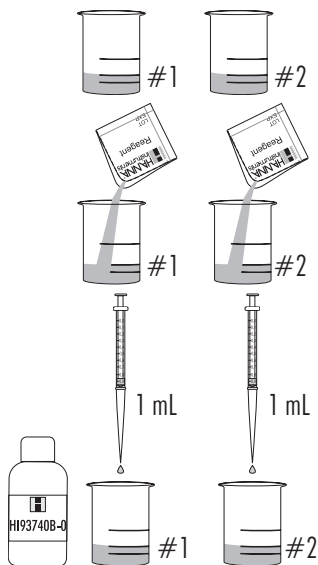

- Press **Timer** and the display will show a countdown or wait 15 minutes.

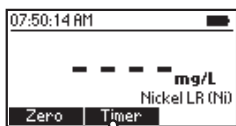

- Add one packet of **HI93740C-0** Nickel Low Range Reagent C to each beaker, cap and swirl to mix until completely dissolved.



- Fill one cuvette (#1) with 10 mL of the blank (up to the mark). Replace the plastic stopper and the cap.



- Insert the cuvette into the holder and close the lid.

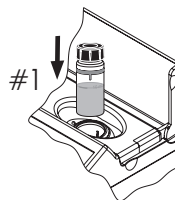

- Press **Zero**. The display will show “-0.0-” when the meter is zeroed and ready for measurement.

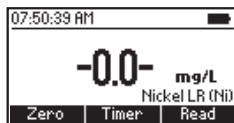
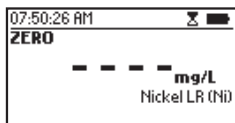
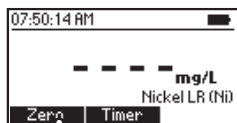

- Fill a second cuvette (#2) with 10 mL of the reacted sample (up to the mark). Replace the plastic stopper and the cap.



- Insert the second cuvette into the holder and close the lid.

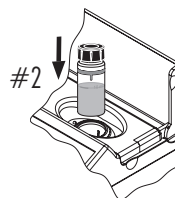

- Press **Read** to start the reading. The instrument displays the results in mg/L of nickel (Ni).

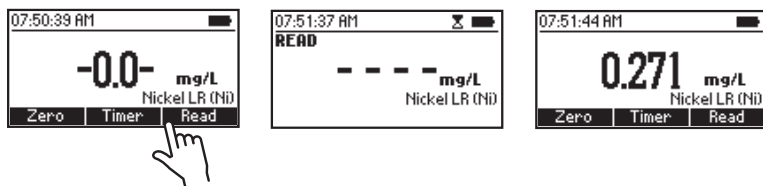

Note: A temperature above 30 °C (86 °F) may cause turbidity. In this case, add 2 to 3 drops of [HI93703-51](#) Dispersing Agent to each cuvette and swirl until turbidity is removed before zeroing the meter and reading the sample.

INTERFERENCES

Interference may be caused by:

- Chloride above 8000 mg/L
- Sodium above 5000 mg/L
- Calcium above 1000 mg/L CaCO₃
- Potassium above 500 mg/L
- Magnesium above 400 mg/L
- Molybdenum above 60 mg/L
- Chromium(VI) above 40 mg/L
- Aluminum above 32 mg/L
- Zinc above 30 mg/L
- Manganese above 25 mg/L
- Cadmium, Chromium(III), Fluoride, Lead above 20 mg/L
- Copper above 15 mg/L
- Iron (Ferric) above 10 mg/L
- Cobalt, Iron (Ferrous) must not be present

10.51. Nickel High Range

SPECIFICATIONS

Range	0.00 to 7.00 g/L (as Ni)
Resolution	0.01 g/L
Accuracy	$\pm 0.07 \text{ g/L} \pm 4\%$ of reading at 25 °C
Light Source	LED with narrow band interference filter @ 575 nm
Method	Adaptation of the Photometric Method

REQUIRED REAGENTS

Code	Description	Quantity
HI93726-0	Nickel High Range Reagent	1 packet

REAGENT SETS

HI93726-01 Reagents for 100 tests

HI93726-03 Reagents for 300 tests

For other accessories see the Accessories section.

MEASUREMENT PROCEDURE

- Select the **Nickel HR** method using the procedure described in the Method Selection section.

- Fill the cuvette with 10 mL of unreacted sample (up to the mark).
Replace the plastic stopper and the cap.



- Insert the cuvette into the holder and close the lid.

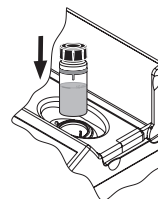

- Press **Zero**. The display will show “-0.0-” when the meter is zeroed and ready for measurement.

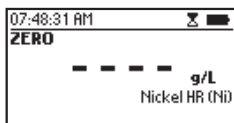
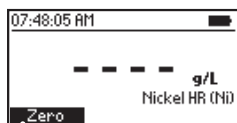

- Remove the cuvette and add one packet of **HI93726-0 Nickel High Range Reagent**. Replace the plastic stopper and the cap. Shake gently until completely dissolved.

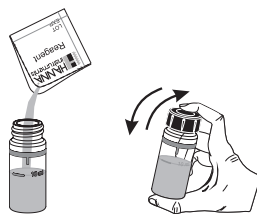

- Insert the cuvette into the holder and close the lid.

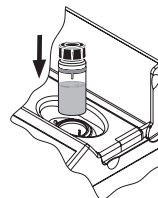

- Press **Timer** and the display will show the countdown prior to the measurement or wait 1 minute and press **Read**. When the timer ends the meter will perform the reading. The instrument displays the concentration in **g/L of nickel (Ni)**.

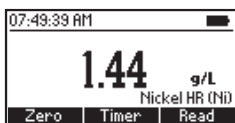
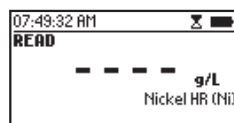

INTERFERENCES

Interference may be caused by:

- Copper

10.52. Nitrate

SPECIFICATIONS

Range	0.0 to 30.0 mg/L (as NO_3^- -N)
Resolution	0.1 mg/L
Accuracy	± 0.5 mg/L ± 10 % of reading at 25 °C
Light Source	LED with narrow band interference filter @ 525 nm
Method	Adaptation of the Cadmium Reduction Method

REQUIRED REAGENTS

Code	Description	Quantity
HI93728-0	Nitrate Reagent	1 packet

REAGENT SETS

HI93728-01 Reagents for 100 tests

HI93728-03 Reagents for 300 tests

For other accessories see the Accessories section.

MEASUREMENT PROCEDURE

- Select the [Nitrate](#) method using the procedure described in the Method Selection section.

- Fill the cuvette with 10 mL of sample (up to the mark). Replace the plastic stopper and the cap.



- Insert the cuvette into the holder and close the lid.

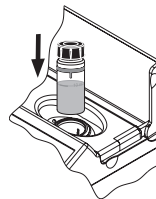

- Press **Zero**. The display will show “-0.0-” when the meter is zeroed and ready for measurement.

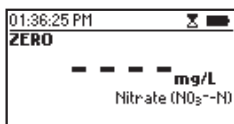
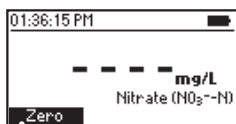

- Remove the cuvette and add one packet of HI93728-0 Nitrate Reagent.



- Replace the plastic stopper and the cap. Shake vigorously up and down for exactly 10 seconds. Continue to mix by inverting the cuvette gently for 50 seconds, while taking care not to induce air bubbles. Powder will not completely dissolve.

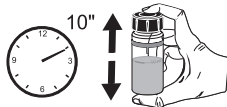

Note: The method is technique sensitive. See procedure described in the Cuvette Preparation section for proper mixing technique.

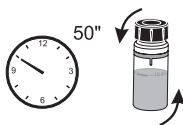

- Insert the cuvette into the holder and close the lid.

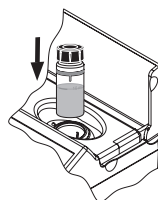

- Press **Timer** and the display will show the countdown prior to the measurement or wait 4 minutes and 30 seconds and press **Read**. When the timer ends the meter will perform the reading. The instrument displays the results in mg/L of nitrate-nitrogen ($\text{NO}_3\text{-N}$).

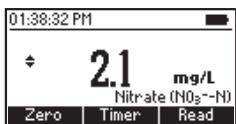
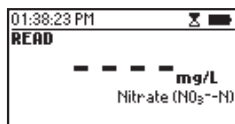
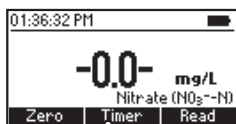

- Press the ▲ or ▼ key to access the second level functions.

- Press **Chem Frm** to convert the result to mg/L of nitrate (NO_3^-).

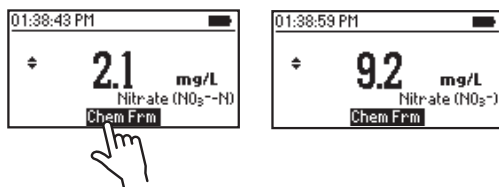

- Press the ▲ or ▼ key to return to the measurement screen.

INTERFERENCES

Interference may be caused by:

- Ammonia and amines, as urea and primary aliphatic amines
- Chloride above 100 mg/L
- Chlorine above 2 mg/L
- Copper, Iron (Ferric), Strong oxidizing and reducing substances
- Sulfide must be absent

10.53. Nitrate (16 mm Vial)

SPECIFICATIONS

Range	0.0 to 30.0 mg/L (as NO_3^- -N)
Resolution	0.1 mg/L
Accuracy	± 1.0 mg/L or $\pm 3\%$ of reading at 25 °C, whichever is greater
Light Source	LED with narrow band interference filter @ 420 nm
Method	Chromotropic Acid Method

REQUIRED REAGENTS

Code	Description	Quantity
HI93766V-0*	Nitrate Reagent Vial	1 vial
HI93766-0	Nitrate Reagent	1 packet

* Reagent vial identification: N, white label

REAGENT SETS

HI93766-50 Reagents for 50 tests

For other accessories see the Accessories section.

Note: Store the unused vials in their packaging in a cool and dark place.

MEASUREMENT PROCEDURE



Before using the reagent kit carefully read all the instructions and the Safety Data Sheets (SDS). Pay particular attention to all warnings, cautions and notes. Failure to do so may result in serious injury to the operator.

- Select the **Nitrate (16)** method using the procedure described in the Method Selection section.
- Insert the 16 mm vial adapter using the procedure described in the Using the 16 mm Vial Adapter section.

- Remove the cap from a HI93766V-0 Nitrate Reagent Vial.



- Add 1 mL of sample to the vial, while keeping the vial at a 45-degree angle.

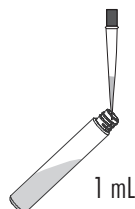

- Replace the cap and invert the vial 10 times. This is the blank.

WARNING: The vial will become hot during mixing. Use caution when handling.

Note: The method is technique sensitive. See procedure described in the Cuvette Preparation section for proper mixing technique.

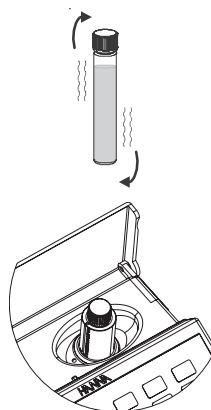

- Insert the vial into the holder.
- Press **Zero**. The display will show “-0.0-” when the meter is zeroed and ready for measurement.

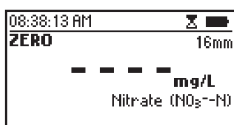
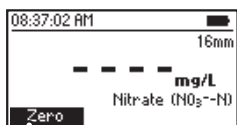

- Remove the vial.
- Add one packet of [HI93766-0](#) Nitrate Reagent.

- Replace the cap and invert the vial 10 times.

Note: The method is technique sensitive. See procedure described in the Cuvette Preparation section for proper mixing technique.

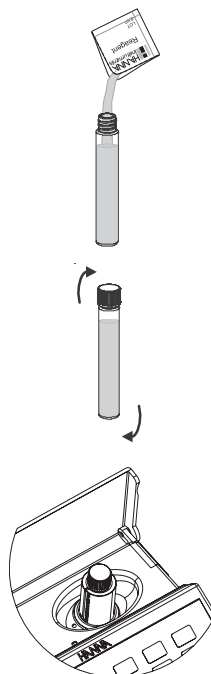

- Insert the vial into the holder.

- Press **Timer** and the display will show the countdown prior to the measurement or wait 5 minutes and press **Read**. The instrument displays the concentration in **mg/L** of nitrate-nitrogen (NO_3^- -N).

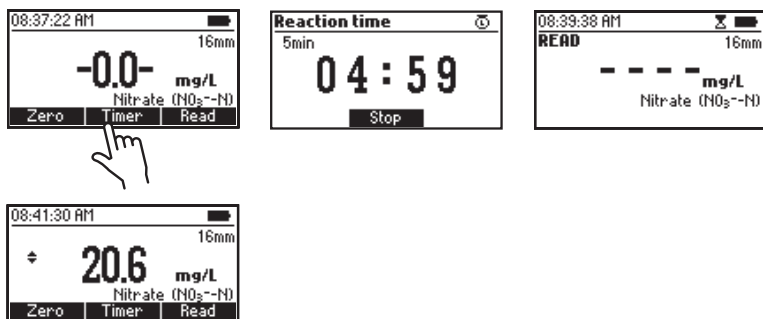

- Press the **▲** or **▼** key to access the second level functions.
- Press **Chem Frm** to convert the result in **mg/L** of nitrate (NO_3^-).

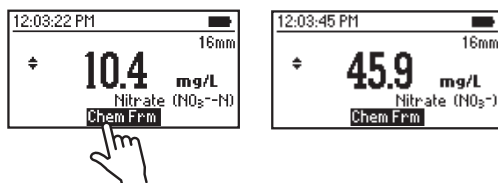

- Press the **▲** or **▼** key to return to the measurement screen.

INTERFERENCES

Interference may be caused by:

- Chloride above 1000 mg/L
- For samples containing up to 100 mg/L nitrite, add 400 mg of urea to 10 mL of sample, mix until completely dissolved, then proceed with the usual measurement procedure
- Nitrite above 50 mg/L
- Barium above 1 mg/L

10.54. Nitrite, Marine Ultra Low Range

SPECIFICATIONS

Range	0 to 200 $\mu\text{g/L}$ (as NO_2^- -N)
Resolution	1 $\mu\text{g/L}$
Accuracy	$\pm 10 \mu\text{g/L} \pm 4\%$ of reading at 25 °C
Light Source	LED with narrow band interference filter @ 466 nm
Method	Adaptation of the EPA Diazotization Method 354.1

REQUIRED REAGENTS

Code	Description	Quantity
HI764-25	Nitrite Ultra Low Range Reagent	1 packet

REAGENT SETS

HI764-25 Reagents for 25 tests
For other accessories see the Accessories section.

MEASUREMENT PROCEDURE

- Select the **Nitrite, Marine ULR** method using the procedure described in the Method Selection section.

- Fill the cuvette with 10 mL of unreacted sample (up to the mark).
Replace the plastic stopper and the cap.



- Insert the cuvette into the holder and close the lid.

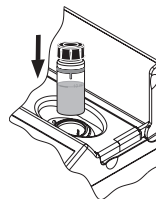

- Press **Zero**. The display will show “-0.0-” when the meter is zeroed and ready for measurement.

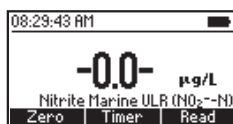
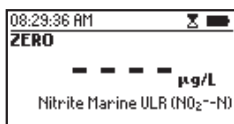
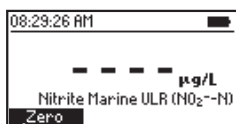

- Remove the cuvette.
- Add one packet of **HI764-25** Nitrite Ultra Low Range Reagent. Replace the plastic stopper and the cap. Shake gently for about 15 seconds.

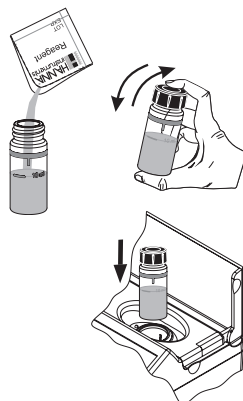

- Insert the cuvette into the holder and close the lid.
- Press **Timer** and the display will show the countdown prior to the measurement or wait 15 minutes and press **Read**. When the timer ends the meter will perform the reading. The instrument displays concentration in $\mu\text{g/L}$ of nitrite-nitrogen (NO_2^--N).

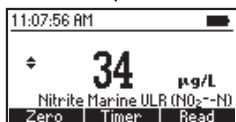
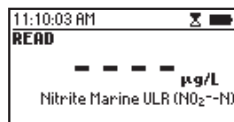
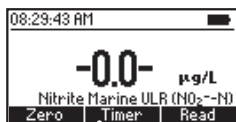

- Press the **▲** or **▼** key to access the second level functions.
- Press **Chem Frm** to convert the result to $\mu\text{g/L}$ of nitrite (NO_2^-) and sodium nitrite (NaNO_2).

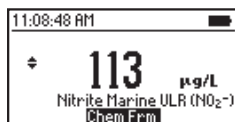
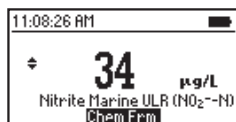

- Press the **▲** or **▼** key to return to the measurement screen.

INTERFERENCES

Interference may be caused by:

- Antimonious, Auric, Bismuth, Chloroplatinate ions, Cupric, Iron (Ferric), Iron (Ferrous), Lead, Mercurous, Silver, Strong reducing or oxidating agents
- Nitrate above 100 mg/L could yield falsely high readings

10.55. Nitrite Low Range

SPECIFICATIONS

Range	0 to 600 $\mu\text{g/L}$ (as NO_2^- -N)
Resolution	1 $\mu\text{g/L}$
Accuracy	$\pm 20 \mu\text{g/L} \pm 4\%$ of reading at 25 °C
Light Source	LED with narrow band interference filter @ 466 nm
Method	Adaptation of the EPA Diazotization Method 354.1

REQUIRED REAGENTS

Code	Description	Quantity
HI93707-0	Nitrite Low Range Reagent	1 packet

REAGENT SETS

HI93707-01 Reagents for 100 tests

HI93707-03 Reagents for 300 tests

For other accessories see the Accessories section.

MEASUREMENT PROCEDURE

- Select the **Nitrite LR** method using the procedure described in the Method Selection section.

- Fill the cuvette with 10 mL of unreacted sample (up to the mark).
Replace the plastic stopper and the cap.



- Insert the cuvette into the holder and close the lid.

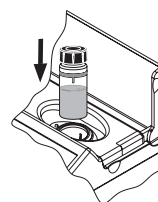

- Press **Zero**. The display will show “-0.0-” when the meter is zeroed and ready for measurement.

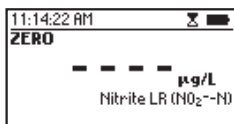
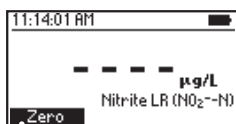

- Remove the cuvette.
- Add one packet of HI93707-0 Nitrite Low Range Reagent.
- Replace the plastic stopper and the cap. Shake gently for about 15 seconds.

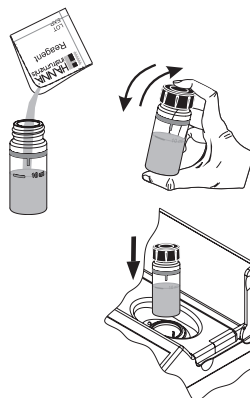

- Insert the cuvette into the holder and close the lid.

- Press **Timer** and the display will show the countdown prior to the measurement or wait 15 minutes and press **Read**. When the timer ends the meter will perform the reading. The instrument displays concentration in $\mu\text{g/L}$ of nitrite-nitrogen (NO_2^--N).

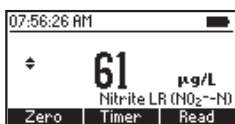
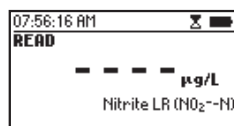
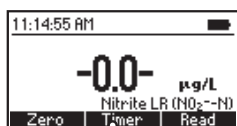

- Press the **▲** or **▼** key to access the second level functions.
- Press **Chem Frm** to convert the result to $\mu\text{g/L}$ of nitrite (NO_2^-) and sodium nitrite (NaNO_2).

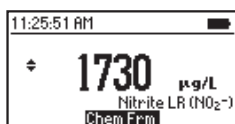
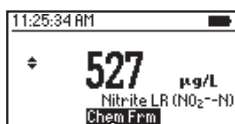

- Press the **▲** or **▼** key to return to the measurement screen.

INTERFERENCES

Interference may be caused by:

- Antimonious, Auric, Bismuth, Chloroplatinate ions, Cupric, Iron (Ferric), Iron (Ferrous), Lead, Mercurous, Silver, Strong reducing or oxidating agents
- Nitrate above 100 mg/L could yield falsely high readings

10.56. Nitrite Low Range (16 mm Vial)

SPECIFICATIONS

Range	0 to 600 $\mu\text{g/L}$ (as NO_2^- -N)
Resolution	1 $\mu\text{g/L}$
Accuracy	$\pm 10 \mu\text{g/L} \pm 3\%$ of reading at 25 °C
Light Source	LED with narrow band interference filter @ 525 nm
Method	Adaptation of the Standard Method for the Examination of Water and Wastewater, 23 rd Edition, 4500B Diazotization Method, Nitrogen Nitrite

REQUIRED REAGENTS

Code	Description	Quantity
HI96783V-0*	Nitrite Low Range Reagent Vial	1 vial
HI96783-0	Nitrite Low Range Reagent for Vial	1 packet

*Reagent vial identification: NO_2LR , green label

REAGENTS SETS

HI96783-25 Reagent for 25 tests

For other accessories see the Accessories section.

Note: Store the unused vials in their packaging in a cool and dark place.

PRINCIPLE

Nitrite is determined through formation of a reddish purple azo dye produced in acidic solution by coupling diazotized sulfanilamide with aromatic amines.

APPLICATION

Wastewater, drinking water, surface water, mineral water, groundwater

SIGNIFICANCE & USE

Nitrite is an intermediate oxidation state of nitrogen, both in the oxidation of ammonia to nitrate and in the reduction of nitrate. Such oxidation and reduction may occur in wastewater treatment plants, water distribution systems and natural waters. Nitrite can enter a water supply system through its use as a corrosion inhibitor in industrial process water. Nitrite changes the normal form of hemoglobin, which carries oxygen through blood to the rest of the body, into a form called methemoglobin that cannot carry oxygen.

MEASUREMENT PROCEDURE

- Select the **Nitrite LR (16)** method using the procedure described in the Method Selection section.
- Insert the 16 mm vial adapter using the procedure described in the Using the 16 mm Vial Adapter section.

- Remove the cap from a **HI96783V-0** Nitrite Low Range Reagent Vial.

- Add 4 mL of sample to the vial, while keeping the vial at a 45-degree angle.

- Replace the cap and invert several times to mix. This is the blank.

- Insert the vial into the holder.

- Press **Zero**. The display will show "-0.0-" when the meter is zeroed and ready for measurement.

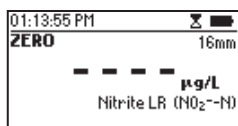
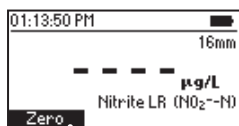

- Remove the vial.
- Remove the cap and add one packet of **HI96783-0** Nitrite Low Range Reagent for Vial.
- Replace the cap and invert for 30 seconds to mix.

- Insert the vial into the holder.

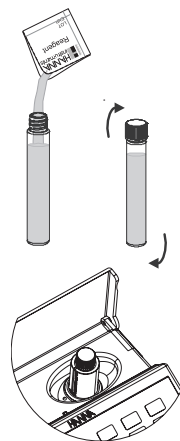
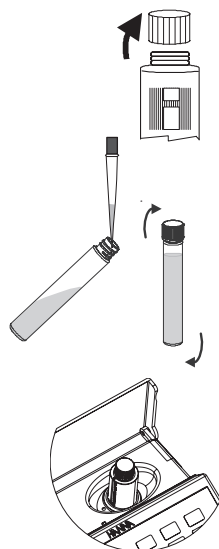

- Press **Timer** and the display will show the countdown prior to the measurement or wait 10 minutes and press **Read**. The instrument displays the result in $\mu\text{g/L}$ of nitrite-nitrogen (NO_2^--N).

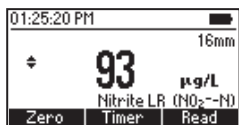
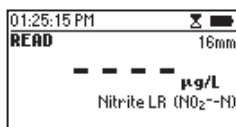
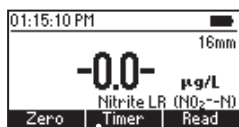

- Press the **▲** or **▼** key to access the second level functions.
- Press **Chem Frm** to convert the result to $\mu\text{g/L}$ of nitrite (NO_2^-) and sodium nitrite (NaNO_2).

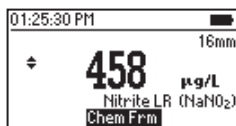
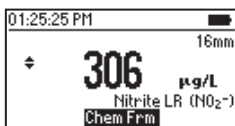
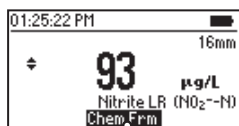

- Press the **▲** or **▼** key to return to the measurement screen.

INTERFERENCES

The pH of the sample must be between 2.0 and 3.0 after the addition of the reagents.

Interference may be caused by:

- Chlorine, Sodium, Sulfate above 2000 mg/L
- Ammonium, Calcium, Nitrate, Phosphate, Potassium above 1000 mg/L
- Magnesium above 500 mg/L
- Copper above 100 mg/L
- Manganese, Zinc above 25 mg/L
- Nickel above 10 mg/L
- Iron above 5 mg/L

10.57. Nitrite Medium Range (16 mm Vial)

SPECIFICATIONS

Range	0.00 to 6.00 mg/L (as NO_2^- -N)
Resolution	0.01 mg/L
Accuracy	± 0.10 mg/L $\pm 3\%$ of reading at 25 °C
Light Source	LED with narrow band interference filter @ 525 nm
Method	Adaptation of the Standard Method for the Examination of Water and Wastewater, 23 rd Edition, 4500B Diazotization Method, Nitrogen Nitrite

REQUIRED REAGENTS

Code	Description	Quantity
HI96784V-0*	Nitrite Medium Range Reagent Vial	1 vial
HI96784-0	Nitrite Medium Range Reagent for Vial	1 packet

*Reagent vial identification: NO_2MR , white label

REAGENTS SETS

HI96784-25 Reagent for 25 tests

For other accessories see the Accessories section.

Note: Store the unused vials in their packaging in a cool and dark place.

PRINCIPLE

Nitrite is determined through formation of a reddish purple azo dye produced in acidic solution by coupling diazotized sulfanilamide with aromatic amines.

APPLICATION

Wastewater, drinking water, surface water, mineral water, groundwater

SIGNIFICANCE & USE

Nitrite is an intermediate oxidation state of nitrogen, both in the oxidation of ammonia to nitrate and in the reduction of nitrate. Such oxidation and reduction may occur in wastewater treatment plants, water distribution systems and natural waters. Nitrite can enter a water supply system through its use as a corrosion inhibitor in industrial process water. Nitrite changes the normal form of hemoglobin, which carries oxygen through blood to the rest of the body, into a form called methemoglobin that cannot carry oxygen.

MEASUREMENT PROCEDURE

- Select the **Nitrite MR (16)** method using the procedure described in the Method Selection section.
- Insert the 16 mm vial adapter using the procedure described in the Using the 16 mm Vial Adapter section.

- Remove the cap from a **HI96784V-0** Nitrite Medium Range Reagent Vial.



- Add 0.4 mL of sample to the vial, while keeping the vial at a 45-degree angle.
- Replace the cap and invert several times to mix. This is the blank.

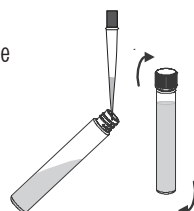

- Insert the vial into the holder.

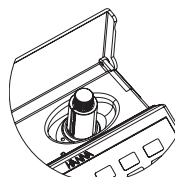

- Press **Zero**. The display will show "-0.0-" when the meter is zeroed and ready for measurement.

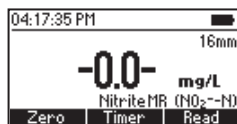
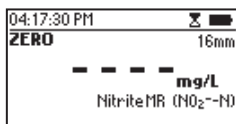
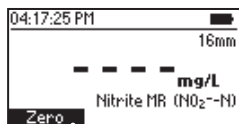

- Remove the vial.
- Remove the cap and add one packet of **HI96784-0** Nitrite Medium Range Reagent for Vial.
- Replace the cap and invert for 30 seconds to mix.

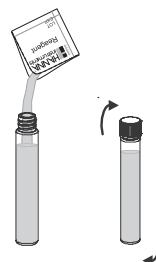

- Insert the vial into the holder.

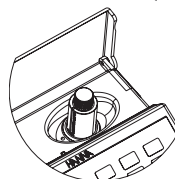

- Press **Timer** and the display will show the countdown prior to the measurement or wait 10 minutes and press **Read**. The instrument displays the result in **mg/L** of **nitrite-nitrogen (NO_2^- -N)**.

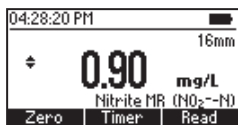
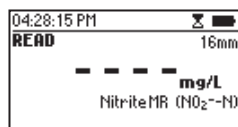
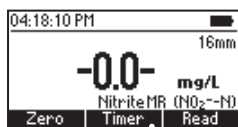

- Press the **▲** or **▼** key to access the second level functions.
- Press **Chem Frm** to convert the result to **mg/L** of **nitrite (NO_2^-)** and **sodium nitrite (NaNO_2)**.

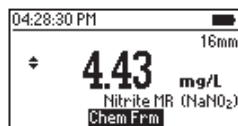
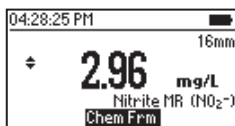
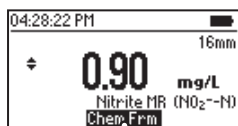

- Press the **▲** or **▼** key to return to the measurement screen.

INTERFERENCES

The pH of the sample must be between 2.0 and 3.0 after the addition of the reagents.

Interference may be caused by:

- Chlorine, Sodium, Sulfate above 4000 mg/L
- Potassium above 3000 mg/L
- Ammonium, Calcium, Nitrate, Phosphate above 2000 mg/L
- Magnesium above 1000 mg/L
- Copper above 200 mg/L
- Manganese, Zinc above 50 mg/L
- Nickel above 20 mg/L
- Iron above 10 mg/L

10.58. Nitrite High Range

SPECIFICATIONS

Range	0 to 150 mg/L (as NO ₂ ⁻)
Resolution	1 mg/L
Accuracy	± 4 mg/L ± 4 % of reading at 25 °C
Light Source	LED with narrow band interference filter @ 575 nm
Method	Adaptation of the Ferrous Sulfate Method

REQUIRED REAGENTS

Code	Description	Quantity
HI93708-0	Nitrite High Range Reagent	1 packet

REAGENT SETS

HI93708-01 Reagents for 100 tests

HI93708-03 Reagents for 300 tests

For other accessories see the Accessories section.

MEASUREMENT PROCEDURE

- Select the **Nitrite HR** method using the procedure described in the Method Selection section.

- Fill the cuvette with 10 mL of unreacted sample (up to the mark).
Replace the plastic stopper and the cap.



- Insert the cuvette into the holder and close the lid.

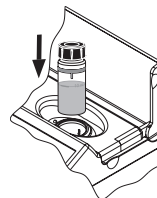

- Press **Zero**. The display will show “-0.0-” when the meter is zeroed and ready for measurement.

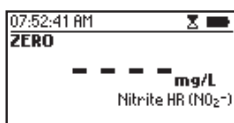
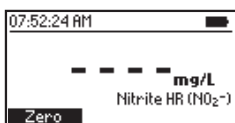

- Remove the cuvette.
- Add one packet of **HI93708-0** Nitrite High Range Reagent. Replace the plastic stopper and the cap. Shake gently until completely dissolved.

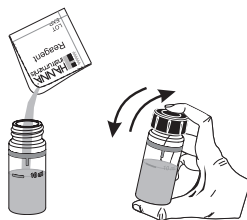

- Insert the cuvette into the holder and close the lid.

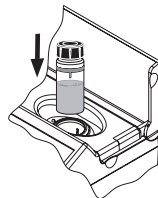

- Press **Timer** and the display will show the countdown prior to the measurement or wait 10 minutes and press **Read**. When the timer ends the meter will perform the reading. The instrument displays concentration in **mg/L** of **nitrite (NO_2^-)**.

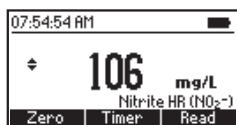
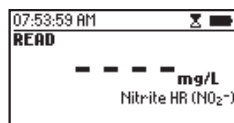
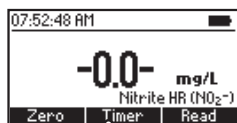

- Press the **▲** or **▼** key to access the second level functions.
- Press **Chem Frm** to convert the result to **mg/L** of **nitrite-nitrogen (NO_2^- -N)** and **sodium nitrite (NaNO_2)**.

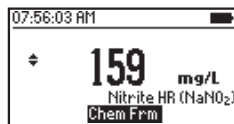
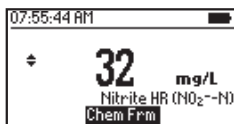
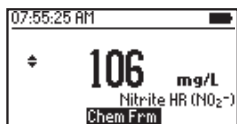

- Press the **▲** or **▼** key to return to the measurement screen.

10.59. Nitrogen, Total Low Range (16 mm Vial)

SPECIFICATIONS

Range	0.0 to 25.0 mg/L (as N)
Resolution	0.1 mg/L
Accuracy	± 1.0 mg/L or $\pm 5\%$ of reading at 25 °C, whichever is greater
Light Source	LED with narrow band interference filter @ 420 nm
Method	Chromotropic Acid Method

REQUIRED REAGENTS

Code	Description	Quantity
HI93767A-B*	Total Nitrogen Low Range Digestion Vial	2 vials
DEIONIZED120	Deionized Water	2 mL
PERSULFATE/N	Potassium Persulfate Reagent	2 packets
BISULFITE/N	Sodium Metabisulfite Reagent	2 packets
HI93767-0	Total Nitrogen Reagent	2 packets
HI93766V-OLR**	Total Nitrogen Low Range Reagent Vial	2 vials

* Reagent vial identification: N LR, green label

** Reagent vial identification: N LR, red label

REAGENT SETS

HI93767A-50 Reagents for up to 49 tests

Box 1: HI93767A-50 Reagent Set

Box 2: HI93767A&B-50 Reagent Set, for Nitrogen Total Low Range

For other accessories see the Accessories section.

Note: Store the unused vials in their packaging in a cool and dark place.

MEASUREMENT PROCEDURE



Before using the reagent kit carefully read all the instructions and the Safety Data Sheets (SDS). Pay particular attention to all warnings, cautions and notes. Failure to do so may result in serious injury to the operator.

Reagent Blank Correction: This method requires a reagent blank correction. A single blank vial may be used more than once, the blank vial is stable for one week if stored in a dark place at room temperature. For improved accuracy use the same lot of reagents for the blank and sample, and run a blank for each set of measurements.

Preheat the Hanna[®] Reactor HI839800 to 105 °C (221 °F). The optional HI740217 safety shield is strongly recommended.

Warning: Do not use an oven or microwave, samples may leak and generate a corrosive and possibly explosive atmosphere.

- Remove the cap from two [HI93767A-B](#) Total Nitrogen Low Range Digestion Vials.

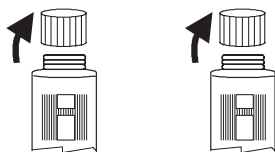

- Add one packet of [PERSULFATE/N](#), Potassium Persulfate to each vial.

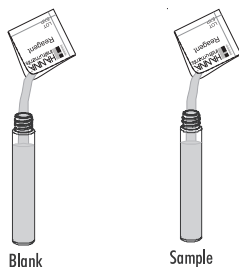

- Add 2 mL of deionized water to the first vial (#1, blank) and 2 mL of sample to the second vial (#2, sample), while keeping the vials at a 45-degree angle.

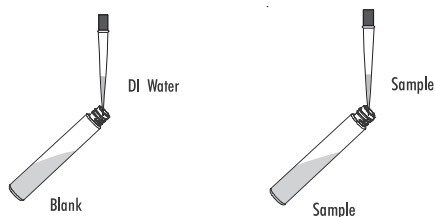

- Replace the cap and shake vigorously for 30 seconds or until powder is completely dissolved.

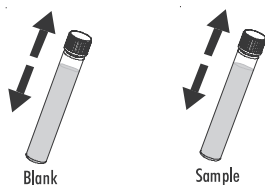

- Insert the vials into the reactor and heat them for 30 minutes at 105 °C (221 °F).



Note: To obtain most accurate results, it is strongly recommended to remove the vials from the reactor after 30 minutes.

- At the end of the digestion period switch off the reactor, place the vials in the test tube rack and allow to cool to room temperature.

Warning: *The vials are still hot, use caution when handling.*



- Select **Nitrogen Total LR (16)** method using the procedure described in the Method Selection section.
- Insert 16 mm vial adapter using the procedure described in the Using the 16 mm Vial Adapter section.
- For this method the instrument provides 3 reaction timers which can be used throughout the procedure.
- Remove the cap from the vials and add one packet of **BISULFITE/N** Sodium Metabisulfite analysis to each vial. Replace the cap and shake gently for 15 seconds.

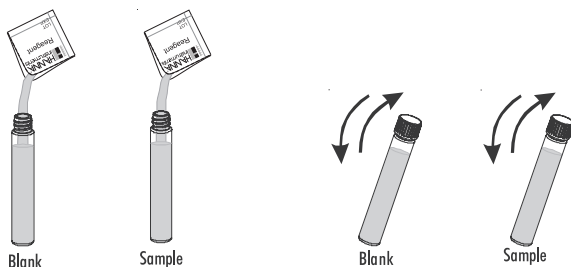

- Press **Timer** and the display will show the countdown prior to adding **HI93767-0** Total Nitrogen Reagent or wait 3 minutes.

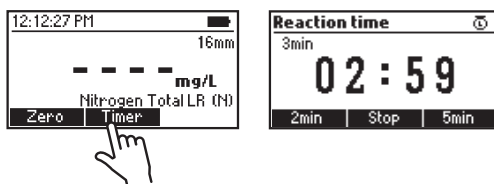

- Remove the cap from the vials and add one packet of **HI93767-0** Total Nitrogen Reagent to each vial. Replace the cap and shake gently for 15 seconds.

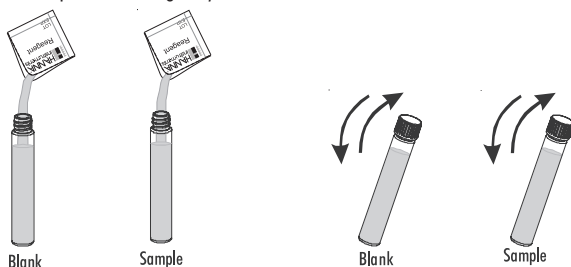

- Press **Continue** and the display will show the countdown or wait 2 minutes (without shaking the vials) to allow the reaction to complete.

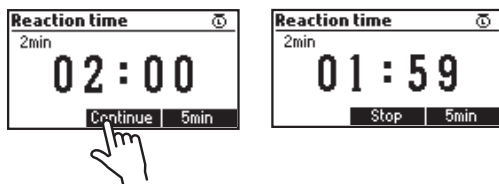

- Remove the cap from two [HI93766V-OLR](#) Total Nitrogen Low Range Reagent Vial.



- Add 2 mL of digested blank (#1) to one of the reagent vials and 2 mL of digested sample (#2) to the second reagent vial, while keeping the vials at a 45-degree angle.
- Replace the cap and invert 10 times.

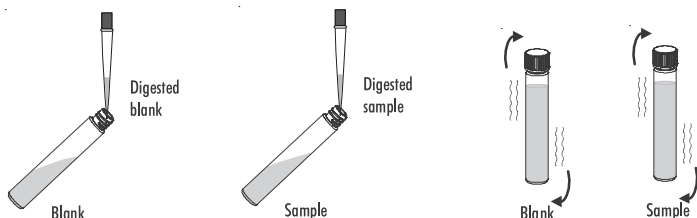

Warning: The vials will become hot during mixing, use caution when handling.

Note: The method is technique sensitive. See procedure described in the *Cuvette Preparation* section for proper mixing technique.

- Place the blank vial (#1) into the vial adapter.

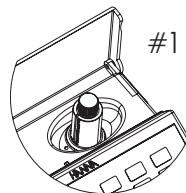

- Press **Continue** and the display will show the countdown or wait 5 minutes.

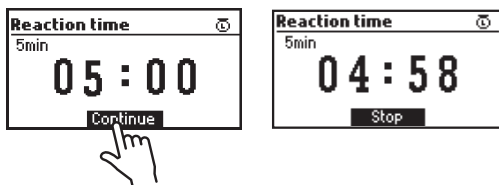

- Press **Zero**. The display will show "-0.0-" when the meter is zeroed and ready for measurement.

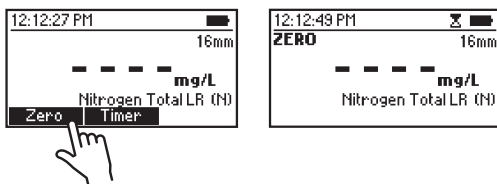

- Remove the blank vial.
- Place the sample vial (#2) into the vial adapter.

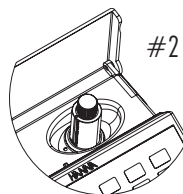

- Press **Read** to start the reading. The instrument displays the results in mg/L of nitrogen (N).

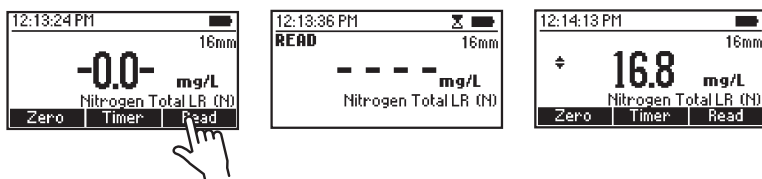

- Press the ▲ or ▼ key to access the second level functions.
- Press **Chem Frm** to convert the result to mg/L of ammonia (NH₃) and nitrate (NO₃⁻).

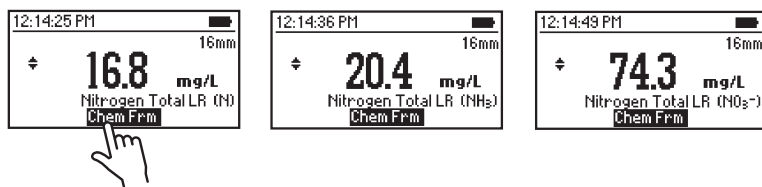

- Press the ▲ or ▼ key to return to the measurement screen.

INTERFERENCES

Interference may be caused by:

- Chloride above 1000 mg/L
- Bromide above 60 mg/L
- Chromium above 0.5 mg/L

10.60. Nitrogen, Total High Range (16 mm Vial)

SPECIFICATIONS

Range	0 to 150 mg/L (as N)
Resolution	1 mg/L
Accuracy	± 3 mg/L or ± 4 % of reading at 25 °C, whichever is greater
Light Source	LED with narrow band interference filter @ 420 nm
Method	Chromotropic Acid Method

REQUIRED REAGENTS

Code	Description	Quantity
HI93767B-B*	Total Nitrogen High Range Digestion Vial	2 vials
DEIONIZED120	Deionized Water	0.5 mL
PERSULFATE/N	Potassium Persulfate Reagent	2 packets
BISULFITE/N	Sodium Metabisulfite Reagent	2 packets
HI93767-0	Total Nitrogen Reagent	2 packets
HI93766V-OHR**	Total Nitrogen High Range Reagent Vial	2 vials

* Reagent vial identification: N HR, red label

** Reagent vial identification: N HR, green label

REAGENT SETS

HI93767B-50 Reagents for up to 49 tests

Box 1: HI93767B-50 Reagent Set

Box 2: HI93767A&B-50 Reagent Set, for Nitrogen Total High Range

For other accessories see the Accessories section.

Note: Store the unused vials in their packaging in a cool and dark place.

MEASUREMENT PROCEDURE



Before using the reagent kit carefully read all the instructions and the Safety Data Sheets (SDS). Pay particular attention to all warnings, cautions and notes. Failure to do so may result in serious injury to the operator.

Reagent Blank Correction: This method requires a reagent blank correction. A single blank vial may be used more than once, the blank vial is stable for one week if stored in a dark place at room temperature. For improved accuracy always use the same lot of reagents for the blank and sample, and run a blank for each set of measurements.

Preheat the Hanna® Reactor HI839800 to 105 °C (221 °F). The optional HI740217 safety shield is strongly recommended.

Warning: Do not use an oven or microwave, samples may leak and generate a corrosive and possibly explosive atmosphere.

- Remove the cap from two HI93767B-B Total Nitrogen High Range Digestion Vials.

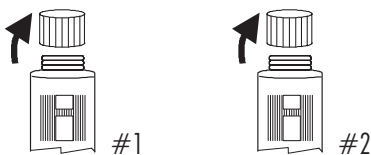

- Add one packet of PERSULFATE/N, Potassium Persulfate to each vial.

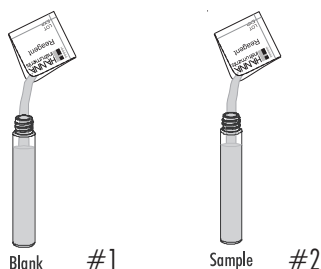

- Add 0.5 mL of deionized water to the first vial (#1, blank) and 0.5 mL of sample to the second vial (#2, sample), while keeping the vials at a 45-degree angle.

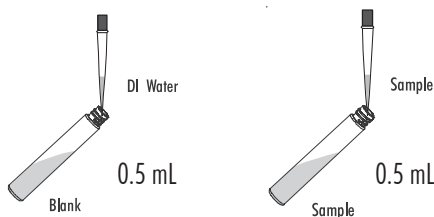

- Replace the caps and shake vigorously for about 30 seconds or until powder is completely dissolved.

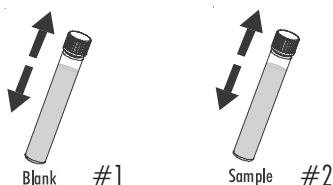

- Insert the vials into the reactor and heat them for 30 minutes at 105 °C (221 °F).



Note: To obtain most accurate results, it is strongly recommended to remove the vials from the reactor after 30 minutes.

- At the end of the digestion place the vials in the test tube rack and allow to cool to room temperature.

Warning: *The vials are still hot, use caution when handling.*



- Select **Nitrogen Total HR (16)** method using the procedure described in the Method Selection section.
- Insert the 16 mm vial adapter using the procedure described in the Using the 16 mm Vial Adapter section.
- For this method the instrument provides 3 reaction timers which can be used throughout the procedure.
- Remove the caps from the vials and add one packet of **BISULFITE/N**, Sodium Metabisulfite to each vial. Replace the caps and shake gently for 15 seconds.

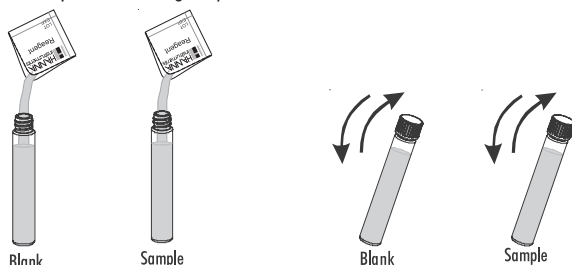

- Press **Timer** and the display will show the countdown prior to adding **HI93767-0** Total Nitrogen Reagent or wait 3 minutes.

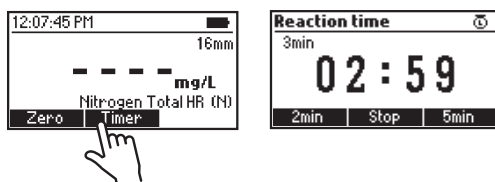

- Remove the caps from the vials and add one packet of **HI93767-0** Total Nitrogen Reagent to each vial. Replace the caps and shake gently for 15 seconds.

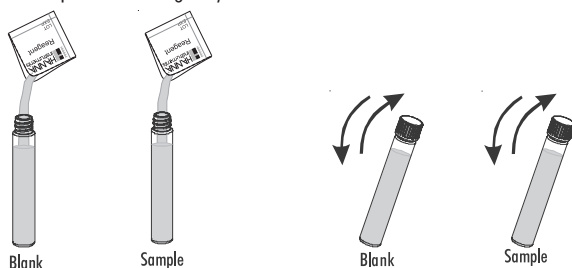

- Press **Continue** and the display will show the countdown or wait 2 minutes.

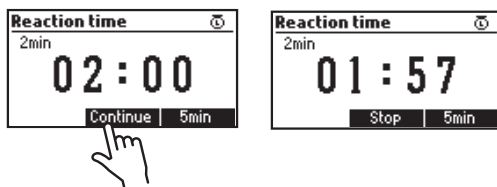

- Remove the cap from two **HI93766V-OHR** Total Nitrogen High Range Regent Vials.

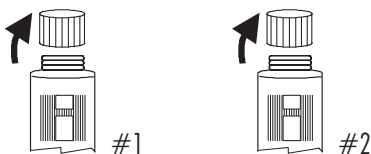

- Add 2 mL of digested blank (#1) to one of the reagent vials and 2 mL of digested sample (#2) to the second reagent vial, while keeping the vials at a 45-degree angle.

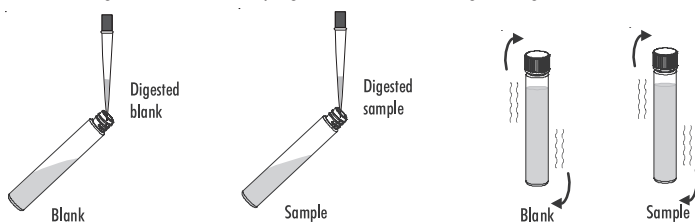

- Replace the caps tightly and invert the vials 10 times.

Warning: The vials will become hot during mixing, use caution when handling.

Note: The method is technique sensitive, see procedure described in the *Cuvette Preparation* section for proper mixing technique.

- Insert the blank vial (#1) into the holder.

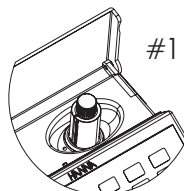

- Press **Continue** and the display will show the countdown or wait 5 minutes.

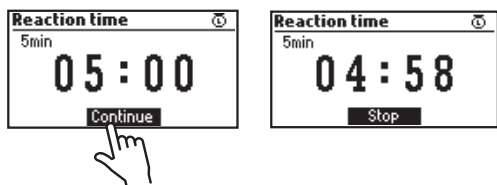

- Press **Zero**. The display will show “-0.0-”.

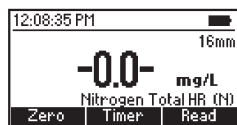
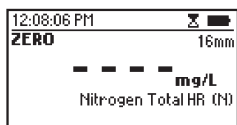
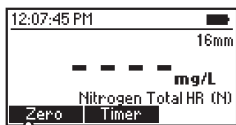

- Remove the blank vial.
- Insert the sample vial (#2) into the holder.

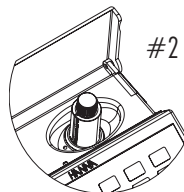

- Press **Read** to start the reading. The instrument displays the results in **mg/L nitrogen (N)**.

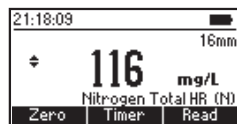
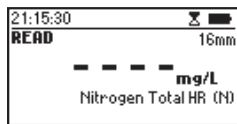
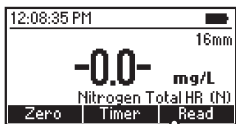

- Press the **▲** or **▼** key to access the second level functions.
- Press **Chem Frm** to convert the result to **mg/L of ammonia (NH₃) and nitrate (NO₃⁻)**.

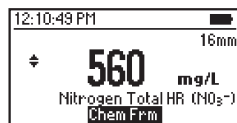
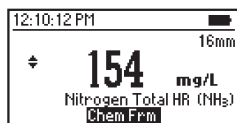
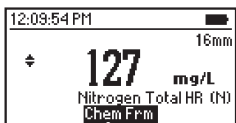

- Press the **▲** or **▼** key to return to the measurement screen.

Note: This method detects all organic and inorganic forms of nitrogen present in the sample.

INTERFERENCES

Interference may be caused by:

- Chloride above 3000 mg/L
- Bromide above 240 mg/L
- Chromium above 0.5 mg/L

10.61. Oxygen, Dissolved

SPECIFICATIONS

Range	0.0 to 10.0 mg/L (as O ₂)
Resolution	0.1 mg/L
Accuracy	±0.4 mg/L ±3 % of reading at 25 °C
Light Source	LED with narrow band interference filter @ 420 nm
Method	Adaptation of Standard Methods for the Examination of Water and Wastewater, 18 th Edition, Azide Modified Winkler Method

REQUIRED REAGENTS

Code	Description	Quantity
HI93732A-0	Dissolved Oxygen Reagent A	5 drops
HI93732B-0	Dissolved Oxygen Reagent B	5 drops
HI93732C-0	Dissolved Oxygen Reagent C	10 drops

REAGENT SET

HI93732-01 Reagents for 100 tests

HI93732-03 Reagents for 300 tests

For other accessories see the Accessories section.

MEASUREMENT PROCEDURE

- Select the **Oxygen (dissolved)** method using the procedure described in the Method Selection section.

- Fill one 60 mL glass bottle completely with the unreacted sample.



- Replace the cap and ensure that a small part of the sample spills over.

- Remove the cap and add 5 drops of HI93732A-0 and 5 drops of HI93732B-0.

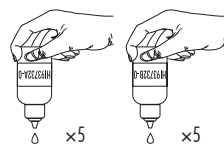

- Add more sample to fill the bottle completely. Replace the cap and ensure that a part of the sample spills over.

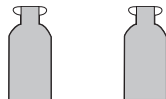

Note: This ensures no air bubbles have been trapped inside the bottle. Trapped air bubbles could alter readings.

- Invert the bottle several times until the sample turns orange-yellow and a flocculating agent appears.

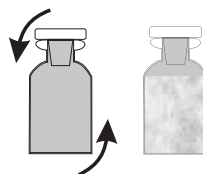

- Let the sample stand for approximately 2 minutes to allow flocculating agent to settle.
- When the upper half of the bottle is clear, add 10 drops of HI93732C-0 Dissolved Oxygen Reagent C.



- Replace the cap and invert the bottle until the settled flocculating agent dissolves completely. The sample is ready for measurement when it is yellow and completely clear.

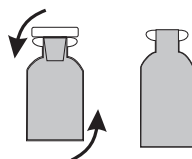

- Fill the first cuvette (#1) with 10 mL of the unreacted sample (up to the mark). Replace the plastic stopper and the cap.



- Insert the cuvette into the holder and close the lid.

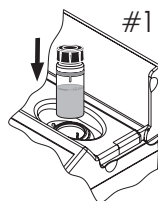

- Press **Zero**. The display will show “-0.0-” when the meter is zeroed and ready for measurement.

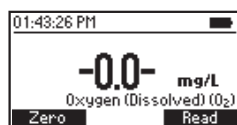
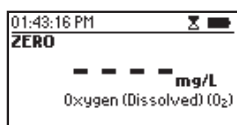
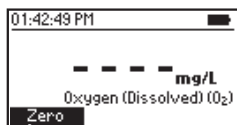

- Remove the cuvette.
- Fill second cuvette (#2) with 10 mL of the reacted sample (up to the mark). Replace the plastic stopper and the cap.



- Insert the cuvette into the holder and close the lid.

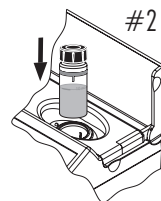

- Press **Read** to start the reading. The instrument will display the results in **mg/L of oxygen (O₂)**.

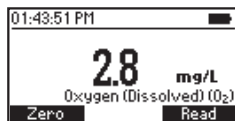
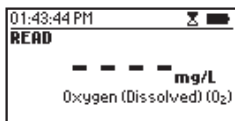
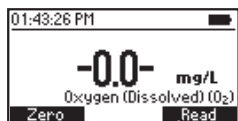

INTERFERENCES

Interference may be caused by:

- Reducing and oxidizing materials

10.62. Oxygen Scavengers (Carbohydrazide)

SPECIFICATIONS

Range	0.00 to 1.50 mg/L (as Carbohydrazide)
Resolution	0.01 mg/L
Accuracy	± 0.02 mg/L ± 3 % of reading at 25 °C
Light Source	LED with narrow band interference filter @ 575 nm
Method	Adaptation of the Iron Reduction Method

REQUIRED REAGENTS

Code	Description	Quantity
HI96773A-0	Oxygen Scavengers Reagent A	2 packets
HI96773B-0	Oxygen Scavengers Reagent B	1 mL

REAGENT SET

HI96773-01	Reagents for 50 tests
HI96773-03	Reagents for 150 tests

For other accessories see the Accessories section.

MEASUREMENT PROCEDURE

- Select the **Oxy. Scavengers (Carbohy)** method using the procedure described in the Method Selection section.

- Fill first cuvette (#1) with 10 mL of deionized water (up to the mark).



- Fill second cuvette (#2) with 10 mL of sample (up to the mark).



- Add one packet of **HI96773A-0** Oxygen Scavengers Reagent A to cuvette #1. Replace the plastic stopper and the cap. Invert for 30 seconds.

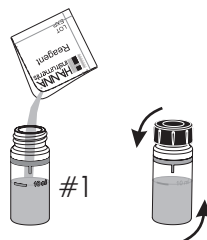

- Add one packet of **HI96773A-0** Oxygen Scavengers Reagent A to cuvette #2. Replace the plastic stopper and the cap. Invert for 30 seconds.

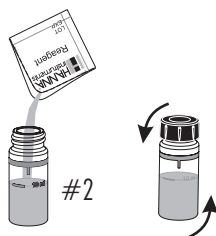

- Add 0.5 mL of **HI96773B-0** Oxygen Scavengers Reagent B to each cuvette using the 1 mL syringe.

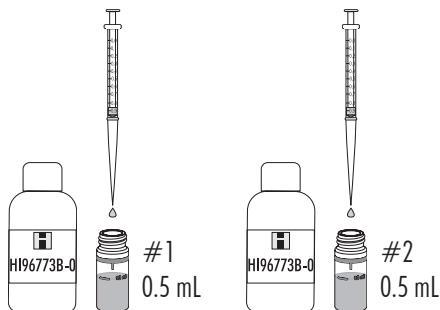

- Replace the plastic stoppers and the caps. Invert for 10 seconds.



- Insert the first cuvette (#1) into the holder and close the lid.

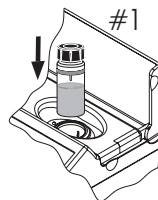

- Press **Timer** and the display will show countdown prior to the measurement or wait 10 minutes and press **Zero**. The display will show “-0.0-” when the meter is zeroed and ready for measurement.

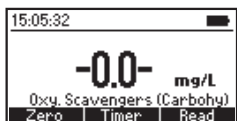
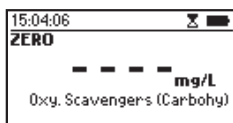
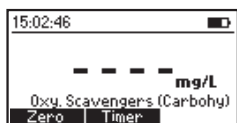

- Remove the cuvette.
- Insert the second cuvette (#2) into the holder and close the lid.

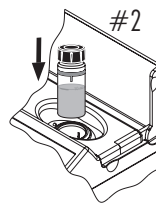

- Press **Read** to start reading. The instrument displays the results in mg/L of carbohydrazide.

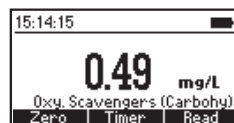
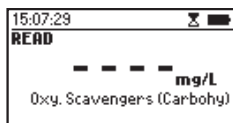
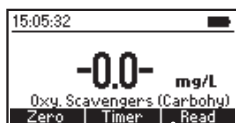

INTERFERENCES

Interference may be caused by:

- Borate (as $\text{Na}_2\text{B}_4\text{O}_7$), Cobalt, Copper, Iron (Ferrous), Hardness (as CaCO_3), Light, Lignosulfonates, Manganese, Molybdenum, Nickel, Phosphate, Phosphonates, Sulfate, Temperature and Zinc

10.63. Oxygen Scavengers (Diethylhydroxylamine) (DEHA)

SPECIFICATIONS

Range	0 to 1000 $\mu\text{g/L}$ (as DEHA)
Resolution	1 $\mu\text{g/L}$
Accuracy	$\pm 5 \mu\text{g/L} \pm 5\%$ of reading at 25 °C
Light Source	LED with narrow band interference filter @ 575 nm
Method	Adaptation of the Iron Reduction Method

REQUIRED REAGENTS

Code	Description	Quantity
HI96773A-0	Oxygen Scavengers Reagent A	2 packets
HI96773B-0	Oxygen Scavengers Reagent B	1 mL

REAGENT SET

HI96773-01	Reagents for 50 tests
HI96773-03	Reagents for 150 tests

For other accessories see the Accessories section.

MEASUREMENT PROCEDURE

- Select the **Oxy. Scavengers (DEHA)** method using the procedure described in the Method Selection section.

- Fill first cuvette (#1) with 10 mL of deionized water (up to the mark).



- Fill second cuvette (#2) with 10 mL of sample (up to the mark).



- Add one packet of **HI96773A-0** Oxygen Scavengers Reagent A to #1 cuvette. Replace the plastic stopper and the cap. Invert for 30 seconds.

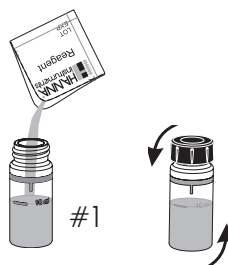

- Add one packet of HI96773A-0 Oxygen Scavengers Reagent A to #2 cuvette. Replace the plastic stopper and the cap. Invert for 30 seconds.

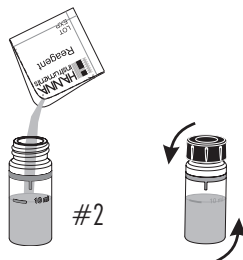

- Add 0.5 mL of HI96773B-0 Oxygen Scavengers Reagent B to each cuvette using the 1 mL syringe.

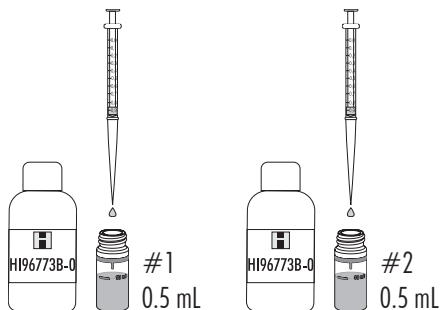

- Replace the plastic stoppers and the caps. Invert for 10 seconds.

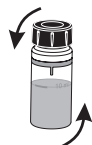

- Insert first cuvette (#1) into the holder and close the lid.

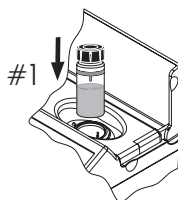

- Press **Timer** and the display will show countdown prior to the measurement or wait 10 minutes and press **Zero**. The display will show “-0.0-” when the meter is zeroed and ready for measurement.

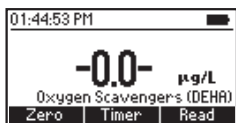
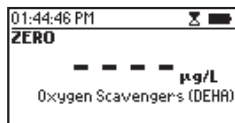
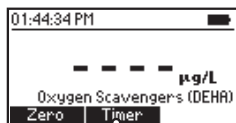

- Remove the cuvette.
- Insert the second cuvette (#2) into the holder and close the lid.

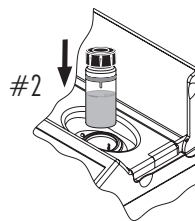

- Press **Read** to start reading. The instrument displays the results in $\mu\text{g/L}$ of DEHA.

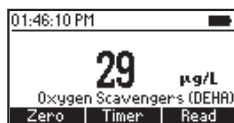
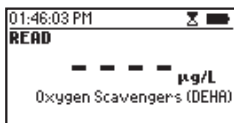
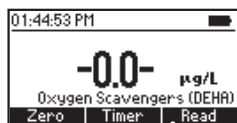

INTERFERENCES

Interference may be caused by:

- Borate (as $\text{Na}_2\text{B}_4\text{O}_7$), Cobalt, Copper, Iron (Ferrous), Hardness (as CaCO_3), Light, Lignosulfonates, Manganese, Molybdenum, Nickel, Phosphate, Phosphonates, Sulfate, Temperature and Zinc

10.64. Oxygen Scavengers (Hydroquinone)

SPECIFICATIONS

Range	0.00 to 2.50 mg/L (as Hydroquinone)
Resolution	0.01 mg/L
Accuracy	± 0.04 mg/L ± 3 % of reading at 25 °C
Light Source	LED with narrow band interference filter @ 575 nm
Method	Adaptation of the Iron Reduction Method

REQUIRED REAGENTS

Code	Description	Quantity
HI96773A-0	Oxygen Scavengers Reagent A	2 packets
HI96773B-0	Oxygen Scavengers Reagent B	1 mL

REAGENT SET

HI96773-01	Reagents for 50 tests
HI96773-03	Reagents for 150 tests

For other accessories see the Accessories section.

MEASUREMENT PROCEDURE

- Select the [Oxy. Scavengers \(Hydro\)](#) method using the procedure described in the Method Selection section.

- Fill first cuvette (#1) with 10 mL of deionized water (up to the mark).



- Fill second cuvette (#2) with 10 mL of sample (up to the mark).



- Add one packet of [HI96773A-0](#) Oxygen Scavengers Reagent A to #1 cuvette. Replace the plastic stopper and the cap. Invert for 30 seconds.

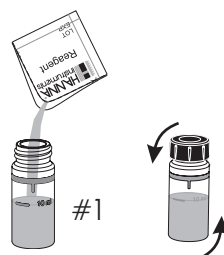

- Add one packet of **HI96773A-0** Oxygen Scavengers Reagent A to #2 cuvette. Replace the plastic stopper and the cap. Invert for 30 seconds.

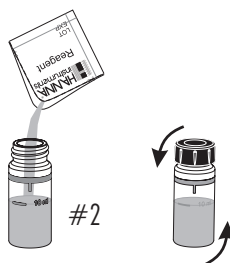

- Add 0.5 mL of **HI96773B-0** Oxygen Scavengers Reagent B to each cuvette using the 1 mL syringe.

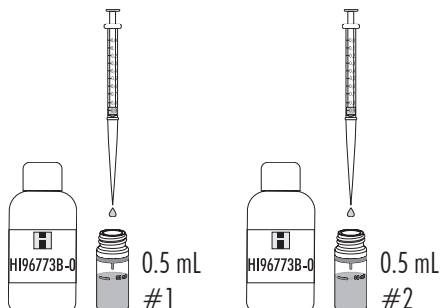

- Replace the plastic stoppers and the caps and invert for 10 seconds.



- Insert first cuvette (#1) into the holder and close the lid.

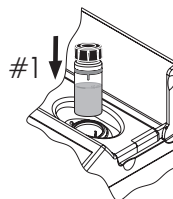

- Press **Timer** and the display will show countdown prior to the measurement or wait 2 minutes and press **Zero**. The display will show “-0.0-” when the meter is zeroed and ready for measurement.

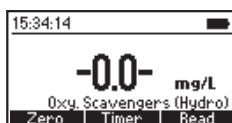
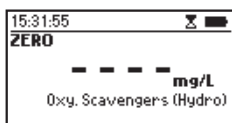
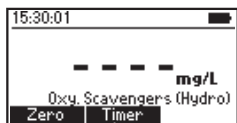

- Remove the cuvette.
- Insert the second cuvette (# 2) into the holder and close the lid.

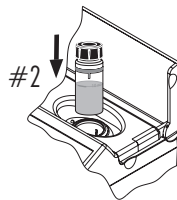

- Press **Read** to start reading. The instrument displays the results in **mg/L of hydroquinone**.

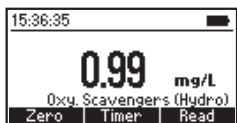
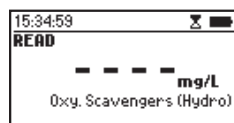
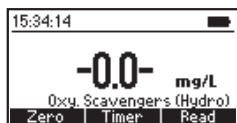

INTERFERENCES

Interference may be caused by:

- Borate (as $\text{Na}_2\text{B}_4\text{O}_7$), Cobalt, Copper, Iron (Ferrous), Hardness (as CaCO_3), Light, Lignosulfonates, Manganese, Molybdenum, Nickel, Phosphate, Phosphonates, Sulfate, Temperature and Zinc

10.65. Oxygen Scavengers (Iso-Ascorbic Acid)

SPECIFICATIONS

Range	0.00 to 4.50 mg/L (as Iso-Ascorbic Acid)
Resolution	0.01 mg/L
Accuracy	± 0.03 mg/L ± 3 % of reading at 25 °C
Light Source	LED with narrow band interference filter @ 575 nm
Method	Adaptation of the Iron Reduction Method

REQUIRED REAGENTS

Code	Description	Quantity
HI96773A-0	Oxygen Scavengers Reagent A	2 packets
HI96773B-0	Oxygen Scavengers Reagent B	1 mL

REAGENT SET

HI96773-01	Reagents for 50 tests
HI96773-03	Reagents for 150 tests

For other accessories see the Accessories section.

MEASUREMENT PROCEDURE

- Select the [Oxygen Scavengers \(ISA\)](#) method using the procedure described in the Method Selection section.

- Fill first cuvette (#1) with 10 mL of deionized water (up to the mark).



- Fill second cuvette (#2) with 10 mL of sample (up to the mark).

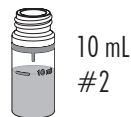

- Add one packet of [HI96773A-0](#) Oxygen Scavengers Reagent A to #1 cuvette. Replace the plastic stopper and the cap. Invert for 30 seconds.

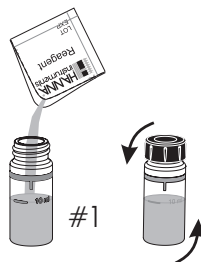

- Add one packet of HI96773A-0 Oxygen Scavengers Reagent A to #2 cuvette. Replace the plastic stopper and the cap. Invert for 30 seconds.

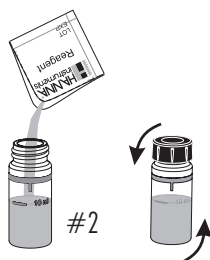

- Add 0.5 mL of HI96773B-0 Oxygen Scavengers Reagent B to each cuvette using the 1 mL syringe.

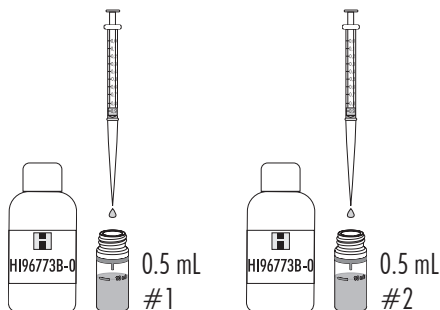

- Replace the plastic stoppers and the caps. Invert for 10 seconds.

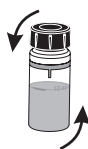

- Insert first cuvette (#1) into the holder and close the lid.

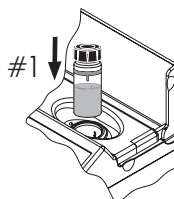

- Press **Timer** and the display will show countdown prior to the measurement or wait 10 minutes and press **Zero**. The display will show “-0.0-” when the meter is zeroed and ready for measurement.

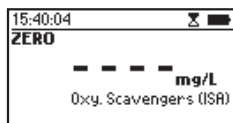
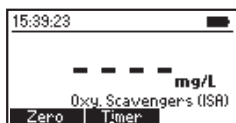

- Remove the cuvette.
- Insert the second cuvette (#2) into the holder and close the lid.

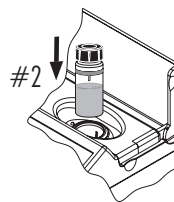

- Press **Read** to start reading. The instrument displays the results in **mg/L** of Iso-ascorbic acid.

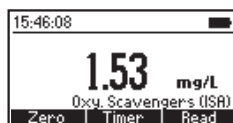
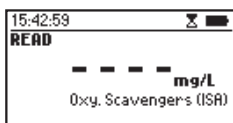
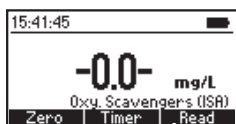

INTERFERENCES

Interference may be caused by:

- Borate (as $\text{Na}_2\text{B}_4\text{O}_7$), Cobalt, Copper, Iron (Ferrous), Hardness (as CaCO_3), Light, Lignosulfonates, Manganese, Molybdenum, Nickel, Phosphate, Phosphonates, Sulfate, Temperature and Zinc

10.66. Ozone

SPECIFICATIONS

Range	0.00 to 2.00 mg/L (as O ₃)
Resolution	0.01 mg/L
Accuracy	±0.02 mg/L ±3 % of reading at 25 °C
Light Source	LED with narrow band interference filter @ 525 nm
Method	Colorimetric DPD Method

REQUIRED REAGENTS

Code	Description	Quantity
HI93757-0	Ozone Reagent	1 packet
HI93703-52-0	Glycine Powder (Optional Reagent)	1 packet

REAGENT SETS

HI93757-01	Reagents for 100 tests
HI93757-03	Reagents for 300 tests
HI93703-52	Reagents for 100 tests (Optional)

For other accessories see the Accessories section.

STANDARD MEASUREMENT PROCEDURE

Chlorine-free samples

- Select the **Ozone** method using the procedure described in the Method Selection section.

- Fill the cuvette with 10 mL of unreacted sample (up to the mark).
Replace the plastic stopper and the cap.

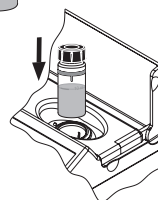

- Insert the cuvette into the holder and close the lid.

- Press **Zero**. The display will show “-0.0-” when the meter is zeroed and ready for measurement.

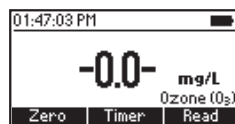
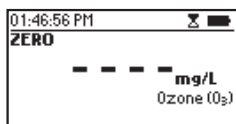
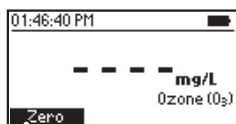

- Remove the cuvette.
- Add one packet of **HI93757-0** Ozone Reagent. Replace the plastic stopper and the cap. Shake gently for 20 seconds.

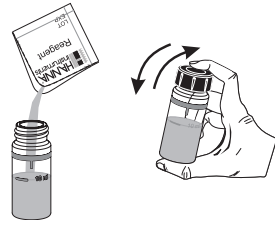

- Insert the cuvette into the holder and close the lid.

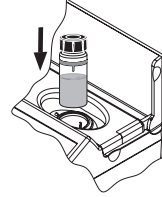

- Press **Timer** and the display will show the countdown prior to the measurement or wait 2 minutes and press **Read**. When the timer ends the meter will perform the reading. The instrument displays the result in **mg/L ozone (O₃)** (chlorine-free sample only). For samples containing chlorine, record this value as A.

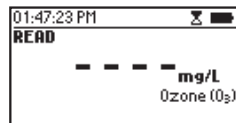

ADDITIONAL MEASUREMENT PROCEDURE

Samples containing chlorine

- Fill the cuvette with 10 mL of unreacted sample (up to the mark).



- Insert the cuvette into the holder and close the lid.

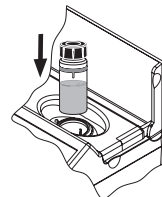

- Press **Zero**. The display will show “-0.0-” when the meter is zeroed and ready for measurement.

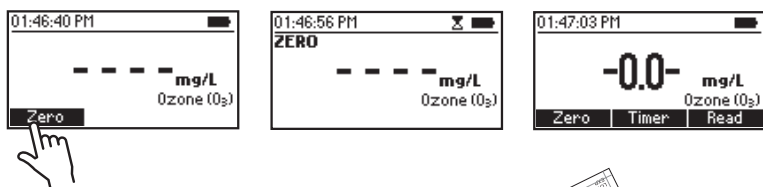

- Remove the cuvette.
- Add one packet of the [HI93703-52-0](#) Glycine Powder. Replace the plastic stopper and the cap. Shake gently until the powder is completely dissolved.

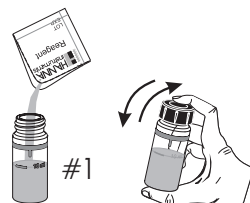

- Add one packet of [HI93757-0](#) Ozone Reagent. Replace the plastic stopper and the cap. Shake gently for 20 seconds.

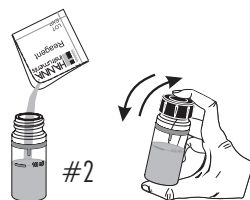

- Insert the cuvette into the holder and close the lid.

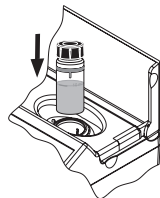

- Press **Timer** and the display will show the countdown prior to the measurement or wait 2 minutes and press **Read**. When the timer ends the meter will perform the reading. Record this value as B.

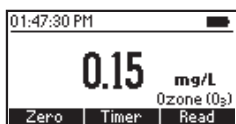

- To determine the **mg/L ozone (O₃)** concentration in sample containing chlorine, subtract value B (additional measurement procedure) from value A (standard measurement procedure).

INTERFERENCES

Interference may be caused by:

- Bromine, Chlorine Dioxide, Iodine
- Hardness greater than 500 mg/L CaCO_3 , shake the sample for approximately 2 minutes after adding the powder reagent
- Alkalinity above 250 mg/L CaCO_3 will not reliably develop the full amount of color or it may rapidly fade, neutralize the sample with diluted HCl.
- If the sample is suspected to contain chlorine residue (free or total chlorine), follow the alternative measurement procedure described below, chlorine is a strong interferent.
 1. Perform the Standard Measurement Procedure. Record the result as Value A.
 2. Perform Additional Measurement Procedure. Record the result as Value B.
 3. To determine the ozone concentration in mg/L, subtract Value B from Value A.
$$\text{mg/L ozone (O}_3\text{)} = \text{Value A} - \text{Value B}$$

10.67. pH

SPECIFICATIONS

Range	6.5 to 8.5 pH
Resolution	0.1 pH
Accuracy	± 0.1 pH at 25 °C
Light Source	LED with narrow band interference filter @ 525 nm
Method	Adaptation of the Phenol Red Method

REQUIRED REAGENTS

Code	Description	Quantity
HI93710-0	pH Reagent	5 drops

REAGENT SETS

HI93710-01 Reagents for 100 tests

HI93710-03 Reagents for 300 tests

For other accessories see the Accessories section.

MEASUREMENT PROCEDURE

- Select the pH method using the procedure described in the Method Selection section.

- Fill the cuvette with 10 mL of unreacted sample (up to the mark).
Replace the plastic stopper and the cap.



- Insert the cuvette into the holder and close the lid.

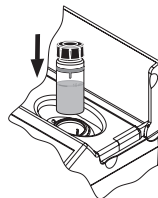

- Press **Zero**. The display will show “-0.0-” when the meter is zeroed and ready for measurement.

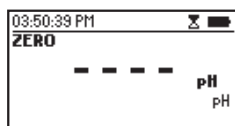
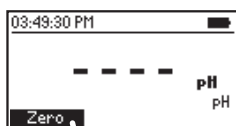

- Remove the cuvette and add 5 drops of **HI93710-0** pH Reagent Indicator. Replace the plastic stopper and the cap and mix the solution.

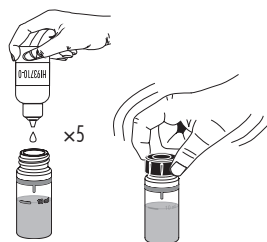

- Insert the cuvette into the holder and close the lid.

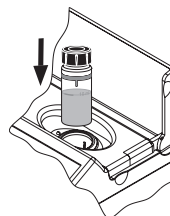

- Press **Read** to start the reading. The instrument displays the result in **pH**.

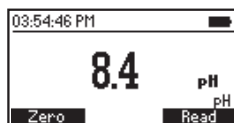
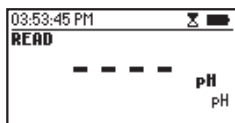

10.68. Phosphate, Marine Ultra Low Range

SPECIFICATIONS

Range	0 to 200 $\mu\text{g/L}$ (as P)
Resolution	1 $\mu\text{g/L}$
Accuracy	$\pm 5 \mu\text{g/L} \pm 5\%$ of reading at 25 °C
Light Source	LED with narrow band interference filter @ 610 nm
Method	Adaptation of Standard Methods for the Examination of Water and Wastewater, 20 th Edition, Ascorbic Acid Method

REQUIRED REAGENTS

Code	Description	Quantity
HI736-0	Phosphorus Ultra Low Range Reagent	1 packet

REAGENT SETS

HI736-25 Reagents for 25 tests
 For other accessories see the Accessories section.

MEASUREMENT PROCEDURE

- Select the **Phosphate Marine ULR** method using the procedure described in the Method Selection section.
- Rinse and replace the plastic stopper and the cap. Shake the cuvette several times with unreacted sample.
- Fill the cuvette with 10 mL of sample (up to the mark). Replace the plastic stopper and the cap.
- Insert the cuvette into the holder and close the lid.
- Press **Zero**. The display will show “-0.0-” when the meter is zeroed and ready for measurement.

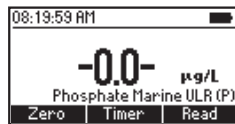
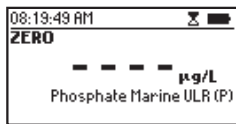
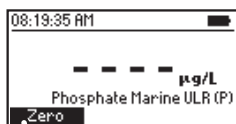
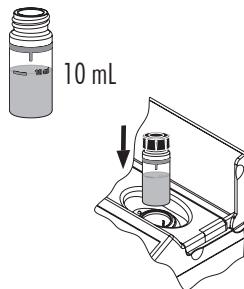

- Add one packet of **HI736-25** Phosphorus Ultra Low Range Reagent. Replace the plastic stopper and the cap. Shake gently (for about 2 minutes) until the powder is completely dissolved.

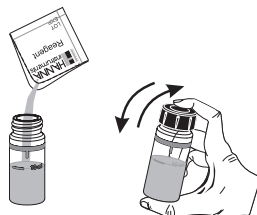

- Insert the cuvette into the holder and close the lid.

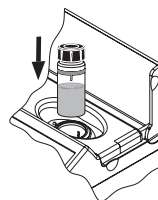

- Press **Timer** and the display will show the countdown prior to the measurement or wait 3 minutes and press **Read**. When the timer ends the meter will perform the reading. The instrument displays concentration in $\mu\text{g/L}$ of phosphorus (P).

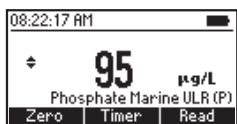
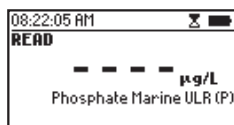
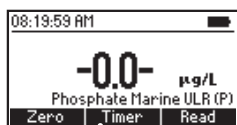

- Press the ▲ or ▼ key to access the second level functions.
- Press **Chem Frm** to convert the result to $\mu\text{g/L}$ of phosphate (PO_4^{3-}) and phosphorus pentoxide (P_2O_5).

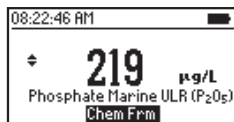
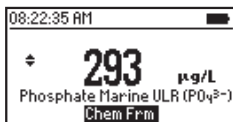
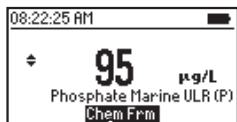

- Press the ▲ or ▼ key to return to the measurement screen.

INTERFERENCES

Interference may be caused by:

- Iron, Silica above 50 mg/L
- Copper, Silicate above 10 mg/L
- Hydrogen sulfide, arsenate, turbid sample and highly buffered samples

10.69. Phosphate Low Range

SPECIFICATIONS

Range	0.00 to 2.50 mg/L (as PO_4^{3-})
Resolution	0.01 mg/L
Accuracy	± 0.04 mg/L $\pm 4\%$ of reading at 25 °C
Light Source	LED with narrow band interference filter @ 610 nm
Method	Adaptation of the Ascorbic Acid Method

REQUIRED REAGENTS

Code	Description	Quantity
HI93713-0	Phosphate Low Range Reagent	1 packet

REAGENT SETS

HI93713-01 Reagents for 100 tests

HI93713-03 Reagents for 300 tests

For other accessories see the Accessories section.

MEASUREMENT PROCEDURE

- Select the **Phosphate LR** method using the procedure described in the Method Selection section.
- Rinse and replace the plastic stopper and the cap. Shake the cuvette several times with unreacted sample.
- Fill the cuvette with 10 mL of sample (up to the mark).
Replace the plastic stopper and the cap.



10 mL

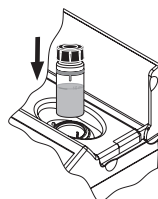

- Insert the cuvette into the holder and close the lid.
- Press **Zero**. The display will show “-0.0-” when the meter is zeroed and ready for measurement.

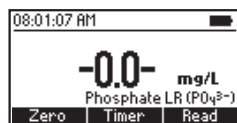
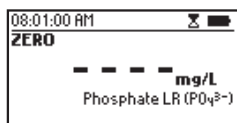
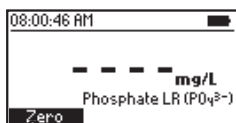

- Remove the cuvette and add the content of one packet of **HI93713-0** Phosphate Low Range Reagent. Replace the plastic stopper and the cap. Shake gently (for about 2 minutes) until the powder is completely dissolved.



- Insert the cuvette into the holder and close the lid.

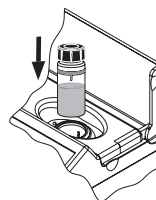

- Press **Timer** and the display will show the countdown prior to the measurement or wait 3 minutes and press **Read**. When the timer ends the meter will perform the reading. The instrument displays concentration in mg/L of phosphate (PO_4^{3-}).

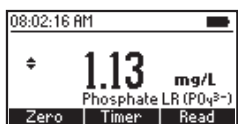
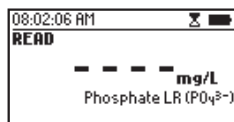
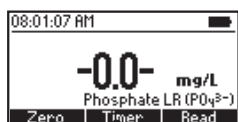

- Press the ▲ or ▼ key to access the second level functions.
- Press **Chem Frm** to convert the result to mg/L of phosphorus (P) and phosphorus pentoxide (P_2O_5).

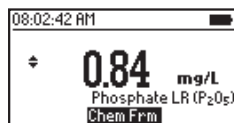
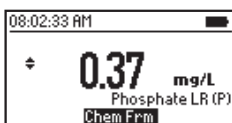
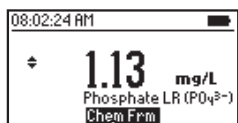

- Press the ▲ or ▼ key to return to the measurement screen.

INTERFERENCES

Interference may be caused by:

- Iron, Silica above 50 mg/L
- Copper, Silicate above 10 mg/L
- Arsenate, Highly buffered samples, Hydrogen sulfide, Turbid samples

10.70. Phosphate High Range

SPECIFICATIONS

Range	0.0 to 30.0 mg/L (as PO_4^{3-})
Resolution	0.1 mg/L
Accuracy	± 1.0 mg/L $\pm 4\%$ of reading at 25 °C
Light Source	LED with narrow band interference filter @ 525 nm
Method	Adaptation of Standard Methods for the Examination of Water and Wastewater, 18 th Edition, Amino Acid Method

REQUIRED REAGENTS

Code	Description	Quantity
HI93717A-0	Phosphate High Range Reagent A	10 drops
HI93717B-0	Phosphate High Range Reagent B	1 packet

REAGENT SETS

HI93717-01 Reagents for 100 tests

HI93717-03 Reagents for 300 tests

For other accessories see the Accessories section.

MEASUREMENT PROCEDURE

- Select the **Phosphate HR** method using the procedure described in the Method Selection section.

- Fill the cuvette with 10 mL of unreacted sample (up to the mark).
Replace the plastic stopper and the cap.



- Insert the cuvette into the holder and close the lid.

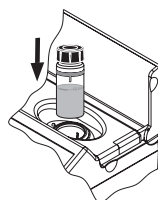

- Press **Zero**. The display will show “-0.0-” when the meter is zeroed and ready for measurement.

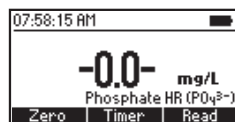
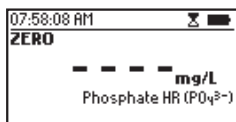
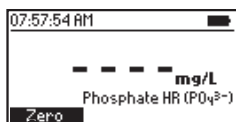

- Add 10 drops of HI93717A-0 Phosphate HR Reagent A.

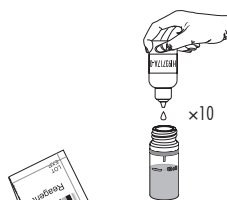

- Add one packet of HI93717B-0 Phosphate HR Reagent B to the cuvette. Replace the plastic stopper and the cap. Shake gently until completely dissolved.

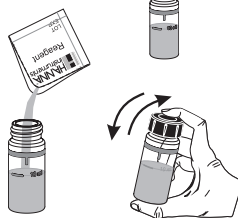

- Insert the cuvette into the holder and close the lid.

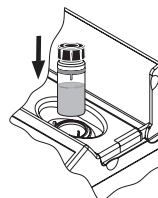

- Press **Timer** and the display will show the countdown prior to the measurement or wait 5 minutes and press **Read**. When the timer ends the meter will perform the reading. The instrument displays the results in mg/L of phosphate (PO_4^{3-}).

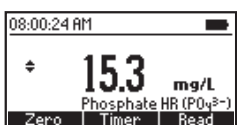
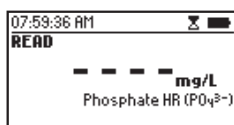
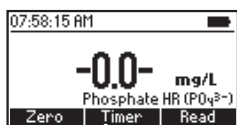

- Press the ▲ or ▼ key to access the second level functions.
- Press **Chem Frm** to convert the result to mg/L of phosphorus (P) and phosphorus pentoxide (P_2O_5).

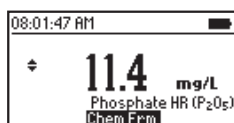
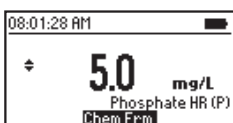
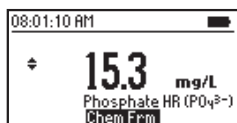

- Press the ▲ or ▼ key to return to the measurement screen.

INTERFERENCES

Interference may be caused by:

- Sulfide
- Chloride above 150000 mg/L
- Magnesium above 40000 mg/L CaCO_3
- Calcium above 10000 mg/L CaCO_3
- Iron (Ferrous) above 100 mg/L

10.71. Phosphorus, Reactive Low Range (16 mm Vial)

SPECIFICATIONS

Range	0.00 to 1.60 mg/L (as P)
Resolution	0.01 mg/L
Accuracy	± 0.05 mg/L or $\pm 4\%$ of reading at 25 °C, whichever is greater
Light Source	LED with narrow band interference filter @ 610 nm
Method	Adaptation of the EPA Method 365.2 & Standard Methods for the Examination of Water and Wastewater, 20 th Edition, 4500-P E, Ascorbic Acid Method

REQUIRED REAGENTS

Code	Description	Quantity
HI93758A-0*	Phosphorus Reactive Reagent Vial	1 vial
HI93758-0	Phosphorus Reagent	1 packet

* Reagent vial identification: P R, red label

REAGENT SETS

HI93758A-50 Reagents for 50 tests

For other accessories see the Accessories section.

Note: Store the unused vials in their packaging in a cool and dark place.

MEASUREMENT PROCEDURE

- Select the **Phosphorus Reactive LR (16)** method using the procedure described in the Method Selection section.
- Insert the 16 mm vial adapter using the procedure described in the Using the 16 mm Vial Adapter section.
- Remove the cap from HI93758A-0 Reactive Phosphorus Reagent Vial.
- Add 5 mL of sample to the vial, while keeping the vial at a 45-degree angle.
- Replace the cap and invert several times to mix.
- Insert the vial into the holder.

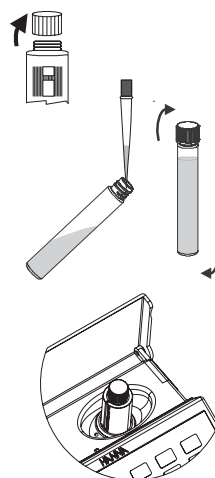

- Press **Zero**. The display will show "-0.0-" when the meter is zeroed and ready for measurement.

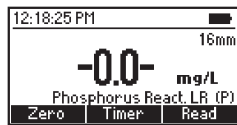
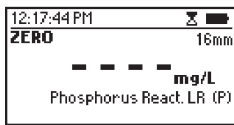
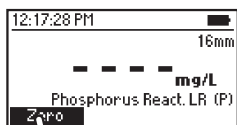

- Remove the vial.
- Remove the cap and add one packet of **HI93758-0** Phosphorus Reagent.
- Replace the cap shake gently for 2 minutes until most of the powder is dissolved.

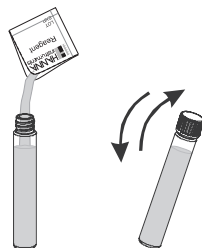

- Insert the vial into the holder.

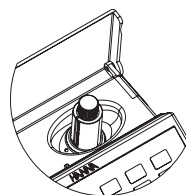

- Press **Timer** and the display will show the countdown prior to the measurement or wait 3 minutes and press **Read**. When the timer ends the meter will perform the reading. The instrument displays the results in **mg/L** of **Phosphorus (P)**.

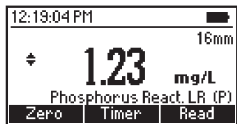
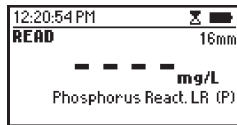
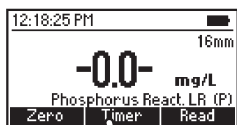

- Press the ▲ or ▼ key to access the second level functions.

- Press **Chem Frm** to convert the result to mg/L of phosphate (PO_4^{3-}) and phosphorus pentoxide (P_2O_5).

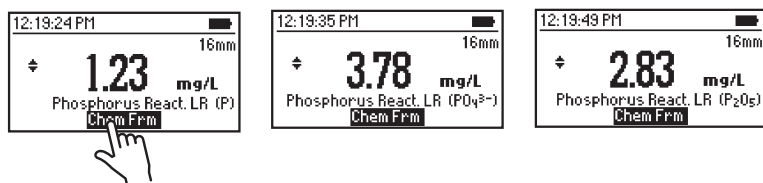

- Press the ▲ or ▼ key to return to the measurement screen.

INTERFERENCES

Interference may be caused by:

- Arsenate must be absent
- Silica above 50 mg/L
- Sulfide above 6 mg/L, to remove interference add Bromine Water drop-wise until a pale yellow color develops, to remove excess bromine water add Phenol Solution drop-wise until the solution is clear
- Turbidity and suspended matter in large amounts, treat the sample with active carbon and filter, before measuring

10.72. Phosphorus, Reactive High Range (16 mm Vial)

SPECIFICATIONS

Range	0.0 to 32.6 mg/L (as P)
Resolution	0.1 mg/L
Accuracy	± 0.5 mg/L or ± 4 % of reading at 25 °C, whichever is greater
Light Source	LED with narrow band interference filter @ 420 nm
Method	Adaptation of Standard Methods for the Examination of Water and Wastewater, 20 th Edition, 4500-P C, Vanadomolybdophosphoric Acid Method

REQUIRED REAGENTS

Code	Description	Quantity
HI93763A-0*	Reactive Phosphorus High Range Reagent Vial	2 vials
Deionized120	Deionized Water	5 mL

*Reagent vial identification: P RHR, green label

REAGENT SETS

HI93763A-50 Reagents for up to 49 tests

For other accessories see the Accessories section.

Note: Store the unused vials in their packaging in a cool and dark place.

MEASUREMENT PROCEDURE

Reagent Blank Correction: This method requires a reagent blank correction. A single blank vial may be used more than once; the blank vial is stable up to two weeks (room temperature). For improved accuracy always use the same lot of reagents for the blank and sample, and run a blank for each set of measurements.

- Select the **Phosphorus Reactive HR (16)** method using the procedure described in the Method Selection section.
- Insert the 16 mm vial adapter using the procedure described in the Using the 16 mm Vial Adapter section.
- Remove the cap from two HI93763A-0 Phosphorus Reactive HR Reagent Vials.

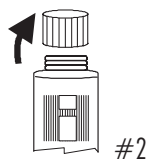
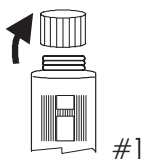

- Add 5 mL of deionized water to the first vial (#1) and 5 mL of sample to the second vial (#2), while keeping the vials at a 45-degree angle. Replace the caps and invert several times to mix.

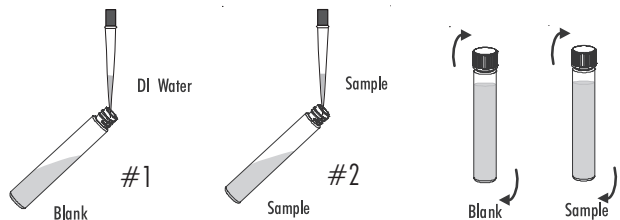

- Insert the blank vial (#1) into the holder and push it completely down.

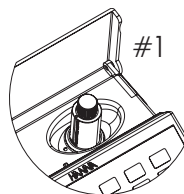

- Press **Timer** and the display will show the countdown prior to the zero reading or wait 7 minutes and press **Zero**. The display will show "-0.0-" when the meter is zeroed and ready for measurement.

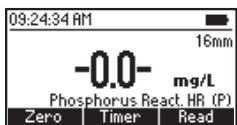
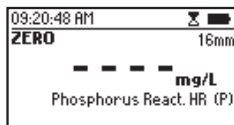
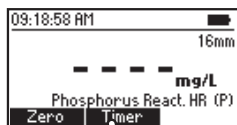

- Remove the blank vial.
- Insert the sample vial (#2) into the holder.

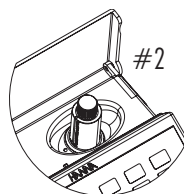

- Press **Read** to start the measurement. The instrument displays the results in mg/L of phosphorus (P).

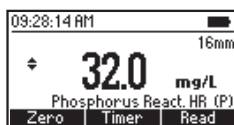
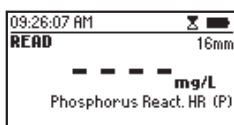
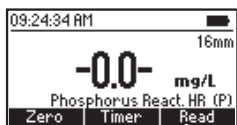

- Press the ▲ or ▼ key to access the second level functions.

- Press Chem Frm to convert the result to mg/L of phosphate (PO_4^{3-}) and phosphorus pentoxide (P_2O_5).

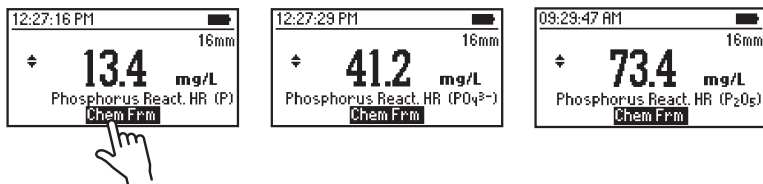

- Press the ▲ or ▼ key to return to the measurement screen.

INTERFERENCES

Interference may be caused by:

- Bismuth, Fluoride
- The sample should have a neutral pH
- Sulfide, to remove the interferent add Bromine Water drop-wise until a pale yellow color develops, remove excess Bromine Water by adding Phenol Solution drop-wise
- The method is temperature sensitive. It is recommended to run measurements between 20 and 25 °C (68 and 77 °F), temperatures below 20 °C (68 °F) cause a negative error, temperatures above 25 °C (77 °F) cause a positive error
- Turbidity and suspended matter in large amounts, treat the sample with active carbon and filter before measuring

10.73. Phosphorus, Acid Hydrolyzable (16 mm Vial)

SPECIFICATIONS

Range	0.00 to 1.60 mg/L (as P)
Resolution	0.01 mg/L
Accuracy	± 0.05 mg/L or $\pm 5\%$ of reading at 25 °C, whichever is greater
Light Source	LED with narrow band interference filter @ 610 nm
Method	Adaptation of the EPA Method 365.2 and Standard Methods for the Examination of Water and Wastewater, 20 th Edition, 4500-P E, Ascorbic Acid Method

REQUIRED REAGENTS

Code	Description	Quantity
HI93758V-0AH*	Phosphorus Reagent Vial	1 vial
HI93758B-0	NaOH Solution 1.20 N	2 mL
HI93758-0	Phosphorous Reagent	1 packet

* Reagent vial identification: P AH, white label

REAGENT SETS

HI93758B-50 Reagents for 50 tests

For other accessories see the Accessories section.

Note: Store the unused vials in their packaging in a cool and dark place.

MEASUREMENT PROCEDURE



Before using the reagent kit carefully read all the instructions and the Safety Data Sheets (SDS). Pay particular attention to all warnings, cautions and notes. Failure to do so may result in serious injury to the operator.

- Preheat the Hanna[®] Reactor HI839800 to 150 °C (302 °F). The optional HI740217 safety shield is strongly recommended.

Warning: Do not use an oven or microwave! Samples may leak and generate a corrosive and possibly explosive atmosphere.

- Remove the cap from a HI93758V-0AH Phosphorus Reagent Vial.
- Add 5 mL of sample to the vial, while keeping the vial at a 45-degree angle.

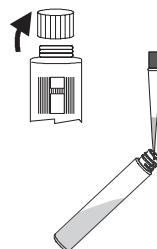

- Replace the cap and invert to mix.

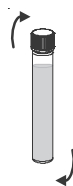

- Insert the vial into the reactor and heat it for 30 minutes at 150 °C (302 °F).



- At the end of the digestion place the vials carefully in the test tube rack and allow to cool to room temperature.

Warning: *The vials are still hot, use caution when handling.*



- Select the **Phosphorus Acid Hydrolyzable (16)** method using the procedure described in the Method Selection section.

- Insert the 16 mm vial adapter using the procedure described in the Using the 16 mm Vial Adapter section.

- Remove the cap from the vial and add 2 mL of **HI93758B-0** NaOH Solution 1.20 N while keeping the vial at a 45-degree angle.

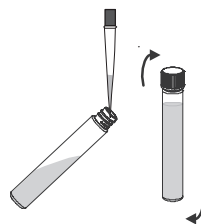

- Replace the cap and invert to mix.

- Insert the vial into the holder.

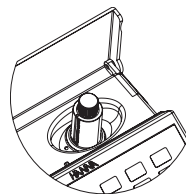

- Press **Zero**. The display will show “-0.0-” when the meter is zeroed and ready for measurement.

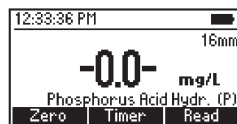
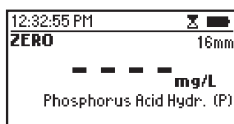
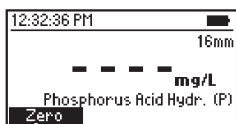

- Remove the vial.
- Remove the cap and add one packet of **HI93758-0** Phosphorus Reagent.



- Replace the cap and shake gently for 2 minutes until most of the powder is dissolved.

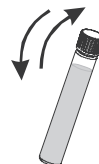

- Insert the vial into the holder.

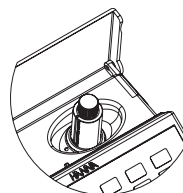

- Press **Timer** and the display will show the countdown prior to the measurement or wait 3 minutes and press **Read**. The instrument displays the results in **mg/L** of **phosphorus (P)**.

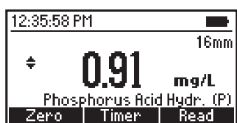
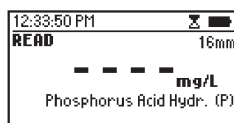
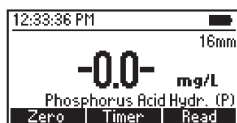

Note: The method detects free (orthophosphate) and condensed inorganic forms (meta-, pyro- and other polyphosphates) of phosphates present in the sample.

- Press the ▲ or ▼ key to access the second level functions.

- Press Chem Frm to convert the result in mg/L of phosphate (PO_4^{3-}) and mg/L phosphorus pentoxide (P_2O_5).

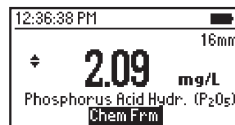
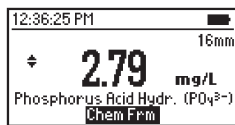
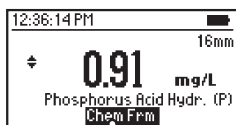

- Press the ▲ or ▼ key to return to the measurement screen.

INTERFERENCES

Interference may be caused by:

- Arsenate must be absent
- Silica above 50 mg/L
- Sulfide, to remove the interferent add Bromine Water drop-wise until a pale yellow color develops, remove excess Bromine Water by adding Phenol Solution drop-wise
- Turbidity and suspended matter in large amounts, treat the sample with active carbon and filter, before measuring

10.74. Phosphorus, Total Low Range (16 mm Vial)

SPECIFICATIONS

Range	0.00 to 1.15 mg/L (as P)
Resolution	0.01 mg/L
Accuracy	± 0.05 mg/L or $\pm 6\%$ of reading at 25 °C, whichever is greater
Light Source	LED with narrow band interference filter @ 610 nm
Method	Adaptation of the EPA Method 365.2 & Standard Methods for the Examination of Water and Wastewater, 20 th Edition, 4500-P E, Ascorbic Acid Method

REQUIRED REAGENTS

Code	Description	Quantity
HI93758V-0*	Phosphorus Reagent Vial	1 vial
HI93758C-0	NaOH Solution 1.54 N	2 mL
HI93758-0	Phosphorous Reagent	1 packet
PERSULFATE/P	Potassium Persulfate	1 packet

* Reagent vial identification: P TLR, red label

REAGENT SETS

HI93758C-50 Reagents for 50 tests

For other accessories see the Accessories section.

Note: Store the unused vials in their packaging in a cool and dark place.

MEASUREMENT PROCEDURE



Before using the reagent kit carefully read all the instructions and the Safety Data Sheets (SDS). Pay particular attention to all warnings, cautions and notes. Failure to do so may result in serious injury to the operator.

- Preheat the Hanna[®] Reactor HI839800 to 150 °C (302 °F). The optional HI740217 safety shield is strongly recommended.

Warning: Do not use an oven or microwave, samples may leak and generate a corrosive and possibly explosive atmosphere.

- Remove the cap from a HI93758V-0 Phosphorus Reagent vial.



- Add 5 mL of sample to the vial, while keeping the vial at a 45-degree angle.

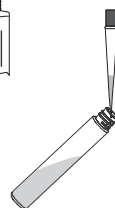

- Add one packet of **PERSULFATE/P** Potassium Persulfate. Replace the cap and shake gently the vial until all the powder is completely dissolved.

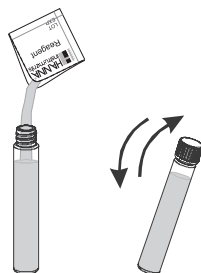

- Insert the vial into the reactor and heat it for 30 minutes at 150 °C (302 °F).



- At the end of the digestion place the vials carefully in the test tube rack and allow to cool to room temperature.

Warning: *the vials are still hot, use caution when handling.*



- Select the **Phosphorus Total LR (16)** method using the procedure described in the Method Selection section.

- Insert the 16 mm vial adapter using the procedure described in the Using the 16 mm Vial Adapter section.

- Remove the cap from the vial and add exactly 2 mL of **HI93758C-0** NaOH Solution 1.54 N, while keeping the vial at a 45-degree angle.

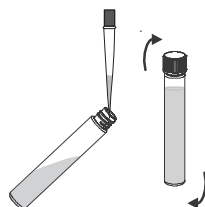

- Replace the cap and invert the vial several times to mix.

- Insert the vial into the holder.

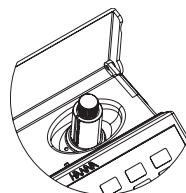

- Press **Zero**. The display will show "-0.0-" when the meter is zeroed and ready for measurement.

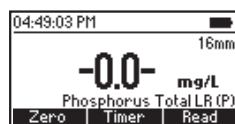
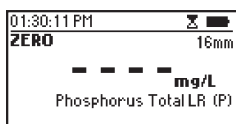
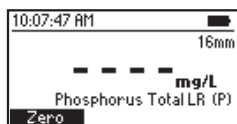

- Remove the vial.
- Remove the cap and add one packet of **HI93758-0** Phosphorus Reagent.



- Replace the cap and shake for 2 minutes until the powder is completely dissolved.



- Insert the vial into the holder.

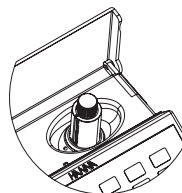

- Press **Timer** and the display will show the countdown prior to the measurement or wait 3 minutes and press **Read**. The instrument displays the results in **mg/L** of **phosphorus (P)**.

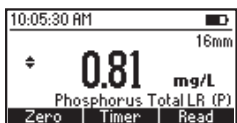
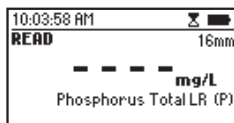
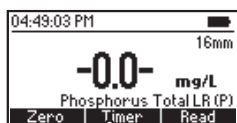

Note: The method detects free (orthophosphate) and condensed inorganic forms (meta-, pyro- and other polyphosphates) of phosphates present in the sample.

- Press the **▲** or **▼** key to access the second level functions.

- Press **Chem Frm** to convert the result to mg/L of phosphate (PO_4^{3-}) and phosphorus pentoxide (P_2O_5).

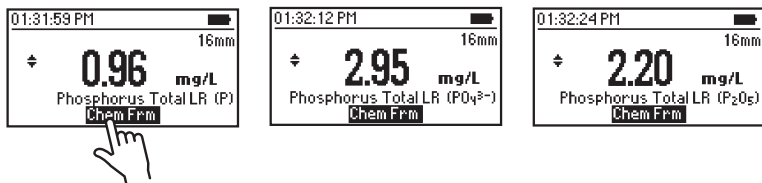

- Press the ▲ or ▼ key to return to the measurement screen.

INTERFERENCES

Interference may be caused by:

- Arsenate must be absent
- Silica above 50 mg/L
- Sulfide, to remove the interferent add Bromine Water drop-wise until a pale yellow color develops, remove excess Bromine Water by adding Phenol Solution drop-wise
- Turbidity and suspended matter in large amounts, treat the sample with active carbon and filter, before measuring

10.75. Phosphorus, Total High Range (16 mm Vial)

SPECIFICATIONS

Range	0.0 to 32.6 mg/L (as P)
Resolution	0.1 mg/L
Accuracy	± 0.5 mg/L or $\pm 5\%$ of reading at 25 °C, whichever is greater
Light Source	LED with narrow band interference filter @ 420 nm
Method	Adaptation of Standard Methods for the Examination of Water and Wastewater, 20 th Edition, 4500-P C, Vanadomolybdophosphoric Acid Method

REQUIRED REAGENTS

Code	Description	Quantity
HI93758V-OHR*	Phosphorus Reagent Vial	2 vials
HI93758C-0	NaOH Solution 1.54 N	4 mL
HI93763B-0	Total Phosphorous High Range Reagent B	1 mL
DEIONIZED120	Deionized Water	5 mL
PERSULFATE/P	Potassium Persulfate	2 packets

*Reagent vial identification: P THR, green label

REAGENT SETS

HI93763B-50 Reagents for up to 49 tests

For other accessories see the Accessories section.

Note: Store the unused vials in their packaging in a cool and dark place.

MEASUREMENT PROCEDURE



Before using the reagent kit carefully read all the instructions and the Safety Data Sheets (SDS). Pay particular attention to all warnings, cautions and notes. Failure to do so may result in serious injury to the operator.

Reagent Blank Correction: This method requires a reagent blank correction. A single blank vial may be used more than once. The blank vial is stable for one day at room temperature.

Preheat the Hanna[®] Reactor HI839800 to 150 °C (302 °F). The optional HI740217 safety shield is strongly recommended.

Warning: Do not use an oven or microwave, samples may leak and generate a corrosive and possibly explosive atmosphere.

- Remove the cap from two HI93758V-OHR Phosphorus Reagent Vials.



- Add 5 mL of deionized water to the first vial (#1) and 5 mL of sample to the second vial (#2), while keeping the vials at a 45-degree angle.

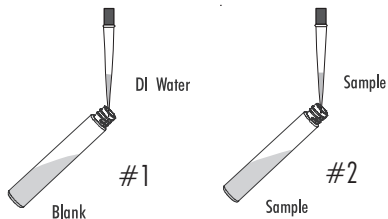

- Add one packet of PERFSULFATE/P Potassium Persulfate to each vial. Replace the caps and shake gently until all the powder is completely dissolved.

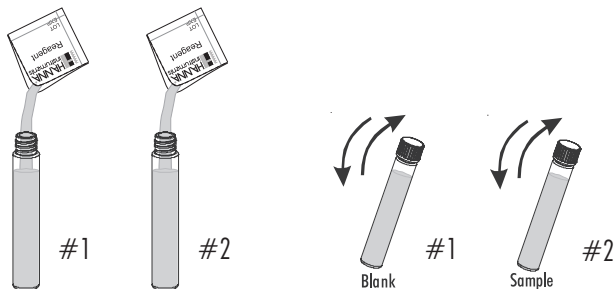

- Insert the vials into the reactor and heat them for 30 minutes at 150 °C (302 °F).



- At the end of the digestion place the vials carefully in the test tube rack and allow to cool to room temperature.

Warning: The vials are still hot, use caution when handling.

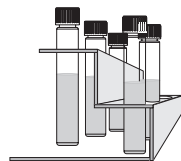

- Select the **Phosphorus Total HR (16)** method using the procedure described in the Method Selection section.
- Insert the 16 mm vial adapter using the procedure described in the Using the 16 mm Vial Adapter section.

- Remove the cap from the vials and add 2 mL of **HI93758C-0** NaOH Solution 1.54 N to each vial, while keeping the vials at a 45-degree angle. Replace the cap tightly and invert the vials several times to mix.
- Remove the cap from the vials and add 0.5 mL of **HI93763B-0** Total Phosphorous HR Reagent B to each vial, while keeping the vial at a 45-degree angle. Replace the cap and invert several times to mix.

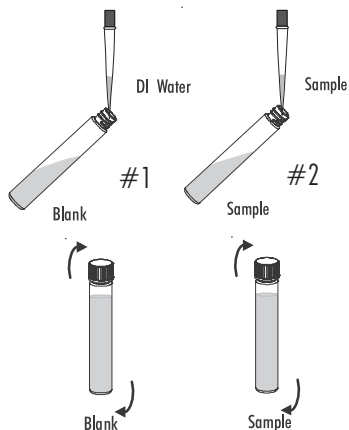

- Insert the blank vial (#1) into the holder.

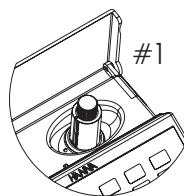

- Press **Timer** and the display will show the countdown prior to the measurement or wait 7 minutes and press **Zero**. The display will show "-0.0-" when the meter is zeroed and ready for measurement.

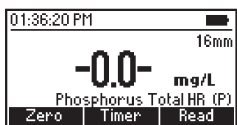
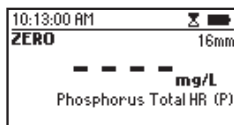
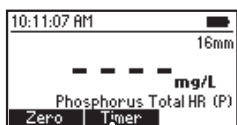

- Remove the blank vial.
- Insert the sample vial (#2) into the holder.
- Press **Read**. The instrument displays the results in **mg/L phosphorus (P)**.

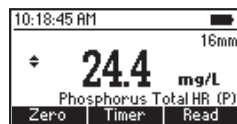
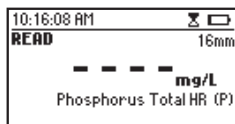
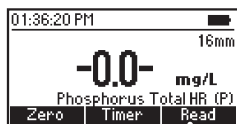
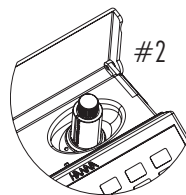

Note: The method detects free (orthophosphate), condensed inorganic forms (meta-, pyro- and other polyphosphates) and organic forms of phosphates present in the sample.

- Press the **▲** or **▼** key to access the second level functions.
- Press **Chem Frm** to convert the result to **mg/L of phosphate (PO_4^{3-})** and **phosphorus pentoxide (P_2O_5)**.

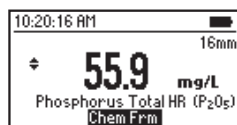
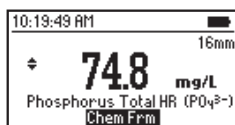
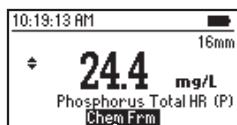

- Press the **▲** or **▼** key to return to the measurement screen.

INTERFERENCES

Interference may be caused by:

- Arsenate
- The sample should have a neutral pH
- The method is temperature sensitive. It is recommended to add the Molybdo vanadate Reagent and to run measurements between 20 and 25 °C (68 and 77 °F), temperatures below 20 °C (68 °F) cause a negative error, temperatures above 25 °C (77 °F) cause a positive error
- Turbidity and suspended matter in large amounts, treat the sample with active carbon and filter before measuring

10.76. Potassium

SPECIFICATIONS

Range	0.0 to 20.0 mg/L (as K)
Resolution	0.1 mg/L
Accuracy	± 3.0 mg/L ± 7 % of reading at 25 °C
Light Source	LED with narrow band interference filter @ 466 nm
Method	Adaptation of the Turbidimetric Tetraphenylborate Method

REQUIRED REAGENTS

Code	Description	Quantity
HI93750A-0	Potassium Reagent A	6 drops
HI93750B-0	Potassium Reagent B	1 packet

REAGENT SETS

HI93750-01 Reagents for 100 tests

HI93750-03 Reagents for 300 tests

For other accessories see the Accessories section.

MEASUREMENT PROCEDURE

- Select the **Potassium** method using the procedure described in the Method Selection section.

- Fill the cuvette with 10 mL of sample (up to the mark).



- Add 6 drops of **HI93750A-0** Potassium Reagent A.
Replace the plastic stopper and the cap. Swirl the solution.

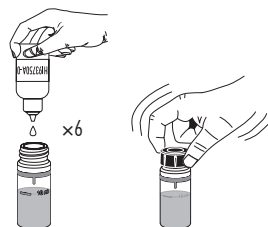

- Insert the cuvette into the holder and close the lid.

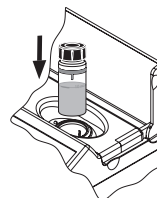

- Press **Zero**. The display will show “-0.0-” when the meter is zeroed and ready for measurement.

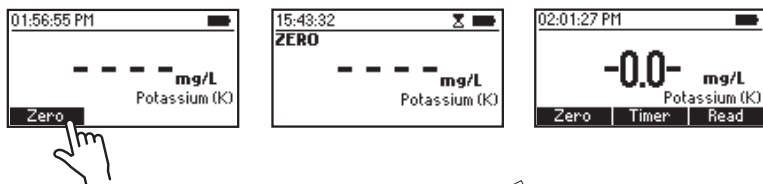

- Add one packet of **HI93750B-0** Potassium Reagent B. Replace the plastic stopper and the cap. Shake gently for 1 minute.

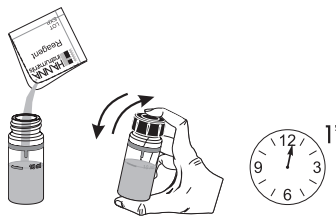

- Insert the cuvette into the holder and close the lid.

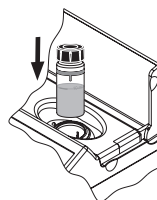

- Press **Timer** and the display will show the countdown prior to the measurement or wait 3 minutes.
- After the 3 minutes have passed, invert the cuvette 5 times to mix.
- Insert the cuvette into the holder and close the lid.
- Press **Read** to start reading. The instrument displays the results in **mg/L of potassium (K)**.

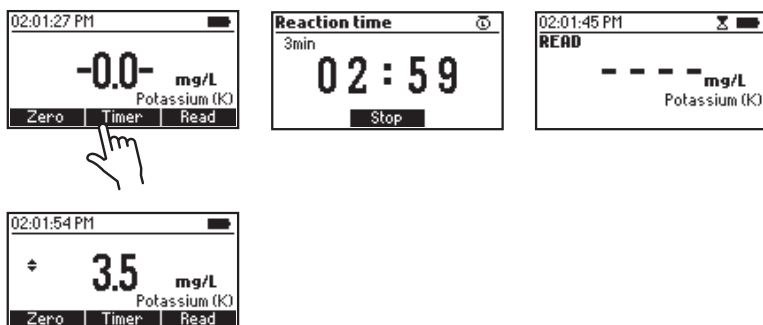

- Press the ▲ or ▼ key to access the second level functions.

- Press **Chem Frm** to convert the result to mg/L of potassium oxide (K_2O).

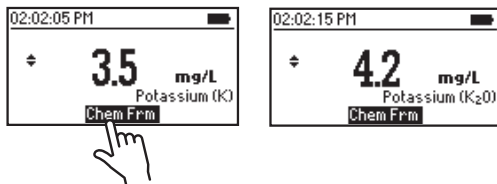

- Press the ▲ or ▼ key to return to the measurement screen.

INTERFERENCES

Interference may be caused by:

- Chloride above 12000 mg/L
- Calcium above 10000 mg/L $CaCO_3$
- Magnesium above 8000 mg/L $CaCO_3$
- Sodium above 8000 mg/L
- Ammonium above 10 mg/L

10.77. Silica Low Range

SPECIFICATIONS

Range	0.00 to 2.00 mg/L (as SiO ₂)
Resolution	0.01 mg/L
Accuracy	±0.03 mg/L ±3 % of reading at 25 °C
Light Source	LED with narrow band interference filter @ 610 nm
Method	Adaptation of the ASTM Manual of Water and Environmental Technology, D859, Heteropoly Molybdenum Blue Method

REQUIRED REAGENTS

Code	Description	Quantity
HI93705A-0	Silica Low Range Reagent A	6 drops
HI93705B-0	Silica Low Range Reagent B	1 packet
HI93705C-0	Silica Low Range Reagent C	1 packet

REAGENT SETS

HI93705-01 Reagents for 100 tests

HI93705-03 Reagents for 300 tests

For other accessories see the Accessories section.

MEASUREMENT PROCEDURE

- Select the [Silica LR](#) method using the procedure described in the Method Selection section.

- Fill the cuvette with 10 mL of unreacted sample (up to the mark).



- Add 6 drops of [HI93705A-0](#) Silica LR Reagent A. Replace the plastic stopper and the cap. Swirl the solution.

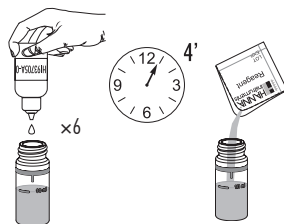

- Press **Timer** and the display will show the countdown prior to adding [HI93705B-0](#) Silica LR Reagent B or wait 4 minutes.

- Add one packet of [HI93705B-0](#) Silica LR Reagent B and shake until it is completely dissolved.

- Press **Continue** and the display will show the countdown or wait 1 minute.



- Insert the cuvette into the holder and close the lid.

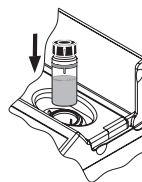

- Press **Zero**. The display will show “-0.0-” when the meter is zeroed and ready for measurement.

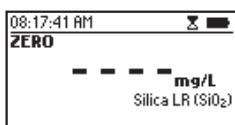
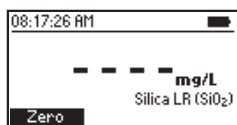

- Remove the cuvette.
- Add one packet of **HI93705C-0** Silica LR Reagent C and shake until it is completely dissolved.

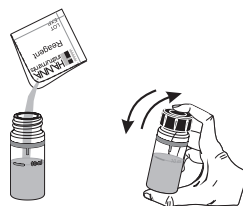

- Insert the cuvette into the holder and close the lid.

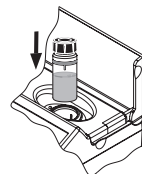

- Press **Timer** and the display will show the countdown prior to the measurement or wait 3 minutes and press **Read**. When the timer ends the meter will perform the reading. The instrument displays result in **mg/L of silica (SiO₂)**.

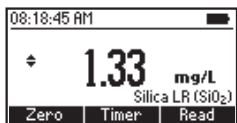
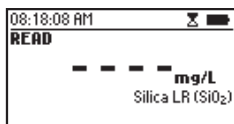

- Press the **▲** or **▼** key to access the second level functions.

- Press **Chem Frm** to convert the result to mg/L of silicon (Si).



- Press the ▲ or ▼ key to return to the measurement screen.

INTERFERENCES

Interference may be caused by:

- Phosphate above 75 mg/L, causes an 11 % reduction in reading
- Phosphate above 60 mg/L, causes a 2 % reduction in reading
- Sulfide and high concentration of iron
- Eliminate color and turbidity interferences by zeroing the meter with the original water sample

10.78. Silica High Range

SPECIFICATIONS

Range	0 to 200 mg/L (as SiO ₂)
Resolution	1 mg/L
Accuracy	± 1 mg/L ± 5 % of reading at 25 °C
Light Source	LED with narrow band interference filter @ 466 nm
Method	Adaptation of the US EPA Method 370.1 for Drinking, Surface and Saline Waters, Domestic and Industrial Wastes & Standard Method 4500-SiO ₂

REQUIRED REAGENTS

Code	Description	Quantity
HI96770A-0	Silica High Range Reagent A	1 packet
HI96770B-0	Silica High Range Reagent B	1 packet
HI96770C-0	Silica High Range Reagent C	1 packet

REAGENT SETS

HI96770-01 Reagents for 100 tests

HI96770-03 Reagents for 300 tests

For other accessories see the Accessories section.

MEASUREMENT PROCEDURE

Select the **Silica HR** method using the procedure described in the Method Selection section.

- Fill the cuvette with 10 mL of unreacted sample (up to the mark).
Replace the plastic stopper and the cap.



- Insert the cuvette into the holder and close the lid.

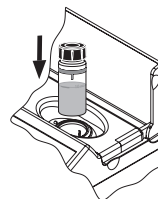

- Press **Zero**. The display will show “-0.0-” when the meter is zeroed and ready for measurement.

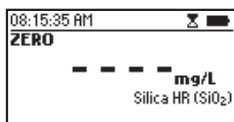

- Remove the cuvette.

- Add one packet of **HI96770A-0** Silica HR Reagent A. Replace the plastic stopper and the cap. Shake vigorously until completely dissolved.

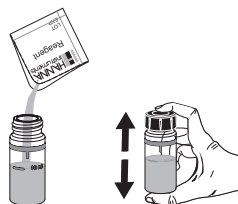

- Add one packet of **HI96770B-0** Silica HR Reagent B. Replace the plastic stopper and the cap. Shake vigorously until completely dissolved.

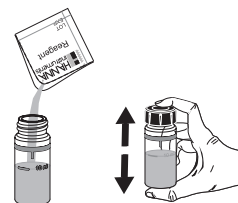

- Press **Timer** and the display will show the countdown prior adding **HI96770C-0** Silica HR Reagent C or wait 10 minutes.



- Add one packet of **HI96770C-0** Silica HR Reagent C. Replace the plastic stopper and the cap. Shake vigorously until completely dissolved.

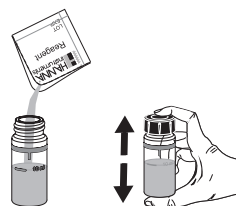

- Insert the cuvette into the holder and close the lid.

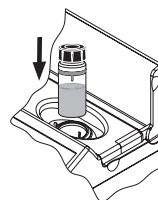

- Press **Continue** and the display will show the countdown prior to the measurement or wait 2 minutes and press **Read**. When the timer ends the meter will perform the reading. The instrument displays the results in **mg/L silica (SiO₂)**.



- Press the **▲** or **▼** key to access the second level functions.
- Press **Chem Frm** to convert the result to **mg/L of silicon (Si)**.

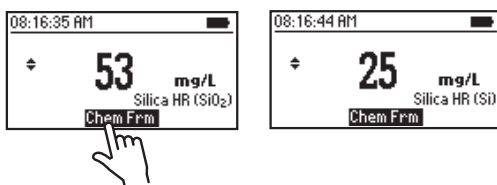

- Press the **▲** or **▼** key to return to the measurement screen.

INTERFERENCES

Interference may be caused by:

- Phosphate above 75 mg/L, causes an 11 % reduction in reading
- Phosphate above 60 mg/L, causes a 2 % reduction in reading
- Sulfide and high concentration of iron
- Eliminate color and turbidity interferences by zeroing the meter with the original water sample

10.79. Silver

SPECIFICATIONS

Range	0.000 to 1.000 mg/L (as Ag)
Resolution	0.001 mg/L
Accuracy	± 0.020 mg/L ± 5 % of reading at 25 °C
Light Source	LED with narrow band interference filter @ 575 nm
Method	Adaptation of the PAN Method

REQUIRED REAGENTS

Code	Description	Quantity
HI93737A-0	Silver Reagent A	1 mL
HI93737B-0	Silver Reagent B	1 mL
HI93737C-0	Silver Reagent C	2 mL
HI93737D-0	Silver Reagent D	2 mL
HI93703-51	Dispersing Agent	6 drops

REAGENT SETS

HI93737-01 Reagents for 50 tests

HI93737-03 Reagents for 150 tests

For other accessories see the Accessories section.

Note: For best results tests should be performed between 20 and 24 °C (68 and 75 °F).

MEASUREMENT PROCEDURE

- Select the **Silver** method using the procedure described in the Method Selection section.

- Fill two graduated beakers with 25 mL of sample.

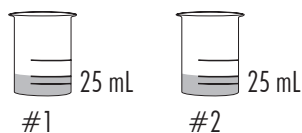

- Add 1 mL of **HI93737A-0** Silver Reagent A to beaker #1 (the blank) and swirl gently to mix.

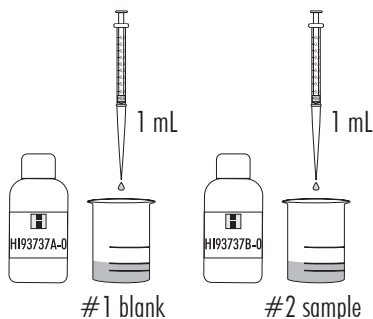

- Add 1 mL of **HI93737B-0** Silver Reagent B to beaker #2 (the sample) and swirl gently to mix.

- Press **Timer** and the display will show the countdown prior to adding **HI93737C-0** Silver Reagent C or wait 2 minutes.

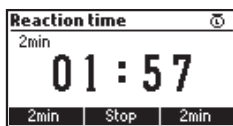
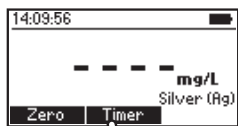

- Add 1 mL of **HI93737C-0** Silver Reagent C to each beaker and swirl.

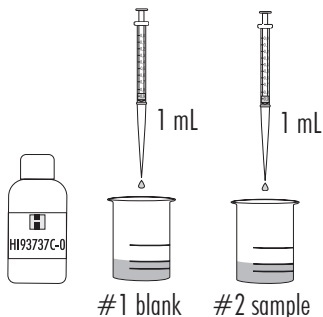

- Press **Continue** and the display will show the countdown prior to adding **HI93737D-0** Silver Reagent D or wait 2 minutes.



- Add 1 mL of **HI93737D-0** Silver Reagent D to each beaker and swirl.

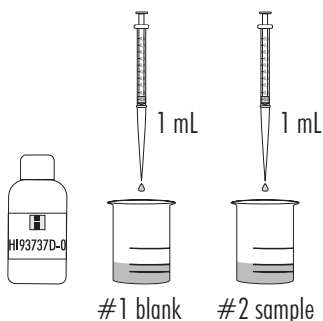

- Press **Continue** and the display will show the countdown or wait 2 minutes.



- Fill cuvette (#1) up with 10 mL of the blank (up to the mark).



- Add 3 drops of [HI93703-51](#) Dispersing Agent, replace the plastic stopper and the cap. Invert gently for 10 seconds.

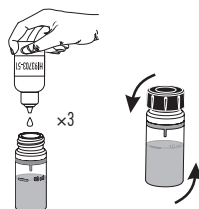

- Insert the cuvette into the holder and close the lid.

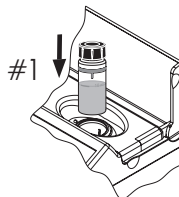

- Press **Zero**. The display will show "-0.0-" when the meter is zeroed and ready for measurement.

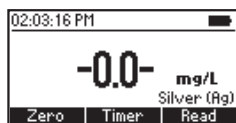
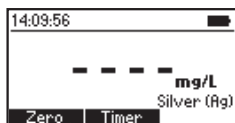

- Fill a second cuvette (#2) up with 10 mL of the reacted sample (up to the mark).

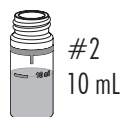

- Add 3 drops of [HI93703-51](#) Dispersing Agent, replace the plastic stopper and the cap. Invert gently for 10 seconds.

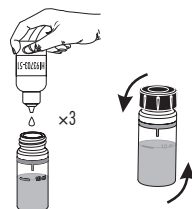

- Insert the second cuvette (#2) into the holder and close the lid.

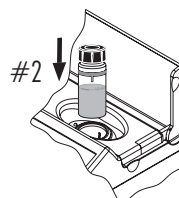

- Press **Read** to start the reading. The instrument displays the results in mg/L of silver (Ag).

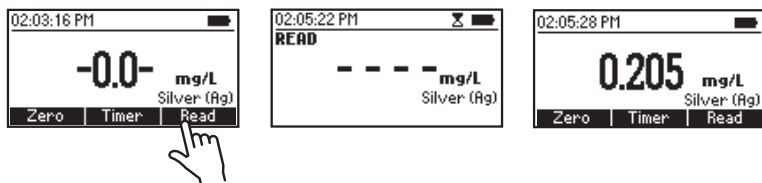

INTERFERENCES

Interference may be caused by:

- Chloride above 8000 mg/L
- Sodium above 5000 mg/L
- Calcium, Magnesium above 1000 mg/L CaCO_3
- Potassium above 500 mg/L
- Aluminum, Zinc above 30 mg/L
- Chromium(VI) above 40 mg/L
- Manganese above 25 mg/L
- Cadmium, Chromium(III), Fluoride, Lead above 20 mg/L
- Copper above 15 mg/L
- Iron (Ferric) above 10 mg/L
- Cobalt, Iron (Ferrous), Nickel above 1.5 mg/L

10.80. Sulfate

SPECIFICATIONS

Range	0 to 150 mg/L (as SO_4^{2-})
Resolution	1 mg/L
Accuracy	± 5 mg/L ± 3 % of reading at 25 °C
Light Source	LED with narrow band interference filter @ 466 nm
Method	Sulfate is precipitated with barium chloride crystals

REQUIRED REAGENTS

Code	Description	Quantity
HI93751-0	Sulfate Reagent	1 packet

REAGENT SETS

HI93751-01 Reagents for 100 tests

HI93751-03 Reagents for 300 tests

For other accessories see the Accessories section.

MEASUREMENT PROCEDURE

- Select the **Sulfate** method using the procedure described in the Method Selection section.

- Fill a cuvette with 10 mL of unreacted sample (up to the mark).
Replace the plastic stopper and the cap.



- Insert the cuvette into the holder and close the lid.

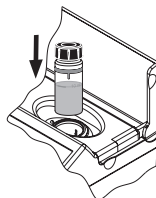

- Press **Zero**. The display will show “-0.0-” when the meter is zeroed and ready for measurement.

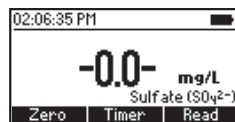
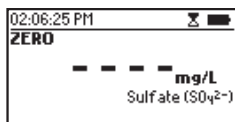
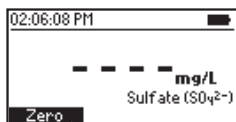

- Add one packet of **HI93751-0** Sulfate Reagent.
- Replace the plastic stopper and the cap. Invert gently for 1 minute (about 30 inversions).

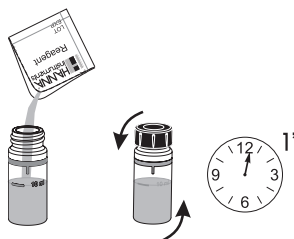

- Insert the cuvette into the holder and close the lid.

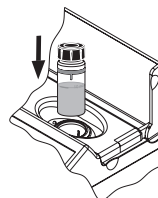

- Press **Timer** and the display will show the countdown prior to the measurement or wait 5 minutes and press **Read**. When the timer ends the meter will perform the reading. The instrument displays the concentration in **mg/L** of sulfate (SO_4^{2-}).

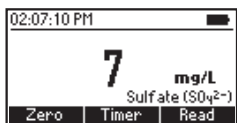
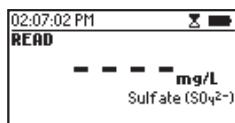
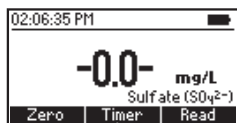

INTERFERENCES

Interference may be caused by:

- Chloride above 40000 mg/L
- Calcium above 20000 mg/L CaCO_3
- Magnesium above 10000 mg/L MgCO_3
- Silica above 500 mg/L SiO_2
- Color or suspended matter, filter the sample prior to analysis
- Organic matter in large amounts may impede the precipitation of barium sulfate

10.81. Surfactants, Anionic

SPECIFICATIONS

Range	0.00 to 3.50 mg/L (as SDBS)
Resolution	0.01 mg/L
Accuracy	± 0.04 mg/L ± 3 % of reading
Light Source	LED with narrow band interference filter @ 610 nm
Method	Adaptation of the US EPA Method 425.1 and Standard Methods for the Examination of Water & Wastewater, 20 th Edition, 5540C, Anionic Surfactants as MBAS

REQUIRED REAGENTS

Code	Description	Quantity
HI95769A-0	Anionic Surfactants Reagent A	4 drops
HI95769B-0	Anionic Surfactants Reagent B	2 drops
-	Chloroform Reagent	10 mL
DEIONIZED120	Deionized Water	15 mL

REAGENT SETS

HI95769-01 Reagents for 40 tests
For other accessories see the Accessories section.

MEASUREMENT PROCEDURE

- Select the [Surfactants \(Anionic\)](#) method using the procedure described in the Method Selection section.

- Fill the graduated glass vial with 25 mL of sample.

Note: For improved accuracy the use of class A laboratory pipettes is recommended.

- Add 2 drops of HI95769A-0 Anionic Surfactants Reagent A and 2 drops of HI95769B-0 Anionic Surfactants Reagent B.

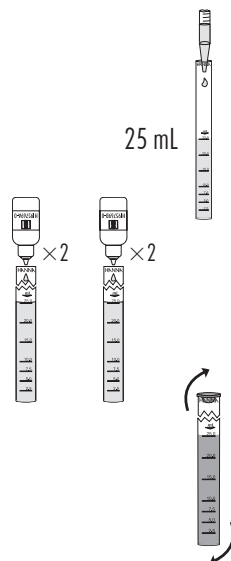

- Replace the cap and invert to mix, the solution will turn blue.

- Add 10 mL of Chloroform.

Note: Chloroform is more dense than water and will sink to the bottom of the graduated glass vial.

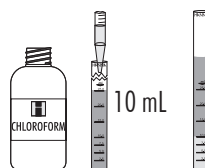

- Invert the vial twice and remove the cap to release any pressure that has built up.

- Replace the cap and shake it vigorously for 30 seconds.

Note: Ensure the cap is secure when shaking.

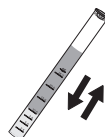

- Press **Timer** and the display will show the countdown or wait 2 minutes. During this period the chloroform layer separates from the aqueous layer, the color of the aqueous layer will fade slightly, while the chloroform layer will turn blue.

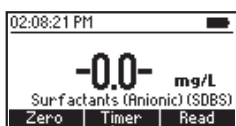

- Remove the cap.

- Remove the upper aqueous layer using the long plastic pipette, do not remove the lower chloroform layer.

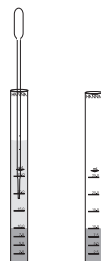

- Add 15 mL of deionized water to the vial (up to the 25 mL mark).

- Add 2 drops of **HI95769A-0** Anionic Surfactants Reagent A.

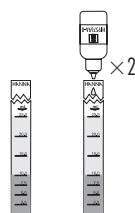

- Invert the vial twice and remove the cap to release any pressure that has built up.

- Replace the cap and shake it vigorously for 30 seconds.

Note: Ensure the cap is secure when shaking.

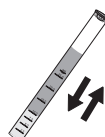

- Press **Continue** and the display will show the countdown or wait 2 minutes. During this period, the chloroform layer separates from the aqueous layer.

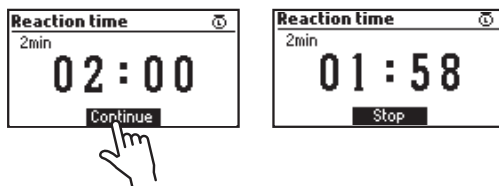

- Remove the cap.
- Insert a clean plastic pipette below the upper aqueous layer to transfer the lower chloroform layer into a cuvette. Do not transfer any of the upper aqueous layer.



Notes: The solution in the cuvette must be clear. If the solution is cloudy, the separation between the chloroform and aqueous layer can be improved by gently warming the vial (holding the vial in your hand). If the chloroform layer contains some aqueous drops hanging on the cuvette wall, gently swirl or invert the cuvette. It is important to transfer at least 7 mL of chloroform layer into the measurement cuvette, thus up to 0.5 cm (1/4") below the 10 mL mark. If the transferred volume is lower than 7 mL, the accuracy of the test may be affected. Please repeat the test waiting for longer than 2 minutes to allow complete separation between the two phases.

- Replace the plastic stopper and the cap. This is the reacted sample (#2).



#2 sample

- Fill another cuvette with 10 mL of Chloroform Reagent (up to the mark). Replace the plastic stopper and the cap. This is the blank (#1).



#1 blank

- Insert the blank (cuvette #1) into the holder and close the lid.

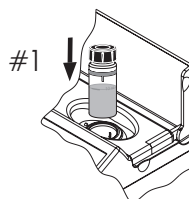

- Press **Zero**. The display will show “-0.0-” when the meter is zeroed and ready for measurement.

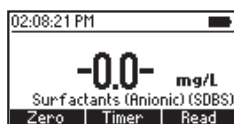
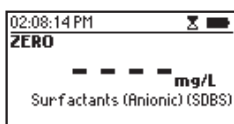
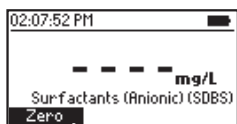

- Remove the cuvette.
- Insert the reacted sample (#2) into the instrument and close the lid.

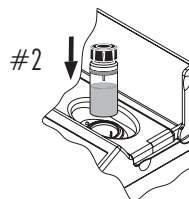

- Press **Read** to start the reading. The instrument displays the result in mg/L as SDBS.

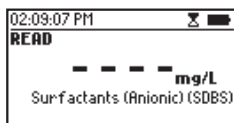

INTERFERENCES

Interference may be caused by:

- Absorption particulate matter, Cationic surfactants, Strong oxidants (Cl_2 , H_2O_2 , $\text{S}_2\text{O}_8^{2-}$ etc.), Sulfide cause negative interference
- Organic sulfates, Sulfonates cause positive interference
- Highly buffered samples or with extreme pH may exceed the buffering capacity of the reagent, pH should be adjusted between 4 and 9 with diluted NaOH or HCl prior to addition of the reagent

10.82. Surfactants, Anionic (16 mm Vial)

SPECIFICATIONS

Range	0.00 to 3.50 mg/L (as SDBS)
Resolution	0.01 mg/L
Accuracy	± 0.10 mg/L $\pm 5\%$ of reading
Light Source	LED with narrow band interference filter @ 610 nm
Method	Adaptation of the Standard Method for the Examination of Water and Wastewater, 23 rd Edition, 5540C, Anionic Surfactants as MBAS

REQUIRED REAGENTS

Code	Description	Quantity
HI96782V-0*	Anionic Surfactants Reagent Vial	1 vial
HI96782A-0	Anionic Surfactants Buffer Reagent A	0.6 mL
HI96782B-0	Anionic Surfactants Indicator Reagent B	0.2 mL

*Reagent vial identification: ANIONIC, white label

REAGENT SETS

HI96782-25 Reagents for 25 tests

For other accessories see the Accessories section.

Note: Store the unused vials in their packaging in a dark place, between 15 and 25°C (59 and 77 °F).

PRINCIPLE

Determination of anionic surfactants by measurement of the Methylene Blue Active Substances (MBAS) index. Anionic surfactants react with methylene blue in an alkaline medium, this reaction results in salts that are extracted using chloroform. The blue color of the organic phase is determined photometrically.

APPLICATION

Water, wastewater, surface water, formulations, degreasing baths, wash solutions, process analysis

SIGNIFICANCE & USE

Surfactants decrease surface tension at the interface between a liquid and another solid, liquid, or gaseous phase, they are used in industry, agriculture, scientific studies and everyday life (cleaning agents, spot removers, cosmetics, etc.). The most widely used anionic surfactants include sodium dodecyl sulfate (SDS), sodium dodecylbenzene sulfonate (SDBS), sodium dodecane sulfonate (SDSA), sodium dioctyl sulfosuccinate (SDOSSA).

MEASUREMENT PROCEDURE

- Select the **Surfactants (Anionic) (16)** method using the procedure described in the Method Selection section.

- Insert the 16 mm vial adapter using the procedure described in the Using the 16 mm Vial Adapter section.

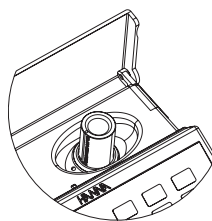

- Insert the **HI96782V-0** Anionic Surfactants Reagent Vial into the holder.

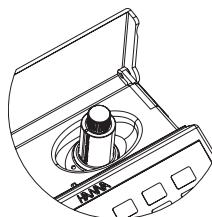

- Press **Zero**. The display will show “-0.0-” when the meter is zeroed and ready for measurement.

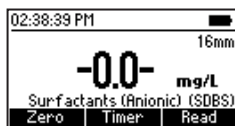
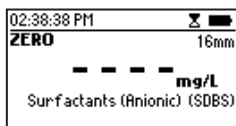
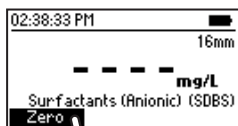

- Remove the blank vial.
- Add 5 mL of sample to the vial, while keeping the vial at a 45-degree angle.

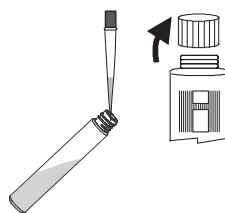

- Add 0.6 mL of **HI96782A-0** Anionic Surfactants Buffer Reagent A and 0.2 mL of **HI96782B-0** Anionic Surfactants Indicator Reagent B.



HI96782A-0



HI96782B-0

- Replace the cap and invert for 1 minute (about 45 inversions).

Note: This method is technique sensitive. See procedure described in the Cuvette Preparation section for proper mixing technique. If the vial is inverted too slowly the extraction may be incomplete resulting in low readings.

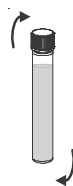

- Press **Timer** and the display will show the countdown or wait 1 minute. During this period the organic layer separates from the aqueous layer.

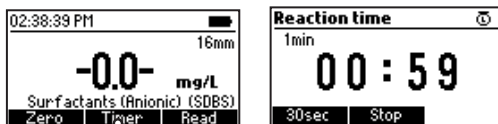

- Invert the vial gently two times.
- Press **Continue** and the display will show the countdown or wait 30 seconds. During this period, the organic layer separates from the aqueous layer.

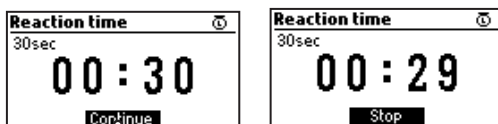

- Insert the vial into the holder.

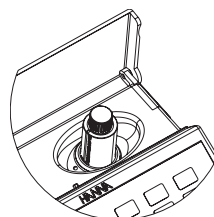

Note: Phase separation must be complete before the measurement is taken. If the solution is cloudy, the separation between the organic and aqueous layer can be improved by gently warming the vial (hold the vial in hand). If the organic layer contains some aqueous drops hanging on the vial wall, gently swirl or invert the vial.

- Press **Read** to start the reading. The instrument displays the result in mg/L as SDBS.

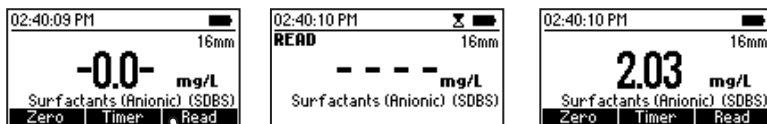

INTERFERENCES

Interference may be caused by:

- Cationic surfactants cause negative interference
- Bicarbonate above 2000 mg/L
- Potassium, Sodium, Sulfate, Chloride above 1000 mg/L
- Phosphate above 300 mg/L
- Magnesium above 250 mg/L
- Calcium, Nitrate above 100 mg/L
- Chromium(VI), Copper above 10 mg/L
- Nickel, Zinc, Iron (Ferric) above 5 mg/L

10.83. Surfactants, Cationic (16 mm Vial)

SPECIFICATIONS

Range	0.00 to 2.50 mg/L (as CTAB)
Resolution	0.01 mg/L
Accuracy	± 0.15 ppm ± 3 % of reading
Light Source	LED with narrow band interference filter @ 420 nm
Method	Bromophenol Blue Method

REQUIRED REAGENTS

Code	Description	Quantity
HI96785V-0	Cationic Surfactants Reagent Vial	1 vial
HI96785-0	Cationic Surfactants Reagent	1 packet

REAGENT SETS

HI96785-25 Reagents for 25 tests

For other accessories see the Accessories section.

Note: Store the unused vials in their packaging in a dark place, between 15 and 25°C (59 and 77°F).

PRINCIPLE

Determination of cationic surfactants by measurement of the Methylene Blue Active Substances (MBAS) index. Cationic surfactants react with methylene blue in an acid medium, this reaction results in salts that are extracted using chloroform. The yellow color of the organic phase is determined photometrically.

Note: The sample temperature must be between 20 and 22°C (68 and 72°F), and the pH of the sample between 4 and 9.

APPLICATION

Water, wastewater, surface water, formulations, degreasing baths, wash solutions, process analysis

SIGNIFICANCE & USE

Cationic surfactants are positively charged at their hydrophilic ends and as such are active agents in fabric softeners, an important group of detergent products.

Most cationic surfactants find use as disinfectants and sanitizers and include:

Hexadecyltrimethylammonium bromide (CTAB), Benzalkonium chloride (BAC), Cetylpyridinium chloride (CPC), Benzethonium chloride (BZT).

MEASUREMENT PROCEDURE

- Select the **Surfactants (Cationic) (16)** method using the procedure described in the Method Selection section.
- Insert the 16 mm vial adapter using the procedure described in the Using the 16 mm Vial Adapter section.

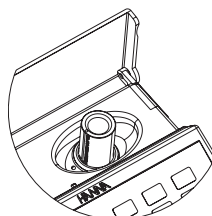

- Insert the **HI96785V-0** Cationic Surfactants Reagent Vial into the holder.

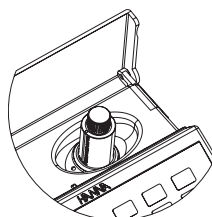

- Press **Zero**. The display will show “-0.0-” when the meter is zeroed and ready for measurement.

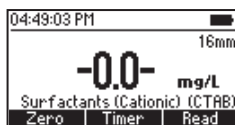
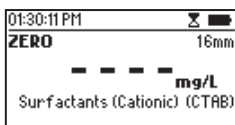
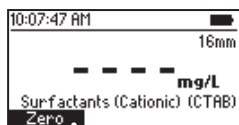

- Remove the vial.

- Remove the cap and add 5 mL of sample to the vial, while keeping the vial at a 45-degree angle.

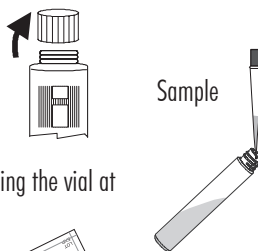

- Add one packet of **HI96785-0** Cationic Surfactants Reagent.
- Replace the cap and invert for 2 minutes to mix.

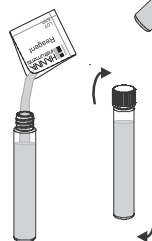

Note: This method is technique sensitive. See the *Cuvette Preparation* section for proper mixing technique. If the vial is inverted too slowly the extraction may be incomplete resulting in low readings.

- Press **Timer** and the display will show the countdown or wait 30 seconds. During this period the organic layer separates from the aqueous layer.

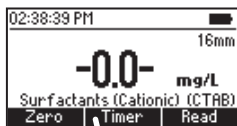

- Invert the vial gently two times.
- Wait for phase separation.

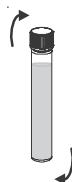

- Wipe the vial thoroughly with [HI731318](#) microfiber cleaning cloth or a lint-free wipe prior to insertion.

- Insert the vial into the holder.

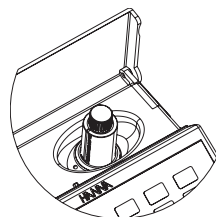

***Note:** Phase separation must be complete before the measurement is taken. If the solution is cloudy, the separation between the organic and aqueous layer can be improved by gently warming the capped vial (hold the vial in hand). If the organic layer contains some aqueous drops hanging on the vial wall, gently swirl or invert the vial. The phase separation may take several hours if the vial is inverted or shaken too vigorously!*

- Press **Read** to start the reading. The instrument displays the result in **mg/L** as **CTAB**.

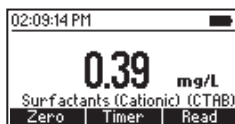
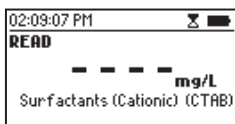

INTERFERENCES

Interference may be caused by:

- Chloride above 3000 mg/L
- Sodium above 2000 mg/L
- Carbonate, Sulfate, Potassium, Nitrate above 1000 mg/L
- Calcium above 500 mg/L
- Phosphate above 300 mg/L
- Ammonium, Magnesium above 250 mg/L
- Iron (Ferric), Nitrite above 100 mg/L
- Zinc, Nickel, Copper, Iron (Ferrous), Hydrogen peroxide (H_2O_2), Disulfite ($\text{S}_2\text{O}_5^{2-}$) above 50 mg/L
- Chlorine, Chromium (VI), Chromium (III) above 10 mg/L
- Anionic surfactants cause negative interference

Interferences checked individually in solution containing 1 mg/L of CTAB (Hexadecyltrimethylammonium bromide).

The cumulative effects have not been determined but can not be excluded.

The determination is not yet interfered with up to the concentrations of foreign substances given above.

10.84. Surfactants, Nonionic (16 mm Vial)

SPECIFICATIONS

Range	0.00 to 6.00 mg/L (as TRITON X-100)
Resolution	0.01 mg/L
Accuracy	± 0.10 mg/L $\pm 5\%$ of reading
Light Source	LED with narrow band interference filter @ 610 nm
Method	TBPE Method

REQUIRED REAGENTS

Code	Description	Quantity
HI96780V-0*	Surfactants Nonionic Reagent Vial	1 vial

*Reagent vial identification: NON IONIC, blue label

REAGENT SETS

HI96780-25 Reagents for 24 tests

For other accessories see the Accessories section.

Note: Store the unused vials in their packaging in a dark place, between 15 and 25 °C (59 and 77 °F).

PRINCIPLE

Nonionic surfactants (ethoxylates with 3 to 20 ether bridges) react with the indicator TBPE to form a green complex, which is then extracted in dichloromethane and photometrically evaluated. This method has a strong temperature and pH dependence. The sample temperature must be between 20 and 22 °C (68 and 72 °F), and the pH between 4 and 9.

APPLICATION

Water, wastewater, surface water, formulations, degreasing baths, wash solutions, process analysis

SIGNIFICANCE & USE

Surfactants are one of many different compounds that make up a detergent. Nonionic surfactants do not bear an electrical charge and are often used together with anionic surfactants. Nonionic surfactants account for nearly 50 % of surfactant production. Nonionic surfactants are more surface active and better emulsifiers than anionic surfactants at similar concentrations. They are less soluble than anionic surfactants in hot water and produce less foam. They are more efficient in removing oily and organic dirt. Nonionics are used in fabric washing detergents, hard surface cleaners and in many industrial processes such as emulsion polymerization and agrochemical formulations.

MEASUREMENT PROCEDURE



Before using the reagent kit carefully read all the instructions and the Safety Data Sheets (SDS). Pay particular attention to all warnings, cautions and notes. Failure to do so may result in serious injury to the operator.

Reagent Blank Correction: This method requires a reagent blank correction. A single blank vial may be used more than once. For improved accuracy use the same lot of reagents for the blank and sample, and run a blank for each set of measurements.

- Select the **Surf. (Nonionic) (16)** method using the procedure described in the Method Selection section.
- Remove the cap from two **HI96780V-0** Surfactants Nonionic Reagent Vials.



- Add 3 mL of deionized water to the first vial (#1) and 3 mL of sample to the second vial (#2), while keeping the vials at a 45-degree angle.

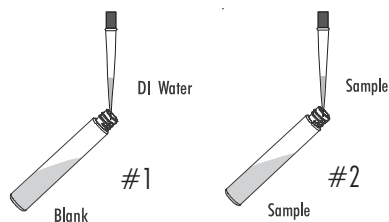

- Replace the cap and invert for 2 minutes (about 2 inverts per second).

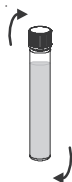

Note: This method is technique sensitive. See the *Cuvette Preparation* section for proper mixing technique. If the vial is inverted too slowly the extraction may be incomplete resulting in low readings.

- Press **Timer** and the display will show the countdown or wait 2 minutes. During this period the organic layer separates from the aqueous layer.

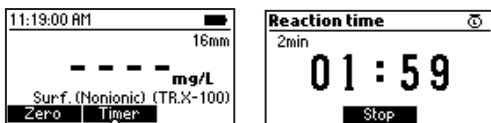

Note: Phase separation must be complete before the measurement is taken. If the organic layer contains some aqueous drops hanging on the vial wall, gently swirl or invert the vial.

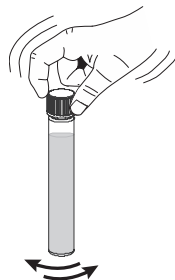

- Insert the 16 mm vial adapter using the procedure described in the Using the 16 mm Vial Adapter section.
- Insert the blank vial (#1) into the holder.

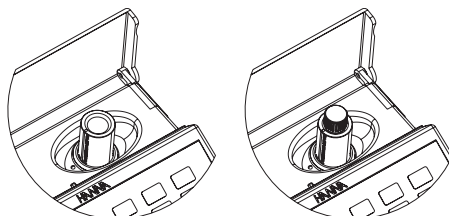

#1

- Press **Zero**. The display will show "-0.0-" when the meter is zeroed and ready for measurement.

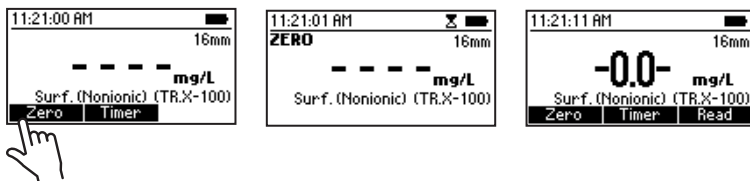

- Remove the blank vial.

- Insert the sample vial (#2) into the holder.

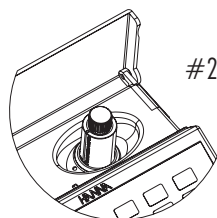

- Press **Read** to start the reading. The instrument displays the results in **mg/L** of TRITON X-100.

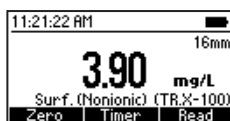
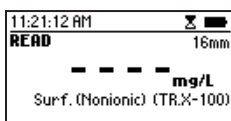
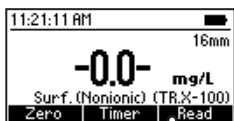

INTERFERENCES

Interference may be caused by:

- Chloride, Nitrate, Sulfate, above 20000 mg/L
- Calcium above 500 mg/L
- Aluminum, Ammonium, Magnesium above 200 mg/L
- Copper, Iron (Ferric), Zinc above 50 mg/L
- Cationic surfactants cause positive interference
- Anionic surfactants cause negative interference

10.85. Zinc

SPECIFICATIONS

Range	0.00 to 3.00 mg/L (as Zn)
Resolution	0.01 mg/L
Accuracy	± 0.03 mg/L ± 3 % of reading at 25 °C
Light Source	LED with narrow band interference filter @ 575 nm
Method	Adaptation of Standard Methods for the Examination of Water and Wastewater, 18 th Edition, Zincon Method

REQUIRED REAGENT

Code	Description	Quantity
HI93731A-0	Zinc Reagent A	1 packet
HI93731B-0	Zinc Reagent B	0.5 mL

REAGENT SETS

HI93731-01 Reagents for 100 tests

HI93731-03 Reagents for 300 tests

For other accessories see the Accessories section.

MEASUREMENT PROCEDURE

- Select the **Zinc** method using the procedure described in the Method Selection section.

- Fill the graduated glass vial up to the 20 mL mark with the sample.

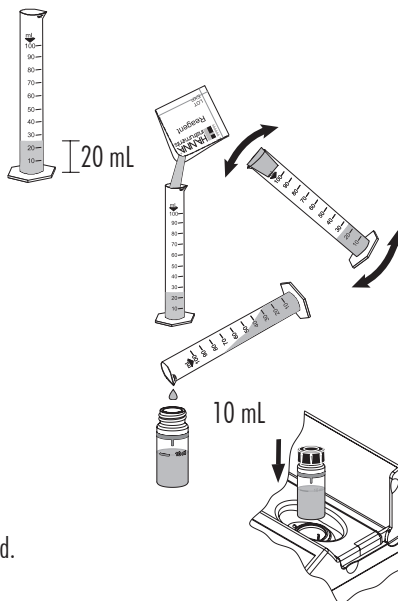

- Add one packet of **HI93731A-0** Zinc Reagent A, close the cylinder. Invert several times to mix until completely dissolved.

- Fill a cuvette with 10 mL of the reacted sample (up to the mark). Replace the plastic stopper and the cap.

- Insert the cuvette into the holder and close the lid.

- Press **Zero**. The display will show “-0.0-” when the meter is zeroed and ready for measurement.

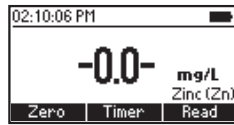
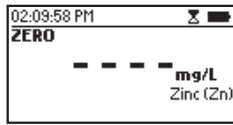
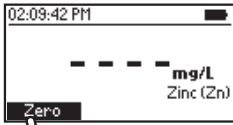

- Add 0.5 mL of **HI93731B-0** Zinc Reagent B to the cuvette. Replace the plastic stopper and the cap. Swirl gently for 15 seconds.

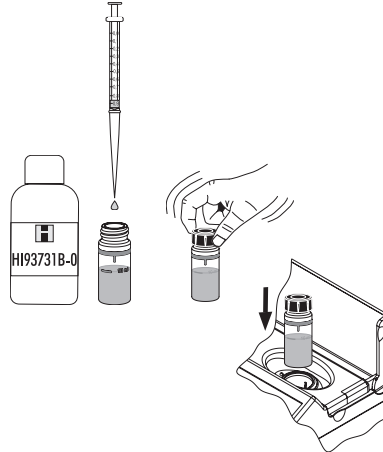

- Insert the sample into the instrument and close the lid.

- Press **Timer** and the display will show the countdown prior to the measurement or wait 3 minutes and 30 seconds and press **Read**. When the timer ends the meter will perform the reading. The instrument displays the results in **mg/L** of zinc (Zn).

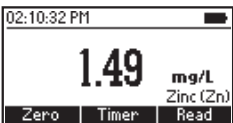
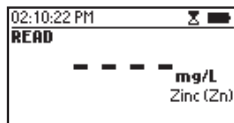
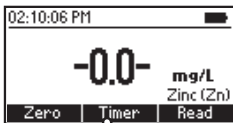

INTERFERENCES

Interference may be caused by:

- Iron above 7 mg/L
- Aluminum above 6 mg/L
- Copper, Manganese, Nickel above 5 mg/L
- Cadmium above 0.5 mg/L

11. WARNINGS & ERRORS

The instrument shows clear warning messages when erroneous conditions appear and when measured values are outside the expected range. The information below provides an explanation of the errors and warnings, and recommended action to be taken.

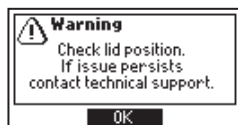

There is an excess amount of ambient light reaching the detector. Make sure the lid is closed before performing any measurements. If the issue persists, please contact Hanna Instruments® technical support.

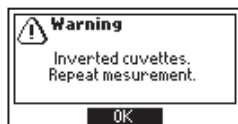

The sample and the zero cuvettes are inverted. Swap the cuvettes and repeat the measurement.

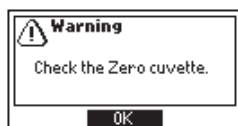

There is either too much light or the instrument can not adjust light level. Please check the preparation of the zero cuvette and that the sample does not contain any debris.



The meter is either overheating or its temperature has dropped too low to operate within published accuracy specifications.



The meter must be between 0 and 50 °C (32 and 122 °F) to perform any measurements.



Meter temperature has changed significantly since the zero measurement has been performed. The zero measurement must be performed again.

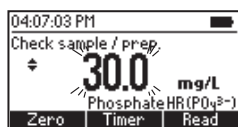

The measured value is outside the limits of the method. If possible, change the method range. Verify that the sample does not contain any debris. Check the sample preparation and the measurement preparation.

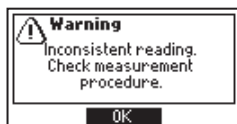

The measured value cannot be calculated.
Please check sample preparation and measurement procedure.



Stored results of the CAL Check™ measurements have been lost.
Please redo the CAL Check measurements to ensure accurate results.



User settings have been lost.
Please reset the values. If the issue persists, please contact Hanna Instruments® technical support.



Flash drive is not recognized or it might be damaged.
Please insert a new USB flash drive.



Data log is full.
Please review logged data and delete unnecessary logs.



Date and time settings have been lost.
Please reset the values. If the issue persists, please contact Hanna Instruments technical support.

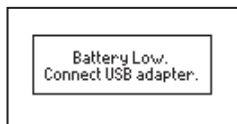

Battery level is too low to ensure normal functioning and the meter will turn off.
Connect the USB adapter to charge the battery.

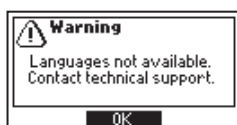

English is the only available language. Some features are no longer available.
Restart the meter. If the issue persists, please contact Hanna Instruments technical support.



Real time clock is not accurate. Some features are no longer available.

Restart the meter. If the issue persists, please contact Hanna Instruments technical support.

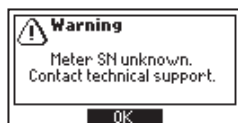

The device serial number can not be identified. Some features are no longer available.

Restart the meter. If the issue persists, please contact Hanna Instruments technical support.



Logged data is no longer accessible. Some features are no longer available.

Restart the meter. If the issue persists, please contact Hanna Instruments® technical support.



Battery charge level is not accurate. Some features are no longer available.

Restart the meter. If the issue persists, please contact Hanna Instruments technical support.

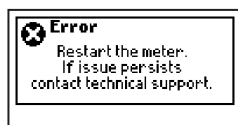

A critical error has occurred.

Restart the meter. If the issue persists, please contact Hanna Instruments technical support.

12. STANDARD METHODS

Description	Range	Method
Alkalinity	0 to 500 mg/L (as CaCO ₃)	Colorimetric
Alkalinity, Marine	0 to 300 mg/L (as CaCO ₃)	Colorimetric
Aluminum	0.00 to 1.00 mg/L (as Al ³⁺)	Aluminon
Ammonia LR	0.00 to 3.00 mg/L (as NH ₃ -N)	Nessler
Ammonia LR (16 mm Vial)	0.00 to 3.00 mg/L (as NH ₃ -N)	Nessler
Ammonia MR	0.00 to 10.00 mg/L (as NH ₃ -N)	Nessler
Ammonia HR	0.0 to 100.0 mg/L (as NH ₃ -N)	Nessler
Ammonia HR (16 mm Vial)	0.0 to 100.0 mg/L (as NH ₃ -N)	Nessler
Bromine	0.00 to 8.00 mg/L (as Br ₂)	DPD
Calcium	0 to 400 mg/L (as Ca ²⁺)	Oxalate
Calcium Marine	200 to 600 mg/L (as Ca ²⁺)	Zincon
Chloride	0.0 to 20.0 mg/L (as Cl ⁻)	Mercury(II) Thiocyanate
Chlorine Dioxide	0.00 to 2.00 mg/L (as ClO ₂)	Chlorophenol Red
Chlorine Dioxide, Rapid Method	0.00 to 2.00 mg/L (as ClO ₂)	DPD
Chlorine, Free	0.00 to 5.00 mg/L (as Cl ₂)	DPD
Chlorine, Free ULR	0.000 to 0.500 mg/L (as Cl ₂)	DPD
Chlorine, Total	0.00 to 5.00 mg/L (as Cl ₂)	DPD
Chlorine, Total ULR	0.000 to 0.500 mg/L (as Cl ₂)	DPD
Chlorine, Total UHR	0 to 500 mg/L (as Cl ₂)	Standard Methods 4500-Cl
Chromium(VI) LR	0 to 300 μg/L (as Cr(VI))	Diphenylcarbohydrazide
Chromium(VI) HR	0 to 1000 μg/L (as Cr(VI))	Diphenylcarbohydrazide
Chromium(VI)/Total (16 mm Vial)	0 to 1000 μg/L (as Cr)	Diphenylcarbazide
Chemical Oxygen Demand LR (16 mm Vial)	0 to 150 mg/L (as O ₂)	EPA 410.4
Chemical Oxygen Demand MR (16 mm Vial)	0 to 1500 mg/L (as O ₂)	EPA 410.4
Chemical Oxygen Demand HR (16 mm Vial)	0 to 15000 mg/L (as O ₂)	EPA 410.4
Chemical Oxygen Demand UHR (16 mm Vial)	0 to 60.0 g/L (as O ₂)	EPA 410.4
Color of Water	0 to 500 PCU	Colorimetric Platinum Cobalt
Copper LR	0.000 to 1.500 mg/L (as Cu ²⁺)	Bicinchoninate
Copper HR	0.00 to 5.00 mg/L (as Cu ²⁺)	Bicinchoninate
Cyanuric Acid	0 to 80 mg/L (as CYA)	Turbidimetric
Fluoride LR	0.00 to 2.00 mg/L (as F ⁻)	SPADNS

Description	Range	Method
Fluoride HR	0.0 to 20.0 mg/L (as F ⁻)	SPADNS
Hardness, Calcium	0.00 to 2.70 mg/L (as CaCO ₃)	Calmagite
Hardness, Magnesium	0.00 to 2.00 mg/L (as CaCO ₃)	EDTA
Hardness, Total LR	0 to 250 mg/L (as CaCO ₃)	EPA 130.1
Hardness, Total MR	200 to 500 mg/L (as CaCO ₃)	EPA 130.1
Hardness, Total HR	400 to 750 mg/L (as CaCO ₃)	EPA 130.1
Hydrazine	0 to 400 µg/L (as N ₂ H ₄)	p-Dimethylaminobenzaldehyde
Iodine	0.0 to 12.5 mg/L (as I ₂)	DPD
Iron LR	0.000 to 1.600 mg/L (as Fe)	TPTZ
Iron HR	0.00 to 5.00 mg/L (as Fe)	Phenanthroline
Iron(II)	0.00 to 6.00 mg/L (as Fe ²⁺)	EPA 315B
Iron(II)/(III)	0.00 to 6.00 mg/L (as Fe)	EPA 315B
Iron (16 mm Vial)	0.00 to 6.00 mg/L (as Fe)	Phenanthroline
Iron, Total (16 mm Vial)	0.00 to 7.00 mg/L (as Fe)	EPA 315B
Magnesium	0 to 150 mg/L (as Mg ²⁺)	Calmagite
Manganese LR	0 to 300 µg/L (as Mn)	PAN
Manganese HR	0.0 to 20.0 mg/L (as Mn)	Periodate
Molybdenum	0.0 to 40.0 mg/L (as Mo ⁶⁺)	Mercaptoacetic Acid
Nickel LR	0.000 to 1.000 mg/L (as Ni)	PAN
Nickel HR	0.00 to 7.00 g/L (as Ni)	Colorimetric
Nitrate	0.0 to 30.0 mg/L (as NO ₃ ⁻ - N)	Cadmium reduction
Nitrate (16 mm Vial)	0.0 to 30.0 mg/L (as NO ₃ ⁻ - N)	Chromotropic Acid
Nitrite, Marine ULR	0 to 200 µg/L (as NO ₂ ⁻ - N)	Diazotization
Nitrite LR	0 to 600 µg/L (as NO ₂ ⁻ - N)	Diazotization
Nitrite LR (16 mm Vial)	0 to 600 µg/L (as NO ₂ ⁻ - N)	Diazotization
Nitrite MR (16 mm Vial)	0.00 to 6.00 mg/L (as NO ₂ ⁻ - N)	Diazotization
Nitrite HR	0 to 150 mg/L (as NO ₂ ⁻)	Ferrous Sulfate
Nitrogen, Total LR (16 mm Vial)	0.0 to 25.0 mg/L (as N)	Chromotropic Acid
Nitrogen, Total HR (16 mm Vial)	10 to 150 mg/L (as N)	Chromotropic Acid
Oxygen, Dissolved	0.0 to 10.0 mg/L (as O ₂)	Winkler
Oxygen Scavengers (Carbohydrazide)	0.00-1.50 mg/L (as Carbohydrazide)	Iron Reduction
Oxygen Scavengers (DEHA)	0 to 1000 µg/L (as DEHA)	Iron Reduction
Oxygen Scavengers (Hydroquinone)	0.00-2.50 mg/L (as Hydroquinone)	Iron Reduction

Description	Range	Method
Oxygen Scavengers (Iso-Ascorbic Acid)	0.00-4.50 mg/L (as Iso-Ascorbic Acid)	Iron Reduction
Ozone	0.00 to 2.00 mg/L (as O ₃)	DPD
pH	6.5 to 8.5 pH	Phenol Red
Phosphate, Marine ULR	0 to 200 µg/L (as P)	Ascorbic Acid
Phosphate LR	0.00 to 2.50 mg/L (as PO ₄ ³⁻)	Ascorbic Acid
Phosphate HR	0.0 to 30.0 mg/L (as PO ₄ ³⁻)	Amino Acid
Phosphorus, Reactive LR (16 mm Vial)	0.00 to 1.60 mg/L (as P)	Ascorbic Acid
Phosphorus, Reactive HR (16 mm Vial)	0.0 to 32.6 mg/L (as P)	Vanadomolybdophosphoric Acid
Phosphorus, Acid Hydrolyzable (16 mm Vial)	0.00 to 1.60 mg/L (as P)	Ascorbic Acid
Phosphorus, Total LR (16 mm Vial)	0.00 to 1.15 mg/L (as P)	Ascorbic Acid
Phosphorus, Total HR (16 mm Vial)	0.0 to 32.6 mg/L (as P)	Vanadomolybdophosphoric Acid
Potassium	0.0 to 20.0 mg/L (as K)	Tetraphenylborate
Silica LR	0.00 to 2.00 mg/L (as SiO ₂)	Heteropoly Blue
Silica HR	0 to 200 mg/L (as SiO ₂)	EPA
Silver	0.000 to 1.000 mg/L (as Ag)	PAN
Sulfate	0 to 150 mg/L (as SO ₄ ²⁻)	Barium Chloride
Surfactants, Anionic	0.00 to 3.50 mg/L (as SDBS)	EPA 425.1
Surfactants, Anionic (16 mm Vial)	0.00 to 3.50 mg/L (as SDBS)	EPA 425.1
Surfactants, Cationic (16 mm Vial)	0.00 to 2.50 mg/L (as CTAB)	Bromophenol Blue
Surfactants, Nonionic (16 mm Vial)	0.00 to 6.00 mg/L (as TRITON X-100)	TBPE
Zinc	0.00 to 3.00 mg/L (as Zn)	Zincon

13. ACCESSORIES

13.1. Reagent Sets

Code	Description
HI736-25	25 phosphate marine ULR tests
HI755-26	25 alkalinity marine tests
HI758-26	25 calcium marine tests
HI764-25	25 nitrite marine ULR tests
HI775-26	25 alkalinity fresh water tests
HI93700-01	100 ammonia LR tests
HI93700-03	300 ammonia LR tests
HI93701-01	100 chlorine free tests (powder)
HI93701-03	300 chlorine free tests (powder)
HI93701-F	300 chlorine free tests (liquid)
HI93701-T	300 chlorine total tests (liquid)
HI93702-01	100 copper HR tests
HI93702-03	300 copper HR tests
HI93703-52	100 ozone tests
HI93704-01	100 hydrazine tests
HI93704-03	300 hydrazine tests
HI93705-01	100 silica LR tests
HI93705-03	300 silica LR tests
HI93707-01	100 nitrite LR tests
HI93707-03	300 nitrite LR tests
HI93708-01	100 nitrite HR tests
HI93708-03	300 nitrite HR tests
HI93709-01	100 manganese HR tests
HI93709-03	300 manganese HR tests
HI93710-01	100 pH tests
HI93710-03	300 pH tests
HI93711-01	100 chlorine total tests (powder)
HI93711-03	300 chlorine total tests (powder)
HI93712-01	100 aluminum tests
HI93712-03	300 aluminum tests

Code	Description
HI93713-01	100 phosphate LR tests
HI93713-03	300 phosphate LR tests
HI93715-01	100 ammonia MR tests
HI93715-03	300 ammonia MR tests
HI93716-01	100 bromine tests
HI93716-03	300 bromine tests
HI93717-01	100 phosphate HR tests
HI93717-03	300 phosphate HR tests
HI93718-01	100 iodine tests
HI93718-03	300 iodine tests
HI93719-01	100 hardness magnesium tests
HI93719-03	300 hardness magnesium tests
HI93720-01	100 hardness calcium tests
HI93720-03	300 hardness calcium tests
HI93721-01	100 iron HR tests
HI93721-03	300 iron HR tests
HI93722-01	100 cyanuric acid tests
HI93722-03	300 cyanuric acid tests
HI93723-01	100 chromium(VI) HR tests
HI93723-03	300 chromium(VI) HR tests
HI93726-01	100 nickel HR tests
HI93726-03	300 nickel HR tests
HI93728-01	100 nitrate tests
HI93728-03	300 nitrate tests
HI93729-01	100 fluoride LR tests
HI93729-03	300 fluoride LR tests
HI93730-01	100 molybdenum tests
HI93730-03	300 molybdenum tests
HI93732-01	100 dissolved oxygen tests
HI93732-03	300 dissolved oxygen tests
HI93731-01	100 zinc tests
HI93731-03	300 zinc tests
HI93733-01	100 ammonia HR tests

Code	Description
HI93733-03	300 ammonia HR tests
HI93735-01	100 hardness total MR tests (200 to 500 mg/L)
HI93735-02	100 hardness total HR tests (400 to 750 mg/L)
HI93735-0	300 hardness total tests (LR - 100 tests, MR - 100 tests, HR - 100 tests)
HI93735-00	100 hardness total LR tests (0 to 250 mg/L)
HI93737-01	50 silver tests
HI93737-03	150 silver tests
HI93738-01	100 chlorine dioxide tests
HI93738-03	300 chlorine dioxide tests
HI93739-01	100 fluoride HR tests
HI93739-03	300 fluoride HR tests
HI93740-01	50 nickel LR tests
HI93740-03	150 nickel LR tests
HI93746-01	50 iron LR tests
HI93746-03	150 iron LR tests
HI93748-01	50 manganese LR tests
HI93748-03	150 manganese LR tests
HI93749-01	100 chromium(VI) LR tests
HI93749-03	300 chromium(VI) LR tests
HI93750-01	100 potassium tests
HI93750-03	300 potassium tests
HI93751-01	100 sulfate tests
HI93751-03	300 sulfate tests
HI937520-01	50 magnesium tests
HI937520-03	150 magnesium tests
HI937521-01	50 calcium tests
HI937521-03	150 calcium tests
HI93753-01	100 chloride tests
HI93753-03	300 chloride tests
HI93754A-25	24 chemical oxygen demand EPA LR tests (Vial)
HI93754B-25	24 chemical oxygen demand EPA MR tests (Vial)
HI93754C-25	24 chemical oxygen demand HR tests (Vial)
HI93754D-25	24 chemical oxygen demand Hg Free LR tests (Vial)

Code	Description
HI93754E-25	24 chemical oxygen demand Hg Free MR tests (Vial)
HI93754F-25	24 chemical oxygen demand ISO LR tests (Vial)
HI93754G-25	24 chemical oxygen demand ISO MR tests (Vial)
HI93754J-25	24 chemical oxygen demand UHR tests (Vial)
HI93757-01	100 ozone tests
HI93757-03	300 ozone tests
HI93758A-50	50 phosphorus reactive LR tests (Vial)
HI93758B-50	50 phosphorus acid hydrolyzed tests (Vial)
HI93758C-50	50 phosphorus total LR tests (Vial)
HI93763A-50	49 phosphorus reactive HR tests (Vial)
HI93763B-50	49 phosphorus total HR tests (Vial)
HI93764A-25	25 ammonia LR tests (Vial)
HI93764B-25	25 ammonia HR tests (Vial)
HI93766-50	50 nitrate tests (Vial)
HI93767A-50	49 nitrogen total LR tests (Vial)
HI93767B-50	49 nitrogen total HR tests (Vial)
HI95747-01	100 copper LR tests
HI95747-03	300 copper LR tests
HI95761-01	100 chlorine total ULR tests
HI95761-03	300 chlorine total ULR tests
HI95762-01	100 chlorine free ULR tests
HI95762-03	300 chlorine free ULR tests
HI95769-01	40 surfactants anionic tests
HI96770-01	100 silica HR tests
HI96770-03	300 silica HR tests
HI95771-01	100 chlorine total UHR tests
HI95771-03	300 chlorine total UHR tests
HI96773-01	50 oxygen scavengers tests
HI96773-03	150 oxygen scavengers tests
HI96776-01	100 iron(II) tests
HI96776-03	300 iron(II) tests
HI96777-01	100 iron(II)/(III) tests
HI96777-03	300 iron(II)/(III) tests

Code	Description
HI96778-25	25 total iron tests (Vial)
HI96779-01	100 chlorine dioxide (rapid) tests
HI96779-03	300 chlorine dioxide (rapid) tests
HI96780-25	24 surfactants, nonionic tests (Vial)
HI96781-25	25 chromium VI/total tests (Vial)
HI96782-25	25 surfactants, anionic tests (Vial)
HI96783-25	25 nitrite LR tests (Vial)
HI96784-25	25 nitrite MR tests (Vial)
HI96785-25	25 surfactants, cationic tests (Vial)
HI96786-25	25 iron tests (Vial)

13.2. pH Electrodes

Code	Description
HI10530	Triple ceramic, double junction, low temperature glass, refillable pH electrode with conical tip and temperature sensor
HI10430	Triple ceramic, double junction, high temperature glass, refillable pH electrode with temperature sensor
HI11310	Glass body, double junction, refillable pH/temperature electrode
HI11311	Glass body, double junction, refillable pH/temperature electrode with enhanced diagnostics
HI12300	Plastic body, double junction, gel filled, non refillable pH/temperature electrode
HI12301	Plastic body, double junction, gel filled, non refillable pH/temperature electrode with enhanced diagnostics
HI10480	Glass body, double junction with temperature sensor for wine analysis
FC2320	Double junction, open reference, non refillable, electrolyte viscolene, PVDF body with conical tip, pH/temperature electrode
FC2100	Double junction, open reference, non refillable, electrolyte viscolene, glass body with conical tip, pH/temperature electrode
FC2020	Double junction, open reference, non refillable, electrolyte viscolene, PVDF body with conical tip, pH/temperature electrode

Note: The enhanced diagnostics information are not displayed by meter.

13.3. pH Solutions

BUFFER SOLUTIONS

Code	Description
HI70004P	pH 4.01 buffer sachet, 20 mL (25 pcs.)
HI70007P	pH 7.01 buffer sachet, 20 mL (25 pcs.)
HI70010P	pH 10.01 buffer sachet, 20 mL (25 pcs.)
HI7001L	pH 1.68 buffer solution, 500 mL
HI7004L	pH 4.01 buffer solution, 500 mL
HI7006L	pH 6.86 buffer solution, 500 mL
HI7007L	pH 7.01 buffer solution, 500 mL
HI7009L	pH 9.18 buffer solution, 500 mL
HI7010L	pH 10.01 buffer solution, 500 mL
HI8004L	pH 4.01 buffer solution in FDA approved bottle, 500 mL
HI8006L	pH 6.86 buffer solution in FDA approved bottle, 500 mL
HI8007L	pH 7.01 buffer solution in FDA approved bottle, 500 mL
HI8009L	pH 9.18 buffer solution in FDA approved bottle, 500 mL
HI8010L	pH 10.01 buffer solution in FDA approved bottle, 500 mL

ELECTRODE STORAGE SOLUTIONS

Code	Description
HI70300L	Storage solution, 500 mL
HI80300L	Storage solution in FDA approved bottle, 500 mL

ELECTRODE CLEANING SOLUTIONS

Code	Description
HI70000P	Electrode rinse sachet, 20 mL (25 pcs.)
HI7061L	General cleaning solution, 500 mL
HI7073L	Protein cleaning solution, 500 mL
HI7074L	Inorganic cleaning solution, 500 mL
HI7077L	Oil & fat cleaning solution, 500 mL
HI8061L	General cleaning solution in FDA approved bottle, 500 mL
HI8073L	Protein cleaning solution in FDA approved bottle, 500 mL
HI8077L	Oil & fat cleaning solution in FDA approved bottle, 500 mL

ELECTRODE REFILL ELECTROLYTE SOLUTIONS

Code	Description
HI7082	3.5M KCl electrolyte, 4x30 mL, for double junction electrodes
HI8082	3.5M KCl electrolyte in FDA approved bottle, 4x30 mL, for double junction electrodes

13.4. Other Accessories

Code	Description
HI72083300	Carrying case
HI731311	Vial cuvette 16 mm diam. (5 pcs.)
HI731318	Cloth for wiping cuvettes (4 pcs.)
HI731331	Glass cuvette (4 pcs.)
HI731335N	Cap for cuvette (4 pcs.)
HI731340	200 μ L automatic pipette
HI731341	1000 μ L automatic pipette
HI731342	2000 μ L automatic pipette
HI740034P	Cap for 100 mL beaker (10 pcs.)
HI740036P	100 mL plastic beaker (10 pcs.)
HI740038	60 mL glass bottle and stopper
HI740142P	1 mL graduated syringe (10 pcs)
HI740143	1 mL graduated syringe (6 pcs.)
HI740144P	Pipette tip (10 pcs.)
HI740157P	Plastic refilling pipette (20 pcs.)
HI740216	Cooling rack
HI740217	Safety shield for reactor
HI740220	25 mL graduated glass vial (2 pcs.)
HI740224	170 mL plastic beaker (12 pcs.)
HI740225	60 mL graduated syringe
HI740226	5 mL graduated syringe
HI740227	Filter assembly
HI740228	Filter disc (25 pcs.)
HI740229	100 mL graduated cylinder
HI74083300	COD Adapter
HI75110/220E	USB power adapter, European plug
HI75110/220U	USB power adapter, USA plug

Code	Description
HI76404A	Electrode holder
HI83399-11	CAL Check™ cuvette kit for HI83399
HI83300-100	Sample preparation kit consisting of activated carbon for 50 tests, demineralizer bottle for 10 L of water, 100 mL graduated beaker with cap, 170 mL graduated beaker with cap, 3 mL pipette, 60 mL syringe, 5 mL syringe, graduated cylinder, spoon, funnel, filter paper (25 pcs.)
HI839800-01	Reactor, European plug
HI839800-02	Reactor, USA plug
HI920015	USB to micro USB cable connector
HI93703-50	Cuvette cleaning solution (230 mL)
HI93703-55	Activated carbon (50 pcs.)

CERTIFICATION

All Hanna® instruments conform to the CE European Directives.



Disposal of Electrical & Electronic Equipment. The product should not be treated as household waste. Instead, hand it over to the appropriate collection point for the recycling of electrical and electronic equipment, which will conserve natural resources.

Disposal of waste batteries. This product contains batteries, do not dispose of them with other household waste. Hand them over to the appropriate collection point for recycling.

Ensuring proper product and battery disposal prevents potential negative consequences for the environment and human health. For more information, contact your city, your local household waste disposal service, or the place of purchase.



RECOMMENDATIONS FOR USERS

Before using this product, make sure it is entirely suitable for your specific application and for the environment in which it is used. Any variation introduced by the user to the supplied equipment may degrade the photometer's performance. For your and the meter's safety do not use or store the meter in hazardous environments.

WARRANTY

The HI83399 is warranted for two years against defects in workmanship and materials when used for its intended purpose and maintained according to instructions. This warranty is limited to repair or replacement free of charge. Damage due to accidents, misuse, tampering, or lack of prescribed maintenance is not covered.

If service is required, contact your local Hanna Instruments® office. If under warranty, report the model number, date of purchase, serial number (engraved on the bottom of the meter), and the nature of the problem. If the repair is not covered by the warranty, you will be notified of the charges incurred. If the meter is to be returned to Hanna Instruments, first obtain a Returned Goods Authorization (RGA) number from the Technical Service department and then send it with shipping costs prepaid. When shipping any meter, make sure it is properly packed for complete protection.

Hanna Instruments® reserves the right to modify the design, construction or appearance of its products without advance notice.

World Headquarters

Hanna Instruments Inc.
Highland Industrial Park
584 Park East Drive
Woonsocket, RI 02895 USA
www.hannainst.com



MAN83399

Printed in ROMANIA