

HI 83749

Turbidity & Bactocheck



INSTRUCTION MANUAL

Dear
Customer,

Thank you for choosing a Hanna Instruments product.

Please read this instruction manual carefully before using this meter.

This manual will provide you with the necessary information for correct use of this meter, as well as a precise idea of its versatility.

If you need additional technical information, do not hesitate to e-mail us at tech@hannainst.com or view our worldwide contact list at www.hannainst.com.

All rights are reserved. Reproduction in whole or in part is prohibited without the written consent of the copyright owner, Hanna Instruments Inc., Woonsocket, Rhode Island, 02895, USA.

TABLE OF CONTENTS

1. PRELIMINARY EXAMINATION 5

2. GENERAL DESCRIPTION 6

 2.1. BENTOCHECK 6

 2.2. TAG IDENTIFICATION SYSTEM 7

 2.3. ABBREVIATIONS 8

3. SPECIFICATIONS 9

4. FUNCTIONAL DESCRIPTION 10

 4.1. INSTRUMENT DESCRIPTION 10

 4.2. KEYPAD DESCRIPTION 10

 4.3. CONNECTORS DESCRIPTION 11

 4.4. DISPLAY DESCRIPTION 12

 4.5. BEEPER 12

5. GENERAL TIPS FOR AN ACCURATE MEASUREMENT 13

 5.1. CUVETTE 13

 5.2. CUVETTE HANDLING 13

 5.3. CUVETTE OILING 13

 5.4. SAMPLING TECHNIQUE 13

 5.5. REMOVING AIR BUBBLES 14

 5.6. MEASUREMENT TIPS 14

6. CALIBRATION PROCEDURE 15

 6.1. CALIBRATION 15

 6.2. OUT OF CALIBRATION RANGE FUNCTION 17

 6.3. CALIBRATION ERRORS 18

 6.4. DELETE CALIBRATION 18

7. TURBIDITY MEASUREMENT 19

 7.1. AVG (SIGNAL AVERAGE MODE) 20

 7.2. CONTINUOUS MEASUREMENT 20

8. BENTOCHECK (PROTEIN STABILITY TEST) 21

9. DETERMINATION OF BENTONITE REQUIREMENT 24

 9.1. SAMPLE PREPARATION 24

 9.2. READING PROCEDURE 26

 9.3. COMPARATIVE MODE 28

10. LOGGING 29

 10.1. VIEW LOGGED DATA 30

11. GOOD LABORATORY PRACTICE (GLP) 33

12. SETUP	35
12.1. SET REFERENCE VALUE	35
12.2. ACTIVATING COMPARATIVE MODE	36
12.3. SET EPA COMPLIANCE MODE	37
12.4. SET BEEPER	38
12.5. SHOW / HIDE THE TIME	38
12.6. SET THE DATE	39
12.7. SET THE TIME	40
12.8. SET INSTRUMENT ID	41
12.9. SET BAUD RATE	42
12.10. LCD BACKLIGHT	42
13. TAG INSTALLATION	43
14. LAMP REPLACEMENT	44
15. BATTERY MANAGEMENT	45
15.1. BATTERIES REPLACEMENT	46
15.2. USING AN AC ADAPTER	46
16. ERROR CODES	47
17. PC INTERFACE	48
18. ACCESSORIES	49
CERTIFICATION	50
RECOMMENDATIONS FOR USERS	50
WARRANTY	50

1. PRELIMINARY EXAMINATION

Remove the meter from the packing material and examine it carefully. For further assistance, please contact your local Hanna Instruments office or email us at tech@hannainst.co.

This HI83749 Turbidity & Bencotest Meter is supplied complete with:

- Six sample cuvettes and caps
- Four calibration cuvettes (HI83749-11)
- Bencotest reagent (HI83749-0) and Silicone oil (HI93703-58)
- One 1000 μ L automatic pipette with two tips and Instructions sheet
- Four 25 mL glass vials with caps
- One 1 mL syringe with two tips; one Funnel; Filter paper (25 pieces)
- Five tag holders with tags (HI920005)
- Tissue for wiping the cuvettes
- Four 1,5V AA batteries
- AC Adapter
- Instruction manual
- Instrument quality certificate
- Rugged carrying case

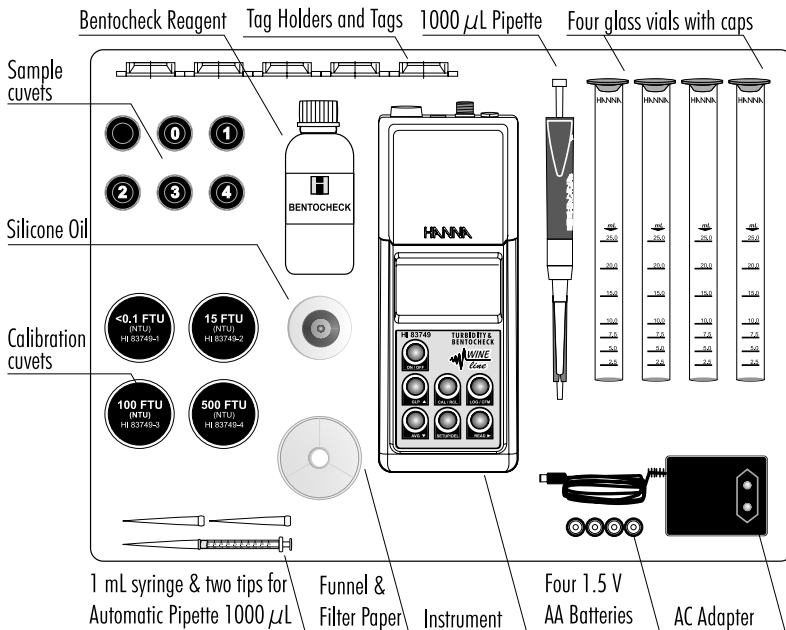

Note: Save all packing material until you are sure that the instrument works correctly. Any damaged or defective item must be returned in the original packing with the supplied accessories.

2. GENERAL DESCRIPTION

The **HI83749** is an auto diagnostic microprocessor meter that benefits from Hanna's years of experience as manufacturer of analytical instruments.

The meter is especially designed for wine analyses and, beside turbidity measurements, it allows to make tests to verify protein stability (e.g. Bencotest).

The instrument compensates wine color to guarantee accurate readings during the vinification process; also for the darkest red wine samples. The optical system, consisting of a tungsten filament lamp and multiple detectors, assures long term stability and minimizes the need of frequent calibration. Calibration can be anyway easily performed at any time in two, three or four points (<0.1, 15, 100 and 500 NTU-adjustable calibration points), using the supplied or user prepared standards.

The meter has all necessary GLP (Good Laboratory Practice) functions to allow maximum traceability of data like a real time clock, log-on-demand (up to 200 measurements), and T.I.S. -Tag Identification System to give all recorded data a location, time and date stamp.

The meter measures turbidity of samples from 0.00 to 1200 NTU (Nephelometric Turbidity Units) and is USEPA compliant. In the USEPA measurement mode the instrument rounds the readings to meet USEPA reporting requirements. It has a continuous measurement mode to verify the settling rate of suspended matter, and a signal average (AVG) mode to accumulate multiple readings giving a final average value. The AVG routine is particularly useful to measure samples with suspended particles with different dimensions.

The **HI83749** has a user-friendly interface, with a large backlit LCD (Liquid Crystal Display). Acoustic signals and displayed codes to guide the user step by step through routine operations.

This valuable splash proof portable turbidity meter is supplied in a rigid carrying case that offers protection for harsh environments.

2.1. BENCOTEST

The prevention of protein haze or deposit in bottled white wines is a universal concern and often a wine needs to be stabilized before bottling. One commonly used stabilization agent is bentonite. Bentonite is a volcanic clay earth type fining agent (like kaolin). It improves the clarity and stability of wine but has also negative aspects because of the volume of lees formed, reduction of tannin and color. Since there are different types and qualities of bentonite with different capacity of protein removal, it is important to make laboratory trials with the same lot and wetting degree of the bentonite as that will be used in the cellar.

Protein stabilization is normally not a problem in bottled red wines because of the relatively high concentration of phenols that binds and precipitates with the instable proteins before bottling. Often bentonite is added to red wines at a level of about 12 g/hL (1 lb/1000 gal), reducing colloidal suspended particles thus improving membrane filterability.

Wines with low phenols contents, such as rose, light reds and whites should be checked for protein stability before bottling. Hanna is offering a rapid test to verify the risk of future protein haze formation.

If protein instability is detected, a next test can help defining the right amount of bentonite to be added for improving protein stability. It is important not to overdose bentonite, avoiding stripping wine flavour, body, and significant loss of color, especially in young red wines. Moreover, adding only the necessary amount of bentonite to obtain the desired protein stability is also costs saving.

2.2. TAG IDENTIFICATION SYSTEM

Hanna is the first manufacturer of turbidity instruments that has decided to add the unique T.I.S. - Tag Identification System to portable turbidity meters, to meet the more restrictive needs for traceability and data management of our clients.

The system is designed for scientific and industrial applications, or to prove during safety audits and inspections that samples have been truly taken on pre-established locations.

The system is as easy to install as to operate. Just fix the so-called iButton® tags near your sampling sites that need to be checked often, and with this the T.I.S. is setup. The tag contains a computer chip embedded in a durable stainless steel can. It is designed to withstand the harsh environments, indoors or outdoors. The number of tags that can be installed is practically unlimited, because each tag has a unique identification code.

Immediately after installation of the tags you can start collecting data. Use the meter to take measurements and memorize the test result by pressing the Log-on-Demand key. Then, the instrument will ask for the tag identification. Simply touching the iButton® with the matching connector on the meter does identify and authenticate logging, by storing the iButton® serial number, time and date stamp events.

The power of the T.I.S. features resides in the PC application. Download all test data to your PC and use our HI92000 Windows® compatible application software for further data management. You can sort or filter all your collected data on different criteria like on a specific sampling location, parameter, date and time intervals, or fix range to filter measured values. The data can be plotted in a graph, exported to other common Windows® applications or printed for reporting purpose.

It is also possible to add new tags later on, thus increasing an already existing database. Each time the PC software recognizes a not already registered tag, it will ask for a description of the new sampling location.

2.3. ABBREVIATIONS

NTU	Nephelometric Turbidity Units
FTU	Formazin Turbidity Units
USEPA	US Environmental Protection Agency
LCD	Liquid Crystal Display
RTC	Real Time Clock
T.I.S.	Tag Identification System

iButton® is registered Trademark of "MAXIM/DALLAS semiconductor Corp."

Windows® is registered Trademark of "MICROSOFT Corporation"

A light beam that passes through the sample is scattered in all directions. The intensity and pattern of the scattered light is affected by many variables like wavelength of the incident light, particle size, shape, refractive index and color.

The optical system includes a tungsten filament lamp, a scattered light detector (900) and a transmitted light detector (1800). The microprocessor of the instrument calculates the NTU value from the signals that reaches the two detectors.

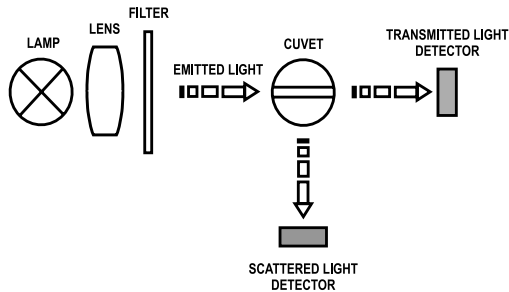

3. SPECIFICATIONS

Range	0.00 to 9.99 NTU 10.0 to 99.9 NTU 100 to 1200 NTU
Range Selection	Automatically
Resolution	0.01 NTU from 0.00 to 9.99 NTU 0.1 NTU from 10.0 to 99.9 NTU 1 NTU from 100 to 1200 NTU
Accuracy	$\pm 2\%$ of reading plus 0.05 NTU
Repeatability	$\pm 1\%$ of reading or 0.02 NTU, whichever is greater
Stray Light	< 0.05 NTU
Light Source	Tungsten filament lamp
Light Detector	Silicon Photocell
Method	Ratio Nephelometric Method.
Display	60 x 90mm backlit LCD
Calibration	Two, three or four points calibration
LOG Memory	200 records
Serial Interface	RS232 or USB 1.1
Environment	0 to 50°C (32 to 122°F); max 95% RH non-condensing
Power supply	4 x 1.5V AA alkaline batteries or AC adapter
Auto Shut-off	After 15 minutes of non-use
Dimensions	224 x 87 x 77 mm (8.8 x 3.4 x 3.0")
Weight	512 g (18 oz.)

4. FUNCTIONAL DESCRIPTION

4.1. INSTRUMENT DESCRIPTION

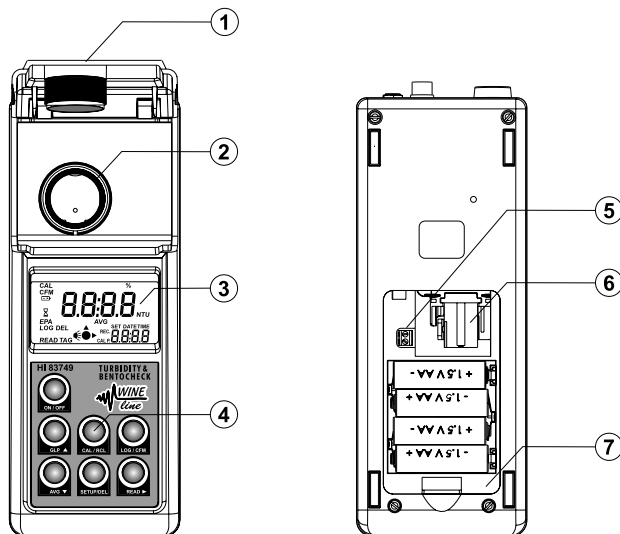

1. Cuvette lid
2. Cuvette holder
3. Backlit Liquid Crystal Display (LCD)
4. Splash proof keypad
5. Lamp connector
6. Lamp holder
7. Battery compartment

4.2. KEYPAD DESCRIPTION

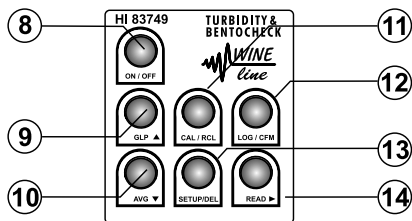

8. ON/OFF - press to turn the instrument ON or to activate the back light. Keep the key pressed for three seconds to turn the instrument OFF.

9. GLP - press to enter/exit GLP (Good Laboratory Practice) feature. In Setup this key is used to increase the set values. In Log Recall it is used to select a new record (scroll up).
10. AVG - press to select the AVG (Signal Average Mode) on and off. In Setup it is used to decrease the set values. In Log Recall it is used to select a previous record (scroll down).
11. CAL/RCL - press to enter/exit calibration or in setup mode to start/stop editing a parameter. Hold the key for 3 seconds to enter/exit viewing log content.
12. LOG/CFM - press to save a record or to confirm the selected option.
13. SETUP/DEL - press to enter/exit setup. The DEL function is available in Log Recall mode to delete one or all records. In GLP it is used to restore factory calibration.
14. READ - press to start a measurement. Hold the key to make a continuous measurement. In Log Recall mode it is used to view the content of a record. In GLP it is used to view all available information. In Setup, during date or time editing, it is used to select day, month or year and hour/minutes.

4.3. CONNECTORS DESCRIPTION

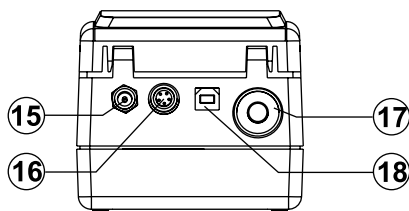

15. AC adapter connector
16. RS232 connector, to be used with serial cable to transfer data to PC
17. Tag reader
18. USB connector

4.4. DISPLAY DESCRIPTION

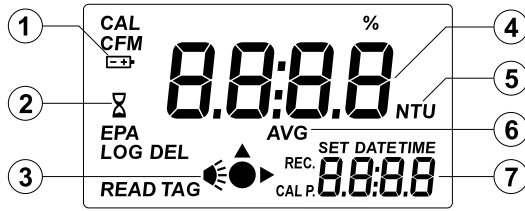

1. Battery icon is displayed when the battery voltage is getting low.
2. Hourglass icon is displayed when the instrument performs an internal checkup.
3. Lamp and read status indicator.
4. Main LCD display
5. NTU measurement units. When average or continuous mode is selected, the “NTU” tag blinks for each new displayed value. For conversions in other units see Measurement Units section.
6. AVG icon is displayed when the Signal Average Mode is selected.
7. Secondary LCD display

4.5. BEEPER

A long beep indicates an error or an invalid key pressed. A short beep indicates that current operation is confirmed.

5. GENERAL TIPS FOR AN ACCURATE MEASUREMENT

The instructions listed below should be carefully followed to ensure best accuracy.

- Always cap the cuvettes to avoid spillage of the sample into the instrument.
- Always close the lid of the instrument during measurement.
- Keep the lid of the instrument closed when not in use to prevent dust or dirt entering.
- Place the instrument on a flat, rugged surface when taking measurements.

5.1. CUVETTE

The cuvette is part of the optical system and measurements can be affected by the glass imperfections, dirt, dust, scratches, or fingerprints present on its surface.

5.2. CUVETTE HANDLING

- Any cuvette with visible scratches must be discarded.
- Always store the cuvettes in separate boxes or with separators between them to avoid scratches.
- Whenever a cuvette is placed into the instrument, it must be dry outside, free of fingerprints or dirt. Wipe it thoroughly with [HI731318](#) (tissue for wiping cuvettes, see Accessories Section) or a lint-free cloth prior to insertion.

5.3. CUVETTE OILING

- For low turbidity readings (<1.0 NTU) the cuvettes should be oiled outside with the supplied [HI93703-58](#) Silicone oil. Use only one single drop of oil and then wipe the cuvette thoroughly with a lint-free cloth.

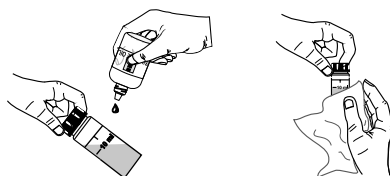

5.4. SAMPLING TECHNIQUE

When taking turbidity measurements it is important to take a representative sample.

- Gently mix the sample before filling the cuvette.
- Samples should be analyzed immediately after collection because turbidity can settle or change in time.
- Pay attention when working with cold samples that no condense is formed on the outside of the cuvette. We recommend to work with samples at room temperature.

5.5. REMOVING AIR BUBBLES

Air bubbles present in the sample will cause erroneous high-turbidity readings.

- To remove air bubbles fill the cuvette with wine sample and tighten the cap. Shake the cuvette gently to create pressure. Allow the cuvette to stand for a few minutes and gently invert it several times. Check that no air bubbles are visible, otherwise shake again and repeat the procedure above.
- Alternatively use an ultrasonic bath to degas the wine sample.

5.6. MEASUREMENT TIPS

- For a correct filling of the cuvette: the liquid in the cuvet forms a convexity on the top; the bottom of this convexity must be at the same level of the 10 mL mark.
- For dosing the Bencotcheck reagent, we recommend to use the supplied Hanna automatic pipette (HI731341 - 1000 μL).
- For correct use of Hanna automatic pipette, please follow the related Instruction Sheet.

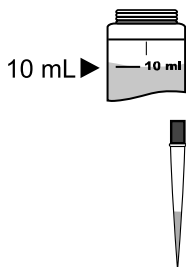

- In order to measure the exact volume of bentonite suspension with the 1 mL syringe, push the plunger completely into the syringe and insert the tip into the solution. Pull the plunger up to above the 0.0 mL mark. Take out the syringe and clean the outside of the syringe tip. Then, adjust the plunger to the 0.0 mL mark (the lower edge of the seal must be exactly on the 0.0 mL mark). Ensure no drops are hanging on the tip of the syringe, if so wipe the tip clean. Next, to add exactly 0.25 mL of bentonite suspension, keep the syringe in vertical position over the cylinder and push the plunger down until the lower edge of the seal is exactly on the 0.25 mL mark. The exact amount of 0.25 mL has now been added to the cylinder, even if the tip still contains some solution. Repeat the entire procedure to measure 0.50 mL, 0.75 mL and 1 mL of bentonite suspension.

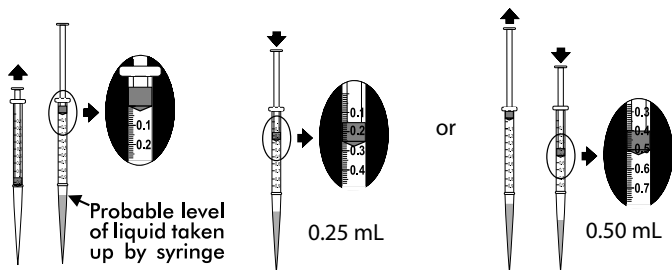

6. CALIBRATION PROCEDURE

It is recommended to calibrate the meter only with Hanna ready-to-use calibration standard solutions. Alternatively, formazin standards can be used. The prepared formazin solutions should be close to the default calibration points. The first point must be close to 0 NTU, the second point between 10 and 20 NTU, the third point between 50 and 150 NTU and the fourth point between 400 and 600 NTU.

6.1. CALIBRATION

Calibration can be performed in two, three or four points. To stop the calibration procedure press ON/OFF button.

- Turn the instrument ON by pressing ON/OFF. When the LCD displays “----”, the instrument is ready.

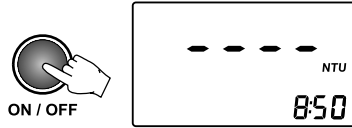

- Enter calibration mode by pressing CAL/RCL. The display will show “CAL P.1”

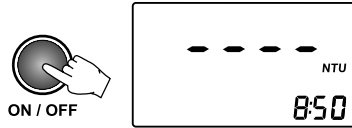

- Place the <math><0.10</math> NTU standard cuvette into the holder.

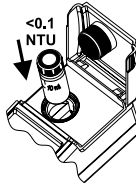

- Close the lid and press READ ► “----” and the “Lamp and Read Status” indicator will blink on the display. Alternatively, press LOG/CFM to skip the first calibration point.

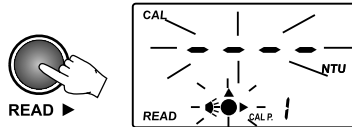

- Then the LCD will show the second calibration point (15.0 NTU) and “CAL P.2”, while “READ” is blinking.

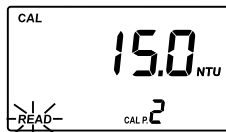

Note: If you're using different calibration standards, change the displayed value by pressing UP or DOWN keys until the display shows the desired value.

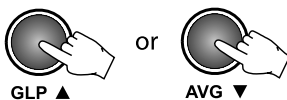

- Remove the <0,10 NTU standard cuvette and place the 15.0 NTU standard cuvette into the holder.

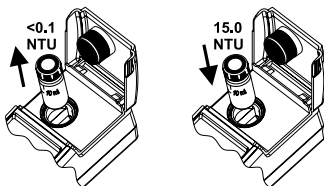

- Close the lid and press READ ► “----” and the “Lamp and Read Status” indicator will blink again while making the reading.

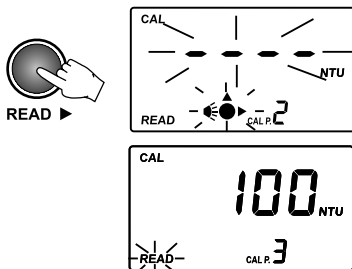

- At the end of the reading, the third calibration point (100 NTU) and “CAL P.3” is displayed. If desired, the value can be changed using the UP or DOWN keys.

Note: Press CAL/RCL to exit calibration. The instrument will memorize the two-point (<0.10 and 15.0 NTU) calibration data and will return to measurement mode.

- Remove the 15.0 NTU standard cuvette from the meter and place the 100 NTU standard cuvette into the holder.

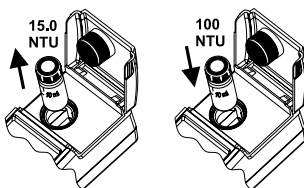

- Close the lid and press READ ► “----” and the “Lamp and Read Status” indicator will blink again while making the reading. At the end of the reading, the fourth calibration point

(500 NTU) and "CAL P.4" is displayed. If desired, the value can be changed using the UP or DOWN keys.

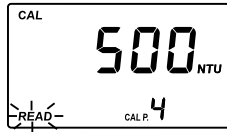

Note: Press CAL/RCL to exit calibration. The instrument will memorize the three-point (<0.10, 15.0 and 100 NTU) calibration data and will return to measurement mode.

- Remove the 100 NTU standard cuvette from the meter and insert the 500 NTU standard cuvette into the holder.

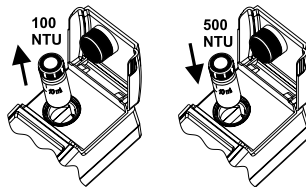

- Close the lid and press READ ► "----" and the "Lamp and Read Status" indicator will blink again while making the reading.

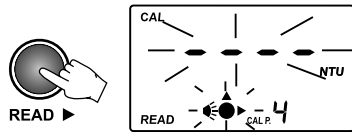

- At the end of the measurement, the four-point calibration is completed and the instrument returns automatically to measurement mode.

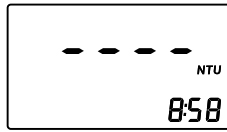

6.2. OUT OF CALIBRATION RANGE FUNCTION

The instrument has an Out Cal Range function to alert the user (with "CAL" blinking message) when taken measurement is outside the calibration range.

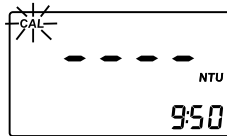

6.3. CALIBRATION ERRORS

- If the read value during calibration is too far from the set value, the instrument will show “-LO-” or “-HI-” error.

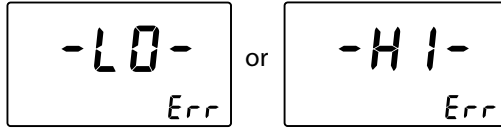

- If the calculated calibration coefficients are outside specifications, the “CAL Err” message is displayed.

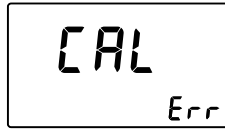

6.4. DELETE CALIBRATION

HI83749 is factory calibrated. It is possible to restore factory calibration by deleting last performed calibration.

To delete last calibration, follow the next steps:

- Enter the GLP feature by pressing GLP. The date of the last calibration will be displayed on the LCD (e.g. 2019.02.23).



- Press READ ► to scroll through the information related to calibration. The last panel is the one with “Delete Calibration”.

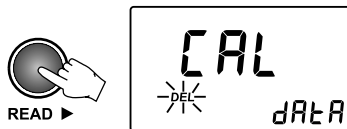

- Press SETUP/DEL to delete the current calibration. After deletion the instrument will automatically return to measurement mode and the factory calibration is restored.

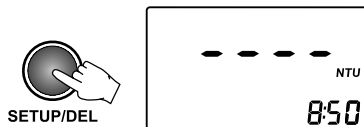

7. TURBIDITY MEASUREMENT

Note: For wine analysis it is recommended to always work with the AVG mode on.

- Press ON/OFF to turn the instrument on.
- When the LCD displays "----", the instrument is ready for measurement. The current time appears on the secondary LCD, if selected in Setup menu.

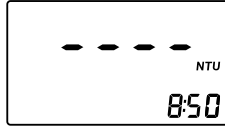

- Fill a clean, dry cuvette with 10 mL of wine up to the mark, taking care to handle the cuvette by the top. Replace the cap.

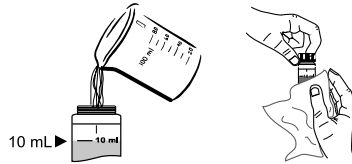

Note: To remove any fingerprints or dirt, wipe the cuvette thoroughly with a lint-free cloth. If necessary, apply HI93703-58 Silicone oil (see General tips for an accurate measurements), recommended only if low turbidity values need to be read.

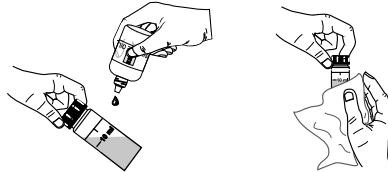

- Insert the cuvette into the instrument and close the lid.

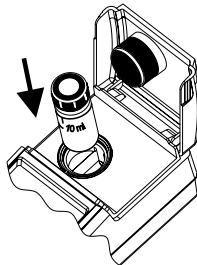

- Press READ▶ and “----” will blink on the display.

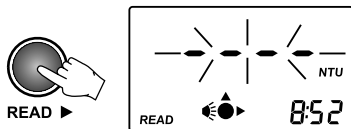

- At the end of the measurement, the instrument directly displays turbidity in NTU.

7.1. AVG (SIGNAL AVERAGE MODE)

It is recommended to select this measurement mode when you work with unstable samples that contain suspended particles of different dimensions.

In the AVG mode the instrument takes 20 measurements over a short period of time and displays the updated averaged value.

To select the averaged measurement mode press the AVG▼ key and the AVG icon will appear on the LCD.

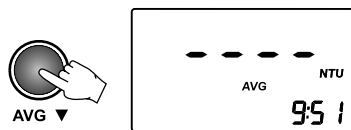

Note: to return to the normal measurement mode just press again the AVG▼ key.

Press READ▶ and “----” will blink on the display. After a few seconds the instrument displays the first reading. The meter continues updating the readings until the “Lamp and Read Status” indicator turns off. The final displayed value is the averaged reading of turbidity in NTU.

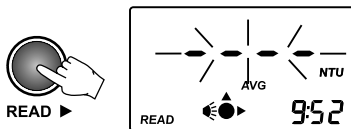

7.2. CONTINUOUS MEASUREMENT

This measurement mode can be used to verify how fast suspended parts settle out. Please verify that the AVG mode is turned off (see instructions above). To make continuous measurement keep the READ▶ key pressed until the desired number of measurements are taken.

The last value remains on the display after the READ▶ key has been released.

8. BENTOCHECK (PROTEIN STABILITY TEST)

- Turn the instrument ON by pressing ON/OFF. When the LCD displays “----”, the instrument is ready.

Note: On the secondary LCD the current time appears, if selected in Setup menu.

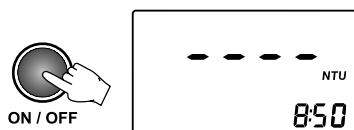

- Select the AVG mode by pressing the AVG ▼ key. The AVG icon will appear on the display.

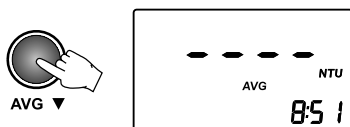

- Fill a clean, dry cuvette with 10 mL of wine up to the mark, taking care to handle the cuvette by the top. Replace the cap and wipe the cuvette thoroughly with a lint-free cloth (see General tips for an accurate measurement).

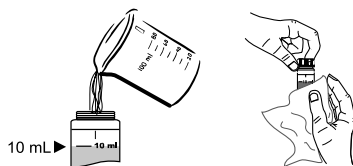

- Place the cuvette into the instrument and close the lid.

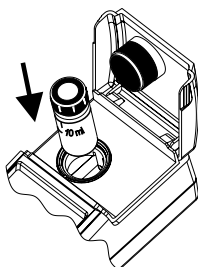

- Press READ ► and “----” will blink on the display. After a few seconds the instrument displays the first reading. The meter continues updating the readings until the “Lamp and Read Status” indicator turns off. The final displayed value is the averaged reading.

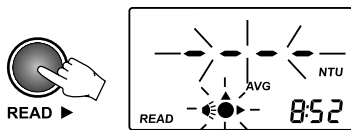

- At the end of the measurement, the instrument directly displays turbidity in NTU. This is T1. Record the value.

e.g. T1

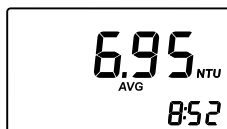

- Use the 1000 μ L automatic pipette to add exactly 1 mL of **HI83749-0** Bencotcheck reagent to the cuvette. For a correct use of the automatic pipette please follow the related Instruction Sheet.

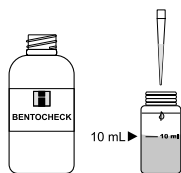

- Replace the cap. Invert several times to mix and then wait for 1 minute.

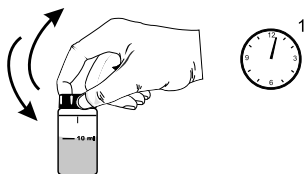

- Insert the cuvette into the instrument and close the lid.

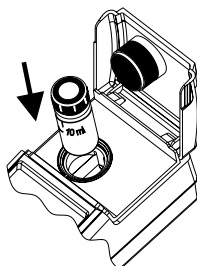

- Press READ▶ and “----” will blink on the display. After a few seconds the instrument displays the first reading. The meter continues updating the readings until the “Lamp and Read Status” indicator turns off.

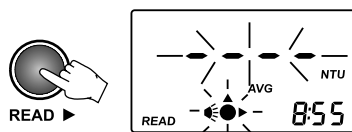

- The final displayed value is the averaged reading of turbidity in NTU. This is T2. Record the value.

e.g. T2



- If “ $T2 < T1 + 2$ ” the wine can be considered stable. Otherwise the wine needs to be stabilized.

Note: to get more representative results of long term protein stability, HANNA Instruments® recommends to filter the wine sample first through a 0.45 micron filter disc before analysis.

9. DETERMINATION OF BENTONITE REQUIREMENT

9.1. SAMPLE PREPARATION

- Fill four HANNA vials with 25 mL of unfiltered wine sample.

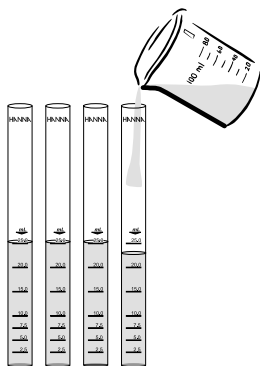

- Prepare a bentonite suspension of 2.5%.

Note: Always use a bentonite suspension with the same wetting degree as the suspension that is used in production.

- Use the 1 mL syringe to add 0.25 mL of bentonite suspension to the vial #1; then add 0.50 mL to #2, 0.75 mL to #3 and 1 mL to #4.

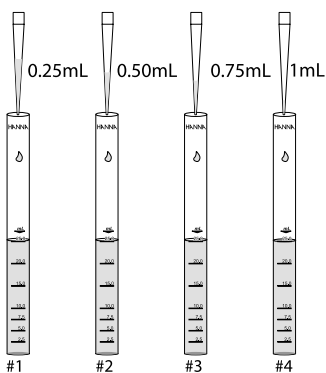

Note: in order to measure the exact volume of bentonite suspension with the syringe, follow the instructions on page 13.

- Close the glass vials tightly with their caps and mix thoroughly.

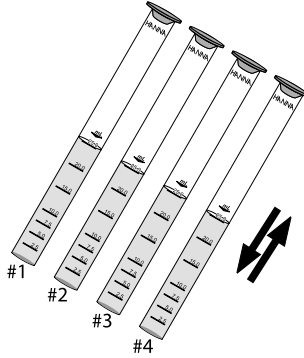

- Wait for 15 minutes to allow suspended matter to settle.
- Fold a filter disc twice as shown in the figure.
- Separate one side from the other three to form a cone. Insert the folded filter disc in the funnel.

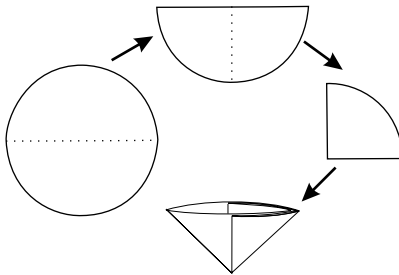

- Decant off clear liquid and filter the treated wine from vial #1 into cuvette #1 to collect 10 mL of filtered sample. Place the cap #1 and wipe the cuvette thoroughly with a lint-free cloth (see General Tips for an accurate measurements).

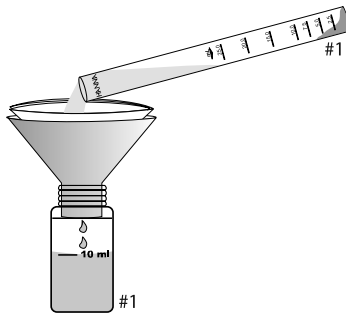

- Prepare fresh filters and repeat the filtration for all treated wine samples (#2, #3, #4).

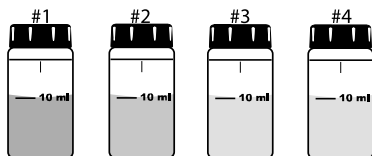

9.2. READING PROCEDURE

- Turn the instrument ON by pressing ON/OFF. When the LCD displays “----”, the instrument is ready.
- Select the AVG mode by pressing the AVG ▼ key. The AVG icon will appear on the display.

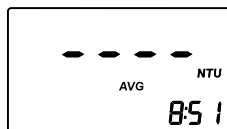
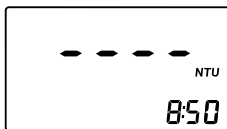

- Place the cuvette #1 into the instrument and close the lid. Press READ ► and “----” will blink on the display. After a few seconds the instrument displays the first reading. The meter continues updating the readings until the “Lamp and Read Status” indicator turns off.

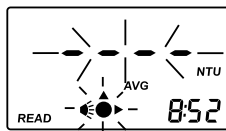
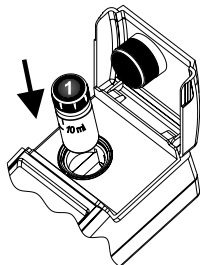

- The final displayed value is the averaged reading. This is T1 for sample #1. Record the value.

e.g. Sample #1

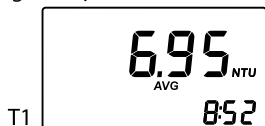

- Remove cuvette #1 and open the cap. Use the 1000 μL automatic pipette to add exactly 1 mL of [HI83749-0](#) Bencotcheck reagent to the cuvette. For a correct use of the automatic pipette please follow the related Instruction Sheet.

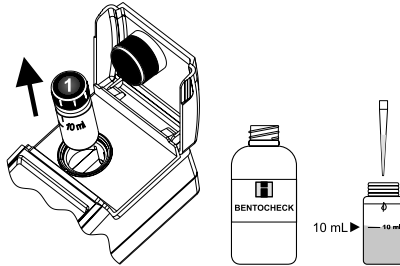

- Replace the cap. Invert several times to mix and wait for 1 minute.

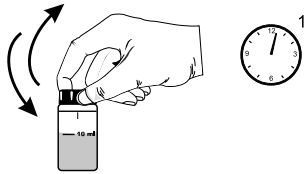

- Insert the cuvette into the instrument and close the lid. Press READ \blacktriangleright and "----" will blink on the display. After a few seconds the instrument displays the first reading. The meter continues updating the readings until the "Lamp and Read Status" indicator turns off.

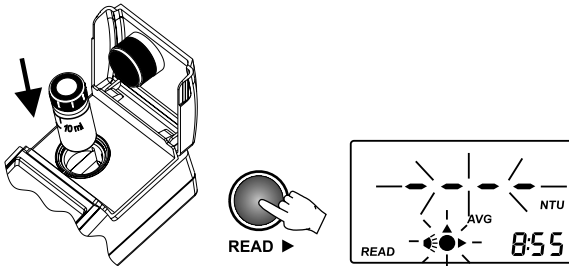

- The final displayed value is the averaged reading of turbidity in NTU. This is T2. Record the value.

e.g. sample #1



- Repeat the reading procedure for all samples (#2, #3, #4) and record all T1 and T2 values.
- For each sample verify if “ $T2 < T1 + 2$ ”: if so, the wine can be considered stabilized. Compare the results. It is recommended to choose the lowest dosage of bentonite necessary to stabilize the wine.
- To define the g/hL of bentonite to be added to the wine tank, just multiply by 100 the mL of 2,5% bentonite suspension that was added to the HANNA vial (0.25 mL for vial #1, 0.50 mL for #2, 0.75 mL for #3 and 1.00 mL for #4):

Bentonite requirement in g/hL = mL of bentonite added with syringe x 100

	# 1 (0.25 mL)	# 2 (0.50 mL)	# 3 (0.75 mL)	# 4 (1.00 mL)
T1	6.95	6.05	5.62	5.10
T2	10.4	8.60	7.50	6.40
T2 < T1 + 2	no	no	yes	yes

For this example, 0.75 mL is the lowest bentonite dosage necessary to stabilize the wine sample. Now just multiply the mL for 100 ($0.75 \times 100 = 75$ g/hL) to obtain the bentonite requirement.

9.3. COMPARATIVE MODE

An alternative mode of measurement is Comparative Mode. It is possible to set a reference value (T1) and let the instrument automatically compare turbidity values. See SETUP section.

10. LOGGING

HI83749 has a log space for up to 200 records. With each measurement, the date, time and tag ID is stored. In this way, each record is fully characterized and can be easily analyzed when downloading data on the PC application (HI92000).

The log function is active after a valid measurement is obtained (no errors).

- To log a value, press LOG/CFM when the measurement result is displayed. The instrument asks to READ TAG for identification of the sampling location. The location for the new record is also displayed on the secondary LCD.

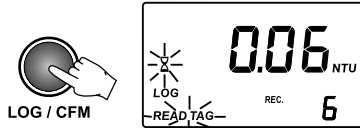

- To read the ID code for the sampling location identification, simply touch the iButton® tag with the matching connector, located on the back of the instrument (see Connectors description). Alternatively, press again LOG/CFM to store the record without the tag ID code.

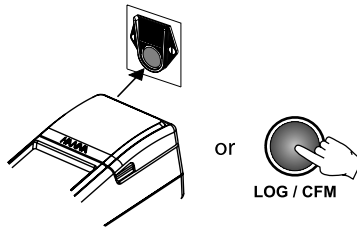

- If the tag is successfully read, the instrument will beep once, displaying the unique hexadecimal code of the tag, and store the data. After data is stored, the instrument returns to measurement mode.

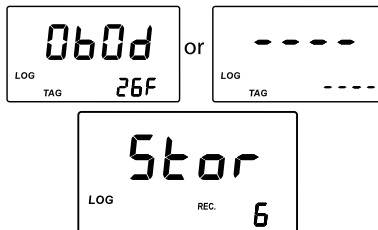

Notes: If the tag is not read within 20 seconds, the logging procedure is canceled. A measurement can be stored only once. Also an over range value can be stored.

- If there are less than ten available records, the “LOG” tag will blink while storing data.

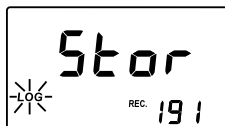

- If the log memory is full, the “LoG FULL” message will appear for a few seconds on the LCD and the instrument will return to measurement mode without storing the new record.



To store a new record, delete one or more records.

10.1. VIEW LOGGED DATA

The stored records can be viewed at any moment by keeping CAL/RCL key pressed for a few seconds. To return to normal measurement mode, press RCL again .



Log Searching

The log records are stored in chronological order. The first displayed record is the last stored one.

- Press UP or DOWN keys to scroll the log memory record by record. By keeping pressed the UP or DOWN keys, the scrolling speed will increase.

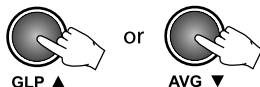

- The scrolling of the log is possible from any panel of the record, except “Delete last log” and “Delete all logs” panels.
- When scrolling the log, the number of the record is displayed for one second on the secondary LCD together with “TAG” if the identification of the sampling location was made.

When the log is full, an error beep is heard.

Record Viewing

Each record contains more information than the measured value. The additional information is grouped in several panels.

Press READ▶ to scroll through the record panels. The record panels are displayed one by one in a circular way.



Each record contains the following panels:

- The record value (turbidity value) and record number.



- The hexadecimal string of the tag for the sampling location ID.



Note: If the logged sample value is an over range reading, the maximum value (1200) will be displayed blinking.

Note: If the ID data are missing, “—” is displayed instead.

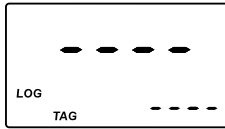

- Measurement date in YYYY.MM.DD format.



- Measurement time in hh:mm format.

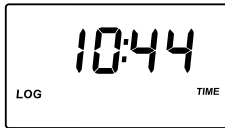

- Delete the last record panel (only for last record).

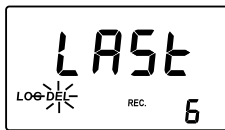

- Delete all records.



Delete Last Record

To delete the last record, scroll through the log menu until the delete last record panel is displayed.

- To delete the last record, press SETUP/DEL when the “Delete last records” panel is displayed.

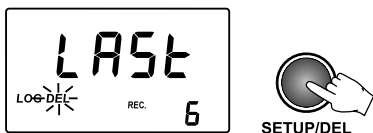

- The instrument asks for confirmation. Press the LOG/CFM key to confirm the last record is deleted. To abort the delete function, press READ▶ instead of LOG/CFM.

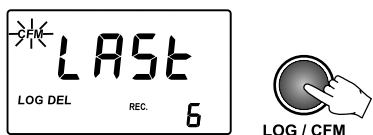

- After the record is deleted, the instrument goes immediately to the first panel of the previous record. If the log becomes empty, “----” will be displayed for one second and the instrument will return to measurement mode.



Delete All Records

To delete all records, scroll through the log until delete all records panel is displayed.

- To delete all records press SETUP/DEL when the “Delete all records” panel is displayed.



- The instrument asks for confirmation. Press the LOG/CFM key to confirm all records are deleted. To abort the delete function, press READ▶ instead of LOG/CFM.



- After all records are deleted the instrument returns to measurement mode.

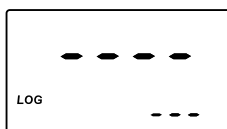

11. GOOD LABORATORY PRACTICE (GLP)

The GLP feature allows the user to view last calibration data. Also the user calibration can be deleted.

- Press GLP ▲ to enter or exit GLP data consulting. Several functions are available when in GLP menu. Press READ ► to scroll through the GLP data.



The following GLP panels can be viewed.

- The last calibration date, in YYYY.MM.DD format. If no calibration was performed, the factory calibration message, "F.CAL", will be displayed on the LCD.

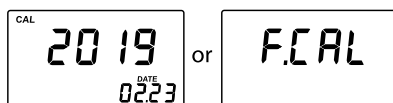

- The time of the last calibration in hh:mm format.

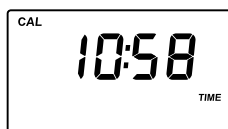

- First calibration point: 0.00 NTU if skipped or the actual read value (e.g. 0.01 NTU).

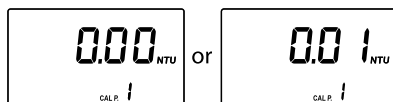

- Second calibration point.

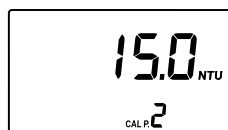

- Third calibration point (if available).



- Fourth calibration point (if available).



- Delete calibration panel.



To delete calibration: press SETUP/DEL when the instrument displays the “Delete calibration” panel. The user calibration will be deleted and the factory calibration will be restored. The instrument will enter automatically in idle mode.



12. SETUP

The Setup mode allows the user to view and modify the instrument parameters.

The blinking "CAL" tag appears during setup mode suggesting to press CAL for editing parameters.

- To enter/exit SETUP, press SETUP/DEL.



- To select the parameter to be edited, press UP or DOWN keys until the desired panel is displayed.

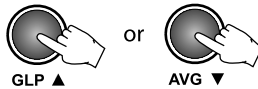

12.1. SET REFERENCE VALUE

During determination of bentonite requirement for stabilization of the wine, it can be useful to set a reference value and let the instrument automatically compare turbidity values.

- When the display shows the first reading (T1), you can store the result as Reference Value. Press SETUP/DEL to enter the "Set Reference Value" panel. "CAL" will blink and "SET rEF" will be displayed.

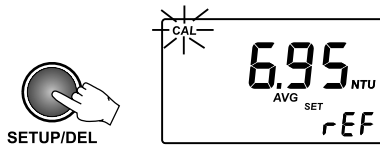

- To set the reference value, press CAL/RCL. Then the value and "CFM" tag will start blinking.

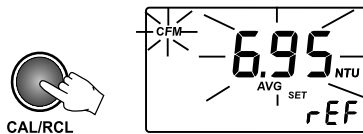

- At this point the displayed reference value can be modified using the UP and DOWN arrow keys.

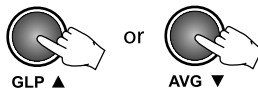

- Press LOG/CFM to store the value.



Note: To exit without saving the reference value, press **SETUP/DEL** and the meter will return to the measurement panel.

- To activate the Comparative mode, press the **AVG ▼** key and set ON the Comparative mode.

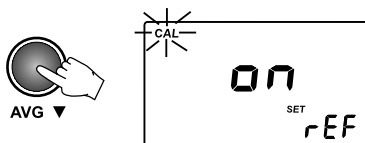

- Press **SETUP/DEL** to return to Measurement mode. The display will show the reference value.



- Add **HI83749-0** Benticheck reagent, mix and wait for 1 minute. Then take a new reading (T2).
- If the difference between T1 and T2 is less than 10%, the instrument gives a beep of 1 second and displays alternating the turbidity value (NTU) and the difference (%).

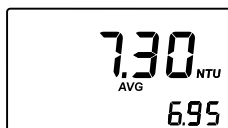

alternating with

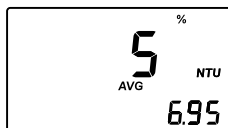

- If the difference between T1 and T2 is more than 10%, the instrument just displays T2 on the primary LCD and T1 on the secondary LCD.

12.2. ACTIVATING COMPARATIVE MODE

For the determination of bentonite requirement you can activate Comparative mode for an automatic comparison of turbidity values.

- To edit the Comparative mode, press **CAL/RCL** when “Activating Comparative mode” panel is displayed. The parameter setting and “CFM” tag will start blinking.



- Press the UP or DOWN keys to set the Comparative mode on or off.

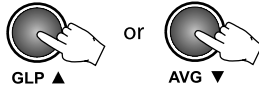

- Press LOG/CFM to save the setting. The new selected option will be displayed on the LCD. Alternatively, press CAL/RCL to exit without saving the new settings.

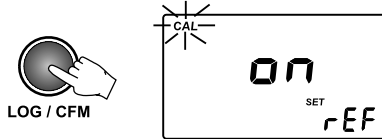

Note: when Comparative mode is set on, in the Measurement mode, the secondary display will show the reference value



12.3. SET EPA COMPLIANCE MODE

When EPA compliance reading is on, “EPA” message is displayed on the secondary LCD and the reported values are rounded to meet EPA reporting requirements.

To edit the EPA mode, press CAL/RCL when EPA compliance reading panel is displayed. The parameter setting and “CFM” tag will start blinking.



Press the UP or DOWN keys to set the EPA compliance mode on or off.

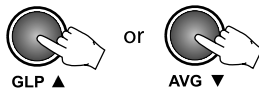

Press LOG/CFM to save the setting. The new selected option of the parameter will be displayed on the LCD. Alternatively, press CAL to exit without saving the new settings.

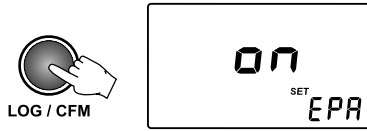

12.4. SET BEEPER

The HI83749 has a built-in beeper that signals the read tag, the pressed key and the error conditions. The beeper can be selected to be on or off.

- To set the beeper on or off, press CAL/RCL when set beeper panel is displayed. The beeper status and the CFM tag will start blinking.

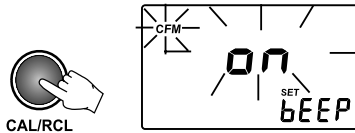

- Press the UP or DOWN keys to set the beeper on or off.

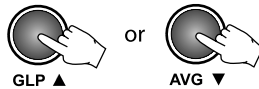

- Press LOG/CFM to save the change. The new selected option will be displayed on the LCD. Alternatively, press CAL to exit without saving the changes.

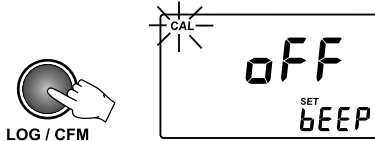

12.5. SHOW / HIDE THE TIME

You can choose between showing or hiding the current hour and minutes on the secondary LCD.

- To set hiding or showing the time, press CAL/RCL when the "Show/hide time" panel is displayed. The time show status and the CFM tag will start blinking.

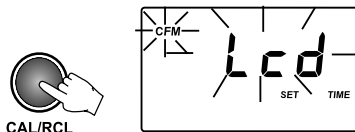

- Press the UP or DOWN keys to set LCD / hide for time.

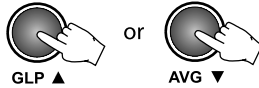

- Press LOG/CFM to save the change. The new selected option will be displayed on the LCD. Alternatively, press CAL/RCL to exit without saving the changes.

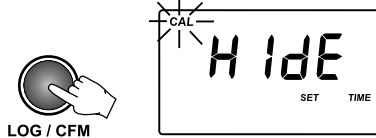

12.6. SET THE DATE

The HI83749 turbidimeter has a built-in real time clock (RTC). The RTC time is used to generate a unique time stamp for each recorded value and to automatically store the last calibration date. The current time can be displayed on the LCD when the instrument is in measurement mode.

- To set the current date, press CAL/RCL when the “Set date” panel is displayed. The date format is YYYY.MM.DD. The last two digits of the year value and CFM tag will start blinking.

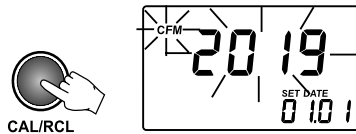

- Press the UP or DOWN keys to set the year value.

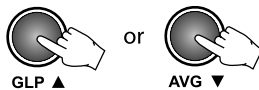

- Press LOG/CFM or READ▶ to start editing the month value. The month value will start blinking.

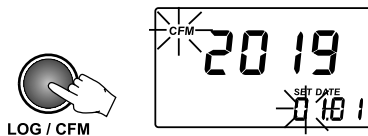

- Press the UP or DOWN keys to set the month value.

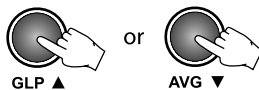

- Press LOG/CFM or READ▶ to start editing the day value. The day value will start blinking.

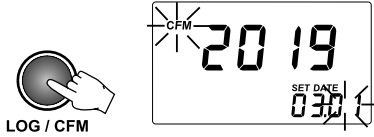

- Press the UP or DOWN keys to set the day value.

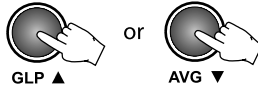

Note: to edit the year again, after the day was set, press READ▶.

- Press LOG/CFM to save the new date. The new date will be displayed on the LCD. Alternatively, press CAL/RCL to exit without saving the changes.

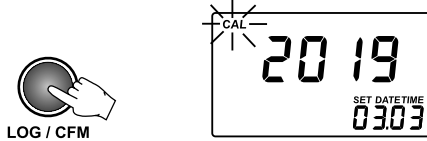

12.7. SET THE TIME

- To set the current time, press CAL/RCL when the “Set time” panel is displayed. The time format is hh:mm. The time value and “CFM” tag will start blinking.

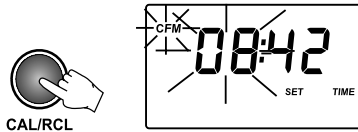

- Press the UP or DOWN keys to set the hour value.

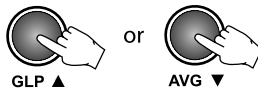

- Press LOG/CFM or READ▶ to start editing the minutes. The minutes value will start blinking.

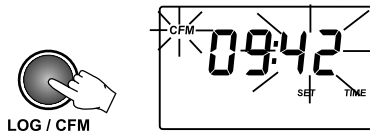

- Press the UP or DOWN keys to set the minutes value.

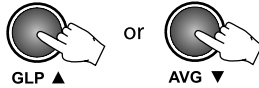

Note: To edit the hour again, after the minutes were edited, press READ▶.

- Press LOG/CFM to save the new time. The new set time will be displayed. Alternatively, press CAL/RCL to exit without saving the changes.

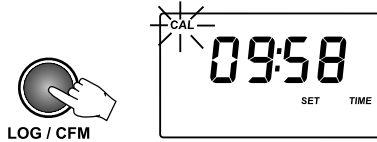

12.8. SET INSTRUMENT ID

The instrument ID is a four digit number that can be edited by the user. The instrument ID is downloaded on the PC application, together with the logged data. By setting a different ID for each instrument it is possible to mix information from different turbidimeters into the same database.

- To set the instrument ID, press CAL/RCL when the “Set instrument ID” panel is displayed. The default instrument ID is 0000. The existing ID value and the CFM tag will start blinking.

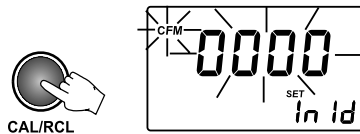

- Press the UP or DOWN keys to set the new instrument ID. By pressing and holding the UP or DOWN keys, the changing speed will increase.

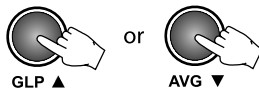

- Press LOG/CFM to save the change. The new instrument ID will be displayed. Alternatively, press CAL/RCL to exit without saving the changes.

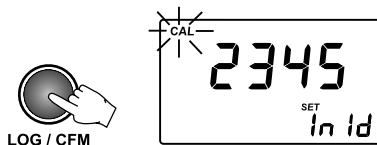

12.9. SET BAUD RATE

The HI83749 has a RS232 and a USB link. When the USB connection is used, the RS232 connection becomes inactive. To successfully communicate with the PC, the same baud rate must be selected on the instrument and on the PC application. The available baud rates are 1200, 2400, 4800 and 9600.

- To set the baud rate, press CAL/RCL when the “Set baud rate” panel is displayed. The parameter value and the CFM tag will start blinking.

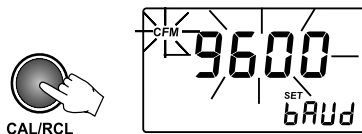

- Press the UP or DOWN keys to select the new baud rate value.

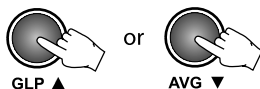

- Press LOG/CFM to save the change. The new selected baud rate will be displayed. Alternatively, press CAL/RCL to exit without saving the changes.

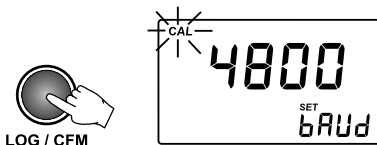

12.10. LCD BACKLIGHT

The LCD can be illuminated to allow the user to see the readings even in dark environments.

To turn on or off the backlight, press the ON/OFF key. The backlight will automatically shut-off after 25 seconds of non-use to save the battery life.



13. TAG INSTALLATION

The tag is housed in a rugged metal that can withstand harsh environments. However, it is better to protect the tag from direct rain.

Place the tag near a sampling point. Fix it securely with the provided screws, in such a way that the metallic iButton® is easily accessible for reading the tag.

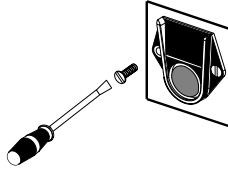

The number of tags that can be installed is practically unlimited. Additional tags can be ordered - see Accessories section ([HI920005](#) - five tag holders with tags).

14. LAMP REPLACEMENT

The instrument tungsten lamp has a life longer than 100,000 measurements. In case of lamp failure, the defective lamp can be easily replaced. When the lamp is broken, the instrument displays “no L” error message.

To replace the lamp follow the next steps:

- Remove the battery lid.
- Unscrew the lamp connection using a screwdriver.
- Unlock the lamp and extract it by pulling it out from the lamp holder handler.
- Place the new lamp in the right position and push it until is securely locked.
- Insert the lamp leads into the connector and tighten them using a screwdriver.

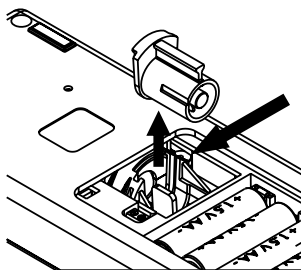

Warning: After lamp replacement the meter needs to be recalibrated.

15. BATTERY MANAGEMENT

For field measurements, HI83749 is powered by four AA batteries. The battery life is enough for 1500 normal measurements.

When you turn the instrument on, the remaining battery life is estimated and reported in percents.

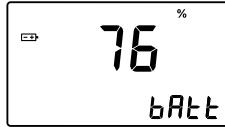

To save the battery life, the instrument will turn off after 15 minutes of non use. The backlight will be turned off after 25 seconds since the last key was pressed.

The battery life is measured each time the lamp is turned on and if the remaining battery life is less than 10%, the battery tag will blink on the LCD to advise the user to replace the batteries.

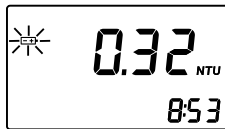

When the batteries are completely discharged, "0% bAtt" message will be displayed for one second and the instrument will turn off.

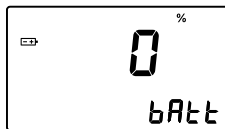

In order to use the instrument again, replace the batteries or use an AC adapter.

15.1. BATTERIES REPLACEMENT

To replace the batteries follow the next steps:

- Turn OFF the instrument by pressin ON/OFF.
- Open the batteries cover by pressing the locking clip.
- Take out the used batteries and insert four new 1.5 AA size batteries, paying attention to the correct polarity as indicated on the battery compartment.
- Replace the cover and press it until it locks.

Warning: Replace batteries only in a non-hazardous area.

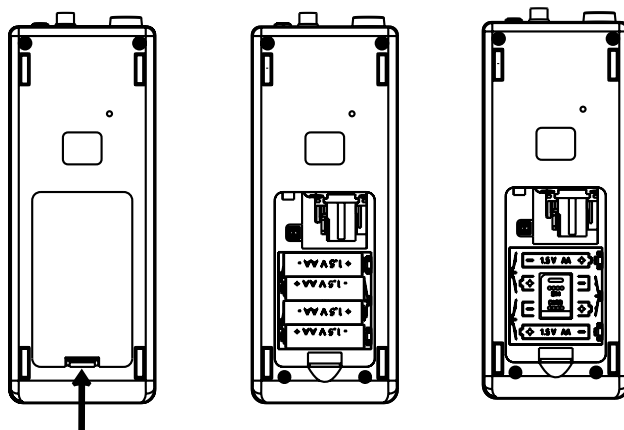

15.2. USING AN AC ADAPTER

In laboratory you can use an AC adapter to power the [HI83749](#). Simply connect the AC adapter to the instrument (see Connectors Description).

It is not necessary to turn the instrument off when connecting the external adapter.

Note: The connection to the external adapter will not recharge the batteries.

16. ERROR CODES

HI83749 has a powerful diagnostic system. Common errors are detected and reported for easy diagnostic and maintenance.

ERROR	DESCRIPTION	ACTION
Err1 – Err3; Err6; Err7; Err8	Critical errors. The instrument beeps and shuts down.	Contact your nearest HANNA Customer Service Center
Err4	The instrument beeps shortly twice and shuts down after 10 seconds.	Press simultaneously UP and DOWN to reset
CAP	The lid is not closed.	Close the lid. If the error persists, contact your nearest HANNA Customer Service Center
no L	Lamp broken or no light.	Check the optical system for obstructions. Replace the lamp.
L Lo	Not enough light.	Check the optical system for obstructions.
-LO	The standard used for current calibration point is too low.	Check the standard and use the correct one.
-HI	The standard used for current calibration point is too high.	Check the standard and use the correct one.
Battery tag blinking	The remaining battery life is too low.	Replace batteries.
bAtt	The batteries are too discharged for correct measurements.	Replace batteries.

17. PC INTERFACE

To fully use the instrument tag identification system function, the measured data has to be downloaded to a computer. The instrument can use RS232 or USB connection to communicate with the PC.

When using the RS232 protocol, simply connect a [HI920011](#) serial cable between the instrument and the computer.

To use the USB protocol, simply connect a regular USB cable between instrument and PC.

In both cases, the PC must run the [HI92000](#) application for successful data transfer.

To allow our users access to the latest version of Hanna Instruments PC compatible software, we made the products available for download at <http://software.hannainst.com>. Select the product code and click **Download Now**. After download is complete, use the **setup.exe** file to install the software.

18. ACCESSORIES

HI83749-20	Bentocheck (100 mL)
HI93703-58	Silicone oil (15 mL)
HI83749-11	Calibration cuvettes kit
HI731331	Glass cuvettes (4 pcs.)
HI731335N	Caps for cuvettes (4 pcs.)
HI93703-50	Cuvette cleaning solution (230 mL)
HI731318	Tissue for wiping cuvettes (4 pcs.)
HI740220	25 mL glass vial with cap (2 pcs.)
HI731341	Automatic pipette 1000 μ L
HI731351	Tips fo automatic pipette 1000 μ L (25 pcs.)
HI740233	Filter paper type II (100 pcs.)
HI740142P	1 mL graduated syringe (10 pcs.)
HI740144P	Tips for 1 mL syringe (10 pcs.)
HI740234	Replacement lamp for EPA turbidimeter (1 pcs.)
HI92000	Windows® compatible software
HI920011	RS232 connection cable
HI920005	5 tag holders with tags
HI740027P	1.5V AA battery (12 pcs)
HI710005	Voltage adapter from 115V to 12 VDC (USA plug)
HI710006	Voltage adapter from 230V to 12 VDC (European plug)
HI710012	Voltage adapter from 240V to 12 VDC (UK plug)
HI710013	Voltage adapter from 230V to 12 VDC (South Africa plug)
HI710014	Voltage adapter from 230V to 12 VDC (Australia plug)

CERTIFICATION

All Hanna Instruments conform to the CE European Directives.



Disposal of Electrical & Electronic Equipment. The product should not be treated as household waste. Instead hand it over to the appropriate collection point for the recycling of electrical and electronic equipment which will conserve natural resources.

Disposal of waste batteries. This product contains batteries, do not dispose of them with other household waste. Hand them over to the appropriate collection point for recycling. Ensuring proper product and battery disposal prevents potential negative consequences for the environment and human health. For more information, contact your city, your local household waste disposal service, the place of purchase or go to www.hannainst.com.



RECOMMENDATIONS FOR USERS

Before using this meter, make sure it is entirely suitable for your specific application and for the environment in which it is used. Any variation introduced by the user to the supplied equipment may degrade the meter's performance. For yours and the meter's safety do not use or store the meter in hazardous environments. HI 83749 is warranted for two years against defects in workmanship and materials when used for its intended purpose and maintained according to instructions. This warranty is limited to repair or replacement free of charge.

WARRANTY

HI83749 is warranted for two years against defects in workmanship and materials when used for its intended purpose and maintained according to instructions. This warranty is limited to repair or replacement free of charge. Damage due to accidents, misuse, tampering or lack of prescribed maintenance is not covered. If service is required, contact the dealer from whom you purchased the instrument. If under warranty, report the model number, date of purchase, serial number and the nature of the failure. If the repair is not covered by the warranty, you will be notified of the charges incurred. If the instrument is to be returned to Hanna Instruments, first obtain a Returned Goods Authorization number from the Technical Service Department and then send it with shipping costs prepaid. When shipping any instrument, make sure it is properly packed for complete protection. To validate your warranty, fill out and return the enclosed warranty card within 14 days from the date of purchase.

Hanna Instruments reserves the right to modify the design, construction or appearance of its products without advance notice.

World Headquarters

Hanna Instruments Inc.
Highland Industrial Park
584 Park East Drive
Woonsocket, RI 02895 USA
www.hannainst.com



MAN83749

Printed in ROMANIA