

# HI84531

## Total Alkalinity Mini Titrator & pH Meter for Water Analysis

# INSTRUCTION MANUAL



Dear  
Customer,

Thank you for choosing a Hanna Instruments product.

Please read this instruction manual carefully before using this instrument.

This manual will provide you with the necessary information for correct use of this instrument, as well as a precise idea of its versatility.

If you need additional technical information, do not hesitate to e-mail us at [tech@hannainst.com](mailto:tech@hannainst.com) or view our worldwide contact list at [www.hannainst.com](http://www.hannainst.com).

*All rights are reserved. Reproduction in whole or in part is prohibited without the written consent of the copyright owner, Hanna Instruments Inc., Woonsocket, Rhode Island, 02895, USA.*

## TABLE OF CONTENTS

1. Preliminary Examination .....	4
2. Specifications .....	5
3. General Description & Intended Use .....	7
4. Principle of Operation .....	9
5. Functional Description .....	10
6. Titrator Startup .....	13
7. Setup Menu .....	14
8. Guide to Display Codes .....	19
8.1. Pump Calibration Messages .....	20
8.2. pH Calibration Messages .....	21
8.3. Titration Messages .....	22
9. Electrode Preparation .....	23
10. Electrode Calibration Procedure .....	24
11. pH Buffer Temperature Dependence .....	28
12. Dosing Pump Installation .....	29
13. Dosing Pump Prime Procedure .....	30
14. Pump Calibration Procedure .....	32
15. Titration Procedure .....	36
15.1. Tips for an Accurate Measurement .....	39
15.2. View/Delete Titrator Recorded Data .....	39
15.3. Titrator GLP Information .....	41
16. pH Measurement .....	42
16.1. View/Delete Recorded pH Data .....	43
16.2. pH Meter GLP Information .....	44
17. PC Interface & Data Transfer .....	45
18. Electrode Conditioning & Maintenance .....	46
19. Troubleshooting Guide .....	47
20. Accessories .....	49
Certification .....	50
Recommendations for Users .....	50
Warranty .....	50

## 1. PRELIMINARY EXAMINATION

Remove the instrument and accessories from the packaging and examine it carefully. For further assistance, please contact your local Hanna Instruments Office or email us at [tech@hannainst.com](mailto:tech@hannainst.com).

The HI84531 mini titrator is supplied with:

- HI1131B pH electrode
- HI7662-T Temperature probe
- HI84531-70 Reagent kit for titratable alkalinity in water
- HI7082 Electrode fill solution
- 100 mL beaker (2 pcs.)
- Dosing pump valve
- 5 mL syringe
- 2000  $\mu$ L automatic pipette with two plastic tips
- 20 mL beaker (2 pcs.)
- Tube set (aspiration tube with titrant bottle cap and dispensing tube with tip)
- Stir bar
- Power adapter
- Instrument quality certificate
- Instruction manual

**Note:** Save all packing material until you are sure that the instrument works correctly. Any damaged or defective item must be returned in its original packing material with the supplied accessories.

## 2. SPECIFICATIONS

Titrator	Range	Low Range (LR): 30.0 - 400.0 mg/L CaCO <sub>3</sub> 0.6 - 8.0 meq/L CaCO <sub>3</sub> High Range (HR): 300 - 4000 mg/L CaCO <sub>3</sub> 6.0 - 80.0 meq/L CaCO <sub>3</sub>
	Resolution	LR: 0.1 mg/L / 0.1 meq/L HR: 1 mg/L / 0.1 meq/L
	Accuracy	LR: ± 1 mg/L or 3% of reading @ 25 °C whichever is greater HR: ± 10 mg/L or 3% of reading @ 25 °C whichever is greater
	Sample volume	50 mL
	Titration method	Acid-base titration
	Principle	Endpoint titration pH 4.50 or pH 8.30
	Pump speed	10 mL/min
	Stirring speed	600 rpm
	Log data	Up to 200 samples
	pH Meter	Range
Resolution		0.1 pH / 0.01 pH
Accuracy		± 0.01 pH
Calibration		1, 2 or 3 calibration points; 4 available buffers (4.01, 7.01, 8.30, 10.01)
Temperature compensation		Manual or automatic
mV Meter	Range	-2000.0 to 2000.0 mV
	Resolution	0.1 mV
	Accuracy	± 1.0 mV
	Log data	Up to 200 samples (pH or mV)
Temperature	Range	-20.0 to 120.0 °C (-4.0 to 248.0 °F)
	Resolution	0.1 °C
	Accuracy	± 0.4 °C without probe error

	Electrode	HI1131B
	Temperature probe	HI7662-T
Other Specifications	Environment	0 to 50 °C (32 to 122 °F); max 95% RH non-condensing
	Power supply	12 Vdc power adapter
	Dimensions	235 x 200 x 150 mm (9.2 x 7.9 x 5.9")
	Weight	1.9 kg (67.0 oz.)

### Required Reagents

HI84531-50	Low Range Titrant
HI84531-51	High Range Titrant
HI84531-55	Calibration Standard

### 3. GENERAL DESCRIPTION & INTENDED USE

The **H184531** is an affordable, easy to use, microprocessor-based automatic mini titrator and pH meter designed for the rapid and accurate analysis of Total Titratable Alkalinity in water. By eliminating subjective factors including color indicators, errors in mathematical calculations or erratic titrant additions from the measurement, this meter will quickly become a valuable analysis tool for water and wastewater.

The meter benefits from Hanna Instruments' many years of experience as a manufacturer of quality analytical instrumentation. A clear and well-designed user interface makes the meter intuitive and simple to use.

The meter employs a powerful and effective built-in algorithm to analyze the pH response to determine the exact pH endpoint, then uses this to make the necessary calculations.

By simply pressing the **Start** key in Titrator mode, the instrument will automatically titrate the sample to the endpoint. The current pH and temperature are continuously displayed during titration process.

The concentration is instantaneously displayed in selected measurement units on the large dot matrix display, then the instrument is ready for another titration by pressing the **Restart** key.

A dedicated **HELP** key aids in setup, calibration, status and troubleshooting.

Other features

- pH meter / mV meter
- Stir speed control
- Data can be stored using the log feature and then exported to a USB stick or transferred to a PC using the USB connection
- Log on demand for up to 400 samples (200 for pH measurements; 200 for titration results)
- GLP feature, to view calibration data for pH electrode and pump

#### Significance of Use

Alkalinity is an important parameter for control and treatment of water (surface, drinking and wastewater) it is indication of the water's buffering capacity or its ability to resist pH change.

Low alkalinity signifies that the water is susceptible to pH change, while high alkalinity indicates that the water is able to resist a major change in pH.

Alkalinity is primarily a result of the carbonate ( $\text{CO}_3^{2-}$ ), bicarbonate ( $\text{HCO}_3^-$ ) and hydroxide ( $\text{OH}^-$ ) concentration in water. However alkalinity concentrations include all contributions from borate, phosphates, silicates, and other base species present.

Water samples are subject to interferences including:

- Dissolved gases that contribute to alkalinity are lost or gained during sampling, transport or storage, these gases can include carbon dioxide.
- Oily matter, suspended solids, precipitated and other waste matter can coat the glass electrode causing a slow response time.

The **HI84531** mini titrator uses a method based on Standard Methods for the Examination Water and Wastewater. Standard Methods refers two types of alkalinity:

1. Strong Alkalinity or Phenolphthalein Alkalinity is typically determined by a titration to pH 8.3.
2. Total Alkalinity or Bromocresol Green Alkalinity is typically determined by a titration to pH 4.5.

The water sample is titrated until a fixed pH endpoint (4.5 or 8.3), the endpoint is determined by the potentiometric input.



## 4. PRINCIPLE OF OPERATION

Water alkalinity determinations are based on the neutralization of all basic species contained in the sample by titration with an acid:

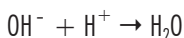

In an ideal solution, the endpoint of an alkalinity titration corresponds stoichiometrically to the complete neutralization of all the bases present. Due to the complex sample matrix, titrations are typically performed to a fixed pH endpoint. Two types of alkalinity can be determined based on the selected endpoint Total Alkalinity (pH 4.5) or Strong Alkalinity (pH 8.3). The endpoint can be determined visually using a color indicator (i.e. phenolphthalein or bromocresol green), however this endpoint can become objective depending on the analysts. The [HI84531](#) removes this issue by titrating to a fixed pH endpoint (4.5 or 8.3) determined by the user. The concentration can vary significantly with the selected pH endpoint. For precise analysis the sample size, volume of titrant added and titrant concentration must be known.

The [HI84531](#) Total Alkalinity Mini Titrator utilizes a simple sample preparation, a high quality dosing pump for titrant additions, potentiometric endpoint determination and instantaneous computations. To maintain the high accuracy of the mini titrator a simple pump calibration is required. The pump calibration uses a known quantity of a known solution to compensate for changes in the dosing system, this procedure should be performed regularly.

## 5. FUNCTIONAL DESCRIPTION

### Front View

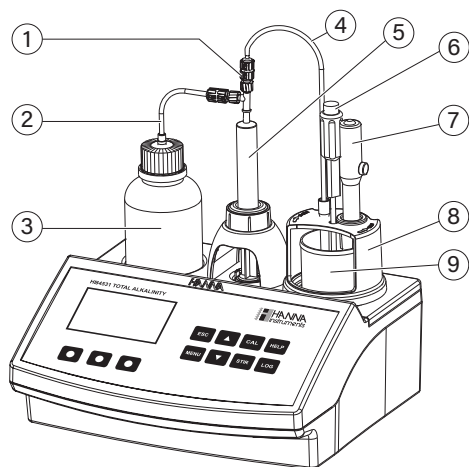

1. Dosing pump valve
2. Aspiration tube
3. Titrant bottle
4. Dispensing tube
5. Syringe
6. Temperature probe
7. pH electrode
8. Electrode holder
9. Beaker

### Top View

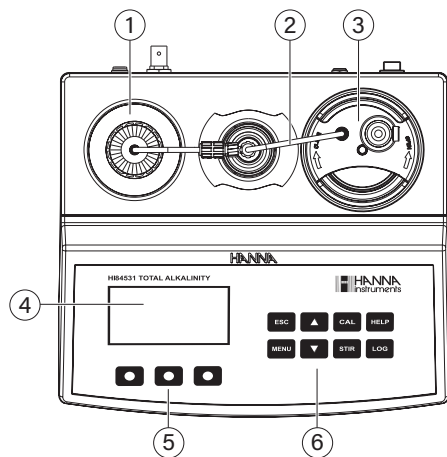

1. Titrant bottle
2. Dispensing tube
3. Electrode holder
4. Liquid Crystal Display (LCD)
5. Functional keys
6. Keypad

## Rear View

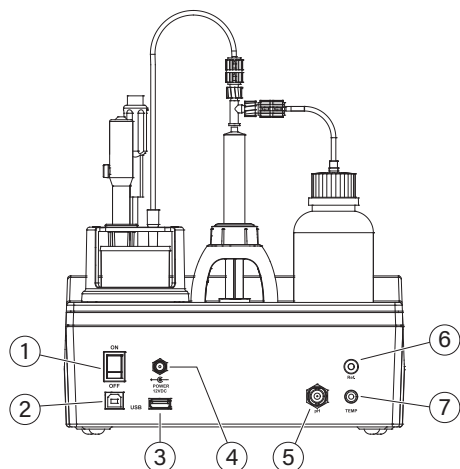





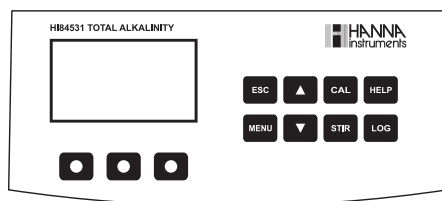



1. Power switch
2. USB connector (PC interface)
3. USB connector (storage interface)
4. Power adapter
5. BNC electrode connector
6. Reference electrode connector
7. Temperature probe connector

## Keypad Description



The keypad contains 8 direct keys and 3 functional keys with the following functions:

-  Press the functional key to select the virtual option displayed above it on the LCD.
-  Press **ESC** key to leave the current screen and to return either to the previous screen or to the main screen. In Setup menu, exits a parameter without changing the value.
-  Press **ARROW** keys to modify parameter values, scroll through help screens or move between Setup options
-  Press **CAL** key to access the Electrode and Pump calibration options
-  Press **HELP** key to access/exit the instrument's contextual help
-  Press **LOG** key to save the current mV/pH reading in pH meter mode and the titration result
-  Press **MENU** key to enter Setup, Recall or GLP selection menu, while instrument is in pH or Titration mode
-  Press **STIR** key to start/stop the stirrer

*Note: The stirrer starts automatically during pump calibration and titration, it cannot be stopped by pressing STIR key.*

## Display Indicators

During the instrument's operation information is displayed on the LCD.

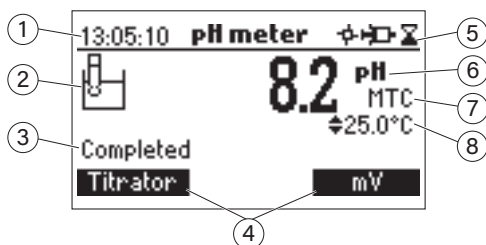

1. Current time and instrument mode information (pH meter or Titrator)
2. pH electrode condition
3. Instrument status
4. Virtual option keys
5. Stirrer and reading status
6. Main reading information
7. pH temperature compensation mode (Manual or Automatic)
8. Temperature reading

Displayed icons:

- ✦ Stirrer running (blinks when stirrer is not working properly.)
- ☞ Pump running
- ⚡ Unstable reading
- ⚙ Parameter can be modified

## Dosing Pump

The dosing pump is based on a valve that automatically moves the titrant between the titrant bottle and syringe when filling the syringe and between the syringe and sample when dispensing. A replaceable 5 mL plastic syringe is used to limit the amount of titrant used per test to ensure the highest possible accuracy. Before a set of titrations, it is necessary to prime the dosing system.

**Note:** *Once titrations have been completed, the dosing system should be cleaned with deionized water using the prime feature.*

## 6. TITRATOR STARTUP

This is a general outline of the steps required to perform a titration. The following topics are expanded upon each section that follows.

- Place the instrument on a flat table. Do not place the instrument in direct sun light.
- Connect the power adapter to the instrument.
- Turn the instrument on using the power switch from the rear panel of the instrument.
- Set up the instrument. See the SETUP MENU section for details.
- Connect the pH electrode to the instrument.
- Connect the temperature sensor to the instrument.
- Calibrate the pH electrode.
- Connect the tubes and the valve. See the DOSING PUMP INSTALLATION section for the procedure.
- Remove the titrant bottle cap and replace it with the bottle cap with tubes. Place the titrant bottle in the appropriate place on the titrator top.

**Note:** *Different titrants are required based on the concentration. See PUMP CALIBRATION PROCEDURE for details.*

- Prime the syringe. To assure high accuracy, verify there are no air bubbles in the syringe or tubing.
- Calibrate the pump.

**Note:** *Different volumes of standard are required based on the concentration. See TITRATION PROCEDURE section for details.*

- Prepare the sample.
- Run a titration and log sample results.

## 7. SETUP MENU

The titrator's setup menu may be accessed from the main screen (meter or titrator) by pressing the **MENU** key, then **Setup**.

A list of setup parameters will be displayed with currently configured setting.

While in the setup menu, it is possible to modify the instrument's operation parameters. The **ARROW** keys permit the user to scroll the setup parameters.

Press **HELP** to view the contextual help.

Press **ESC** to return to the main screen.

### Concentration Unit

mg/L or meq/L

Press the corresponding virtual option key to change the option.

Meter setup	
Conc. unit	mg/L
Meas. Range	LR
Alkalinity Type	Total
Calib. Timeout	Disable
	meq/L

### Measurement Range

LR or HR

Use the table below to determine the appropriate range. Press the corresponding virtual option key to change the option.

Meter setup	
Conc. unit	mg/L
Meas. Range	LR
Alkalinity Type	Total
Calib. Timeout	Disable
	HR

*Note: Different titrant solutions are required for each range.*

### Alkalinity Type

Strong or Total

Use the table below to determine the appropriate range.

Press the corresponding virtual option key to change the option.

Meter setup	
Conc. unit	mg/L
Meas. Range	LR
Alkalinity Type	Total
Calib. Timeout	Disable
	Strong

From your knowledge of expected concentrations, use the table below to determine which settings and solutions are appropriate:

Measurement Range		Low		High	
Range	mg/L	30.0 - 400.0		300 - 4000	
	meq/L	0.6 - 8.0		6.0 - 80.0	
Acidity Type	Total	Strong	Total	Strong	
pH Endpoint	4.5 pH	8.3 pH	4.5 pH	8.3 pH	
Minimum sample pH	> 4.5 pH	> 8.3 pH	> 4.5 pH	> 8.3 pH	

### Calibration Timeout

Disabled or 1 to 7 days

Set the number of days before the pH calibration expired warning message is displayed.

Press **Modify** to access the calibration timeout screen.

Use the **ARROW** keys to select the value.

Press **Select** to confirm or **ESC** to return to the setup menu without saving the changes.

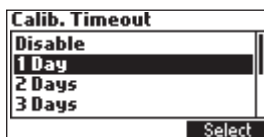
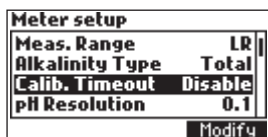

### pH Resolution

0.1 or 0.01

Press the displayed virtual option key to change the resolution.

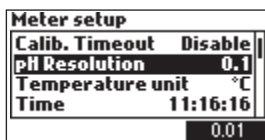

### Temperature Unit

°C, °F or K

Press the virtual option key to change the option.

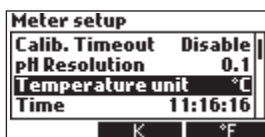

## Time

Press the **Modify** key to change the time format.

Press **Format** to switch between 12 hour (am/pm) and 24 hour mode.

Press **→** to highlight the value to be modified. Use the **ARROW** keys to change the value. Press **Accept** to confirm the new value or **ESC** to return to the setup.

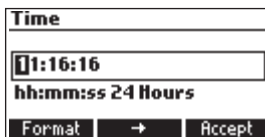
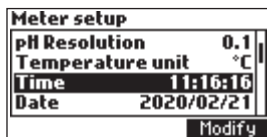

## Date

Press the **Modify** key to change the date format.

Press **Format** to cycle between the available date formats.

Press **→** to highlight the value to be modified. Use the **ARROW** keys to change the value. Press **Accept** to confirm the new value or **ESC** to return to the setup.

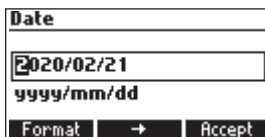
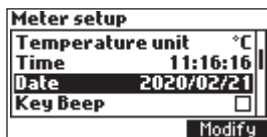

## Key Beep

Select **Enable** to activate or **Disable** to deactivate the Key Beep function.

If enabled, a short beep will be heard every time a key is pressed.

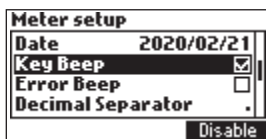

## Error Beep

Select **Enable** to activate or **Disable** to deactivate the Error Beep function.

If enabled, a beep will be heard when an error condition occurs.

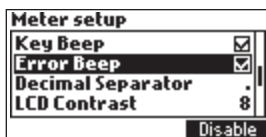



## Decimal Separator

Select the symbol used for a decimal separator.

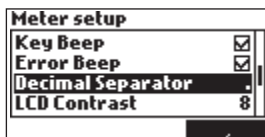

## LCD Contrast

Press **Modify** to change the display's contrast.

The default value is 8.

Use the **ARROW** keys or **← / →** to increase/decrease the value.

Press **Accept** to confirm the value or **ESC** to return to the setup menu.

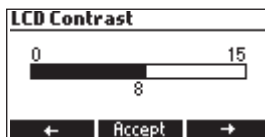
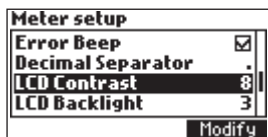

## LCD Backlight

Press **Modify** to change the backlight level.

The default value is 3.

Use the **ARROW** keys or **← / →** to increase/decrease the backlight level.

Press **Accept** to confirm or **ESC** to return to the setup menu.

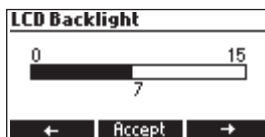
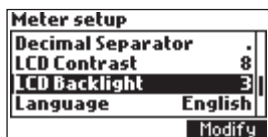

## Language

The only available language is English.

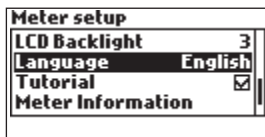

## Tutorial

Enable or Disable the Tutorial. This helpful tool offers additional information during calibration and titration.

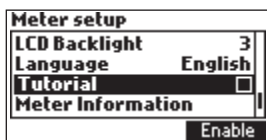

## Meter Information

Press **Select** to view the firmware version, language version, mV factory calibration date and time, temperature factory calibration date and time and method version.

Press **ESC** to return to the setup menu.

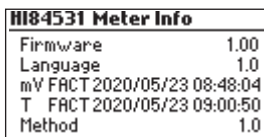
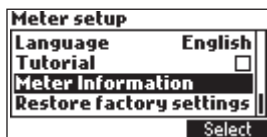

## Restore Factory Settings

Press **Select** to restore the factory settings.

Press **Yes** to confirm the restore process or **No** to return without restoring.

Press **ESC** to return to the setup menu.

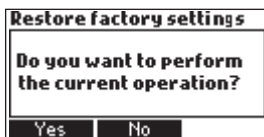
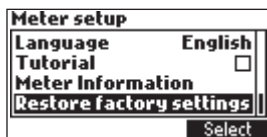

## 8. GUIDE TO DISPLAY CODES



This screen appears when the instrument is turned on during the initialization process.

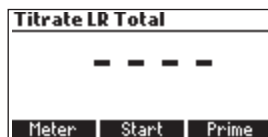

Titration screen display.

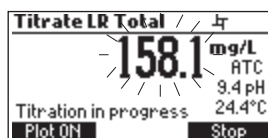

Titration screen when a titration is in progress.

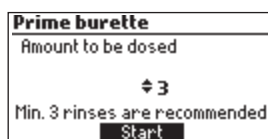

Prime burette screen.



Prime burette screen when the dosing system is running.

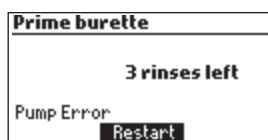

This error message appears when the pump is not working properly. Check the tubing, valve and syringe. Press **Restart** to try again.

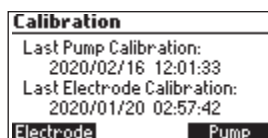

This screen appears when the titrator is in calibration mode. Press **Pump** to calibrate Pump. Press **Electrode** to calibrate pH Electrode.

## 8.1. PUMP CALIBRATION MESSAGES

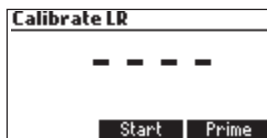

Pump calibration is initiated by pressing the **Start** key.

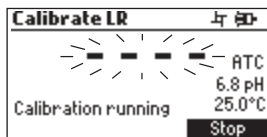

This screen appears while pump calibration is in progress. Press **ESC** or **Stop** key, to return to the Pump Calibration screen.

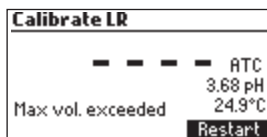

This error message appears during pump calibration when the endpoint can not be reached and the maximum amount of titrant is exceeded. Check standard, electrode and/or dosing system and try again.



The calibration was outside the acceptable limits. Prepare a new standard and try again.

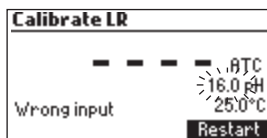

This error message appears when the pH reading exceeds the acceptable input limits ( $-2.00 < \text{pH} > 16.00$ ).

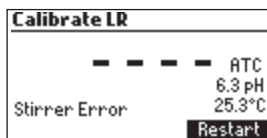

This screen appears when the stirrer is not working properly. Check the stir bar and beaker content. Press **Restart** to try again.

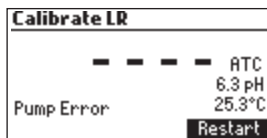

This error message appears when the pump is not working properly. Check the tubing, valve and syringe. Press **Restart** to try again.

## 8.2. pH CALIBRATION MESSAGES

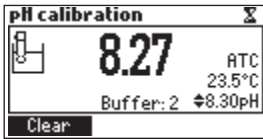

pH calibration mode.

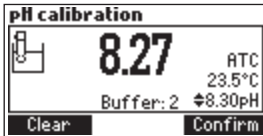

When the reading has stabilized press **Confirm** to accept the calibration or **Clear** to restore the default calibration.

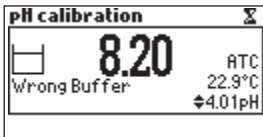

The “Wrong Buffer” message is displayed when the pH value is outside of the acceptable range. Clean the electrode by following the Cleaning Procedure and/or check the buffer concentration before continuing the pH calibration. Press the ESC key to exit pH calibration mode.

## 8.3. TITRATION MESSAGES

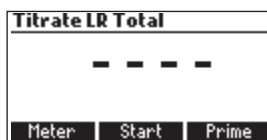

This screen is displayed when the instrument is in titration mode. Press **Start** to begin a titration, **Meter** to enter pH meter mode or **Prime** to enter into the prime function.

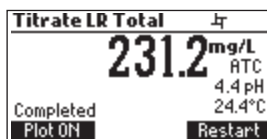

The titration result, expressed in mg/L or meq/L as  $\text{CaCO}_3$ , is displayed automatically at the end of the titration. Press **Restart** to start another titration or **ESC** to return to the main screen.

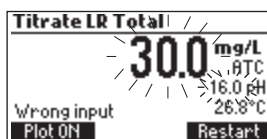

This error message appears when the input reading (pH or temperature) exceeds the specified limits. The pH or temperature value and the concentration will blink indicating an error.



This screen appears when the sample concentration is out of range.

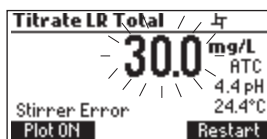

This screen appears when the stirrer is not working properly. Check the stir bar and beaker content. Press **Restart** to try again.

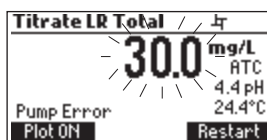

This error message appears when the pump is not working properly. Check the tubing, valve and syringe. Press **Restart** to try again.

## 9. ELECTRODE PREPARATION

Remove the electrode protective cap.

Do not be alarmed if any salt deposits are present. This is normal with electrodes and they will disappear when rinsed with distilled/deionized water.

During transport tiny bubbles of air may have formed inside the glass bulb. The electrode cannot function properly under these conditions. These bubbles can be removed by “shaking down” the electrode as you would do with a glass thermometer.

If the bulb is dry, soak the electrode in [HI70300](#) Storage solution for at least one hour.

## 10. ELECTRODE CALIBRATION PROCEDURE

It is recommended to calibrate the instrument frequently, especially if high accuracy is required.

The pH electrode should be recalibrated:

- whenever the pH electrode is replaced
- at least once a week, but daily is advised
- after testing aggressive chemicals and after electrode is cleaned
- when high accuracy is required
- if the pH calibration expired warning is displayed during measurement

Every time the instrument is calibrated use fresh buffers and clean the electrode (see ELECTRODE CONDITIONING & MAINTENANCE section).

### Procedure

A one, two or three-point calibration can be performed, using the four predefined buffers 4.01, 7.01, 8.30 and 10.01 pH. For a one point calibration any of the three buffers may be used, 8.30 pH is recommended.

*Note: The HI84531 will not accept other pH buffers for calibration.*

- Pour small quantities of selected buffer solutions into clean beakers. For accurate calibration use two beakers for each buffer solution, the first one for rinsing the electrode and the second one for calibration.
- Put a magnetic stir bar in the beaker that will be used for calibration.
- Remove the protective cap and rinse the electrode with some of the buffer solution to be used for the first calibration point.
- Put the first beaker with calibration buffer in the beaker holder.
- Place the electrode holder on the top of the beaker and secure it by turning clockwise and press **STIR**.
- Immerse the pH and the temperature probe approximately 2 cm (0.8") into the buffer paying attention not to touch the stir bar.

To enter Electrode Calibration follow the next steps:

- Press **CAL** key then **Electrode**.
- The electrode calibration screen will be displayed.
- Press **Clear** to delete the previous calibration.



## One-Point Calibration

- The 8.30 buffer will be selected by default. If necessary, press the **ARROW** keys in order to select a different buffer value.
- The  $\Sigma$  (unstable measurement) symbol will be shown on the display until the reading becomes stable.

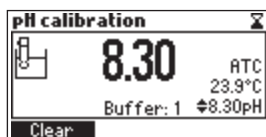

- When the reading is stable and close to the selected buffer, the  $\Sigma$  (unstable measurement) symbol will disappear and the **Confirm** key will become active.

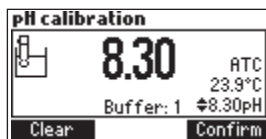

- Press **Confirm** to confirm the calibration or **ESC** to exit calibration.
- After the calibration point has been confirmed, press **ESC** to exit without performing the second calibration point.

## Two-Point Calibration

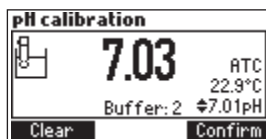

- The calibrated value will be shown on the display and the second expected buffer value will be displayed.



- Remove the electrode holder with electrodes from the top of the beaker.
- Place the second beaker with calibration buffer in the beaker holder. Rinse the electrodes in a beaker containing the second buffer rinsing solution.
- Place the electrode holder (with electrodes) on the top of the beaker and secure it by turning clockwise and press **STIR**.
- If necessary, press the **ARROW** keys in order to select a different buffer value.
- The  $\Sigma$  (unstable measurement) symbol will be shown on the display until the reading becomes stable.
- When the reading is stable and close to the selected buffer, the  $\Sigma$  (unstable measurement) symbol will disappear and the **Confirm** key will become active.

- Press **Confirm** to confirm the calibration.
- The calibrated value will be shown on the display and the third expected buffer value will be automatically selected.
- After the second calibration point has been confirmed, press **ESC** to exit without performing the third calibration point.

### Three-Point Calibration

- Remove the electrode holder with electrodes from the top of the beaker.
- Place the third beaker with calibration buffer in the beaker holder. Rinse the electrodes in a beaker containing the third buffer rinsing solution.
- Place the electrode holder (with electrodes) on the top of the beaker and secure it by turning clockwise and press **STIR**.
- The  (unstable measurement) symbol will be shown on the display until the reading becomes stable.
- When the reading is stable and close to the selected buffer, the  (unstable measurement) symbol will disappear and the **Confirm** key will become active.
- Press **Confirm** to confirm the calibration. The instrument stores the calibration value and returns to calibration menu, where the date and time for the pH calibration will be updated.

*Note: A buffer confirmed during the calibration process is removed from the list of available buffers.*

### Error Messages During Calibration

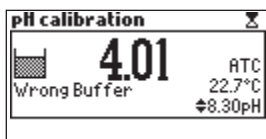

- If the value measured by the instrument is not close to the selected buffer a “Wrong Buffer” error message will be shown on the display.

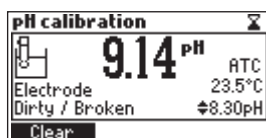
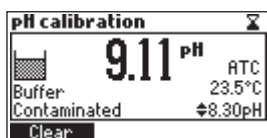

Check if the correct buffer has been used or regenerate the pH electrodes by following the Cleaning Procedure (see ELECTRODE CONDITIONING & MAINTENANCE section). If necessary change the buffer or the electrode.

- If the measured offset isn't within the preset limits ( $\pm 45$  mV), the meter will display the message “Buffer Contaminated” alternatively with “Electrode Dirty/Broken”.



- If the computed slope isn't within the preset limits, the meter will display the message "Wrong Slope". If the slope is too high, the symbol  will be displayed. If the slope is too low, the symbol  will be displayed.

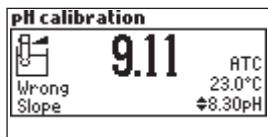

- If the "Wrong Old Slope" error message is displayed, an inconsistency exists between the current and the previous (old) calibration. Clear the previous calibration by pressing Clear and proceed with calibration from the current calibration point. The instrument will keep all the confirmed values during the current calibration.



- If the temperature reading is out of the defined temperature range of the buffer (0 to 45 °C), the "Wrong Buffer Temperature" error message will be displayed, and the temperature symbol will blink on the display. Calibration cannot be confirmed in this situation.

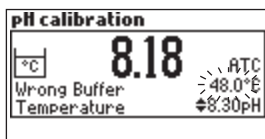

**Notes:** To clear a previous calibration and to return to the default value, press Clear at any time after entering calibration mode. If Clear is invoked during the first calibration point the instrument returns to the measurement mode.

The Clear key is displayed only if a previous calibration exists.

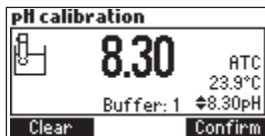

## 11. pH BUFFER TEMPERATURE DEPENDENCE

Temperature has an effect on pH. The calibration buffer solutions are affected by temperature changes to a lesser degree than normal solutions. During calibration, the instrument will automatically calibrate to the pH value corresponding to the measured or set temperature.

TEMP		pH BUFFERS			
°C	°F	4.01	7.01	8.30	10.01
0	32	4.01	7.13	8.48	10.32
5	41	4.00	7.10	8.44	10.24
10	50	4.00	7.07	8.41	10.18
15	59	4.00	7.04	8.37	10.12
20	68	4.00	7.03	8.33	10.06
25	77	4.01	7.01	8.30	10.01
30	86	4.02	7.00	8.27	9.96
35	95	4.03	6.99	8.24	9.92
40	104	4.04	6.98	8.21	9.88
45	113	4.05	6.98	8.18	9.85

During calibration the instrument will display the pH buffer value at 25 °C.

## 12. DOSING PUMP INSTALLATION

To install the dosing pump follow the procedure below:

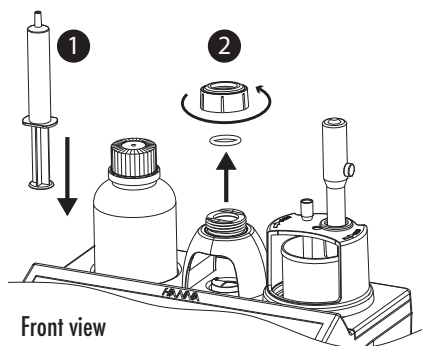

1. Extend the plunger on the 5 mL syringe to its maximum volume.
2. Unscrew the syringe-fixing nut and remove the o-ring.

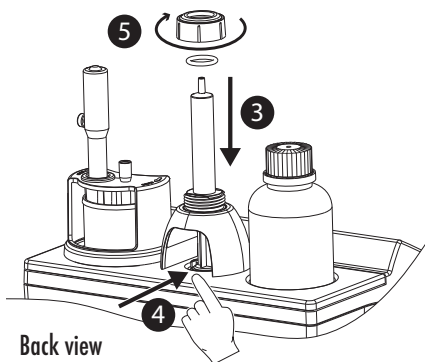

3. Place the syringe in the dedicated spot on the top of the meter.
4. Arrange the bottom of the syringe into the pump holder. Once the syringe is in place lower the barrel until it sits flush on the holder.
5. Put the o-ring and syringe-fixing nut over the syringe. Turn clockwise to secure it in place.

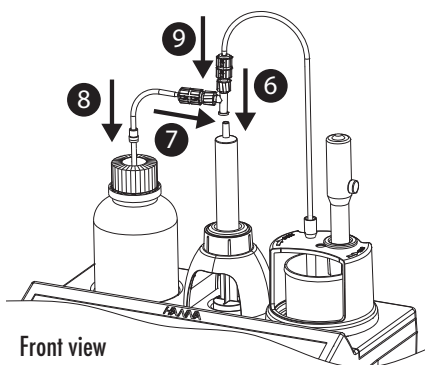

6. Place the valve on top of the syringe. Ensure it fits securely.
7. Insert the aspiration tube into the valve left side.
8. Replace the cap of the titrant bottle with the attached cap.
9. Insert the dispensing tube into the valve top.

### 13. DOSING PUMP PRIME PROCEDURE

Prime cycle should be performed:

- if there is no titrant in the tip
- whenever the dosing system tubes are replaced
- whenever a new bottle of titrant is used
- before starting a pump calibration
- before starting a series of titrations

The prime cycle is used to fill the syringe before starting a set of titrations.

Two rinses cycles of syringe are shown in the figure below. The dispensing tube is connected to the top of the valve and the aspiration tube on the left side.

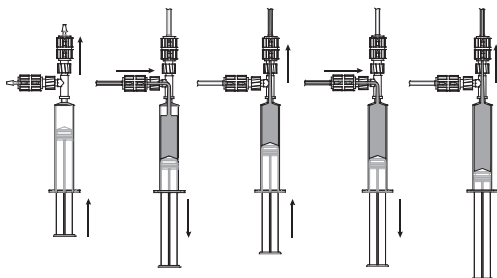

*Note: The aspiration tube must be inserted in the titrant bottle. The dosing tip must be placed over a rinse beaker.*

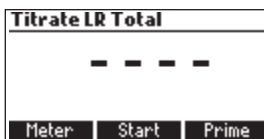

- To prime the burette, select **Prime** option from Titration mode.
- Adjust the rinses number by pressing the **ARROW** keys and press **Start**.

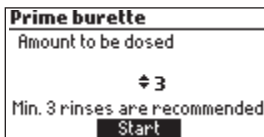

- The number of syringe rinses can be set between 1 and 5 (at least three rinses are recommended to ensure that the air bubbles are completely removed).

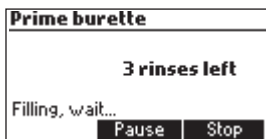

- To pause the prime process press the **Pause**, to continue press the **Continue**. To stop the prime process press **Stop**.

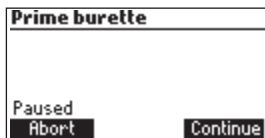

**Note:** This error message appears when the pump is not working properly. Check the tubing, valve and syringe. Press *Restart* to try again.



## 14. PUMP CALIBRATION PROCEDURE

The calibration of the pump must be performed every time the syringe, pump tube, the titrant bottle or the pH electrode is changed. A pump calibration is recommended before each set of titrations, after the titrator is left idle for several hours or once daily.

- Press **MENU**, select **Setup** and select the corresponding range according to the table below:

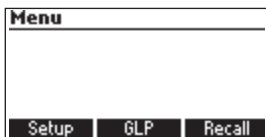

UNIT	Low Range	High Range
mg/L	30.0 to 400.0	300 to 4000
meq/L	0.6 to 8.0	6.0 to 80.0

- Verify the electrode has been calibrated in 8.30 pH buffer.
- Ensure the pump is primed with the correct titrant for the selected range (**HI84531-50** Low Range Titrant and **HI84531-51** High Range Titrant).

**Note:** Before performing a calibration in high range dispense roughly 1 mL of titrant in a waste beaker. This will remove any air bubbles in the tubing. Press Prime then Stop once the volume has been delivered.

**Sample preparation:** Use a clean pipette to add precisely measured amount of **HI84531-55** Calibration Standard to a clean beaker as indicated below:

Low Range (LR Strong, LR Total) - 2 ml 30.0 - 400.0 mg/L as CaCO<sub>3</sub>

High Range (HR Strong, HR Total) - 20 ml 300 - 4000 mg/L as CaCO<sub>3</sub>

**Note:** Failure to use a clean pipette will result in erroneous readings.

- Fill the beaker up to the 50 mL mark with the distilled or deionized water.



- Press **CAL** key. The instrument displays the date and time of the last electrode calibration, and the last pump calibration.
- Press **Pump** key.

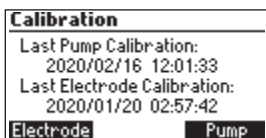

**Note:** Do not place the tip into the calibration beaker, place the tip over a waste beaker. A small amount of titrant is dispensed when the pump resets.



- Press **Start**, wait for the syringe refill.



- Place the stir bar in the calibration solution beaker and put the beaker in the mini titrator top.
- Place the probe holder on the top of the beaker and secure it by turning clockwise.

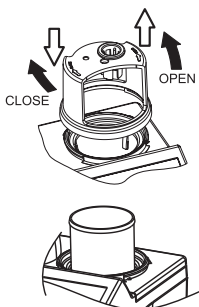

- Rinse the pH electrode with deionized water and immerse into the calibration solution until the reference junction is completely submerged. Be sure that the tip of the electrode is not hitting the stir bar. If necessary, additional distilled or deionized water can be added.
- Verify if the titrant corresponds to selected titration range.
- Insert the dosing tip into the titrant tube sleeve. It is critical that the tip be immersed approximately 0.25 cm (0.1") into the solution being titrated.

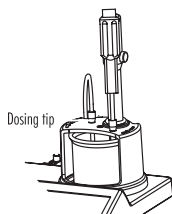

- Press **Continue** to begin the calibration and **Stop** to abort it.

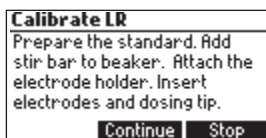

- At the end of the calibration, "Calibration Completed" appears on display. To repeat the calibration press **Restart** or **ESC** to return to the main screen.

### Notes:

If temperature probe is not connected, Manual Temperature Compensation is used and MTC appears on the right side of the screen. If Automatic Temperature Compensation is in use the ATC appears on the right side of the screen.

If an erroneous situation is encountered during the calibration, an error message is displayed and the calibration can be restarted by pressing **Restart**. Prepare a new standard, rinse electrode, temperature probe and dosing tip and try again.



If the calibration doesn't complete and the max titrant volume of titrant is reached an error message will be displayed. The calibration can be restarted by pressing **Restart**. Prepare a new standard, rinse electrode, temperature probe and dosing tip and try again.

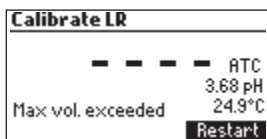

This error message appears when the pH reading exceeds the acceptable input limits ( $-2.00 < \text{pH} < 16.00$ ).

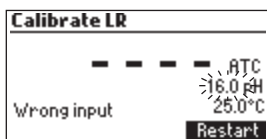

This screen appears when the stirrer is not working properly. Check the stir bar and beaker content. Press **Restart** to try again.

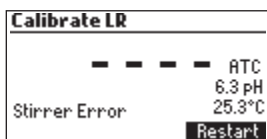

*This error message appears when the pump is not working properly. Check the tubing, valve and syringe. Press Restart to try again.*

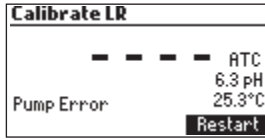

## 15. TITRATION PROCEDURE

For best accuracy, before taking any measurement, ensure that the pump is calibrated on the selected range following the description in the PUMP CALIBRATION PROCEDURE section.

**Note:** Verify that the instrument has been calibrated (pH and pump) before performing any titrations. An electrode calibration in 8.30 pH buffer is recommended.

- Refer to instructions described in SETUP MENU section to set up instrument for your measurement.
- Select the corresponding measurement range.

**Note:** Before performing a titration in high range dispense roughly 1 mL of titrant in a waste beaker. This will remove any air bubbles in the tubing. Press Prime then Stop once the volume has been delivered.

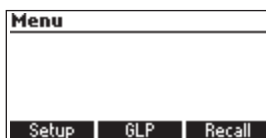

Low Range (50 mL sample)	High Range (50 mL sample)
30.0 to 400.0 mg/L as CaCO <sub>3</sub>	300 to 4000 mg/L as CaCO <sub>3</sub>
0.6 to 8.0 meq/L as CaCO <sub>3</sub>	6.0 to 80.0 meq/L as CaCO <sub>3</sub>

**Sample preparation:** Use a clean pipette to add precisely measured amount of sample to a clean beaker as indicated below:

Low Range (50 ml) - 30.0 - 400.0 mg/L as CaCO<sub>3</sub>

High Range (50 ml) - 300 - 4000 mg/L as CaCO<sub>3</sub>

**Note:** Failure to use a clean pipette will result in erroneous readings.

- Put the 50 mL sample in the 100 mL beaker.
- Press **Titration**.



**Note:** Do not place the tip into the sample beaker. Place the tip over a waste beaker. A small amount of titrant is dispensed when the pump resets.

- Press **Start** to begin a titration.

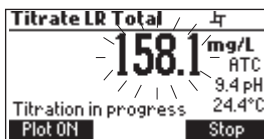
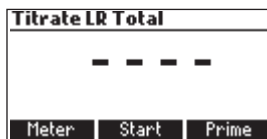

- Place the stir bar in the beaker and put the beaker in the mini titrator top.

- Place the probe holder on the top of the beaker and secure it by turning clockwise.

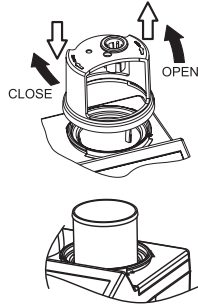

- Rinse the pH electrode with deionized water and immerse into the sample until the reference junction is completely submerged. Be sure that the tip of the electrode is not hitting the stir bar.
- Insert the dosing tip into the titrant tube sleeve. It is critical that the tip be immersed approximately 0.25 cm (0.1") into the solution being titrated.

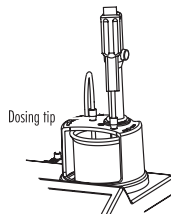

- Press **Continue** to begin the titration and **Stop** to abort it.

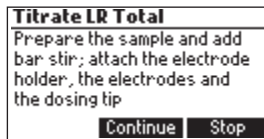

- The instrument will continuously update the concentration on the display. The value will be displayed blinking. When the reading is under range, "----" symbol appears blinking.

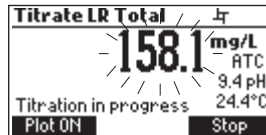
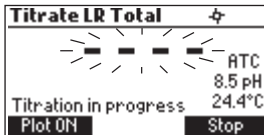

- The titration curve can be visualized during a titration by pressing **Plot ON**. Press **Plot OFF** or **ESC** to exit this mode.

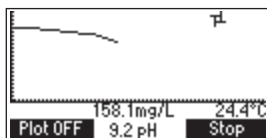

- At the end of the titration, the total or strong alkalinity of water sample in the selected unit of measurement (mg/L or meq/L) is displayed. The titration curve can be viewed by pressing **Plot ON**. Press **Plot OFF** or **ESC** to exit this mode.

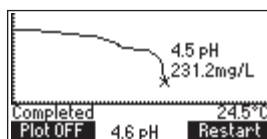
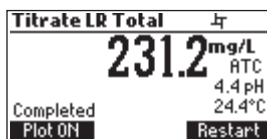

- Press **LOG** to record the concentration value into the instrument's memory. A message will be displayed for a few seconds indicating the amount of the free log space. Up to 200 log samples can be recorded in the instrument's memory.

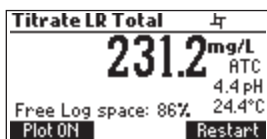

- Press **Restart** to begin a new titration or **ESC** to return to the titration menu.
- If the concentration exceeds the range limits, the exceeded range limit will be displayed blinking. Another titration can be started by pressing **Restart**.

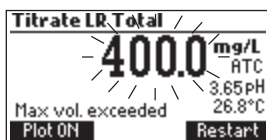

- "Wrong input" error message appears when the input reading (pH, temperature) exceeds the specified limits. The pH or temperature value and concentration will blink indicating an error.

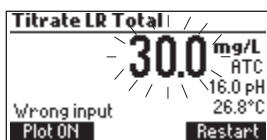

- This screen appears when the stirrer is not working properly. Check the stir bar and beaker content. Press **Restart** to try again.

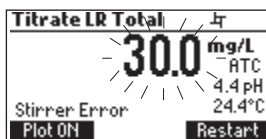

- This error message appears when the pump is not working properly. Check the tubing, valve and syringe. Press **Restart** to try again.

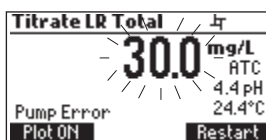

### 15.1. TIPS FOR AN ACCURATE MEASUREMENT

The instructions listed below should be followed carefully to ensure measurements are conducted with the highest possible accuracy and precision.

- It is critical that the tip be immersed in the solution being titrated (approximately 0.25 cm).
- Use a clean, volumetric pipette to measure and transfer the necessary volume of sample into the titration beaker.
- Calibrate the pump prior to each series of titrations.
- Calibrate the pump if the meter is left idle for several hours.
- Analyze the sample immediately after the sample is obtained.
- For better performance, soak the electrode in [HI70300](#) storage solution for at least one hour, before use.

### 15.2. VIEW/DELETE TITRATOR RECORDED DATA

Press **MENU** then **Recall** to access the Titrator logs.

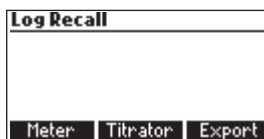
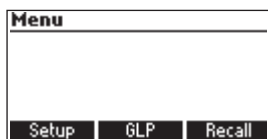

When an external USB storage device is connected, the **Export** key is displayed. It saves the meter and titrator logs in two text format files on the storage device.

Press **Meter** or **Titrator** to view the respective logs.

The instrument will display a list of all the records stored in the log.

Use the **ARROW** keys to scroll the stored records list.

If the saved concentration was out of range, the “<” or “>” symbols are displayed in front of the reading.

	mg/L	Date
1	< 30.0	2020-06-01
2	< 300	2020-06-01
3	182.0	2020-06-01
4	>400	2020-06-01

Delete Del.All Info

Press **Delete** to delete the selected record from the memory.

Press **Del.All** to delete all the records.

Press **Info** to see detailed information about the highlighted record.

The selected record data and the titration curve data file name are displayed.

Record number: 3	
2020-06-01	11:02:47 AM
182.0mg/L	24.8°C
0617416.txt file	
Plot	Export

When an USB storage device is connected, the Export key is displayed. It saves the titration curve data as a text file on the storage device using the displayed file name.

Use the **ARROW** keys when  $\blacktriangle$  is displayed to scroll between the log records.

Press **ESC** to return to the previous screen.

Record number: 3	
2020-06-01	11:02:47 AM
182.0mg/L	24.8°C
0617416.txt file	
Plot	$\blacktriangle$

Press **Plot** to visualize the titration curve or **ESC** to return to the previous screen. On the titration curve, the endpoint volume and pH are displayed. The titration data (Total Titrant Volume on the x-axis and pH on the y-axis) can be scanned through with the dotted line by using the **ARROW** keys.

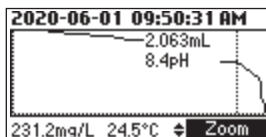

To zoom on the titration curve press **Zoom**.



If **Delete** or **Del.All** is pressed the instrument will ask for confirmation.

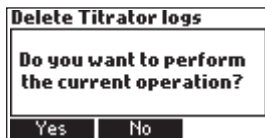
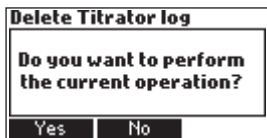

Press **Yes** to delete all the records or **No** to return to the previous screen.

Deleting a single record will renumber the list of records.

If the titrator log is empty, the message "No Records Available!" will be displayed.

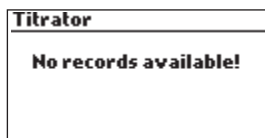

### 15.3. TITRATOR GLP INFORMATION

Press **MENU** then **GLP**.

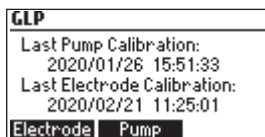
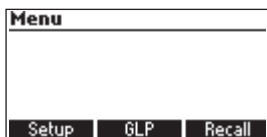

From this screen it is possible to select **Electrode** or the **Pump** GLP.

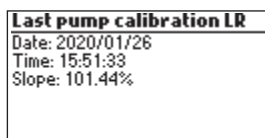

Press **Pump** to view the pump's last calibration time, date and slope.

If a calibration hasn't been performed, the message "Not Calibrated" will be displayed.

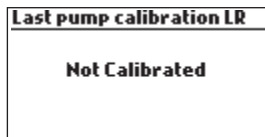

## 16. pH MEASUREMENT

The HI84531 can be used as a pH meter for direct measurements.

Verify that the instrument has been calibrated before taking pH measurements. Set the instrument to pH meter. From titrator mode press **Meter** until pH units are displayed.

If an electrode calibration hasn't been performed, or the number of days exceeds the calibration time out value set, the message "CAL DUE" will blink on the left side of the display (see Calibration Timeout option in SETUP MENU section for details).

If "CAL DUE" is displayed, perform an electrode calibration.

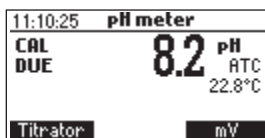

Press **MENU** to access the instrument's menu.

Press **HELP** to view the contextual help, every time you need additional information.

Press **STIR** to start/stop the stirrer.

Press **Titrator** to enter titration mode.

Press **CAL** to access the calibration menu.

Press **LOG** to save the current reading. A message indicating the free log space will be displayed for a few seconds.

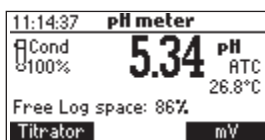

In order to take pH measurements, follow the next steps:

- Submerge the tip of pH electrode 2 cm (0.8") and the temperature probe into the sample to be tested and stir gently. Allow time for the electrode to stabilize. When the reading becomes stable, the  (unstable measurement) symbol will disappear.

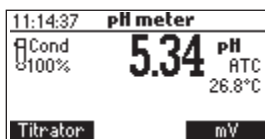

- If the pH reading is less than -2.00 pH or greater than 16.00 pH, the closest full-scale value will be displayed blinking.

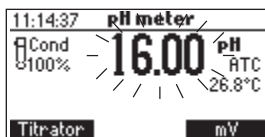

If measurements are taken successively in different samples, it is recommended to rinse the electrodes thoroughly with deionized or distilled water and then with some of the next sample to prevent cross-contamination.

The pH measurement is affected by temperature. In order to have accurate pH measurements, the temperature effect must be compensated for. To use the Automatic Temperature Compensation (ATC) feature, connect and submerge the [HI7662-T](#) temperature probe into the sample as close as possible to the electrode and wait for a few seconds. The “ATC” message will be shown on the display. Automatic Temperature Compensation will provide pH corrected values for the measured temperature. If Manual Temperature Compensation (MTC) is desired, the temperature probe must be disconnected from the instrument.

The default temperature of 25 °C (77 °F) or the last temperature reading will be displayed preceded by the symbol  $\blacklozenge$  and the “MTC” message.

The temperature can be adjusted with the **ARROW** keys (from -20.0 to 120.0 °C).

### 16.1. VIEW/DELETE RECORDED pH DATA

Press **MENU** key while in pH meter screen then **Recall** to access the meter logs.

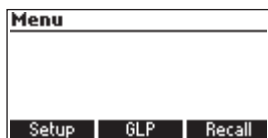

When an external USB storage device is connected, the **Export** key is displayed. It saves the meter and titrator logs in two text format files on the storage device.

Press **Meter** or **Titrator** to view the respective logs.

A list of records is stored in the pH log.

If the saved mV/pH measurements are out of range, the “<” or “>” symbols are displayed in front of the reading.

	mV/pH	Date
1	5.24pH	2020/05/22
2	> 16.00pH	2020/05/22
3	< -2000.0mV	2020/05/22
4	-100.0mV	2020/05/22

At the bottom of the screen are three buttons: Delete, Del.All, and Info.

Use the **ARROW** keys to scroll the list of records.

Press **Delete** to delete the selected record.

Press **Del.All** to delete all the records.

Press **Info** to see detailed information about the highlighted record.

Use **ARROW** keys when  is displayed to scroll between the records.

Record number: 1	
2020/05/22	16:01:48
5.24 pH	25.1°C
Offset: 0.02mV	
Slope: 100.1%	
	

Press **ESC** to return to the previous screen.

If **Delete** or **Del.All** is pressed the instrument will ask for confirmation.

Delete Meter log	
<b>Do you want to perform the current operation?</b>	
Yes	No

Delete Meter logs	
<b>Do you want to perform the current operation?</b>	
Yes	No

Press **Yes** to delete the record or **No** to return to the previous screen without deleting.

Deleting a single record will renumber the list of records.

If the pH log is empty, the message “No records available!” will be displayed.

Measure
<b>No records available!</b>

## 16.2. pH METER GLP INFORMATION

The pH meter GLP screens displays the pH calibration data.

To view this information, press **MENU** key while in pH meter mode then **GLP**.

Press **Electrode** to view information regarding electrode calibration.

Last Electrode Calibration	
Date: 2020/05/22	10.01
Time: 16:15:03	8.30
Cal Expire: Disabled	4.01
Offset: -0.9mV	
Slope: 100.0%	
Electrode Condition: 100%	

The following items are included in electrode GLP: the time and date of the last calibration, offset, slope, electrode condition, calibration timeout and the calibration buffers. The buffers displayed in video inverse mode are from the previous calibration.

If a calibration hasn't been performed, the message “Not Calibrated” will be displayed.

Last Electrode Calibration
<b>Not Calibrated</b>

## 17. PC INTERFACE & DATA TRANSFER

Data stored on meter with the LOG function during pH/mV measurement and titrations can be transferred from the meter to a USB stick using the Export function from the log recall menu. Two text files are transferred on the USB stick. These files can be used for further analysis on a PC.

The logged data can also be transferred from the instrument to the PC using a USB cable. Connect the USB cable and the following screen will be displayed.

Press **Meter** to generate the text file with Meter log data.

Press **Titrator** to generate the text file with Titrator log data.

Press **Plot** to generate the text files with Titration Plots.



The generated files are now visible and can be used for further analysis.

If the instrument has no logged Meter or Titrator records, the PC connected screen is displayed.



## 18. ELECTRODE CONDITIONING & MAINTENANCE

### Storage Procedure

To assure a quick response time, the glass bulb should be kept moist and not allowed to dry out. Replace the solution in the protective cap with a few drops of [HI70300](#) or [HI80300](#) Storage solution. Follow the Preparation Procedure section before taking measurements.

**Note:** *Never store the pH electrode in distilled or deionized water.*

### Periodic Maintenance

Inspect the electrodes and the cables. The cable used for connection to the instrument must be intact and there must be no broken insulation on the cable or cracks on the electrode stem or bulb. Connectors must be perfectly clean and dry. If any scratches or cracks are present, replace the electrode. Rinse off any salt deposits with distilled/deionized water.

### pH Cleaning Procedure

- Soak in Hanna Instruments [HI7061](#) or [HI8061](#) General cleaning solution for approximately ½ hour.

**Important:** *After performing any of the cleaning procedures, rinse the electrode thoroughly with distilled or deionized water and soak the electrode in [HI70300](#) or [HI80300](#) Storage Solution for at least 1 hour before use. Recalibrate electrode before taking measurements.*

## 19. TROUBLESHOOTING GUIDE

SYMPTOMS	PROBLEM	SOLUTION
Slow response/excessive drift.	Dirty pH electrode.	Soak the electrode tip in <a href="#">HI7061</a> cleaning solution for 30 minutes and follow the cleaning procedure. Refill with fresh fill solution.
Reading fluctuates up and down (noise).	Clogged/dirty junction. Low electrolyte level (refillable pH electrodes only). Cable connection.	Soak the electrode tip in <a href="#">HI7061</a> cleaning solution for 30 minutes. Refill with fresh fill solution. Check cable connection to meter and verify protective cap is off.
While in pH reading mode, -2.00 or 16.00 pH is displayed blinking.	Reading out of range.	Check cable connection to meter and verify protective cap is off. Check the quality of the sample. Clean the electrodes. Refill with fresh fill solution.
The meter does not accept the pH buffer solution for calibration.	Broken pH electrode.	Follow the electrode cleaning procedure. If the error persists replace the electrode or contact the vendor.
The pump calibration can't be performed	Broken pump tubing. Wrong or contaminated pump calibration solution. Broken pH electrode.	Verify tubing, valve, syringe are intact and solution passes when pump is primed and no air bubbles are present. Check the pump calibration solution. Verify electrode is calibrated in fresh pH buffers. Prepare another standard, prime the pump and restart the calibration.
The temperature probe is connected, but the meter displays "MTC".	Broken temperature probe.	Replace temperature probe.

SYMPTOMS	PROBLEM	SOLUTION
After a titration the following is displayed blinking: Low Range: 400.0 mg/L or 8.0 meq/L High Range: 4000 mg/L or 80 meq/L.	Broken electrode. Instrument not calibrated. Wrong range selected. Concentration out of range.	Check/clean the electrode. Recalibrate the instrument (pH and pump). Use care during sample preparation. Change selected range.
At startup the meter displays the Hanna Instruments logo permanently.	One of the keys is stuck.	Check the keyboard or contact the vendor.
"Error xx" message is displayed.	Internal error.	Power off the meter and then power it on again. If the error persists, contact the vendor.
"Stirrer error" message is displayed at the end of pump calibration or titration.	Stirrer not functioning properly.	If the error persists, contact the vendor.
Non-spinning stirrer icon blinking in pH calibration and meter mode.	Stirrer not functioning properly.	If the error persists, contact the vendor.
"Pump error" message is displayed.	Check the tubing, valve and syringe.	If the error persists, contact the vendor.
At startup the meter displays "Methods corrupted".	The method file was corrupted.	Contact the vendor.



## 20. ACCESSORIES

REAGENTS	
HI84531-50	Low Range titrant, 120 mL
HI84531-51	High Range titrant, 120 mL
HI84531-55	Calibration standard, 230 mL
pH CALIBRATION SOLUTIONS	
HI7004M	pH 4.01 buffer solution, 230 mL
HI7007M	pH 7.01 buffer solution, 230 mL
HI70083M	pH 8.30 buffer solution, 230 mL
HI7010M	pH 10.01 buffer solution, 230 mL
ELECTRODES	
HI1131B	pH Electrode
HI7662-T	Temperature probe
ELECTRODE FILL SOLUTION	
HI7082	Electrode fill solution, 30 mL (4 pcs.)
ELECTRODE STORAGE SOLUTION	
HI70300M	Storage solution, 230 mL
HI70300L	Storage solution, 500 mL
HI80300M	Storage solution, 230 mL
HI80300L	Storage solution, 500 mL
ELECTRODE CLEANING SOLUTION	
HI7061M	Electrode cleaning solution, 230 mL
HI7061L	Electrode cleaning solution, 500 mL
HI8061M	Electrode cleaning solution, 230 mL
HI8061L	Electrode cleaning solution, 500 mL
OTHER ACCESSORIES	
HI70501	Tube set with cap for titrant bottle, tip and valve
HI7100051/8	115 Vac to 12 Vdc, 800 mA
HI7100061/8	230 Vac to 12 Vdc, 800 mA
HI731319	Stir bar (10 pcs., 25x7 mm)
HI731342	Automatic pipette 2000 $\mu$ L
HI731352	Tips for 2000 $\mu$ L automatic pipette (4 pcs.)
HI740036P	100 mL plastic beaker (10 pcs.)
HI740037P	20 mL plastic beaker (10 pcs.)
HI740236	5 mL syringe for mini titrator (6 pcs.)
HI920013	PC connection cable

## CERTIFICATION

All Hanna Instruments conform to the **CE European Directives**.



**Disposal of Electrical & Electronic Equipment.** The product should not be treated as household waste. Instead hand it over to the appropriate collection point for the recycling of electrical and electronic equipment which will conserve natural resources.

Ensuring proper product disposal prevents potential negative consequences for the environment and human health. For more information, contact your city, your local household waste disposal service, or the place of purchase.



## RECOMMENDATIONS FOR USERS

Before using this product, make sure it is entirely suitable for your specific application and for the environment in which it is used. Any variation introduced by the user to the supplied equipment may degrade the instrument's performance. For your and the instrument's safety do not use or store the instrument in hazardous environments.

## WARRANTY

**HI84531** is warranted for two years against defects in workmanship and materials when used for its intended purpose and maintained according to instructions. Electrodes and probes are warranted for a period of six months. This warranty is limited to repair or replacement free of charge. Damage due to accidents, misuse, tampering or lack of prescribed maintenance is not covered.

If service is required, contact your local Hanna Instruments Office. If under warranty, report the model number, date of purchase, serial number (see engraved on the back of the instrument) and the nature of the problem. If the repair is not covered by the warranty, you will be notified of the charges incurred. If the instrument is to be returned to Hanna Instruments, first obtain a Returned Goods Authorization number from the Technical Service department and then send it with shipping costs prepaid. When shipping any instrument, make sure it is properly packed for complete protection.

Hanna Instruments reserves the right to modify the design, construction or appearance of its products without advance notice.

## World Headquarters

Hanna Instruments Inc.  
Highland Industrial Park  
584 Park East Drive  
Woonsocket, RI 02895 USA  
[www.hannainst.com](http://www.hannainst.com)



MAN84531

Printed in ROMANIA