

HI84533

Formol Number

Mini Titrator & pH Meter

for Fruit Juices and Wines Analysis



INSTRUCTION MANUAL

Dear
Customer,

Thank you for choosing a Hanna Instruments product.

Please read this instruction manual carefully before using this instrument.

This manual will provide you with the necessary information for correct use of this instrument, as well as a precise idea of its versatility.

If you need additional technical information, do not hesitate to e-mail us at tech@hannainst.com or view our worldwide contact list at www.hannainst.com.

All rights are reserved. Reproduction in whole or in part is prohibited without the written consent of the copyright owner, Hanna Instruments Inc., Woonsocket, Rhode Island, 02895, USA.

TABLE OF CONTENTS

1. Preliminary Examination	4
2. General Description & Intended Use	5
3. Specifications	7
4. Principle of Operation	9
5. Functional Description.....	10
6. Titrator Startup.....	13
7. Setup Menu	14
8. Guide to Display Codes.....	19
8.1. Pump Calibration Messages	20
8.2. pH Calibration Messages	21
8.3. Titration Messages	21
9. Electrode Preparation	23
10. Electrode Calibration Procedure.....	24
11. pH Buffer Temperature Dependence.....	28
12. Dosing Pump Installation	29
13. Dosing Pump Prime Procedure	30
14. Pump Calibration Procedure.....	32
15. Titration Procedure.....	35
15.1. Tips for an Accurate Measurement	39
15.2. View / Delete Titrator Recorded Data.....	40
15.3. Titrator GLP Information.....	41
16. pH Measurement	43
16.1. View / Delete Recorded pH Data.....	44
16.2. pH Meter GLP Information	46
17. PC Interface & Data Transfer	47
18. Electrode Conditioning & Maintenance.....	48
19. Troubleshooting Guide.....	49
20. Accessories.....	51
Certification.....	52
Recommendations for Users.....	52
Warranty	53

1. PRELIMINARY EXAMINATION

Remove the instrument and accessories from the packaging and examine it carefully. For further assistance, please contact your local Hanna Instruments Office or email us at tech@hannainst.com.

Each HI84533 mini titrator is supplied with:

- HI1131B pH electrode
- HI7662-T Temperature probe
- HI84533-70 Reagent kit for formol number in wine and fruit juices
- HI7082 Electrode fill solution (30 mL)
- Cleaning solution for wine deposits, sachet (2 pcs.)
- Cleaning solution for wine stains, sachet (2 pcs.)
- 100 mL beaker (2 pcs.)
- Tube set (aspiration tube with titrant bottle cap and dispensing tube with tip)
- Dosing pump valve
- 5 mL syringe (2 pcs.)
- 2000 μ L automatic pipette
- Plastic tip for automatic pipette (2 pcs.)
- Capillary dropper pipette
- Stir bar
- Power adapter
- Instruction manual

Note: Save all packing material until you are sure that the instrument works correctly. Any damaged or defective item must be returned in its original packing material with the supplied accessories.

2. GENERAL DESCRIPTION & INTENDED USE

The HI84533 is an affordable, easy to use, microprocessor-based automatic titrator that benefits from Hanna Instruments' years of experience as manufacturer of analytical instruments.

The instrument incorporates a simple and reliable dosing pump which ensures high dosing reproducibility. Pump calibrations, performed with the provided Hanna Instruments reagents, assure the accuracy of the instrument.

The instrument comes with a preprogrammed method for Formol measurements in fruit juices and wines.

The HI84533 performs the analysis and all the necessary calculations, with a simple and effective user interface.

By simply pressing the **Start** key in Titrator mode, the instrument will automatically titrate the sample to the endpoint. The current pH and temperature are continuously displayed during titration process. The result is immediately displayed in mg/L, then the instrument is ready for another titration by pressing the **Restart** key.

A dedicated **HELP** key aids in setup, calibration, status and troubleshooting.

Other features:

- pH meter / mV meter
- Stir speed control
- Graphic mode to display the titration data
- Data can be stored using the log feature and then exported to a USB stick or transferred to a PC using the USB connection
- Log on demand for up to 400 samples (200 for mV/pH measurements; 200 for titration results)
- GLP feature, to view calibration data for pH electrode and pump

Significance of Use

The amino-acid content in fruit juices and wines is expressed as nitrogen total assimilable determined by formol method using an acid-base titration.

The formol number (known also as formol index) is a parameter used for evaluation of the quality of fruit juices or wines (eg: 150-200 mg/L of assimilable N is the minimum required to avoid any problem of stuck fermentation due to lack of nitrogen). The concentration of alpha amino nitrogen in grapes changes as a function of maturity and crop load. The concentration increases with fruit maturation and decreases with crop load.

Because of the importance of N on fermentation and fermentation volatiles, it is desirable to determine the N status before fermentation.

The employment of the acid-base titration for determining the total amino-acid concentration is possible only after neutralization of the titratable acidity of the samples (wines or fruit juices) and blockage of the amino groups by reaction with formol base reagent. To decrease the pretitration duration, neutralization of the titratable acidity is performed using two titrants and the pre-titration

stops at 8.2 pH endpoint value. After the reaction with formol base reagent (with pH adjusted between 8.1 and 8.2 pH), in order to ensure it stops at set point pH value, the titration is performed using a low concentrated titrant.

The [HI84533](#) is a potentiometric titrator that use a pH electrode for endpoint. The volume of the titrant dispensing, necessary to reach the endpoint, is used to calculate the formol number. The result is expressed in: meq/100 mL, meq/L or mg/L nitrogen total assimilable.

3. SPECIFICATIONS

Titrator	Range	Low Range:	
		meq/L	2.14 to 28.57 as N
		meq%	0.21 to 2.85 as N
		mg/L	30.0 to 400.0 as N
		High Range:	
		meq/L	21.7 to 71.4 as N
	meq%	2.14 to 7.14 as N	
	mg/L	300 to 1000 as N	
	Resolution	Low Range: 0.01 meq/L; 0.01 meq%; 0.1 mg/L High Range: 0.1 meq/L; 0.01 meq%; 1 mg/L	
Accuracy	3 % of reading or ± 0.1 mg/L @ 25 °C whichever is greater		
Sample volume	10 mL (Low Range) / 5 mL (High Range)		
Titration method	Acid-base titration		
Principle	Endpoint titration: 8.20 pH		
Pump speed	10 mL/min		
Stirring speed	600 rpm		
Log data	Up to 200 samples		
pH Meter	Range	-2.0 to 16.0 pH / -2.00 to 16.00 pH	
	Resolution	0.1 pH / 0.01 pH	
	Accuracy	± 0.01 pH	
	Calibration	1, 2 or 3 calibration points; 4 available buffers (4.01, 7.01, 8.20, 10.01)	
	Temperature compensation	Manual or automatic	
mV Meter	Range	-2000.0 to 2000.0 mV	
	Resolution	0.1 mV	
	Accuracy	± 1.0 mV	
	Log data	Up to 200 samples (pH or mV)	
Temperature	Range	-20.0 to 120.0 °C (-4.0 to 248.0 °F)	
	Resolution	0.1 °C	
	Accuracy	± 0.4 °C without probe error	

Electrode	HI1131B
Temperature Probe	HI7662-T
Environment	0 to 50 °C (32 to 122 °F); max 95% RH non-condensing
Power Supply	12 Vdc power adapter
Dimensions	235 x 200 x 150 mm (9.2 x 7.9 x 5.9")
Weight	1.9 kg (67.0 oz.)

Required Reagents

HI84533-50	Titant for Low and High Range
HI84533-55	Calibration standard

4. PRINCIPLE OF OPERATION

The amino-acidic nitrogen is determined by acidimetric titration after the blockage of the amino groups using an excess of the formol (methanal) solution:

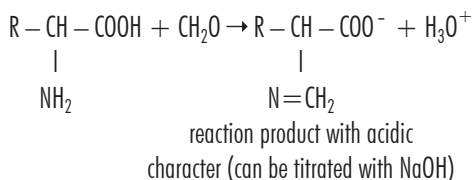

Chemical method steps:

1. Sample (fruit juices or wines) total acidity neutralization, by titration against base strong solution, at $\text{pH} = 8.2$
2. Blockage of the amino-groups with formol solution (37%) adjusted to 8.2 pH.
3. Determination of the amino-acids content by second titration with base low concentration solution until $\text{pH} = 8.2$ (8.1-8.5).

Can see that the formol number titration is consecutive of the fruit juices and wine acidity titration. A potentiometric acid-base titration employs a pH electrode to establish the endpoint of the titration. The [HI84533](#) mini titrator is designed to determine the formol number of the wines and fruit juices. This instrument uses two titrant solutions in acidity neutralization steps (for shorting of the titration time) and one low concentration titrant solution in the step of the formol number determination. The pH of the formol reagent can be adjusted daily at 8.2 pH.

For precise results is important to know the sample volume and the titrant volume and concentration. Preparation of the wine samples must follow the procedure (see TITRATION PROCEDURE section).

It is important to titrate the fresh samples of the fruit juices and wines. In order to increase the precision of the measurement keep the fruit juices in capped vessels (avoid the prolonged air exposure). Formol number determination, as performed on the [HI84533](#) mini titrator, utilizes a simple sample preparation, a high quality dosing pump for titrant, potentiometric endpoint detector and instantaneous computations. To maintain the high precision of the titrator, a simple pump calibration procedure is required. The pump calibration involves the analysis of a known volume of a known solution (standard provided) and compensates for changes in pump dosing that may occur. This procedure should be performed regularly.

5. FUNCTIONAL DESCRIPTION

Front View

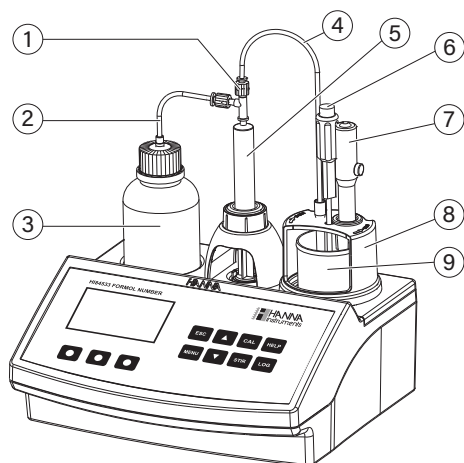

1. Dosing pump valve
2. Aspiration tube
3. Titrant bottle
4. Dispensing tube
5. Syringe
6. Temperature probe
7. pH electrode
8. Electrode holder
9. Beaker

Top View

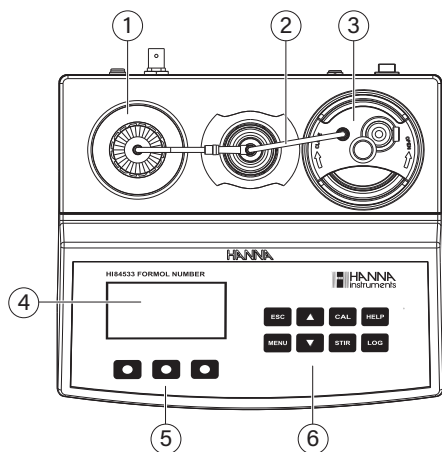

1. Titrant bottle
2. Dispensing tube
3. Electrode holder
4. Liquid Crystal Display (LCD)
5. Functional keys
6. Keypad

Rear View

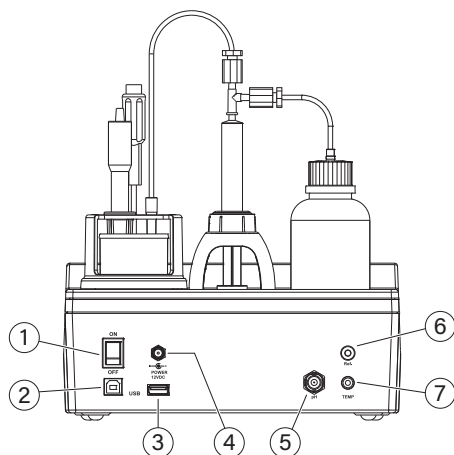





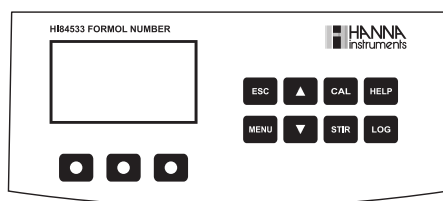



1. Power switch
2. USB connector (PC interface)
3. USB connector (storage interface)
4. Power adapter
5. BNC electrode connector
6. Reference electrode connector
7. Temperature probe connector

Keypad Description



The keypad contains 8 direct keys and 3 functional keys with the following functions:

-  Press the functional key to select the virtual option displayed above it on the LCD.
-  Press **ESC** key to leave the current screen and to return either to the previous screen or to the main screen. In Setup, exits a parameter without changing the value.
-  Press **ARROW** keys to modify the parameters' values, to scroll the information displayed while viewing a help screen or to move between the options from the instrument's Setup
-  Press **CAL** key to access the Electrode and Pump calibration options
-  Press **HELP** key to access/exit the instrument's contextual help
-  Press **LOG** key to save the current mV/pH reading in pH meter mode and the titration result
-  Press **MENU** key to enter Setup, Recall or GLP selection menu, while instrument is in pH or Titration mode
-  Press **STIR** key to start/stop the stirrer

Note: The stirrer starts automatically during pump calibration and titration, it cannot be stopped by pressing STIR key.

Display Indicators

During the instrument's operation information is displayed on the LCD.

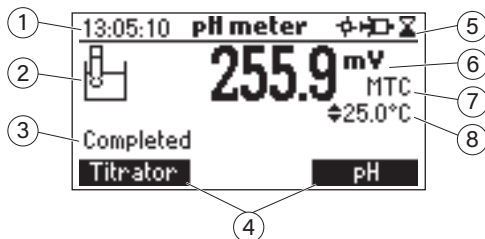

1. Current time and instrument mode information (pH meter or Titrator)
2. pH electrode condition
3. Instrument status
4. Virtual option keys
5. Stirrer and reading status
6. Main reading information
7. pH temperature compensation mode (Manual or Automatic)
8. Temperature reading

Displayed icons:

- ✦ Stirrer running (blinks when stirrer is not working properly.)
- 🔊 Pump running
- ⚡ Unstable reading
- ⚙️ Parameter can be modified

Dosing Pump

The dosing pump is based on a valve that automatically moves the titrant between the titrant bottle and syringe when filling the syringe and between the syringe and sample when dispensing. A replaceable 5 mL plastic syringe is used to limit the amount of titrant used per test to ensure the highest possible accuracy. Before a set of titrations, it is necessary to prime the dosing system.

Note: *Once titrations have been completed, the dosing system should be cleaned with deionized water using the prime feature.*

6. TITRATOR STARTUP

This is a general outline of the steps required to perform a titration. The following topics are expanded upon in each section that follows.

- Place the instrument on a flat table. Do not place the instrument in direct sun light.
- Connect the power adapter to the instrument.
- Turn the instrument on using the power switch from the rear panel of the instrument.
- Set up the instrument. See **SETUP MENU** section for details.
- Connect the pH electrode to the instrument.
- Connect the temperature sensor to the instrument.
- Calibrate the pH electrode.
- Connect the tubes and the valve. See **DOSING PUMP INSTALLATION** section for the procedure.
- Remove the titrant bottle cap and replace it with the bottle cap with tubes. Place the titrant bottle in the appropriate place on the titrator top.
- Prime the syringe. To assure high accuracy, verify there are no air bubbles in the syringe or tubing.
- Calibrate the pump.
- Prepare the sample.

Note: *Different volumes of wine are required based on the concentration. See **TITRATION PROCEDURE** for details.*

- Run a titration and log sample results.

7. SETUP MENU

The titrator's setup menu may be accessed from the main screen (meter or titrator) by pressing the **MENU** key, then **Setup**.

A list of setup parameters will be displayed with currently configured setting.

While in the setup menu, it is possible to modify the instrument's operation parameters.

The **ARROW** keys permit the user to scroll the setup parameters.

Press **HELP** to view the contextual help.

Press **ESC** to return to the main screen.

Concentration Unit

meq/L, meq% or mg/L

Press the corresponding function key to change the option.

Meter setup	
Conc. unit	mg/L
Meas. Range	Low
Calib. Timeout	Disable
pH Resolution	0.1
	meq% meq/L

Measurement Range

Low or High

Use **Low** measurement range for 30.0 - 400.0 mg/L.

Use **High** measurement range for 300 - 1000 mg/L.

To ensure a high accuracy, it is recommended to recalibrate the pump after the valve, titrant or electrode has been changed.

Meter setup	
Conc. unit	mg/L
Meas. Range	Low
Calib. Timeout	Disable
pH Resolution	0.1
	High

Calibration Timeout

Disabled or 1 to 7 days

This option is used to set the number of days before the pH calibration expired warning message is displayed.

Press **Modify** to access the calibration timeout screen.

Use the **ARROW** keys to select the value.

Press **Select** to confirm or **ESC** to return to the setup menu without saving the changes.

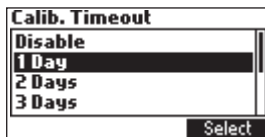
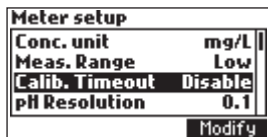

pH Resolution

0.1 or 0.01

Press the displayed virtual option key to change the option.

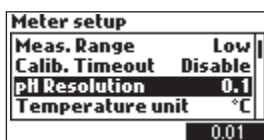

Temperature Unit

°C, °F or K

Press the virtual option key to change the option.

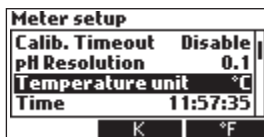

Time

Press the **Modify** key to change the time format.

Press **Format** to switch between 12 hour (am/pm) and 24 hour mode.

Press **→** to highlight the value to be modified. Use the **ARROW** keys to change the value. Press **Accept** to confirm the new value or **ESC** to return to the setup.

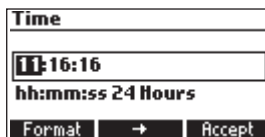
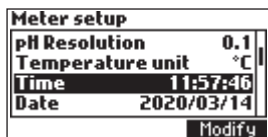

Date

Press the **Modify** key to change the date format.

Press **Format** to cycle between the available date formats.

Press **→** to highlight the value to be modified. Use the **ARROW** keys to change the value. Press **Accept** to confirm the new value or **ESC** to return to the setup.

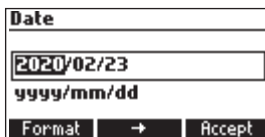
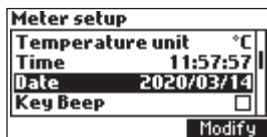

Key Beep

Select **Enable** to activate or **Disable** to deactivate the Key Beep function.

If enabled, a short beep will be heard every time a key is pressed.

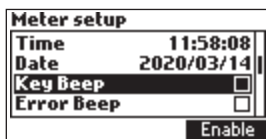

Error Beep

Select **Enable** to activate or **Disable** to deactivate the Error Beep function.

If enabled, a beep will be heard when an error condition occurs.

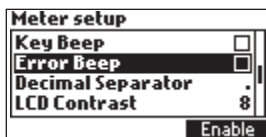

Decimal Separator

This option allows the user to select the symbol used for a decimal separator.

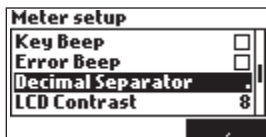

LCD Contrast

This option is used to set the display's contrast.

Press **Modify** to change the display's contrast. The default value is 8.

Use the **ARROW** keys or **←/→** to increase/ decrease the value.

Press **Accept** to confirm the value or **ESC** to return to the setup menu.

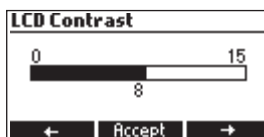
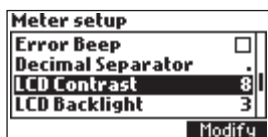

LCD Backlight

Press **Modify** to change the backlight level. The default value is 3.

Use the **ARROW** keys or **←/→** to increase/ decrease the backlight level.

Press **Accept** to confirm or **ESC** to return to the setup menu.

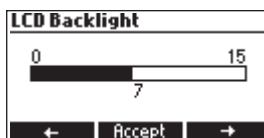
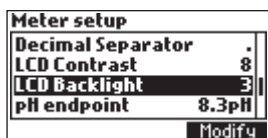

pH Endpoint

Press **Modify** to change the pH endpoint value. The default value is 8.3 pH.

Use the **ARROW** keys to select the value.

Press **Select** to confirm or **ESC** to return to the setup menu without saving the changes.

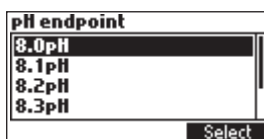
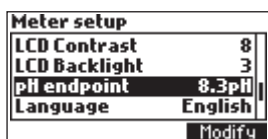

Language

The only available language is English.

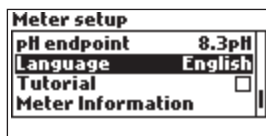

Tutorial

Enable or Disable the Tutorial. This helpful tool offers additional information during calibration and titration.

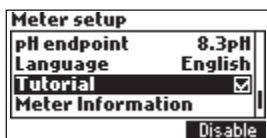

Meter Information

Press **Select** to view the firmware version, language version, mV factory calibration date and time, temperature factory calibration date and time, method version.

Press **ESC** to return to the setup menu.

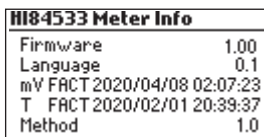
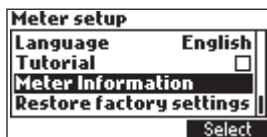

Restore Factory Settings

Press **Select** to restore the factory settings.

Press **Yes** to confirm the restore process or **No** to return without restoring.

Press **ESC** to return to the setup menu.

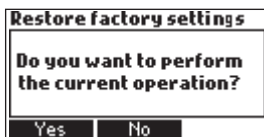
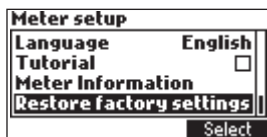

8. GUIDE TO DISPLAY CODES



This screen appears when the instrument is turned on during the initialization process.

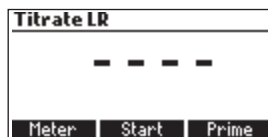

Titration screen display.

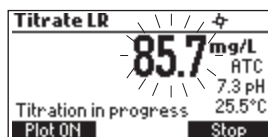

Titration screen when a titration is in progress.

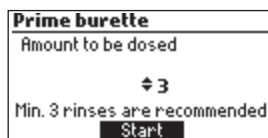

Prime burette screen.



Prime burette screen when the dosing system is running.

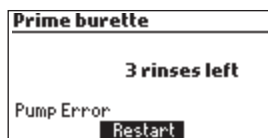

This error message appears when the pump is not working properly. Check the tubing, valve and syringe. Press **Restart** to try again.

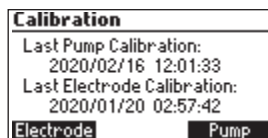

This screen appears when the titrator is in calibration mode. Press **Pump** to calibrate Pump. Press **Electrode** to calibrate pH electrode.

8.1. PUMP CALIBRATION MESSAGES

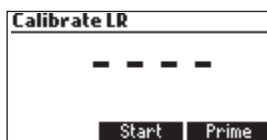

Pump calibration is initiated by pressing the **Start** key.

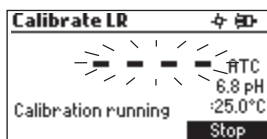

This screen appears while pump calibration is in progress. Press **ESC** or **Stop** key to return to the Pump Calibration screen.

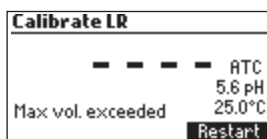

This error message appears during pump calibration when the endpoint can not be reached and the maximum amount of titrant is exceeded. Check standard, electrode and/or dosing system and try again.



The calibration was outside the acceptable limits. Prepare a new standard and try again.

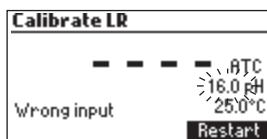

This error message appears when the pH reading exceeds the acceptable input limits ($-2.00 < \text{pH} < 16.00$).

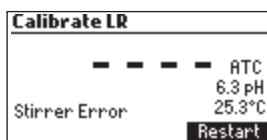

This screen appears when the stirrer is not working properly. Check the stir bar and beaker content. Press **Restart** to try again.

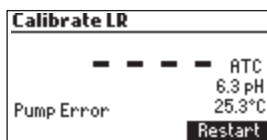

This error message appears when the pump is not working properly. Check the tubing, valve and syringe. Press **Restart** to try again.

8.2. pH CALIBRATION MESSAGES

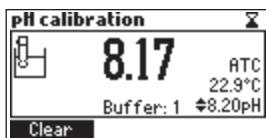

pH calibration mode.

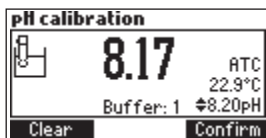

When the reading has stabilized press **Confirm** to accept the calibration or **Clear** to restore the default calibration.



The “Wrong Buffer” message is displayed when the pH value is outside of the acceptable range. Clean the electrode by following the Cleaning Procedure and/or check the buffer concentration before continuing the pH calibration. Press the **ESC** key to exit pH calibration mode.

8.3. TITRATION MESSAGES

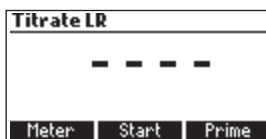

This screen is displayed when the instrument is in titration mode. Press **Start** to begin a titration, **Meter** to enter pH meter mode or **Prime** to enter into the prime function.



This screen is displayed when the instrument in manual preparation phase and is waiting to adjust the pH adding drops of [HI84533-62](#).



When the manual pH adjustment is finished please continue to start the automatically fine adjustment.

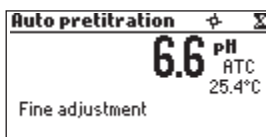

This screen is displayed when the instrument is automatically adjusting the pH to the endpoint value.



The auto pretitration is finished. Press **Continue** to follow the next steps.

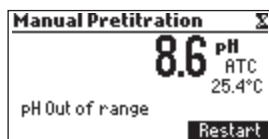

This error message appears when the pH value exceed the acceptable limit for pH adjusting procedure. Press **Restart**.

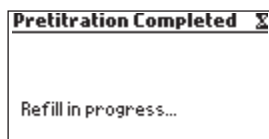

This message appears when the meter is refilling the syringe to be ready for titration.

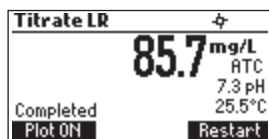

The titration result, expressed as concentration of nitrogen in selected measurement unit, is displayed automatically at the end of the titration. Press **Restart** to start another titration or **ESC** to return to the main screen.

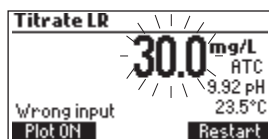

This error message appears when the input reading (pH or temperature) exceeds the input limits. If the pH or temperature values are blinking they are out of range.



This screen appears when the sample concentration is out of range.

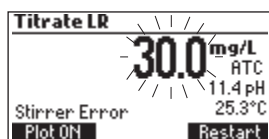

This screen appears when the stirrer is not working properly. Check the stir bar and beaker content. Press **Restart** to try again.

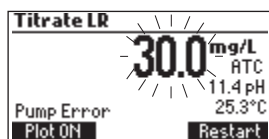

This error message appears when the pump is not working properly. Check the tubing, valve and syringe. Press **Restart** to try again.

9. ELECTRODE PREPARATION

Preparation Procedure

Remove the electrode protective cap.

Do not be alarmed if any salt deposits are present. This is normal with electrodes and they will disappear when rinsed with distilled/deionized water.

During transport tiny bubbles of air may have formed inside the glass bulb. The electrode cannot function properly under these conditions. These bubbles can be removed by “shaking down” the electrode as you would do with a glass thermometer.

If the bulb is dry, soak the electrode in [HI70300](#) Storage solution for at least one hour.

10. ELECTRODE CALIBRATION PROCEDURE

It is recommended to calibrate the instrument frequently, especially if high accuracy is required. The pH electrode should be recalibrated:

- whenever the pH electrode is replaced
- at least once a week, but daily is advised
- after testing aggressive chemicals and after the electrode is cleaned
- when high accuracy is required
- if the pH calibration expired warning is displayed during measurement

Every time you calibrate the instrument use fresh buffers and clean the electrode (see ELECTRODE CONDITIONING & MAINTENANCE).

Procedure

A one, two or three-point calibration can be performed, using four predefined buffers 4.01, 7.01, 8.20 and 10.01 pH. For one point calibration any of the four buffers may be used, 8.20 pH is recommended.

Note: The HI84533 will not accept other pH buffers for calibration.

- Pour small quantities of selected buffer solutions into clean beakers. For accurate calibration use two beakers for each buffer solution, the first one for rinsing the electrode and the second one for calibration.
- Put a magnetic stir bar in the beaker that will be used for calibration.
- Remove the protective cap and rinse the electrode with some of the buffer solution to be used for the first calibration point.
- Put the first beaker with calibration buffer in the beaker holder.
- Place the electrode holder on the top of the beaker and secure it by turning clockwise and press **STIR**.
- Immerse the pH and the temperature probe approximately 2 cm (0.8") into the buffer, paying attention not to touch the stir bar.

To enter Electrode Calibration follow the next steps:

- Press **CAL** key then **Electrode**.
- The electrode calibration screen will be displayed.
- Press **Clear** to delete the previous calibration.

One-Point Calibration

- The 8.20 pH buffer will be selected by default. If necessary, press the **ARROW** keys in order to select a different buffer value.
- The **Σ** (unstable measurement) symbol will be shown on the display until the reading becomes stable.

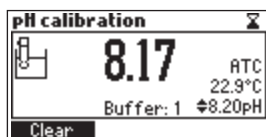

- When the reading is stable and close to the selected buffer, the **Σ** (unstable measurement) symbol will disappear and the Confirm key will become active.

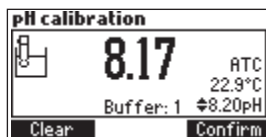

- Press **Confirm** to confirm the calibration or **ESC** to exit calibration.
- After the first calibration point has been confirmed, press **ESC** to exit without performing the second calibration point.

Two-Point Calibration

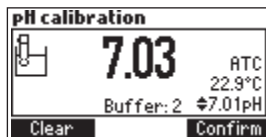

- The calibrated value will be shown on the display and the second expected buffer value will be displayed.



- Remove the electrode holder with electrodes from the top of the beaker.
- Place the second beaker with calibration buffer in the beaker holder. Rinse the electrodes in a beaker containing the second buffer rinsing solution.
- Place the electrode holder (with electrodes) on the top of the beaker and secure it by turning clockwise and press **STIR**.
- If necessary, press the **ARROW** keys in order to select a different buffer value.
- The **Σ** (unstable measurement) symbol will be shown on the display until the reading becomes stable.
- When the reading is stable and close to the selected buffer, the **Σ** (unstable measurement) symbol will disappear and the **Confirm** key will become active.

- Press **Confirm** to confirm the calibration.
- The calibrated value will be shown on the display and the third expected buffer value will be automatically selected.
- After the second calibration point has been confirmed, press **ESC** to exit without performing the third calibration point.

Three-Point Calibration

- Remove the electrode holder with electrodes from the top of the beaker.
- Place the third beaker with calibration buffer in the beaker holder. Rinse the electrodes in a beaker containing the third buffer rinsing solution.
- Place the electrode holder (with electrodes) on the top of the beaker and secure it by turning clockwise and press **STIR**.
- If necessary, press the **ARROW** keys in order to select a different buffer value.
- The  (unstable measurement) symbol will be shown on the display until the reading becomes stable.
- When the reading is stable and close to the selected buffer, the  (unstable measurement) symbol will disappear and the **Confirm** key will become active.
- Press **Confirm** to confirm the calibration. The instrument stores the calibration value and returns to calibration menu, where the date and time for the pH calibration will be updated.

Notes:

A buffer confirmed during the calibration process is removed from the list of available buffers.

If the value measured by the instrument is not close to the selected buffer, a “Wrong Buffer” error message will be shown on the display.



Check if the correct buffer has been used or regenerate the pH electrodes by following the Cleaning Procedure (see ELECTRODE CONDITIONING & MAINTENANCE). If necessary, change the buffer or the electrode.

If the measured offset isn't within the preset limits (± 45 mV), the meter will display the message “Buffer Contaminated” alternatively with “Electrode Dirty/Broken”.

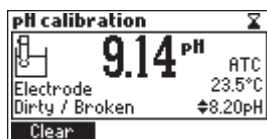
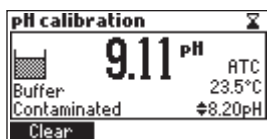

If the computed slope isn't within the preset limits, the meter will display the message "Wrong Slope". If the slope is too high the \blacktriangle symbol will be displayed. If the slope is too low the \blacktriangledown symbol will be displayed.

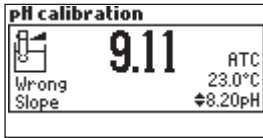

If the "Wrong Old Slope" error message is displayed, an inconsistency exists between the current and the previous (old) calibration. Clear the previous calibration by pressing Clear and proceed with calibration from the current calibration point. The instrument will keep all the confirmed values during the current calibration.



If the temperature reading is out of the defined temperature range of the buffer (0 to 45 °C), the "Wrong Buffer Temperature" error message will be displayed, and the temperature symbol will blink on the display. Calibration cannot be confirmed in this situation.

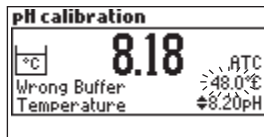

Notes: To clear a previous calibration and to return to the default value, press Clear at any time after entering calibration mode. If Clear is invoked during the first calibration point, the instrument returns to the measurement mode.

The Clear key is displayed only if a previous calibration exists.

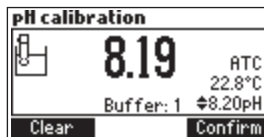

11. pH BUFFER TEMPERATURE DEPENDENCE

Temperature has an effect on pH. The calibration buffer solutions are affected by temperature changes to a lesser degree than normal solutions. During calibration the instrument will automatically calibrate to the pH value corresponding to the measured or set temperature.

TEMP		pH BUFFERS			
°C	°F	4.01	7.01	8.20	10.01
0	32	4.01	7.13	8.38	10.32
5	41	4.00	7.10	8.34	10.24
10	50	4.00	7.07	8.31	10.18
15	59	4.00	7.04	8.27	10.12
20	68	4.00	7.03	8.23	10.06
25	77	4.01	7.01	8.20	10.01
30	86	4.02	7.00	8.17	9.96
35	95	4.03	6.99	8.14	9.92
40	104	4.04	6.98	8.11	9.88
45	113	4.05	6.98	8.08	9.85

During calibration the instrument will display the pH buffer value at 25 °C.

12. DOSING PUMP INSTALLATION

To install the dosing pump follow the procedure below:

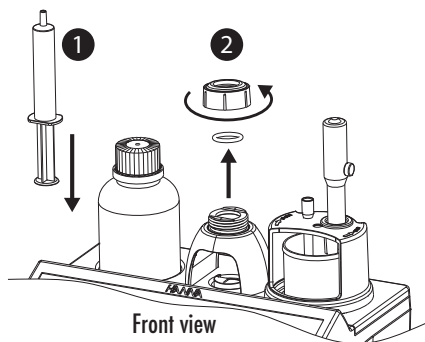

1. Extend the plunger on the 5 mL syringe to its maximum volume.
2. Unscrew the syringe-fixing nut and remove the o-ring.

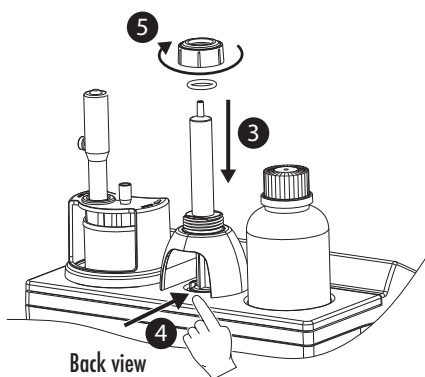

3. Place the syringe in the dedicated spot on the top of the meter.
4. Arrange the bottom of the syringe into the pump holder. Once the syringe is in place lower the barrel until it sits flush on the holder.
5. Put the o-ring and syringe-fixing nut over the syringe. Turn clockwise to secure it in place.

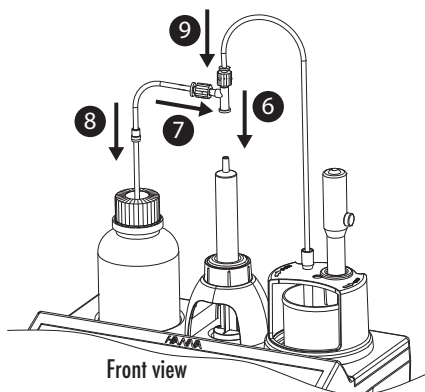

6. Place the valve on top of the syringe. Ensure it fits securely.
7. Insert the aspiration tube into the valve left side.
8. Replace the cap of the titrant bottle with the attached cap.
9. Insert the dispensing tube into the valve top.

13. DOSING PUMP PRIME PROCEDURE

Prime cycle should be performed:

- if there is no titrant in the tip
- whenever the dosing system tubes are replaced
- whenever a new bottle of titrant is used
- before starting a pump calibration
- before starting a series of titrations

The prime cycle is used to fill the syringe before starting a set of titrations.

Two rinse cycles of the syringe are shown in the figure below. The dispensing tube is connected to the top of the valve and the aspiration tube on the left side.

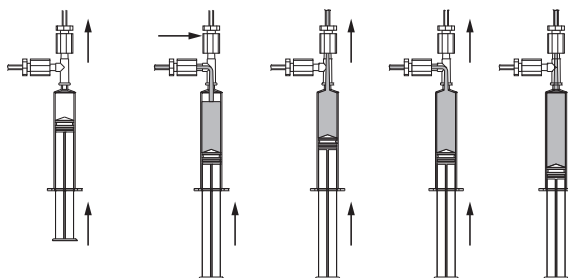

Note: The aspiration tube must be inserted in the titrant bottle. The dosing tip must be placed over a rinse beaker.

- To prime the burette, select **Prime** option from Titration mode.

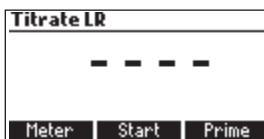

- Adjust the rinses number by pressing the **ARROW** keys and press **Start**.

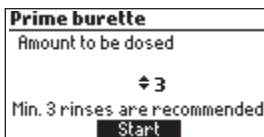

- The number of syringe rinses can be set between 1 and 5 (at least three rinses are recommended to ensure that the air bubbles are completely removed).

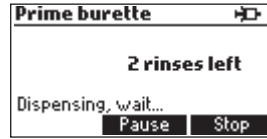
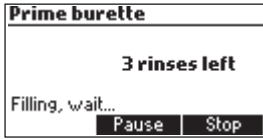

- To pause the prime process press the **Pause** key; to continue press the **Continue** key. To stop the prime process press the **Stop** key.

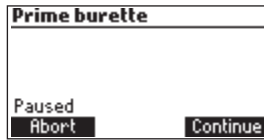

Note: This error message appears when the pump is not working properly. Check the tubing, valve and syringe. Press **Restart** to try again.



14. PUMP CALIBRATION PROCEDURE

The calibration of the pump must be performed every time the syringe, pump tube, the titrant bottle or the pH electrode is changed. It is recommended to perform the pump calibration before each set of titration or after the titrator is left idle for several hours.

- Press **MENU**, select **Setup** and select the corresponding range according to the table below:

Low Range	High Range
30.0 to 400.0 mg/L	300 to 1000 mg/L

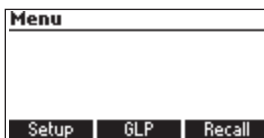

- Verify the electrode has been calibrated in 8.20 pH buffer.

Sample preparation: Use a clean tip and 2000 μ L automatic pipette to precisely add the appropriate amount of HI84533-55 Calibration standard to a clean beaker as indicated below:

Low Range — 2 mL

High Range — 2 mL

Note: Failure to use a clean pipette will result in erroneous readings.

- Fill the beaker up to the 50 mL mark with the distilled or deionized water.

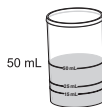

- Press **CAL** key. The instrument displays the date and time of the last electrode calibration, and the last pump calibration.
- Press **Pump** key.

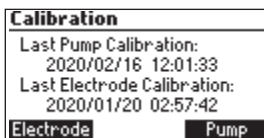

Note: Do not place the tip into the calibration beaker, place the tip over a waste beaker. A small amount of titrant is dispensed when the pump resets.

- Press **Start**, wait for the syringe to refill.



- Place the stir bar in the beaker and put the beaker in the mini titrator top.
- Place the probe holder on the top of the beaker and secure it by turning clockwise.

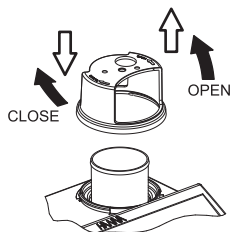

- Rinse the pH electrode with deionized water and immerse into the sample until the reference junction is completely submerged. Be sure that the tip of the electrode is not hitting the stir bar. If necessary, additional distilled or deionized water can be added.
- Insert the dosing tip into the titrant tube sleeve. It is critical that the tip be immersed approximately 0.25 cm (0.1") into the solution being titrated.

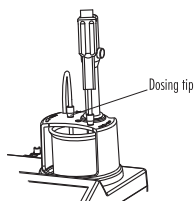

Press **Continue** to begin the calibration and **Stop** to abort it.

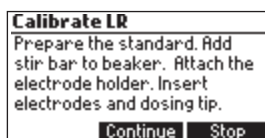

At the end of the calibration, "Calibration completed" appears on display. To repeat the calibration press **Restart** or **ESC** to return to the main screen.

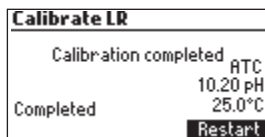

Notes:

If temperature probe is not connected, Manual Temperature Compensation is used and MTC appears on the right side of the screen. If Automatic Temperature Compensation is in use, the ATC appears on the right side of the screen.

If an erroneous situation is encountered during the calibration, an error message is displayed and the calibration can be restarted by pressing Restart. Prepare a new standard, rinse electrode, temperature probe and dosing tip and try again.



If the calibration doesn't complete and the max titrant volume of titrant is reached, an error message will be displayed. The calibration can be restarted by pressing Restart. Prepare a new standard, rinse electrode, temperature probe and dosing tip and try again.

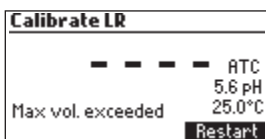

This error message appears when the pH reading exceeds the acceptable input limits ($-2.00 < \text{pH} < 16.00$).

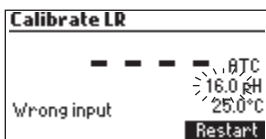

This screen appears when the stirrer is not working properly. Check the stir bar and beaker content. Press Restart to try again.

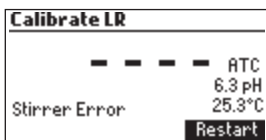

This error message appears when the pump is not working properly. Check the tubing, valve and syringe. Press Restart to try again.

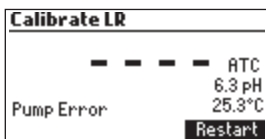

15. TITRATION PROCEDURE

- For best accuracy, before taking any measurement, ensure that the pump is calibrated on the selected range following the description in PUMP CALIBRATION PROCEDURE section.

Note: Verify that the instrument has been calibrated (pH and pump) before performing any titrations.

- Refer to select the desired endpoint pH value and order measurement settings in Setup (see SETUP MENU).
- Select the corresponding range according to the table below:

Low Range	High Range
30.0 to 400.0 mg/L	300 to 1000 mg/L

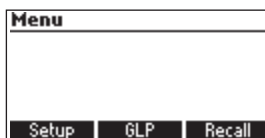

Sample preparation: Use a clean tip and 2000 μ L automatic pipette to precisely add the appropriate amount of wine sample to a clean beaker as indicated below:

Low Range — 10 mL

High Range — 5 mL

Note: Failure to use a clean pipette will result in erroneous readings.

- Fill the beaker up to the 50 mL mark with distilled or deionized water.
- Press **Titrate**.

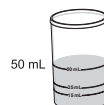

Note: Do not place the tip into the sample beaker. Place the tip over a waste beaker. A small amount of titrant is dispensed when the pump resets.

- Press **Start** to begin a titration.

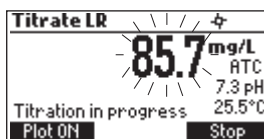
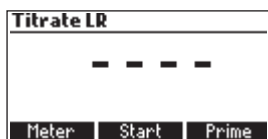

- Place the stir bar in the beaker and put the beaker in the mini titrator top.

- Place the probe holder on the top of the beaker and secure it by turning clockwise.

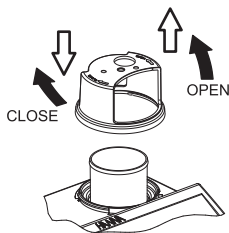

- Rinse the pH electrode with deionized water and immerse into the sample until the reference junction is completely submerged. Be sure that the tip of the electrode is not hitting the stir bar.
- Insert the dosing tip into the titrant tube sleeve. It is critical that the tip be immersed approximately 0.25 cm (0.1") into the solution being titrated.

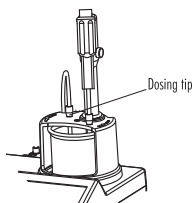

Press **Continue** to begin the titration and **Stop** to abort it.

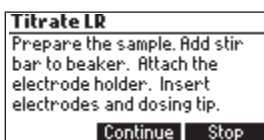

- The instrument will start the manual pretitration procedure to adjust the sample pH to set value.

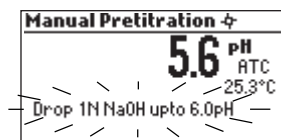

- Add drop by drop from [HI84533-62](#) waiting to have stable pH between drops until the "Rough pH adjustment ended" message appear.



- In case of high pH difference between measured and set endpoint values continue to add drops slowly to get as close as possible value.
- When the pH value exceed the limit that could affect the final accuracy, the “pH Out of range” message will be displayed and the procedure must be restarted.



- Press **Continue** and the meter enter in Automatic pretitration mode for a fine automatic pH adjustment.

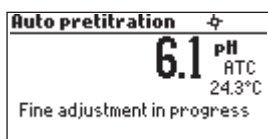

- When the sample pH reach the set point, the automatic titration is stopped and the following screen appears.



- Place the dosing tip over a waste beaker.
- Press **Continue** and the syringe will be refilled for final titration.
- Add 4 mL of **HI84533-61** Formol Base reagent to sample.

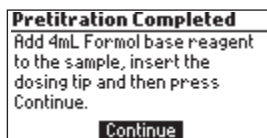

- Insert the dosing tip into the titrant tube sleeve. It is critical that the tip be immersed approximately 0.25 cm (0.1”) into the solution being titrated.

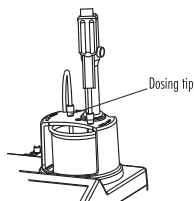

- Press **Continue** to begin the titration.



- The instrument will continuously update the concentration on the display. The value will be displayed blinking. When the reading is under range “----” symbol appears blinking.

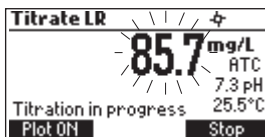
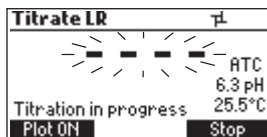

- The titration curve can be visualized during a titration by pressing **Plot ON**. Press **Plot OFF** to exit this mode.

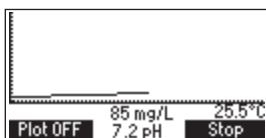

- At the end of the titration the concentration is displayed in mg/L nitrogen total assimilable. The titration curve can be viewed by pressing **Plot ON**. Press **Plot OFF** to exit this mode.

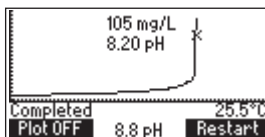
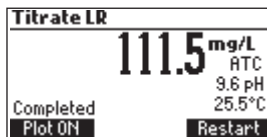

- Press **LOG** to record the concentration value into the instrument’s memory. A message will be displayed for a few seconds indicating the amount of free log space. Up to 200 log samples can be recorded in the instrument’s memory.

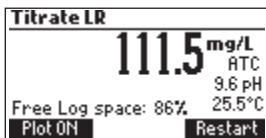

- Press **Restart** to begin a new titration or **ESC** to return to the titration menu.

- If the concentration exceeds the range limits, the exceeded range limit will be displayed blinking. Another titration can be started by pressing **Restart**.



- “Wrong input” error message appears when the input reading (pH, temperature) exceeds the specified limits. The pH or temperature value and the concentration will blink indicating an error.

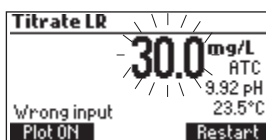

- This screen appears when the stirrer is not working properly. Check the stir bar and beaker content. Press **Restart** to try again.

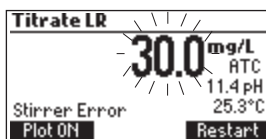

- This error message appears when the pump is not working properly. Check the tubing, valve and syringe. Press **Restart** to try again.

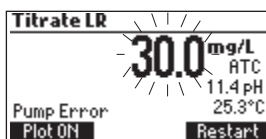

15.1. TIPS FOR AN ACCURATE MEASUREMENT

The instructions listed below should be followed carefully to ensure measurements are conducted with the highest possible accuracy and precision.

- It is critical that the tip be immersed in the solution being titrated (approximately 0.25 cm).
- Use a clean, volumetric pipette to measure and transfer the necessary volume of wine sample into the titration beaker.
- Calibrate the pump prior to each series of titrations.
- Calibrate the pump if the meter is left idle for several hours.
- Analyze the wine sample immediately after it is obtained.
- Clean the electrode with [HI700635](#) or [HI700636](#) cleaning solutions specially designed for the wine industry.

15.2. VIEW / DELETE TITRATOR RECORDED DATA

Press **MENU** then **Recall** to access the **Titration** logs.

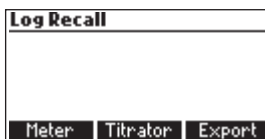
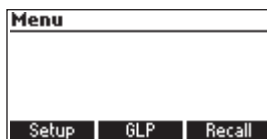

When an external USB storage device is connected, the **Export** key is displayed. It saves the meter and titration logs in two text format files on the storage device.

Press **Meter** or **Titration** to view the respective logs.

The instrument will display a list of all the records stored in the log.

Use the **ARROW** keys to scroll the stored records list.

If the saved concentration was out of range, the "<" or ">" symbols are displayed in front of the reading.

	mg/L	Date
1	< 300	2020/03/13
2	111.5	2020/03/13
3	> 400.0	2020/03/13
4	< 300	2020/03/13

Buttons: Delete, Del.All, Info

Press **Delete** to delete the selected log from the memory.

Press **Del.All** to delete all records.

Press **Info** to see detailed information about the highlighted record.

The selected record data and the titration curve data file name are displayed.

Record number: 2	
2020/03/13	15:09:08
111.5mg/L	25.5°C
3781134.txt file	
Plot	Export

When a USB storage device is connected, the **Export** key is displayed. It saves the titration curve data as a text file on the storage device using the displayed file name.

Use the **ARROW** keys when \blacktriangle is displayed to scroll between the log records.

Press **ESC** to return to the previous screen.

Record number: 2	
2020/03/13	15:09:08
111.5mg/L	25.5°C
3781134.txt file	
Plot	\blacktriangle

Press **Plot** to visualize the titration curve or **ESC** to return to the previous screen. On the titration curve, the endpoint volume and pH are displayed. The titration data (Total Titrant Volume on the x-axis and pH on the y-axis) can be scanned through with the dotted line by using the **ARROW** keys.

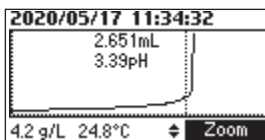

To zoom on the titration curve, press **Zoom**.

If **Delete** or **Del.All** is pressed, the instrument will ask for confirmation.

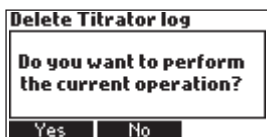

Press **Yes** to delete the record or **No** to return to the previous screen. Deleting a single record will renumber the list of records.

If the titrator log is empty, the message “No records available!” will be displayed.

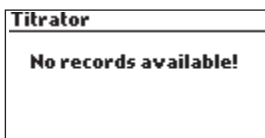

15.3. TITRATOR GLP INFORMATION

Press **MENU** then **GLP**.

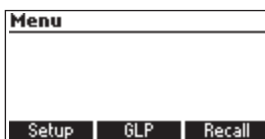

From this screen it is possible to select the **Electrode** or the **Pump** GLP.

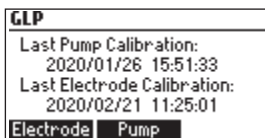

Press **Pump** to view the pump's last calibration time, date and slope.

Last pump calibration LR
Date: 2020/01/26
Time: 15:51:33
Slope: 101.44%

If a calibration hasn't been performed, the message "Not Calibrated" will be displayed.

Last pump calibration LR
Not Calibrated

16. pH MEASUREMENT

The HI84533 can be used as a pH meter for direct measurements.

Verify that the instrument has been calibrated before taking pH measurements. Set the instrument to pH meter. From titrator mode press **Meter** until pH units are displayed.

If an electrode calibration hasn't been performed, or the number of days exceeds the calibration time out value set, the message "CAL DUE" will blink on the left side of the display (see Calibration Timeout option in SETUP MENU for details).

If "CAL DUE" is displayed, perform an electrode calibration.

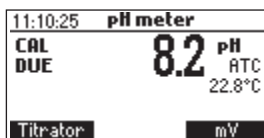

Press **MENU** to access the instrument's menu.

Press **HELP** to view the contextual help, every time you need additional information.

Press **STIR** to start/stop the stirrer.

Press **Titrator** to enter titration mode.

Press **CAL** to access the calibration menu.

Press **LOG** to save the current reading. A message indicating the free log space will be displayed for a few seconds.

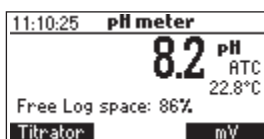

In order to take pH measurements, follow the next steps:

- Submerge the pH electrode 2 cm (0.8") and the temperature probe into the sample to be tested and stir gently. Make sure the PTFE junction is completely submersed. Allow time for the electrode to stabilize. When the reading becomes stable, the  (unstable measurement) symbol will disappear.

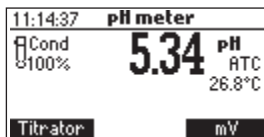

- If the pH reading is less than -2.00 pH or greater than 16.00 pH, the closest full-scale value will be displayed blinking.

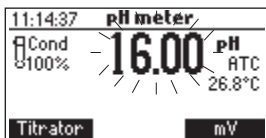

During pH measurements with stirrer on, the stirrer icon will be displayed. In case of a stirrer malfunction, the stirrer will stop and the stirrer icon will start blinking.

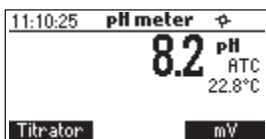

If measurements are taken successively in different samples, it is recommended to rinse the electrodes thoroughly with deionized or distilled water and then with some of the next sample to prevent cross-contamination.

The pH measurement is affected by temperature. In order to have accurate pH measurements, the temperature effect must be compensated for. To use the Automatic Temperature Compensation (ATC) feature, connect and submerge the HI7662-T temperature probe into the sample as close as possible to the electrode and wait for a few seconds. The "ATC" message will be shown on the display. Automatic Temperature Compensation will provide pH corrected values for the measured temperature. If Manual Temperature Compensation (MTC) is desired, the temperature probe must be disconnected from the instrument.

The default temperature of 25 °C (77 °F) or the last temperature reading will be displayed, preceded by the \blacklozenge symbol and the "MTC" message.

The temperature can be adjusted with the **ARROW** keys (from -20.0 to 120.0 °C).

16.1. VIEW / DELETE RECORDED pH DATA

To view or delete previously logged pH records, press **MENU** then **Recall** to access the pH logs.

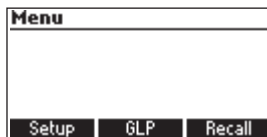

When an external USB storage device is connected, the **Export** key is displayed. It saves the meter and titrator logs in two text format files on the storage device.

Press **Meter** or **Titrator** to view the respective logs.

The instrument will display a list of all the records stored in the log.

If the saved mV/pH measurements are out of range, the “<” or “>” symbols are displayed in front of the reading.

	mV/pH	Date
1	5.24pH	2020/05/22
2	> 16.00pH	2020/05/22
3	< -2000.0mV	2020/05/22
4	-100.0mV	2020/05/22

Delete Del.All Info

Use the **ARROW** keys to scroll the list of records.

Press **Delete** to delete the selected log from the memory.

Press **Del.All** to delete all the records.

Press **Info** to see detailed information about the highlighted record.

Record number: 1	
2020/05/22	16:01:48
5.24 pH	25.1°C
Offset: 0.2mV	
Slope: 100.1%	

⬆

Use **ARROW** keys when ⬆ is displayed to scroll between the records.

Press **ESC** to return to the previous screen.

If **Delete** or **Del.All** is pressed, the instrument will ask for confirmation.

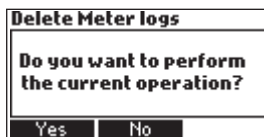
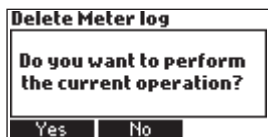

Press **Yes** to delete the record or **No** to return to the previous screen without deleting.

Deleting a single record will renumber the list of records.

If the pH log is empty, the message “No records available!” will be displayed.

Meter
No records available!

16.2. pH METER GLP INFORMATION

The pH meter GLP screen displays the last pH calibration data.

To view this information, press **MENU** key then **GLP**.

Press **Electrode** to view information regarding electrode calibration.

Last Electrode Calibration	
Date: 2020/05/31	8.20
Time: 05:13:04 PM	7.01
Cal Expire: 3 Days	4.01
Offset: 1.4mV	
Slope: 102.9%	
Electrode Condition: 100%	

GLP contains a set of information regarding electrode calibration. The following items are included in electrode GLP: the time and date of the last calibration, offset, slope, electrode condition, calibration timeout and the calibration buffers. The buffers displayed in video inverse mode are from the previous calibration.

If a calibration hasn't been performed, the message "Not Calibrated" will be displayed.

Last pump calibration LR
Not Calibrated

17. PC INTERFACE & DATA TRANSFER

Data stored on the meter with the LOG function during pH/mV measurement and titrations can be transferred from the meter to a USB stick using the **Export** function from the log recall menu. Two text files are transferred on the USB stick. These files can be used for further analysis on a PC. The logged data can also be transferred from the instrument to the PC using a USB cable.

Connect the USB cable and the following screen will be displayed.



Press **Meter** to generate the text file with Meter log data.

Press **Titrator** to generate the text file with Titrator log data.

Press **Plot** to generate the text files with Titration Plots.

The generated files are now visible and can be used for further analysis.

If the instrument has no logged Meter or Titrator records, the PC connected screen is displayed.



18. ELECTRODE CONDITIONING & MAINTENANCE

Storage Procedure

To assure a quick response time, the glass bulb should be kept moist and not allowed to dry out. Replace the solution in the protective cap with a few drops of [HI70300](#) or [HI80300](#) Storage solution. Follow the Preparation Procedure section before taking measurements.

Note: *Never store the pH electrode in distilled or deionized water.*

Periodic Maintenance

Inspect the electrodes and the cables. The cable used for connection to the instrument must be intact and there must be no broken insulation on the cable or cracks on the electrode stem or bulb. Connectors must be perfectly clean and dry. If any scratches or cracks are present, replace the electrode. Rinse off any salt deposits with water.

pH Cleaning Procedure

General: Soak in Hanna Instruments [HI7061](#) or [HI8061](#) General cleaning solution for approximately 30 minutes

Important: *After performing any of the cleaning procedures, rinse the electrode thoroughly with distilled or deionized water and soak the electrode in [HI70300](#) or [HI80300](#) Storage solution for at least 1 hour before use. Recalibrate electrode before taking measurements.*

19. TROUBLESHOOTING GUIDE

SYMPTOMS	PROBLEM	SOLUTION
Slow response/excessive drift.	Dirty pH electrode.	Soak the electrode tip in HI7061 cleaning solution for 30 minutes. Refill with fresh fill solution.
Reading fluctuates up and down (noise).	Clogged/dirty junction. Low electrolyte level (refillable pH electrodes only). Cable connection.	Soak the electrode tip in HI7061 cleaning solution for 30 minutes. Refill with fresh fill solution. Check cable connection to meter and verify protective cap is off.
While in pH reading mode, -2.00 or 16.00 pH is displayed blinking.	Reading out of range.	Check cable connection to meter and verify protective cap is off. Check the quality of the sample. Clean the electrodes. Refill with fresh fill solution.
The meter does not accept the pH buffer solution for calibration.	Broken pH electrode.	Follow electrode cleaning procedure. If the error persists, replace the electrode or contact the vendor.
The pump calibration can't be performed.	Broken pump tubing. Wrong or contaminated pump calibration solution. Broken pH electrode.	Verify tubing, valve, syringe are intact and solution passes when pump is primed and no air bubbles are present. Check the pump calibration solution. Verify electrode is calibrated in fresh pH buffers. Prepare another standard, prime the pump and restart the calibration.
The temperature probe is connected, but the meter displays "MTC".	Broken temperature probe.	Replace temperature probe.

SYMPTOMS	PROBLEM	SOLUTION
After a titration the following is displayed blinking: Low Range, High Range.	Broken electrode. Instrument not calibrated. Wrong range selected. Concentration out of range.	Check/clean the electrode. Recalibrate the instrument (pH and pump). Use care during sample preparation. Change selected range.
At startup the meter displays the HANNA logo permanently.	One of the keys is stuck.	Check the keyboard or contact the vendor.
"Error xx" message is displayed.	Internal error.	Power off the meter and then power it on again. If the error persists, contact the vendor.
"Stirrer error" message is displayed at the end of pump calibration or titration.	Stirrer not functioning properly.	If the error persists, contact the vendor.
Non-spinning stirrer icon blinking in pH calibration and meter mode.	Stirrer not functioning properly.	If the error persists, contact the vendor.
"Pump error" message is displayed.	Check the tubing, valve and syringe.	If the error persists, contact the vendor.
At startup the meter displays "Methods corrupted".	The method file was corrupted.	Contact the vendor.

20. ACCESSORIES

REAGENTS

HI84533-50	Formol number titrant, 230 mL
HI84533-55	Formol number calibration standard, 120 mL
HI84533-60	Formol number hydrogen peroxide reagent, 30 mL
HI84533-61	Formol number base reagent, 230 mL
HI84533-62	Formol number pH adjustment reagent, 30 mL

pH CALIBRATION SOLUTIONS

HI7004M	pH 4.01 buffer solution, 230 mL
HI7007M	pH 7.01 buffer solution, 230 mL
HI70082M	pH 8.20 buffer solution, 230 mL
HI7010M	pH 10.01 buffer solution, 230 mL

ELECTRODES

HI1131B	pH electrode
HI7662-T	Temperature probe

ELECTRODE FILL SOLUTION

HI7082	Electrode fill solution, 30 mL (4 pcs.)
--------	---

ELECTRODE STORAGE SOLUTION

HI70300L	Electrode storage solution, 500 mL
----------	------------------------------------

ELECTRODE CLEANING SOLUTION

HI70635L	Cleaning solution for wine deposits, 500 mL
HI70636L	Cleaning solution for wine stains, 500 mL

OTHER ACCESSORIES

HI70500	Tube set with cap for titrant bottle, tip and valve
HI7100051/8	115 Vac to 12 Vdc, 800 mA
HI7100061/8	230 Vac to 12 Vdc, 800 mA
HI731319	Stir bar (10 pcs., 25 x 7 mm)
HI731342	Automatic pipette 2000 μ L
HI731352	Tips for 2000 μ L automatic pipette (4 pcs.)
HI740036P	100 mL beaker (10 pcs.)
HI740236	5 mL syringe for mini titrator (6 pcs.)
HI920013	PC connection cable

CERTIFICATION

All Hanna Instruments conform to the **CE European Directives**.



Disposal of Electrical & Electronic Equipment. The product should not be treated as household waste. Instead hand it over to the appropriate collection point for the recycling of electrical and electronic equipment which will conserve natural resources.

Ensuring proper product disposal prevents potential negative consequences for the environment and human health. For more information, contact your city, your local household waste disposal service, or the place of purchase.



RECOMMENDATIONS FOR USERS

Before using this product, make sure it is entirely suitable for your specific application and for the environment in which it is used. Any variation introduced by the user to the supplied equipment may degrade the instrument's performance. For your and the instrument's safety do not use or store it in hazardous environments.

WARRANTY

HI84533 is warranted for two years against defects in workmanship and materials when used for its intended purpose and maintained according to instructions. Electrodes and probes are warranted for a period of six months. This warranty is limited to repair or replacement free of charge. Damage due to accidents, misuse, tampering or lack of prescribed maintenance is not covered.

If service is required, contact your local Hanna Instruments Office. If under warranty, report the model number, date of purchase, serial number (see engraved on the back of the meter) and the nature of the problem. If the repair is not covered by the warranty, you will be notified of the charges incurred. If the instrument is to be returned to Hanna Instruments, first obtain a Returned Goods Authorization number from the Technical Service department and then send it with shipping costs prepaid. When shipping any instrument, make sure it is properly packed for complete protection.

Hanna Instruments reserves the right to modify the design, construction or appearance of its products without advance notice.

World Headquarters

Hanna Instruments Inc.
Highland Industrial Park
584 Park East Drive
Woonsocket, RI 02895 USA
www.hannainst.com



MAN84533

Printed in ROMANIA