

---

# QUICK START GUIDE

## HI901 Wine

# AUTOMATIC POTENTIOMETRIC TITRATOR

Revision 1.00

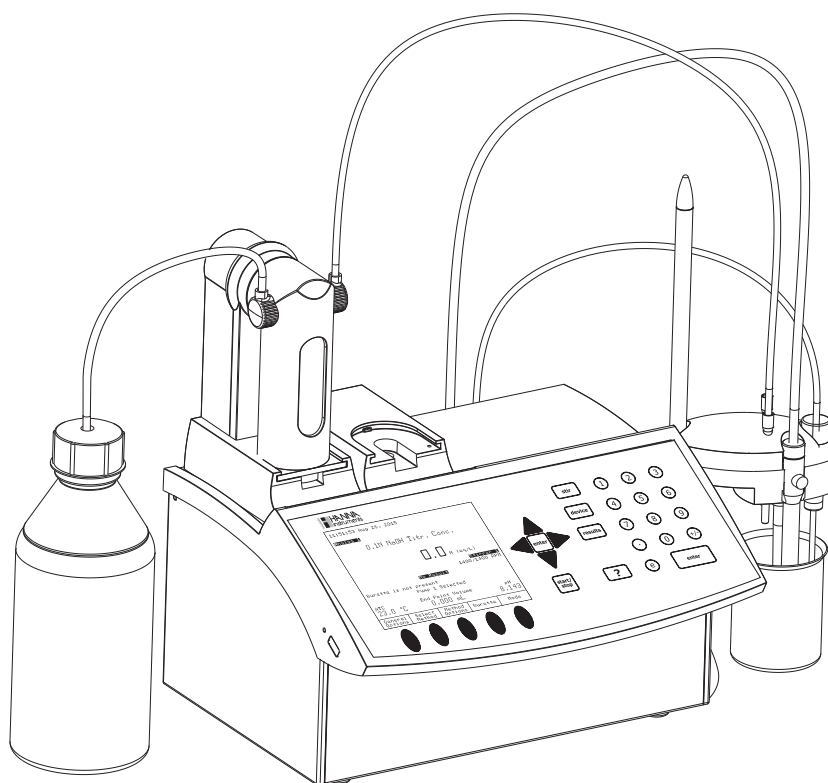

[www.hannainst.com](http://www.hannainst.com)

---

## QUICK START GUIDE

---

**Dear customer,**

Congratulations on choosing a Hanna Instruments product.

This guide has been written for **HI901W** Winetitrators with color display, USB interface, and software version **1.00** and higher.

Please read this Quick Start Guide carefully before using the instrument. This guide will provide you with the necessary information for the correct use of the instrument.

The purpose of this guide is to present a quick overview of setting up and using the instrument.

For detailed information illustrating the extensive capabilities of your Titrator, please refer to the Instruction Manual.

© 2018 Hanna Instruments

All rights are reserved. Reproduction in whole or in part is prohibited without the written consent of the copyright owner, Hanna Instruments Inc., 584 Park East Drive, Woonsocket, Rhode Island 02895, USA.

Contents

**INTRODUCTION ..... 4**

**SAFETY MEASURES ..... 5**

**TITRATOR CONNECTIONS ..... 6**

**USER INTERFACE ..... 7**

**HOW TO SELECT YOUR LANGUAGE ..... 8**

**HOW TO USE THE CONTEXTUAL HELP ..... 8**

**METHODS ..... 8**

**HOW TO CALIBRATE A pH ELECTRODE ..... 9**

**HOW TO PERFORM A TITRATION ..... 10**

# QUICK START GUIDE

---

## INTRODUCTION

The **HI901W** automatic Titrator is designed to perform a wide variety of potentiometric titrations with high accuracy, flexibility and reproducibility, allowing the user to obtain both accurate results and high-speed analysis.

The Titrator can perform fixed endpoint or equivalence point titrations and direct measurements by measuring the pH/mV/ISE and temperature of the sample.

Reports and methods can be transferred to a PC via a USB storage device, saved to a USB storage device or printed directly from the Titrator. An external monitor and keyboard can also be attached for added convenience.

### How can I find certain information?

- The **Quick Start Guide** will help the user learn how to operate the Titrator within a short period of time.
- The **Instruction Manual** provides a complete description of the operating principles (user interface, general options, methods, titration/direct reading mode, pH, mV and ISE mode, maintenance, etc.).
- The **Titration Theory** outlines the basic concepts of titration.
- The contextual **Help** screens contain detailed explanations of every screen.

### SAFETY MEASURES

The following safety measures must be followed:

1. Never connect or disconnect the pump assembly or other peripheral with the Titrator turned on.
2. Verify that the burette and the attached tubing are assembled correctly.
3. Always check that the titrant bottle and the titration beaker are placed on a flat, stable surface.
4. Always wipe up spills and splashes immediately.
5. Avoid the following environmental working conditions:
  - Severe vibrations
  - Direct sunlight
  - Atmospheric relative humidity above 95% non-condensing
  - Environment temperatures below 10°C and above 40°C
  - Explosion hazards
6. Have the Titrator serviced by qualified service personnel only.

# QUICK START GUIDE

## TITRATOR CONNECTIONS

### Front View

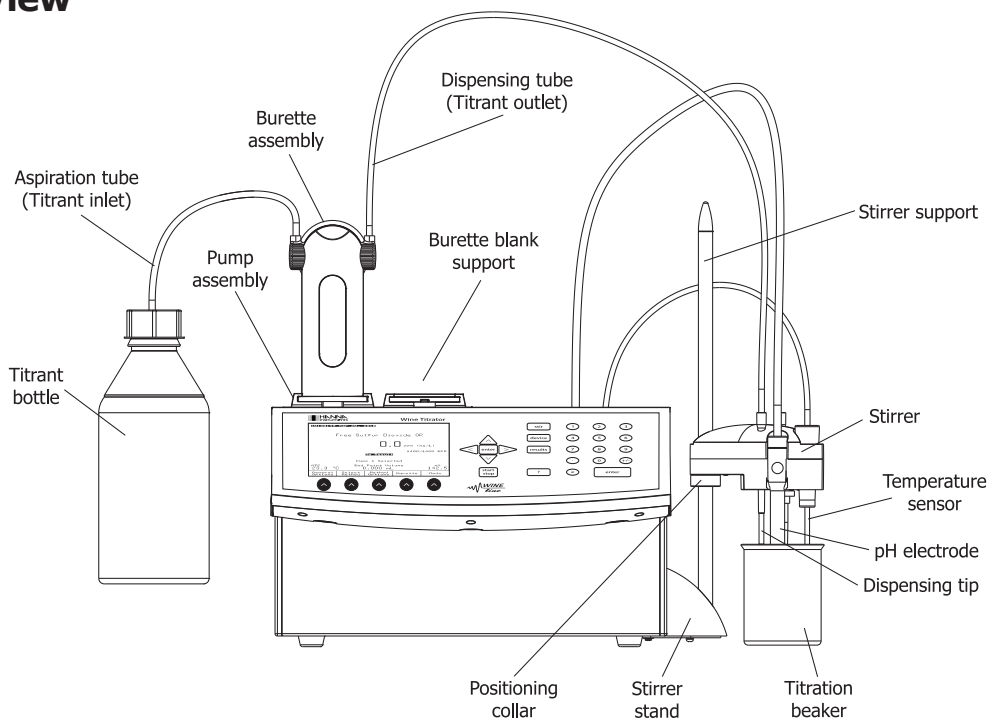

### Rear View

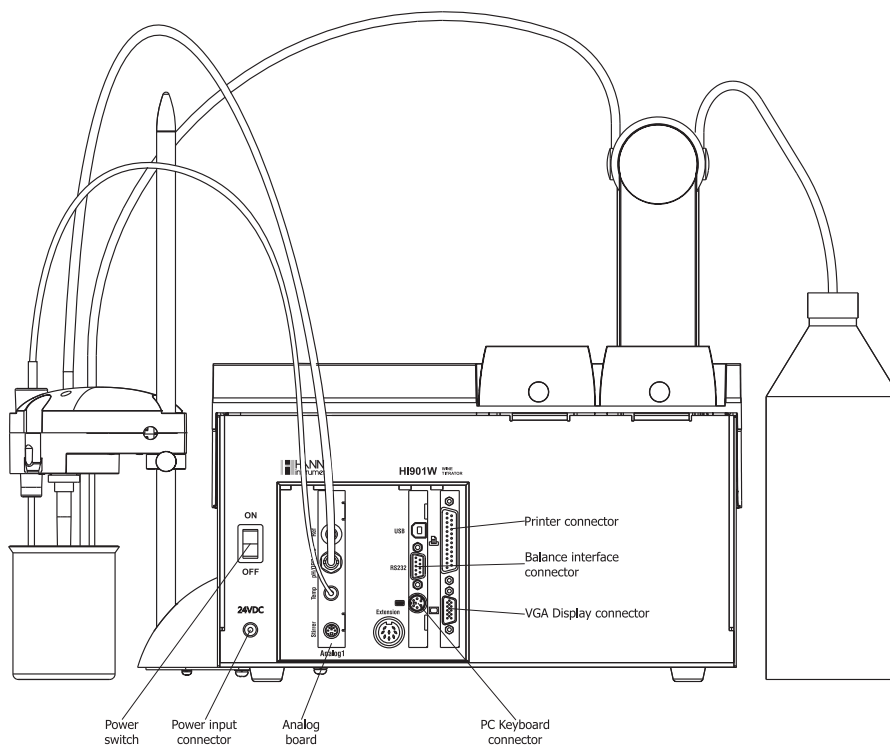

## USER INTERFACE

### Keypad

The titrator's keypad has 29 keys grouped in five categories, as follows:

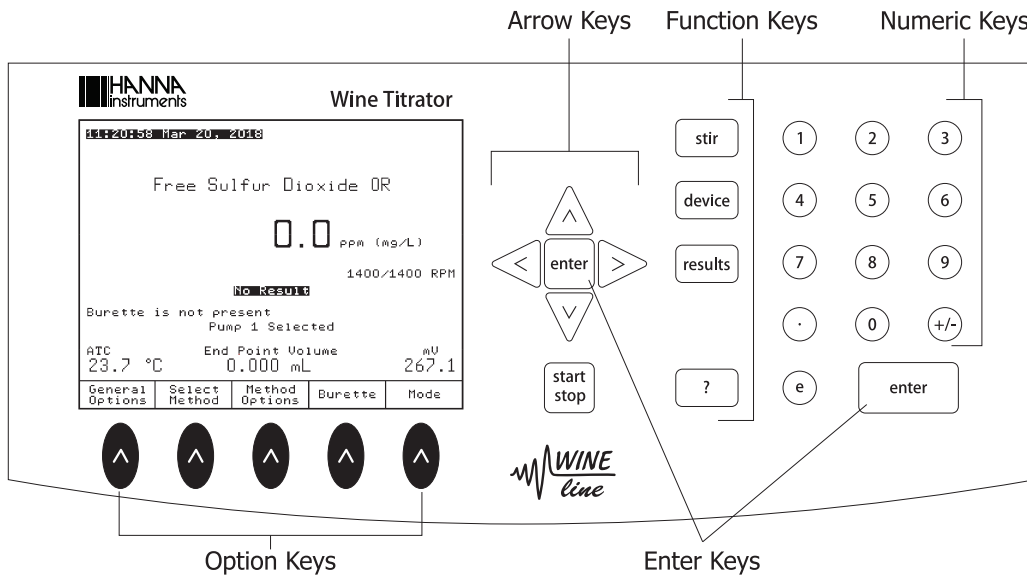

### Display

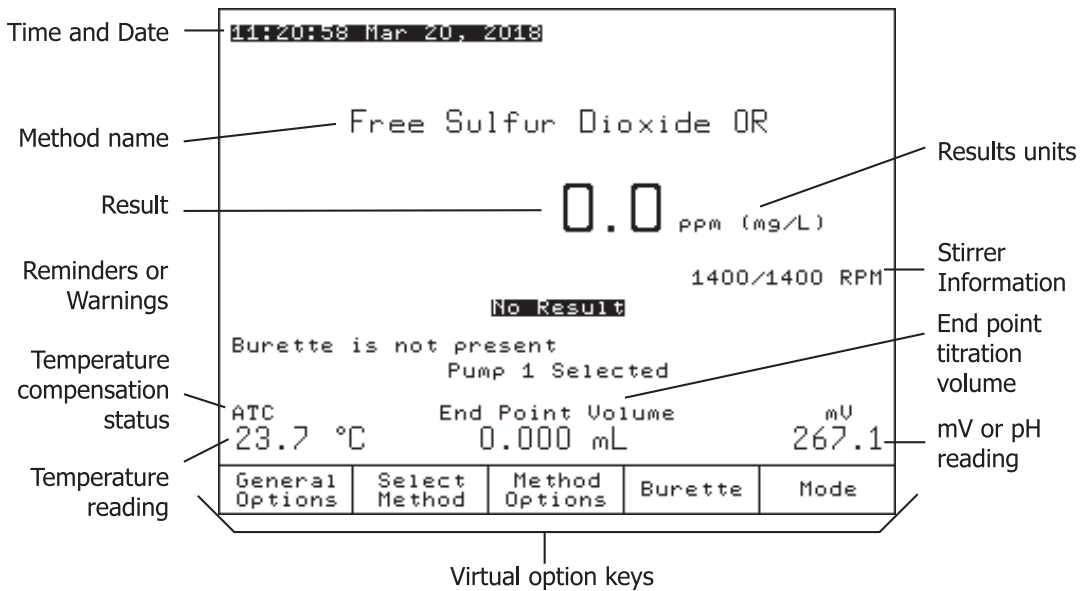

The user interface contains several screens. In each screen, many information fields are present at the same time. The information is displayed in an easy-to-read manner. Virtual option keys describe the function performed when the corresponding option key is pressed.

## QUICK START GUIDE

### HOW TO SELECT YOUR LANGUAGE

To change the language, press **General Options** from the main screen. Highlight the *Language* option and then press **Select**. Using the  $\triangle$  and  $\nabla$  keys, select the language from the options listed in the **Set Language** screen and press **Select**. Restart the Titrator in order to apply the new language setting.

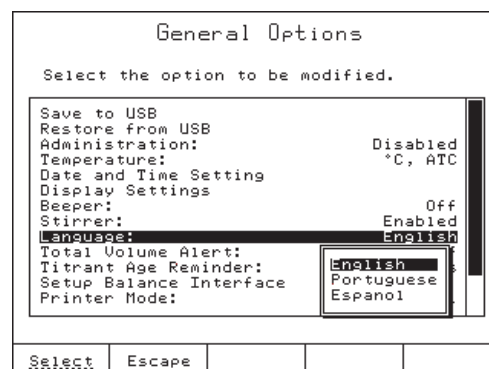

### HOW TO USE THE CONTEXTUAL HELP

Information about the Titrator can be easily accessed by pressing **?**. The contextual help can be accessed at any time and it provides useful information about the current screen.

### METHODS

The **HI901W** Titrator can store up to 100 methods (standard and user).

#### Standard Methods

Each Titrator is supplied with a package of standard methods for wine analysis.

#### User-Defined Methods

User defined methods allow the user to create and save their own methods. Each new method is based on an existing method which is altered to suit a specific application.



### HOW TO CALIBRATE A pH ELECTRODE

To enter pH calibration mode, press , then , then

#### PREPARATION

Pour small quantities pH 4.01, pH 7.01 and pH 10.01 buffer solutions into clean beakers. If possible, use plastic beakers to minimize any EMC interferences.

For accurate calibration and to minimize cross-contamination, use two beakers for each buffer solution: one for rinsing the electrode and one for calibration.

#### CALIBRATION PROCEDURE

Three buffer entry types are available: Automatic, Semi-automatic and Manual Selection.

The default option is Manual Selection.

- If the instrument has been previously calibrated and calibration was not cleared, the old calibration can be cleared by pressing .

**Note:** *It is very important to clear calibration history when a new electrode is used. Most errors and warning messages that appear during calibration depend on calibration history.*

- Use the  or  to select pH 4.01 buffer solution.
- Use the second beaker of pH 4.01 buffer solution to rinse the pH electrode, temperature probe and propeller stirrer.
- Immerse the pH electrode, temperature probe and propeller stirrer in the pH 4.01 buffer solution. The pH electrode's bulb must be completely immersed in the buffer solution and the reference junction needs to be 5-6 mm below the surface. Add additional buffer if necessary.
- Press  to turn on the propeller stirrer.
- Once the reading has stabilized, press  to update the calibration.
- Repeat this procedure for pH 7.01 and 10.01 buffer solutions.
- Press  to accept and exit pH calibration mode.

## QUICK START GUIDE

---

### HOW TO PERFORM A TITRATION

#### Required Solutions

- Titrant - 500 mL of 0.1 M (mol/L) Sodium Hydroxide (NaOH) in a titrant bottle.
- Sample - 0.1 mol/L Hydrochloric Acid (HCl).
- Distilled or deionized water.

**Note:** Analytical grade reagents and water should be used for accurate results.

#### Priming the Burette



- Insert the aspiration tube in the titrant bottle and the dispensing tube in a waste beaker.
- From the main screen press .
- Highlight the *Prime Burette* option and then press .
- Enter the number of burette rinses. At least 3 rinses are recommended.
- Press  to start.
- The message "Executing..." will be displayed.

**Note:** Make sure you have continuous liquid flow inside the burette. For accurate results, the aspiration tube, the dispensing tube and the syringe must be free of air bubbles.

#### Method Selection

For this analysis, we will use the **HI1009EN Neutralization w/ NaOH**.

To select this method:

- Press . Use the  and  keys to highlight **HI1009EN Neutralization w/ NaOH**.
- Press .

## Setting Method Parameters

To display the method parameters, press . The **View/Modify Method** screen will be displayed.

Only certain parameters can be changed.

For this titration, the NaOH titrant concentration and the size of the HCl sample need to be entered.

To accomplish this:

- Highlight *Titrant Conc.* option, then press . The **Titrant Concentration** screen will be displayed.
- Enter the correct value, then press .
- Highlight *Analyte Size* option, then press .
- Enter the volume of the sample (e.g.: 5 mL), then press .
- Press , highlight *Save Method* option and then press .

Titrant Concentration				
Enter the titrant concentration.				
<input style="width: 100px;" type="text" value="0.1000"/> M (mol/L)				
ACCEPT	Escape	Delete Digit		

Sample Volume				
Enter the initial sample volume in milliliters.				
<input style="width: 100px;" type="text" value="5"/> mL				
This volume will be used when Fixed sample size is selected.				
ACCEPT	Escape	Delete Digit		

## Setup Titration Report

Users can select the information that is stored for each titration.

To setup the titration report, follow the procedure below:

- From the main screen, press . The **Data Parameters** screen will be displayed.
- Highlight *Setup Titration Report* and press .
- Mark the fields to be included in the titration report with the "\*" symbol. Use the  and  keys to highlight a field and  /  to toggle the field.
- Press  to save the customized report.

## QUICK START GUIDE

### Preparing the Sample

- Add 50 to 65 mL of distilled / deionized water to the titration beaker.
- Use a pipette or burette to add 5.0 mL of the sample (0.1M Hydrochloric Acid (HCl)) into the same beaker.
- Slide the stirrer assembly up.
- Place the beaker under the stirrer assembly.
- Lower the stirrer assembly until it rests on the positioning collar.
- Adjust the height of the stirrer assembly so it is as close as possible to the bottom of the beaker.
- Adjust the level of the sample solution with distilled / deionized water so that the pH electrode bulb is completely immersed in the sample solution and the reference junction of the electrode is 5-6 mm below the surface.

**Note:** Make sure that the pH electrode, temperature probe and propeller do not touch each other or the beaker.

### Performing a Titration

- From the main screen, press . You will be prompted to enter the analyte size. Enter 5 mL and press . The Titrator will start the analysis.
- At the end of the titration, the message "Titration Completed" will appear on the display with the final concentration of the analyte in the sample and the equivalence endpoint volume.

### Understanding the Displayed Information

During a titration the following screen is displayed:

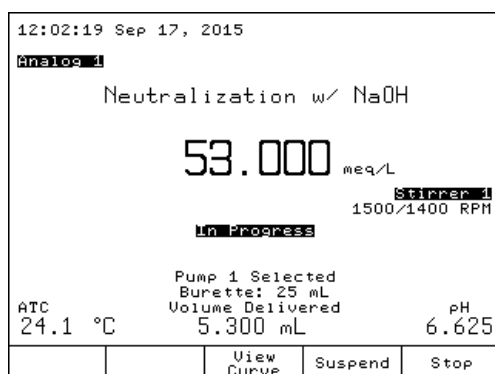

## Viewing Graph During Titration

After a few doses are dispensed, View Curve will become active. Press View Curve to display the real-time titration graph.

The curves displayed are plots of the pH and the 1<sup>st</sup> derivative versus Titrant Volume (for details, see the Instruction Manual).

The two graphs are scaled to fit in the same screen window. Press Select Trace to change the y-axis scale to either the pH values or the 1<sup>st</sup> derivative values.

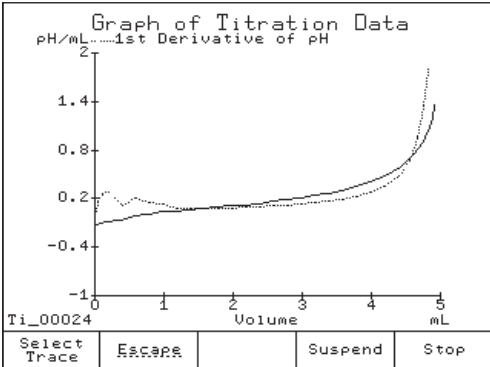
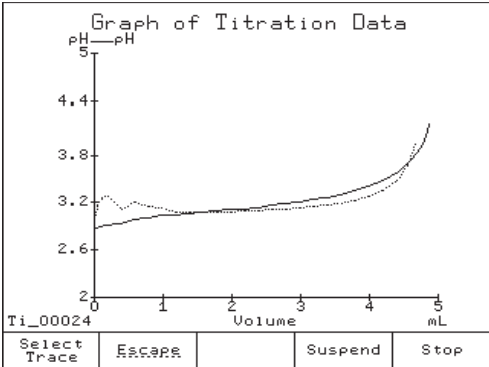

## Titration Termination

The titration is normally terminated when the first equivalence endpoint is detected according to the selected algorithm. To ensure the correct detection and interpolation of the equivalence endpoint, the Titrator will dispense a few additional doses after the endpoint was reached. The titration result can be displayed either in the main screen or in the **Graph of Titration Data** screen:

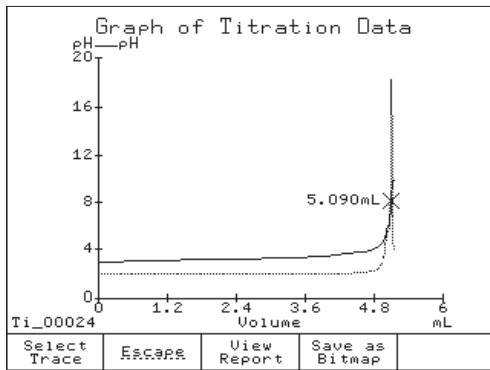
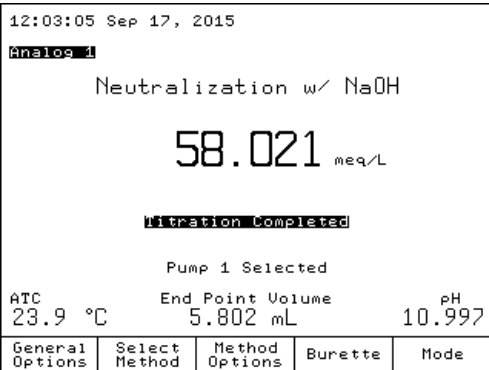

When the titration has ended, the Titrator will display the equivalence endpoint volume and the final concentration of the analyte together with the **Titration Completed** message.

To view the titration graph and/or results, press results.

When the titration ends, an "x" will mark the endpoint on the pH versus titrant volume curve in the **Graph of Titration Data** screen. The value of the endpoint volume is also displayed next to the endpoint.

# QUICK START GUIDE

## Results

The results obtained from a titration are stored in a report file that can be viewed, transferred to a USB Storage Device or PC and printed.

### Viewing the last titration data

- From the main screen, press **results**. The **Data Parameters** screen will be displayed.
- From the **Data Parameters** screen highlight the *Review Last Analysis Report* option and press **Select**. The **Review Result** screen will be displayed.
- Use the **Page Up** and **Page Down** keys to display information related to the last titration performed. See *Titration Report* on next page.

### Printing the titration report

Connect a DOS / Windows-compatible parallel printer directly to the DB 25-pin connector located on the back of the Titrator.

**Note:** When connecting the printer, please turn off the Titrator and the printer.

Printing out the report:

- From the **Review Report** screen, press **Print Report**.
- During the information transfer to the printer, the message "Printing" will be displayed on the screen.
- Press **Escape** to return to the **Data Parameters** screen.
- Press **Escape** again to return to the main screen.

### Saving data to USB Storage Device

This feature allows saving the results of titrations or pH / mV / ISE logging sessions on a USB storage device.

- From the main screen, press **General Options**, the **General Options** screen will be displayed.
- Highlight the *Save Files to USB Storage Device* option using the **△** and **▽** keys.
- Insert the USB storage device into the USB socket.
- Press **Select**, the **List of Files on Titrator** screen will be displayed.
- Use the **◀** or **▶** keys to select the file type: "report files".
- Press **Copy All** to transfer all available reports to the USB storage device, or highlight the name of the report file to be transferred and press **Copy File**.

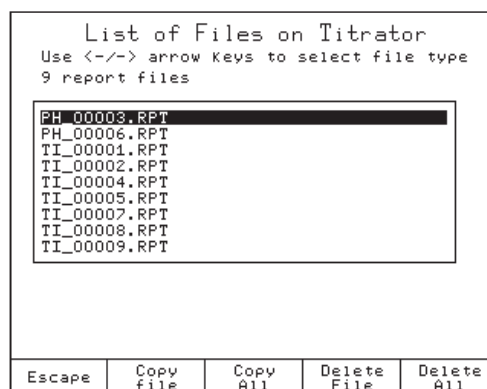

- Transferring a report file will automatically transfer the corresponding log file and titration graph (\*.BMP file if available).
- Press Escape to return to the **General Options** screen.
- Press Escape again to return to the main screen.

## Titration report

While scrolling with the Page Up and Page Down keys, the fields below can be seen on the Titrator display or printed. The same information is available on the saved report file (Ti\_00007.rpt in this example).

```
HI901W - Titration Report

Method Name:           Neutralization w/NaOH
Time & Date:           12:02:58 Mar 22, 2018
Report ID:             Ti_00007

Standardization Data
Buffer Potential Efficiency Temperature
Time and Date
4.006pH    169.9mV    100.7%    22.0°C A
           10:20 Mar 22, 2018
7.020pH    -7.8mV     96.5%    22.0°C A
           10:23 Mar 22, 2018
10.040pH  -178.6mV    96.5%    21.9°C A
           10:25 Mar 22, 2018

GLP & Instrumentation Data
Sample Name:           Sample HCl-1
Company Name:          Hanna Instruments
Operator Name:
Electrode Name:       HI 1131 NO -2
Field 1:              Any text
Field 2:              Any text
Field 3:              Any text
Titrator Software Version      v3.00
Base Board Software Version:   v2.00
Pump 1 Software Version:      v1.4
Base Board Serial Number:     01040409
Analog Board Serial Number:   30040409
Pump 1 Serial Number:        70040207
Factory Calibration Date:     Jan 28, 2018

Method Parameters
Name:                   Neutralization w/NaOH
Method Revision:       1.0
Analog Board:         Analog1
```

# QUICK START GUIDE

```

Stirrer Configuration:
  Stirrer:                      Stirrer 1
  Stirring Speed:                1400 RPM
Pump Configuration:
  Titrant Pump :                 Pump 1
Dosing Type:                     Dynamic
  Min Vol:                       0.050 mL
  Max Vol:                       0.500 mL
  delta E:                       20.000 mV
End Point Mode:                  pH 1EQ point, 1st Der
Recognition Options:
  Threshold:                     50 mV/mL
  Range:                         NO
  Filtered Derivatives:          NO
Pre-Titration Volume:            0.000 mL
Pre-Titration Stir Time:         15 Sec
Measurement Mode:                Signal Stability
  delta E:                       1.0 mV
  delta t:                       2 Sec
  Min wait:                      2 Sec
  Max wait:                      15 Sec
Electrode Type:                  pH
Calculations:                    Sample Calc. by Volume
Dilution Option:                Disabled
Titrant Name:                    NaOH
Titrant Conc.:                  0.1000 M (mol/L)
Analyte Size:                    5.000 mL
Analyte Entry:                   Manual
Maximum Titrant Volume:          20.000 mL
Stirring Speed:                  1400 RPM
Potential Range:                 -2000.0 to 2000.0 mV
Volume/Flow Rate:                25 mL / 50.0 mL/min
Signal Averaging:                1 Reading
Significant Figures:             XXXXX
M (mol/L) -> M (mol/L)

```

```

V mol mol
-*-*--

```

```

  L mol
-----

```

```

mL L
--*---

```

```

  1000mL

```

```

V = volume dispensed in liters
0.100 mol/L -> titrant conc.
1.000 mol/mol -> (sample/titrant)
5.000 mL -> sample volume

```

Nr	Volume[ml]	mV	pH	Graphic	Temp[°C]		Time
0	0.000	235.2	2.857	0.0	19.1	A	00:00:00
1	0.050	234.6	2.866	-10.2	19.0	A	00:00:21
2	0.100	233.9	2.880	-15.8	19.1	A	00:00:27
3	0.200	232.2	2.908	-16.7	19.1	A	00:00:39
4	0.390	231.1	2.928	-6.0	19.1	A	00:00:45



# QUICK START GUIDE

5	0.590	228.6	2.970	-12.3	19.1	A	00:01:04
6	0.790	226.9	3.000	-8.7	19.1	A	00:01:20
7	0.990	225.5	3.024	-6.9	19.1	A	00:01:37
8	1.190	224.7	3.038	-4.0	19.1	A	00:01:43
9	1.390	223.9	3.051	-4.0	19.1	A	00:01:49
10	1.590	223.0	3.066	-4.3	19.1	A	00:01:55
11	1.790	222.1	3.082	-4.6	19.1	A	00:02:01
12	1.990	221.2	3.098	-4.6	19.1	A	00:02:06
13	2.190	220.1	3.115	-5.1	19.1	A	00:02:11
14	2.390	219.0	3.134	-5.6	19.1	A	00:02:17
15	2.590	217.8	3.155	-6.0	19.1	A	00:02:23
16	2.790	216.5	3.177	-6.6	19.1	A	00:02:29
17	2.990	215.1	3.202	-7.3	19.1	A	00:02:34
18	3.190	213.4	3.231	-8.4	19.1	A	00:02:40
19	3.390	211.5	3.263	-9.3	19.1	A	00:02:46
20	3.590	209.2	3.302	-11.4	19.1	A	00:02:51
21	3.790	206.6	3.348	-13.4	19.1	A	00:02:57
22	3.990	203.2	3.406	-16.8	19.1	A	00:03:02
23	4.190	198.9	3.479	-21.4	19.1	A	00:03:08
24	4.390	193.1	3.578	-29.0	19.1	A	00:03:14
25	4.556	186.2	3.697	-41.7	19.1	A	00:03:20
26	4.670	179.6	3.810	-57.8	19.1	A	00:03:25
27	4.753	172.9	3.925	-81.2	19.1	A	00:03:31
28	4.812	166.4	4.036	-110.0	19.2	A	00:03:37
29	4.856	160.1	4.144	-143.5	19.2	A	00:03:43
30	4.889	153.7	4.253	-189.9	19.2	A	00:03:54
31	4.915	147.1	4.367	-259.9	19.2	A	00:04:00
32	4.934	141.0	4.471	-322.7	19.2	A	00:04:11
33	4.949	135.2	4.571	-388.0	19.2	A	00:04:17
34	4.964	127.5	4.702	-512.0	19.2	A	00:04:23
35	4.979	117.3	4.877	-680.0	19.2	A	00:04:29
36	4.994	104.2	5.102	-875.3	19.2	A	00:04:35
37	5.009	87.9	5.381	-1088.0	19.2	A	00:04:41
38	5.024	69.6	5.695	-1221.3	19.2	A	00:04:50
39	5.039	51.2	6.010	-1226.0	19.2	A	00:05:08
40	5.054	31.6	6.344	-1301.3	19.2	A	00:05:36
41	5.069	7.3	6.762	-1625.3	19.2	A	00:06:07
42	5.084	-37.9	7.557	-3010.0	19.2	A	00:06:38
43	5.099	-120.0	9.024	-5476.0	19.2	A	00:06:48
44	5.114	-144.7	9.464	-1642.7	19.2	A	00:06:54
45	5.129	-158.2	9.705	-900.7	19.2	A	00:07:01
46	5.144	-168.1	9.883	-664.0	19.2	A	00:07:08

### Titration Results

Method Name: Neutralization w/NaOH  
 Time & Date: 12:02:58 Mar 22, 2018  
 Analyte Size: 5.000 mL  
 End Point Volume: 5.090 mL  
 pH Equivalence Point: 8.131  
 Results: 0.10 meq/L  
 Initial & Final pH: 2.857 to 9.884  
 Titration Duration: 7:09 [mm:ss]  
 Operator Name:

Analyst Signature: \_\_\_\_\_

QS 901W  
03/18

---

# INSTRUCTION MANUAL

## HI901W

# AUTOMATIC TITRATOR FOR WINE ANALYSIS

Revision 1.00

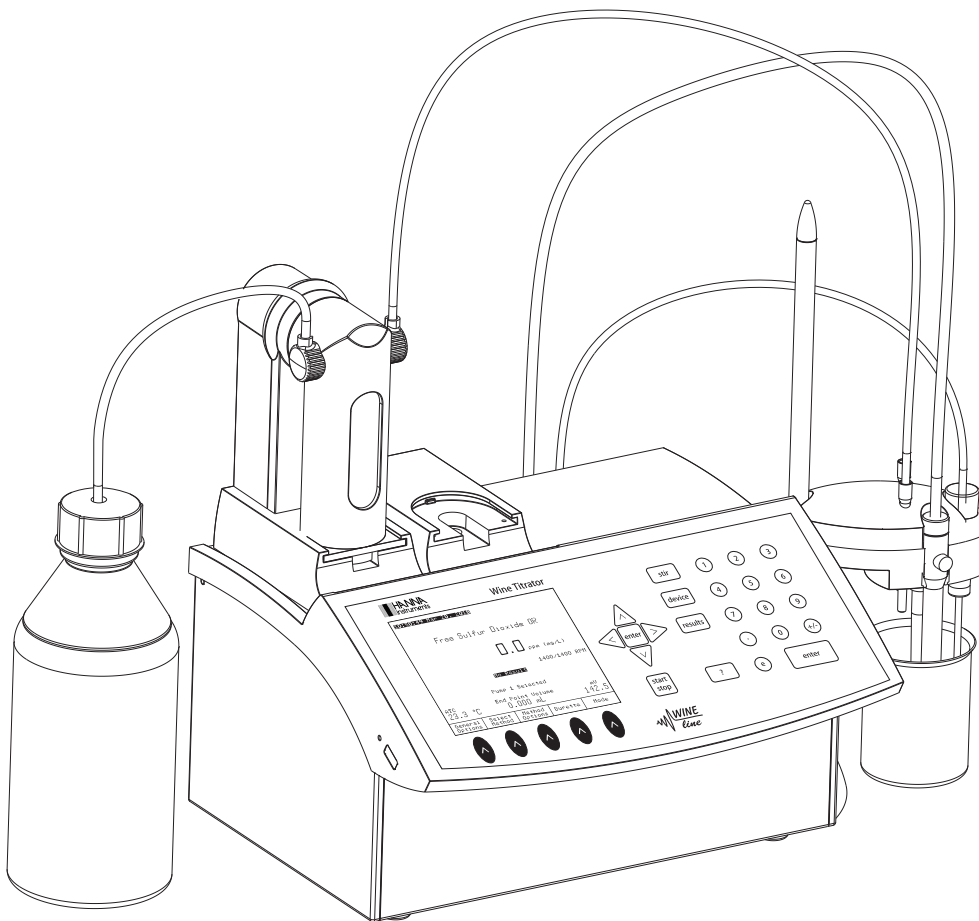

 **HANNA**<sup>®</sup>  
instruments

[www.hannainst.com](http://www.hannainst.com)

---



---

## **TABLE OF CONTENTS**

<b>Chapter 1.</b>	<b>INTRODUCTION</b>
<b>Chapter 2.</b>	<b>SETUP</b>
<b>Chapter 3.</b>	<b>USER INTERFACE</b>
<b>Chapter 4.</b>	<b>GENERAL OPTIONS</b>
<b>Chapter 5.</b>	<b>METHODS</b>
<b>Chapter 6.</b>	<b>TITRATION MODE</b>
<b>Chapter 7.</b>	<b>pH MODE</b>
<b>Chapter 8.</b>	<b>mV MODE</b>
<b>Chapter 9.</b>	<b>ISE MODE</b>
<b>Chapter 10.</b>	<b>AUXILIARY FUNCTIONS</b>
<b>Chapter 11.</b>	<b>MAINTENANCE, PERIPHERALS</b>
<b>Appendix 1.</b>	<b>TECHNICAL SPECIFICATIONS</b>
<b>Appendix 2.</b>	<b>ACCESSORIES</b>

---

---

**Dear customer,**

Thank you for choosing a Hanna Instruments Product.

This instruction manual has been written for the **HI901W** Titrator product.

Please read this instruction manual carefully before using the instrument. This manual will provide you with the necessary information for the correct use of the instrument.

© 2018 Hanna Instruments

All rights are reserved. Reproduction in whole or in part is prohibited without the written consent of the copyright owner, Hanna Instruments Inc., 584 Park East Drive, Woonsocket, Rhode Island, 02895, USA.

---

## 1 INTRODUCTION

**HI901W** is an automatic titrator for wine analysis with high accuracy, great flexibility and repeatability.

The Titrator is designed to perform a variety of wine titrations, allowing the user to obtain both good results and high speed analysis.

The main attributes of this Titrator is:

Flexibility	Support up to 100 titration methods (standard and user defined) Preloaded Wine Analysis Method Pack User-customizable titration / analysis methods (equivalence point, fixed pH/mV end point)
High accuracy	Precise dosing system (under 0.1% accuracy) Precise mV and pH measurements ( $\pm 0.1$ mV and $\pm 0.001$ pH accuracy) Interpolated end point volume Titrant age and standardization reminders
Repeatability	Powerful built-in algorithms for equivalence point detection (first derivative and second derivative detection algorithms, filtered derivatives option, settable range for equivalence point detection) Fixed end point mV or pH
Quick results	Pre-defined titration methods Pre-titration dosing feature Dynamic / Linear dosing feature
Complete report	The results are displayed directly in the selected units Titration graph can be displayed on the screen and saved as a bitmap User customized reports can be printed, saved or transferred to PC
Direct measurements	The Titrator can also be used for precise mV, pH, ISE and temperature measurements Report of data logging is available for direct measurements
Research grade meter	pH/ mV/ ISE and Temperature meter with Cal Check Up to five calibration points Data logging (log-on-demand or lot logging)
Graphical display	5.7" (320 x 240 pixels) color display with easy-to-view text and graphs Integrated help screens Clearly displayed warning and error messages Self-diagnosis features for peripheral devices including the pump, burette and stirrer

This manual provides information regarding installation and functionality of the Titrator and refined operation suggestions.

Before using the Titrator, it is recommended you become familiar with its various features and functionality.





## Chapter 2. Contents

<b>2</b>	<b>SETUP .....</b>	<b>2 -3</b>
<b>2.1</b>	<b>Unpacking .....</b>	<b>2 -3</b>
<b>2.2</b>	<b>Safety Measures .....</b>	<b>2 -4</b>
<b>2.3</b>	<b>Installation .....</b>	<b>2 -5</b>
2.3.1	Titrator Front View .....	2 -5
2.3.2	Titrator Rear View .....	2 -5
2.3.3	Titrator Left-side View .....	2 -6
2.3.4	Titrator Assembly .....	2 -6
2.3.4.1	Assembling Stirrer Stand and Support .....	2 -6
2.3.4.2	Attaching Stirrer .....	2 -7
2.3.4.3	Connecting the Pump .....	2 -8
2.3.4.4	Attaching Burette Blank Support .....	2 -9
2.3.4.5	Attaching the Burette .....	2 -9
2.3.4.6	Electrical Connections .....	2 -10



**2 SETUP**

**2.1 Unpacking**

The Titrator and the accessories are shipped in a single box containing:

<b>ITEM</b>	<b>QUANTITY</b>
1 Titrator .....	1 pc.
2 Pump Assembly .....	1 pc.
3 Burette Assembly .....	1 pc.
• Burette (with 25-mL syringe)	
• Aspiration Tube with Fitting and Protection Tube	
• Dispensing Tube with Normal Dispensing Tip, Fitting, Protection Tube and Tube Guide	
• Tube Locks	
• Tool for Burette Cap Removal	
• Light Spectrum Protection Screen	
4 Stirrer Assembly.....	1 pc.
• Overhead Stirrer	
• Propeller (3 pcs.)	
• Stirrer Stand	
• Stirrer support with positioning collar and positioning screw	
5 Burette Blank Support .....	1 pc.
6 Pump and Burette Locking Screws with Plastic Head .....	2 pcs.
7 Temperature Sensor .....	1 pc.
8 Shorting Cap .....	1 pc.
9 Power adapter .....	1 pc.
10 Instruction Manual Binder .....	1 pc.
11 USB Memory Stick .....	1 pc.
12 Quality Certificate .....	1 pc.

See **Appendix 2**, *Titration components* section for pictures.

If any of the items are missing or damaged, please contact your sales representative.

**Note:** *Save all packing materials until you are sure that the instrument functions correctly. Any damaged or defective items must be returned in their original packing materials together with the supplied accessories.*

### 2.2 Safety Measures

The following safety measures must be followed:

1. Never connect or disconnect the pump assembly with the Titrator turned on.
2. Verify that the burette and the attached tubing are assembled correctly (see **Maintenance, Peripherals, Burette Maintenance** section for more details).
3. Always check that the titrant bottle and the titration beaker are on a flat surface.
4. Always wipe up spills and splashes immediately.
5. Avoid the following environmental working conditions:
  - Severe vibrations
  - Direct sunlight
  - Atmospheric relative humidity above 95% non-condensing
  - Environment temperatures below 10°C and above 40°C
  - Explosion hazards
6. Have the Titrator serviced only by qualified service personnel.

## 2.3 Installation

### 2.3.1 Titrator Front View

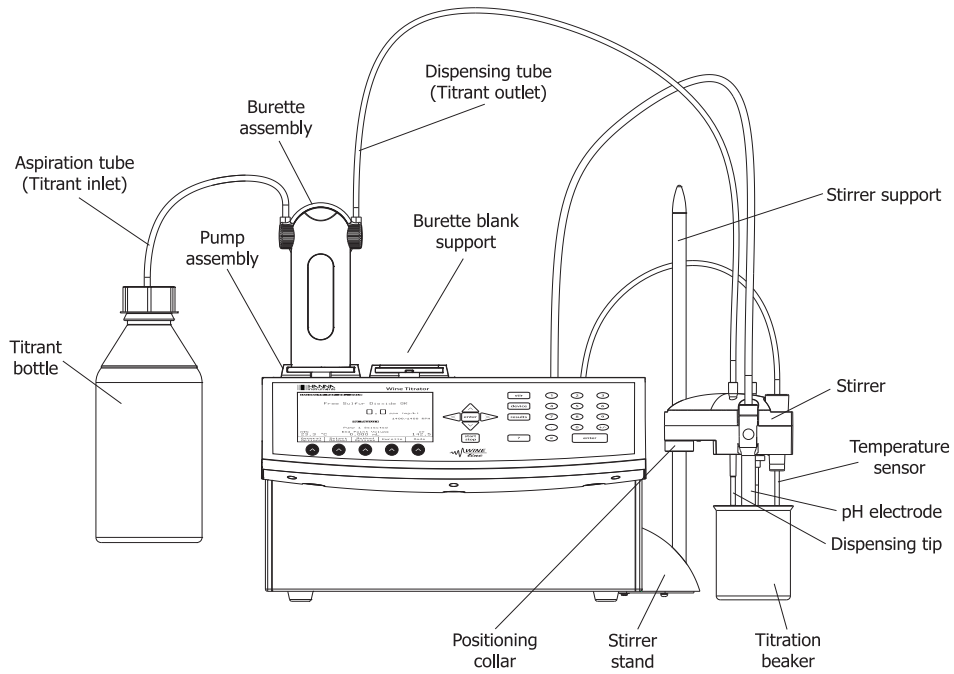

### 2.3.2 Titrator Rear View

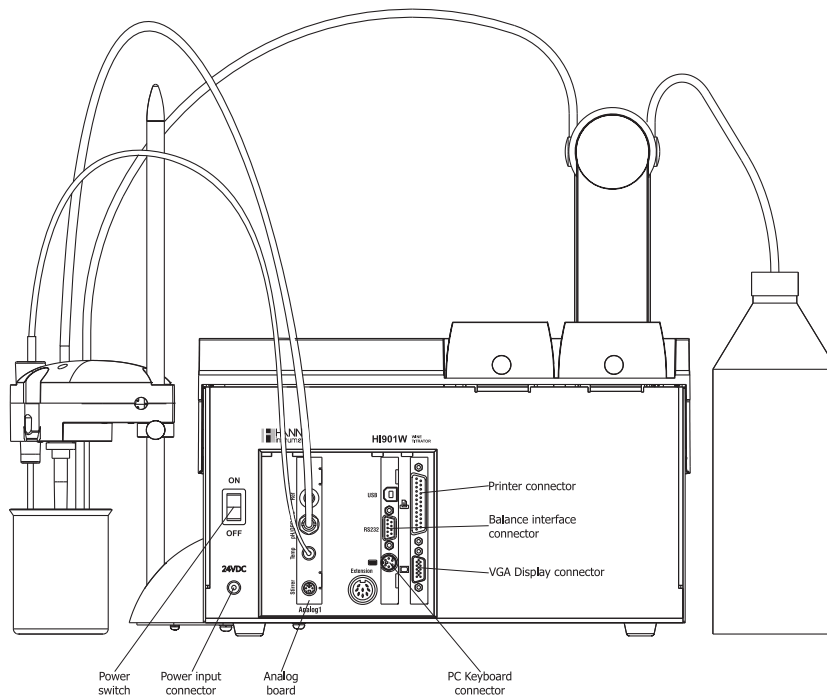

# SETUP

## 2.3.3 Titrator Left-side View

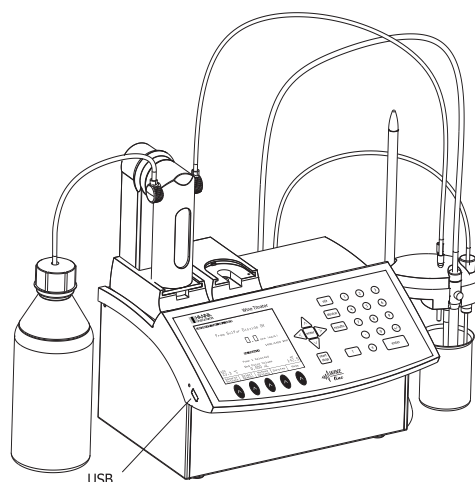

## 2.3.4 Titrator Assembly

**Note:** Assembly operations must be completed before connecting the Titrator to the power supply!

### 2.3.4.1 Assembling Stirrer Stand and Support

To assemble the stirrer stand and support:

- Remove the screws (B) from the Titrator base (A).
- Attach the stirrer stand (C) to the Titrator.
- Tighten the stirrer stand (C) using the previously removed screws (B).

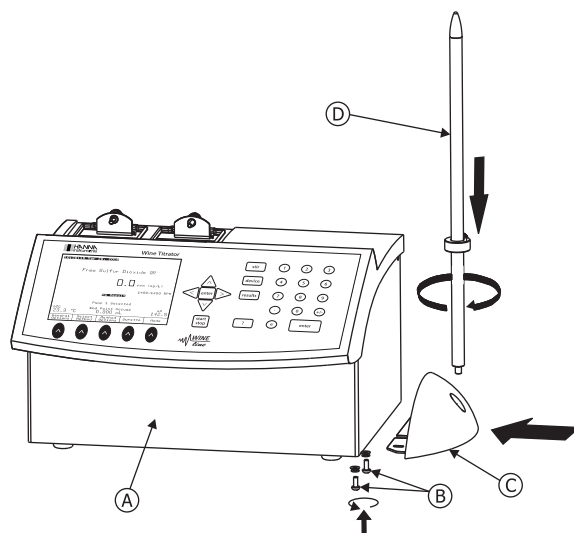

- Screw the stirrer support (D) in the stirrer stand (C).

### 2.3.4.2 Attaching Stirrer

To attach the stirrer to the Titrator, follow these steps:

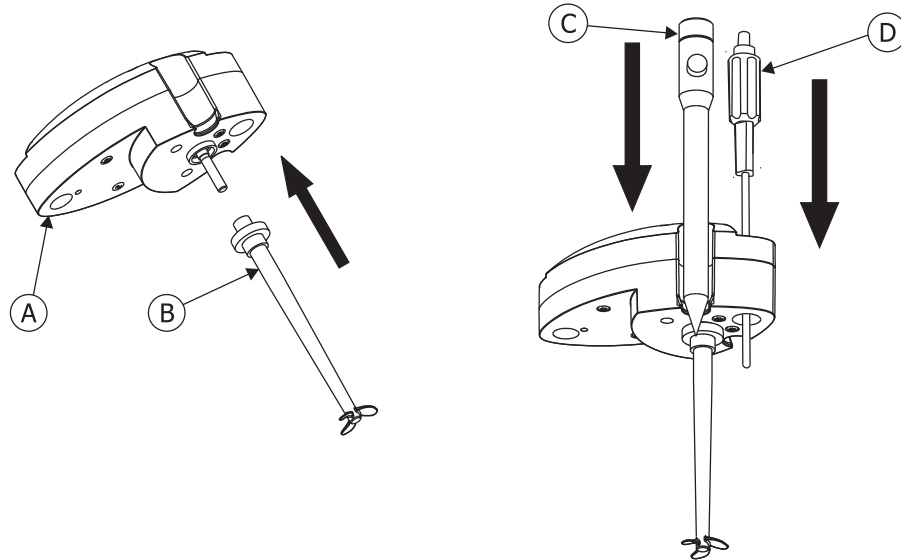

- Attach the propeller (B) to the stirrer (A) by pressing it onto the stirrer shaft.
- Insert the electrode (C) and temperature sensor (D) into the dedicated holes on the stirrer. Push them in until they are in a stable position.

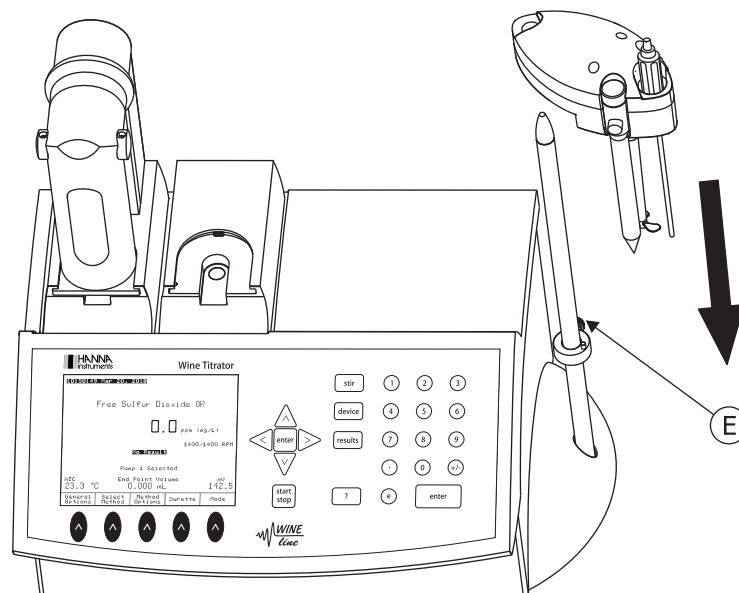

- Slide the stirrer on the stirrer support and set the height by tightening the screw located on the positioning collar (E).

## SETUP

### 2.3.4.3 Connecting the Pump

To connect the pump, follow these steps:

- Retrieve the pump cable from inside the bay. The pump 1 connector is located in the left bay.
- Connect the cable (A) to the pump as shown below. The pump connector (B) is located in the lower part of the pump, near the motor.
- Lower the pump into the Titrator, then slide it towards the front of the Titrator chassis (C) until it is firmly latched.
- Secure the pump with the locking screw (D).

This procedure can be repeated to connect a second pump.

Figure 1

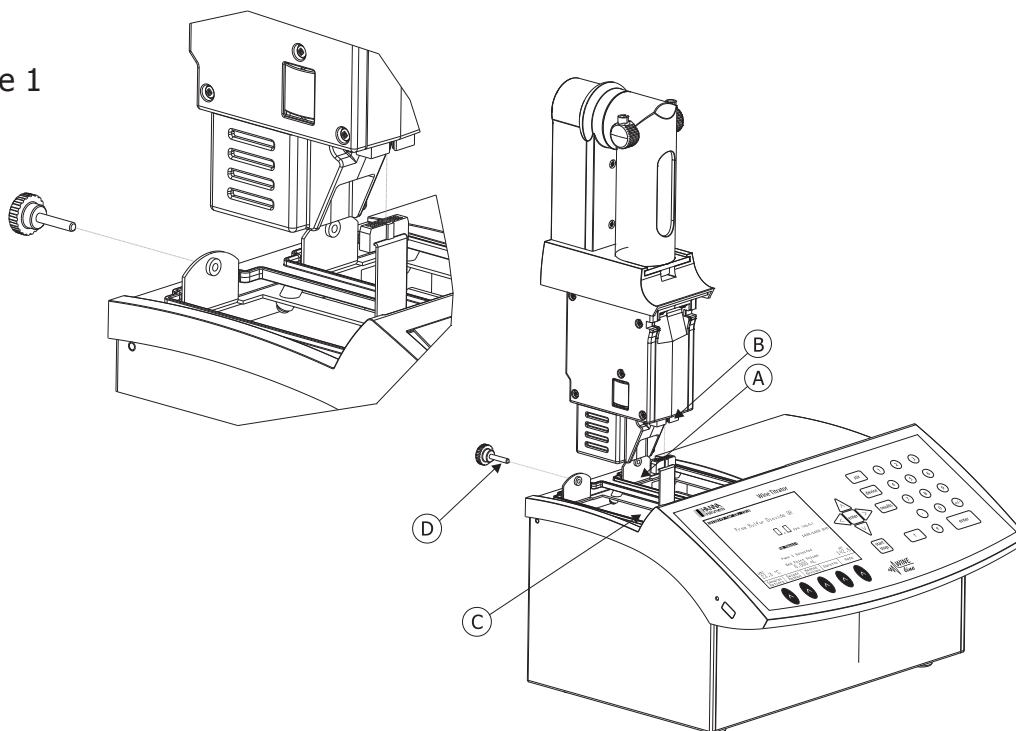



### 2.3.4.4 Attaching Burette Blank Support

To attach the burette blank support, follow these steps:

- Insert burette blank support into the bay. Lower the burette blank support into the Titrator, then slide it towards the front of the Titrator chassis until it is firmly latched.
- Secure the burette blank support with the locking screw.

### 2.3.4.5 Attaching Burette

Make sure that the mark from the valve actuating cap and from the burette body are aligned as shown in Figure 2.

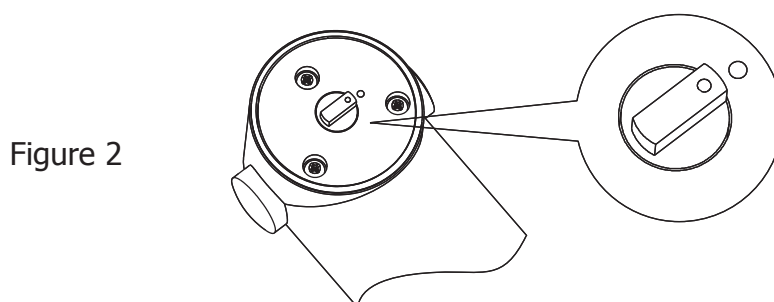

Figure 2

While ensuring the correct coupling between the syringe plunger (1) and the pump piston (2) (Figure 3), slide the burette into the support on the burette pump (Figure 4).

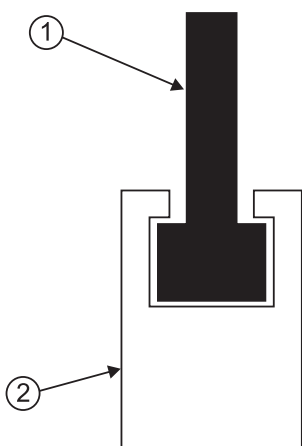

Figure 3

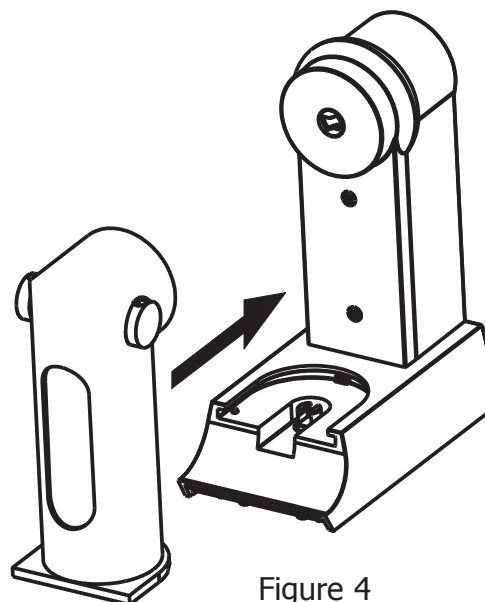
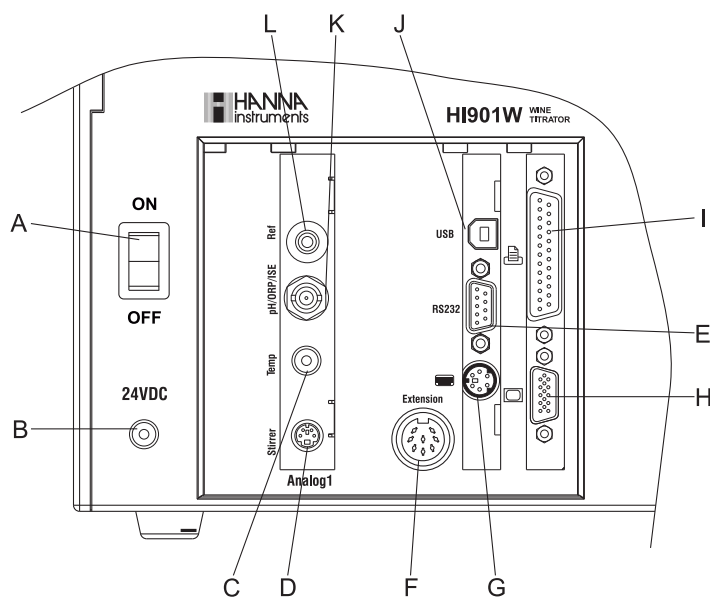

Figure 4

# SETUP

## 2.3.4.6 Electrical Connections

- Connect the electrode to the BNC connector (K).
- Connect the temperature sensor to the RCA connector (C).
- Connect the stirrer to the MINI-DIN connector (D).
- Connect the power adapter cable to the power input connector (B).



Nr	Function	Type of Connector
A	Power switch	
B	Power input connector (24VDC)	DC Power jack connector
C	Temperature sensor	RCA Socket
D	Stirrer	4-pin Mini DIN
E	RS232 interface (Balance Interface)	Standard DB 9 Pin Socket
F	Connector for expansion device (Reserved)	8-pin DIN
G	External PC keyboard	6-pin Mini DIN (Standard PS2)
H	External display	Standard VGA Display 15-pin Socket
I	Printer	DB 25-pin Socket
J	USB interface (Reserved)	USB Standard B
K	Connection for pH, ORP and ISE half-cell or combination electrodes	BNC Socket
L	Reference electrode	Ø 4 mm Banana Socket

**Chapter 3. Contents**

- 3 USER INTERFACE ..... 3 - 3**
- 3.1 Start Up ..... 3 - 3**
- 3.2 Description ..... 3 - 4**
  - 3.2.1 Keypad ..... 3 - 4
    - 3.2.1.1 Function Keys ..... 3 - 4
    - 3.2.1.2 Option Keys ..... 3 - 4
    - 3.2.1.3 Arrow Keys ..... 3 - 5
    - 3.2.1.4 Numeric Keys ..... 3 - 5
    - 3.2.1.5 Enter Key ..... 3 - 5
  - 3.2.2 Display ..... 3 - 5
  - 3.2.3 The Main Screen ..... 3 - 6
- 3.3 Menu Navigation ..... 3 - 7**
  - 3.3.1 Selecting an Option ..... 3 - 7
  - 3.3.2 Selecting a Menu Item ..... 3 - 7
  - 3.3.3 Entering Text ..... 3 - 7
  - 3.3.4 Saving Modifications ..... 3 - 8



---

**3 USER INTERFACE****3.1 Start Up**

Once the instrument is assembled and installed, follow the steps below to start the Titrator:

- Connect the instrument to a power outlet with the supplied power adapter.
- Turn on the Titrator from the power switch located on the back of the instrument.
- Wait until the Titrator finishes the initialization process.
- Press  when prompted or wait a few seconds for Titrator to start.

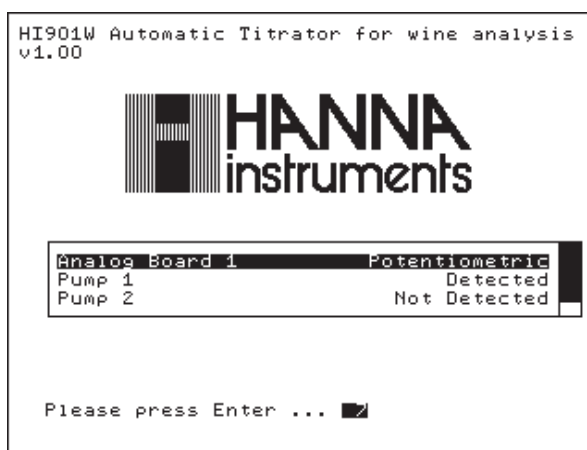

**Note:** All the performed initialization processes must be successfully completed. If one of them is terminated by a "Failed" message, restart the Titrator from the power switch. If the problem persists, contact your dealer.

# USER INTERFACE

## 3.2 Description

This chapter describes the basic principles of navigating through the user interface, selecting fields and entering values from the keypad.

### 3.2.1 Keypad

The titrator's keypad is grouped into five categories, as follows:

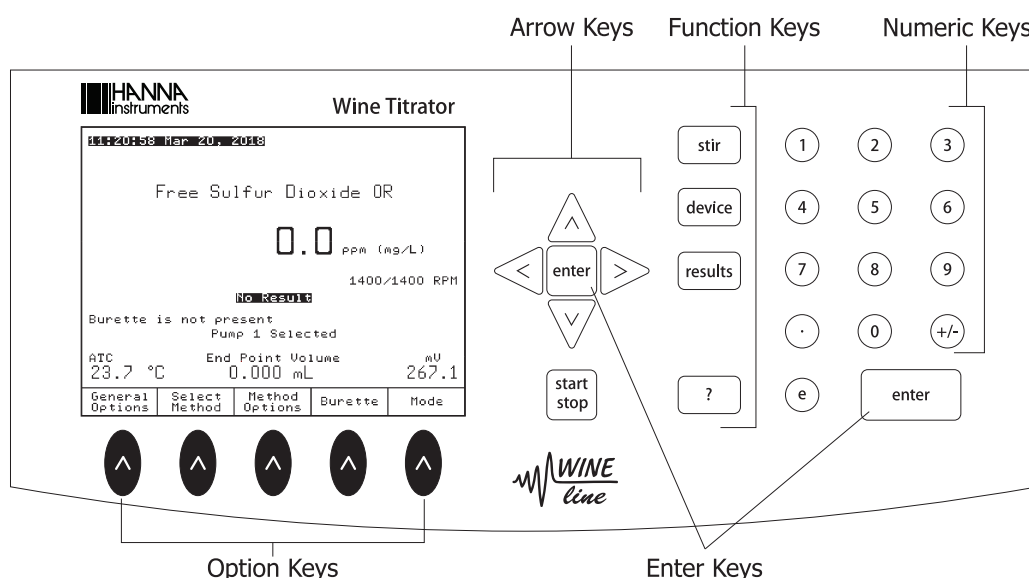

#### 3.2.1.1 Function Keys

If one of these keys is pressed, the associated function is immediately performed. Some of the keys are active only in specific screens:

	Starts or stops a titration
	Turns the selected stirrer ON and OFF
	Reserved
	Access the results menu
	Displays contextual Help

#### 3.2.1.2 Option Keys

These keys are assigned to the virtual keys on the display. Their functions are listed in the boxes above the buttons and vary depending on the displayed screen.

An underlined virtual key can also be activated by pressing .

### 3.2.1.3 Arrow Keys

These keys have the following functions:

- Move the on-screen cursor.
- Increase and decrease the stirrer speed and other settings.
- In the alphanumeric screen, to select a character.
- Navigate through menu options.

### 3.2.1.4 Numeric Keys

- Keys 0 to 9 Used for numeric entries.
- +/- Toggles between positive and negative values.
- . Decimal point.
- e Initiates entry of exponent for scientific notation.

### 3.2.1.5 Enter Key

Both ,  keys perform the same functions:

- Accept alphanumeric data entry.
- Executes the default (underlined) virtual option key.

## 3.2.2 Display

The Titrator has a large color graphical display. The main screen is shown below with short explanations of the screen segments.

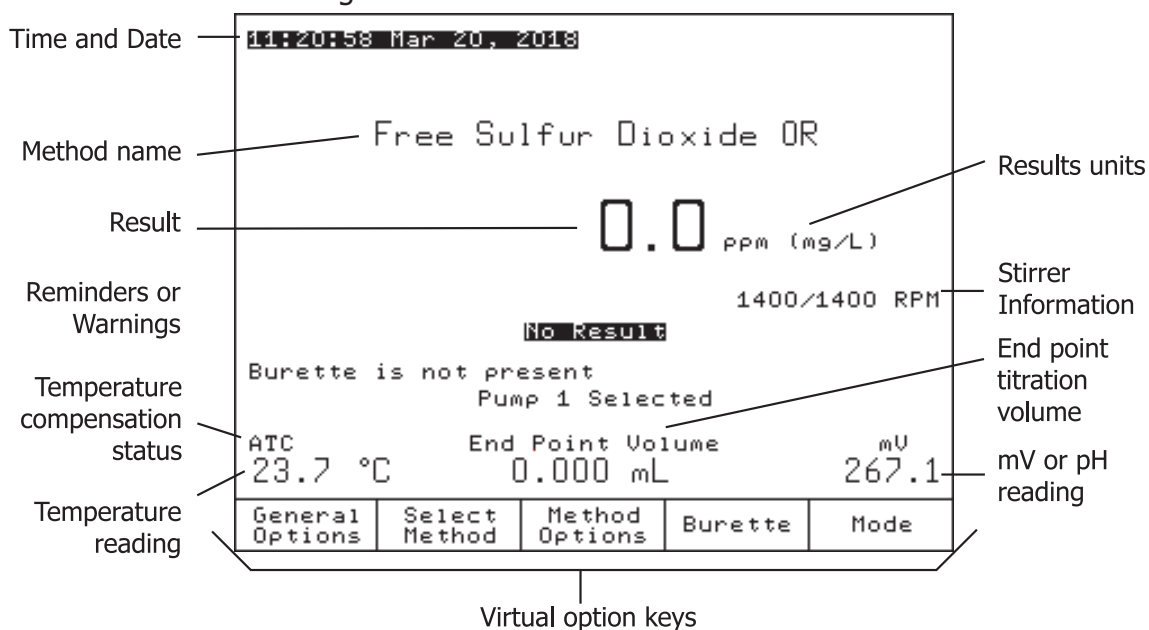

## USER INTERFACE

---

The user interface contains several screens. For each titrator function, one or more screens are used.

### 3.2.3 The Main Screen

After start up and initialization, the first screen displayed is the main screen.

Main screen fields:

<b>Method name:</b>	Displays the name of the selected method.
<b>Time and date:</b>	Displays the current date and time.
<b>Temperature reading:</b>	Displays the measured temperature.
<b>ATC:</b>	Automatic temperature compensation
<b>Manual:</b>	Manual temperature compensation
<b>Manual:</b>	Temperature probe is not connected, manual temperature compensation
<b>Stirrer information:</b>	Actual / Set stirrer speed is displayed in RPM. When stirrer is off, the stirrer information is not displayed.
<b>End point volume:</b>	Displays the volume delivered to reach the titration end point. When no titration has been performed, the displayed volume is "0.000 mL".
<b>Result:</b>	Displays the titration result or the direct reading measurement.
<b>mV or pH reading:</b>	Displays the current readings. The reading will be in mV or pH.
<b>mV:</b>	Indicates actual potential reading.
<b>rel mV:</b>	Indicates relative potential reading.
<b>pH:</b>	Indicates actual pH value.
<b>Titration status:</b>	Displays the status of the selected titration. <b>No results</b> is displayed when a titration has not been performed.
<b>Reminders:</b>	Indicates when a task needs to be performed and displays error or warning messages.
<b>Pump 1 Selected:</b>	Displays the active pump.



## 3.3 Menu navigation

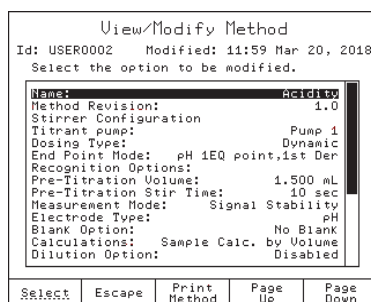
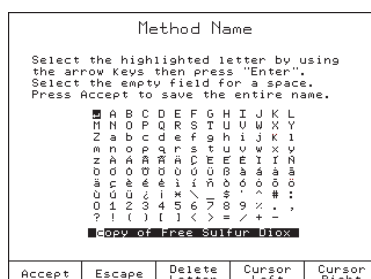
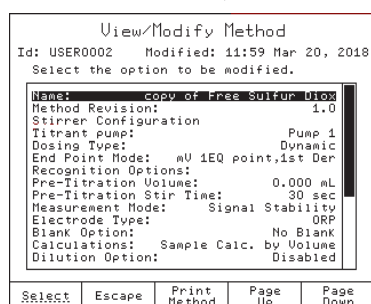
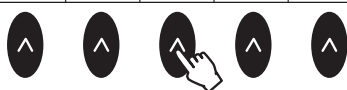
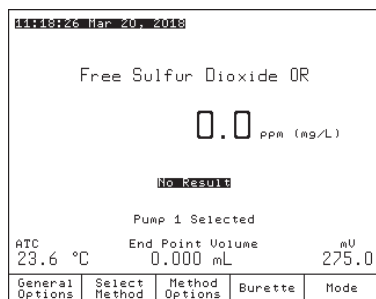





### 3.3.1 Selecting an Option

To select an option, simply press the option key below the virtual key. For example, to access the **Method Options** screen press the option key below it.

### 3.3.2 Selecting a Menu Item

To select an item from the menu screen, use the arrow keys  $\triangle$  and  $\nabla$  to move the cursor.



When the menu is larger than the display, a scroll bar is active on the right side. The  and  keys can be used to scroll through the pages.

To activate the selected menu item, press  or .

### 3.3.3 Entering Text

To enter text in an alphanumeric input box, first erase the previous text by using .

To enter a letter, highlight it using the arrow keys then press . Use the same procedure to enter the whole name.

For editing, use the  and  keys.

When editing is complete, press .

The method name will be updated and displayed in the name field of the **View/Modify Method** screen.

When all the desired parameters have been set, press .

# USER INTERFACE

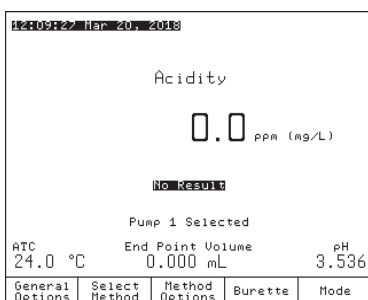
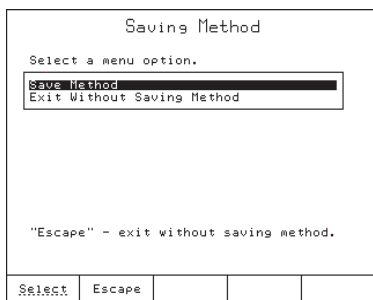

## 3.3.4 Saving Modifications

The **Saving Method** screen allows the user to save the modifications. To exit from **Saving Method** screen without saving, press **Escape** or highlight the **Exit Without Saving Method** option and then press **Select**. To save the modifications highlight the **Save Method** option and then press **Select**.

After the method name is changed, it appears in the method name field.

**Note:** To access the contextual help menu, press **?** at any time. Help is related to the displayed screen. Press **Escape** or press **?** again to return to the previous screen.

## **Chapter 4. Contents**

<b>4</b>	<b>GENERAL OPTIONS .....</b>	<b>4 -3</b>
<b>4.1</b>	<b>Save Files to USB Storage Device .....</b>	<b>4 -3</b>
<b>4.2</b>	<b>Restore Files from USB Storage Device .....</b>	<b>4 -4</b>
<b>4.3</b>	<b>Administration .....</b>	<b>4 -5</b>
<b>4.4</b>	<b>Temperature .....</b>	<b>4 -6</b>
4.4.1	Temperature Source .....	4 -7
4.4.2	Manual Temperature Setting .....	4 -7
4.4.3	Temperature Units .....	4 -8
<b>4.5</b>	<b>Date and Time Setting .....</b>	<b>4 -8</b>
<b>4.6</b>	<b>Display Settings .....</b>	<b>4 -9</b>
<b>4.7</b>	<b>Beeper .....</b>	<b>4 -10</b>
<b>4.8</b>	<b>Stirrer .....</b>	<b>4 -10</b>
<b>4.9</b>	<b>Language .....</b>	<b>4 -11</b>
<b>4.10</b>	<b>Total Volume Alert .....</b>	<b>4 -11</b>
<b>4.11</b>	<b>Titrant Age Reminder .....</b>	<b>4 -12</b>
<b>4.12</b>	<b>Setup Balance Interface .....</b>	<b>4 -13</b>
<b>4.13</b>	<b>Printer Mode .....</b>	<b>4 -14</b>
<b>4.14</b>	<b>Reset to Default Settings .....</b>	<b>4 -14</b>
<b>4.15</b>	<b>Optimize Memory Space .....</b>	<b>4 -15</b>
<b>4.16</b>	<b>Update Software .....</b>	<b>4 -15</b>



## 4 GENERAL OPTIONS

The **General Options** screen gives access to options that are not directly related to the titration process or pH / mV / ISE measurement. To access this screen, press  from the main screen.

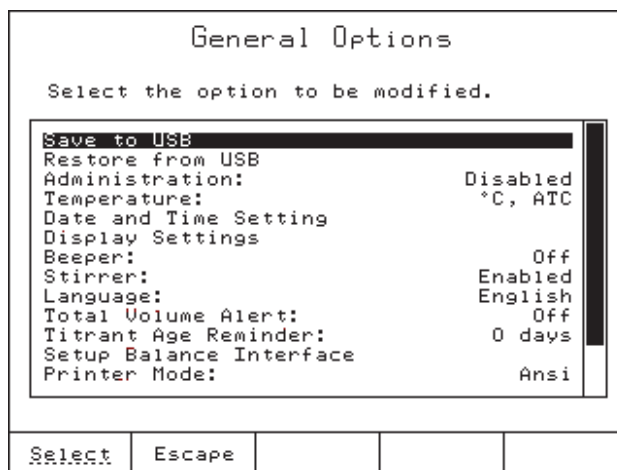

The available menus are described below:



### 4.1 Save Files to USB Storage Device

This option allows the user to save files from the Titrator to a USB storage device. On the Titrator, the available file types are:



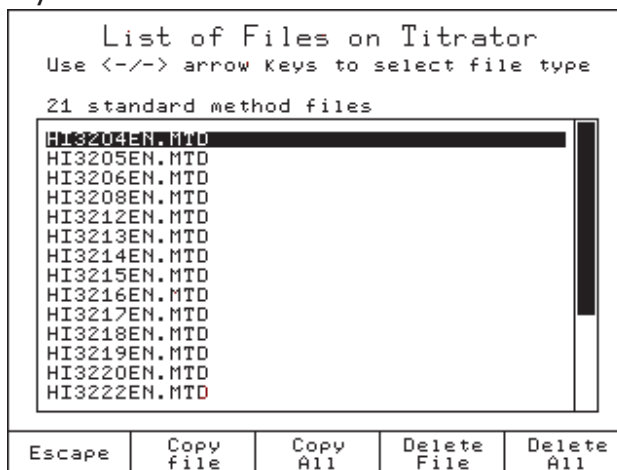

- Standard Method Files - **HI3204EN.MTD** or **HI3205EN.MTD**
- User Method Files - **USERXXXX.MTD** (e.g.: USER0001.MTD)
- Report Files - **Ti\_XXXXX.RPT, mV\_XXXXX.RPT, pH\_XXXXX.RPT, ISEXXXXX.RPT, mVrXXXXX.RPT** (e.g.: Ti\_00001.RPT, mV\_00001.RPT, pH\_00001.RPT, ISE00001.RPT, mVr00001.RPT)

Use the  and  keys to select the file type. The number of files and each file name on the Titrator will be displayed.



# GENERAL OPTIONS

The option keys allow the following operations:

-  Deletes the highlighted file.
-  Deletes all currently displayed files.
-  Copies the highlighted file from Titrator to a USB storage device.
-  Copies all currently displayed files from Titrator to a USB storage device.
-  Returns to the **General Options** screen.

The status of the transfer ("Successful" / "Unsuccessful") and the file name of the currently processed file are displayed during copying or deleting.

**Note:** The saved files will be stored on the USB key in the **HI901W** folder, as follows:

- Methods: **USB Drive: \HI901W\Methods\\*.mtd**
- Reports: **USB Drive: \HI901W\Reports\\*.rpt**

## 4.2 Restore Files from USB Storage Device

This screen allows the user to transfer files from the USB storage device to the Titrator.

The file types that can be transferred are:

- Standard Method Files - **HI3204EN.MTD** or **HI3205EN.MTD**
- User Method Files - **USERXXXX.MTD** (e.g.: USER0001.MTD)
- Report Files - **Ti\_XXXXX.RPT, mV\_XXXXX.RPT, pH\_XXXXX.RPT, ISEXXXXX.RPT, mVrXXXXX.RPT** (e.g.: Ti\_00001.RPT, mV\_00001.RPT, pH\_00001.RPT, ISE00001.RPT, mVr00001.RPT)

Use the ◀ and ▶ keys to select the file type.

The number of files and the name of each file found on the USB storage device is displayed on the screen.

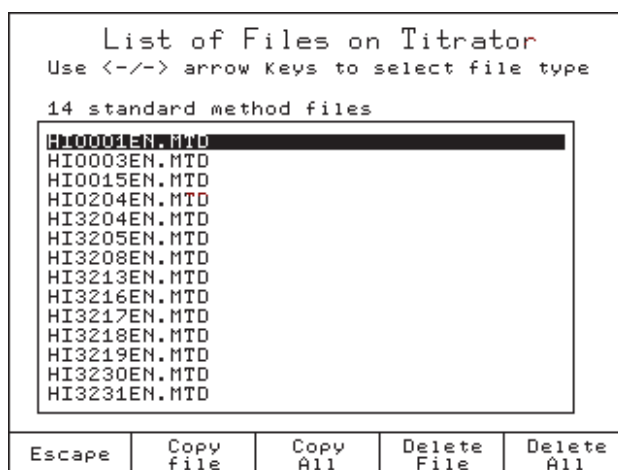

The option keys allow the following operations:

- Delete File Deletes the highlighted file from the USB storage device.
- Delete All Deletes all currently displayed files from the USB storage device.
- Copy File Copies the highlighted file from the USB storage device to the Titrator.
- Copy All Copies all currently displayed files from the USB storage device to the Titrator.
- Escape Returns to the **General Options** screen.

**Note:** In order to restore files from a USB key, please ensure that the methods and / or reports you wish to transfer to the Titrator are in the correct folder:

- Methods: **USB Drive: |HI901W|Methods|\*.mtd**
- Reports: **USB Drive: |HI901W|Reports|\*.rpt**

### 4.3 Administration

A 4-digit numeric PIN can be set to prevent unauthorized changes from being made. When the user enters administration and a pin has not been set, the user will be prompted to enter a new PIN.

Titrator Administration

Administrator PIN has not been set.  
Enter a 4-digit PIN to enable Administrator function.

Enter PIN: ----

Confirm PIN: ----

Your PIN must be 4-digits long.

Next	Escape	Delete Digit	
------	--------	--------------	--

Once a PIN has been set, the Titrator can be locked. When a Titrator is locked, the users cannot modify methods or delete reports. Basic functions are still available (review reports, save to USB, etc.).

Titrator Administration

Titrator is UNLOCKED.

Lock Titrator

Enter PIN: ----

Accept	Escape	Delete Digit	
--------	--------	--------------	--

## GENERAL OPTIONS

---

To return to administrator mode, the Titrator can be unlocked by entering the PIN.

Titration Administration				
Titration is LOCKED.				
Unlock Titration	Escape			Recovery PIN

If the PIN is lost or forgotten, press recovery pin and contact technical support to supply the required information.

Recovery PIN				
For recovery PIN, please contact your vendor. When requesting PIN please provide following information:				
Titration Serial Number: 12133404				
Code: 0019				
Recovery PIN: [REDACTED]				
Accept	Escape	Delete Digit		

### 4.4 Temperature

The **Temperature Menu** allows access to all of the settings related to temperature.

Temperature Menu							
Select temperature option to be modified.							
<table border="1"><tr><td>Temperature Source</td></tr><tr><td>Manual Temperature Setting</td></tr><tr><td>Temperature Units</td></tr></table>					Temperature Source	Manual Temperature Setting	Temperature Units
Temperature Source							
Manual Temperature Setting							
Temperature Units							
Select	Escape						



## 4.4.1 Temperature Source

Select the temperature source used for temperature compensation.

Temperature Menu																			
Select temperature option to be modified.																			
<table border="1"> <tr> <td>Temperature Source</td> <td colspan="4">Automatic Temperature</td> </tr> <tr> <td>Manual Temperature</td> <td colspan="4">Manual Temperature</td> </tr> <tr> <td>Temperature Units</td> <td colspan="4"></td> </tr> </table>					Temperature Source	Automatic Temperature				Manual Temperature	Manual Temperature				Temperature Units				
Temperature Source	Automatic Temperature																		
Manual Temperature	Manual Temperature																		
Temperature Units																			
Select	Escape																		

When *Automatic Temperature Compensation* is selected, "ATC" is displayed on the main screen and the temperature is read by the temperature probe.

When *Manual Temperature* is selected, "Manual" is displayed on the main screen and a preset temperature value is used for temperature compensation.

**Note:** The selected temperature source will be indicated in the report files: A for Automatic and M for Manual.

## 4.4.2 Manual Temperature Setting

If the temperature probe is not connected, the user can manually set the temperature used by the Titrator for compensation. This can be done when the *Manual Temperature* option is selected.

The temperature value can be set between -5 and 105 °C.

Manual Temperature				
Enter the manual temperature to be used when the temperature probe is being overridden or no temperature probe.				
<div style="border: 1px solid black; display: inline-block; padding: 2px;">25.0 °C</div>				
The temperature range is from -5.0 to 105.0°C.				
Accept	Escape	Delete Digit		

## GENERAL OPTIONS

### 4.4.3 Temperature Units

The following temperature units can be selected.

```
Temperature Menu

Select temperature option to be modified.

Temperature Source
Manual Temperature Setting
Temperature Units

Celsius      -5.0 to 105.0 °C
Fahrenheit   23.0 to 221.0 °F
Kelvin       268.2 to 378.2 K

Select  Escape
```

The temperature ranges are as displayed in the **Temperature Units** screen.

### 4.5 Date and Time Setting

This screen allows the user to set the date and time.

```
Date and Time Setting

Enter the date.

  3      21      2018
 month   day     year

Enter the time.

  10      0      23
 hour    minute  second

Press Next to move to the next entry.

Accept  Escape  Delete Digit  Next  AM/PM
```

Use the  and  keys or the numeric keys to modify the date and time.

Press  to move the cursor to the next field.

Press  or  to change the time format.

### 4.6 Display Settings

This screen allows the user to customize the display settings.

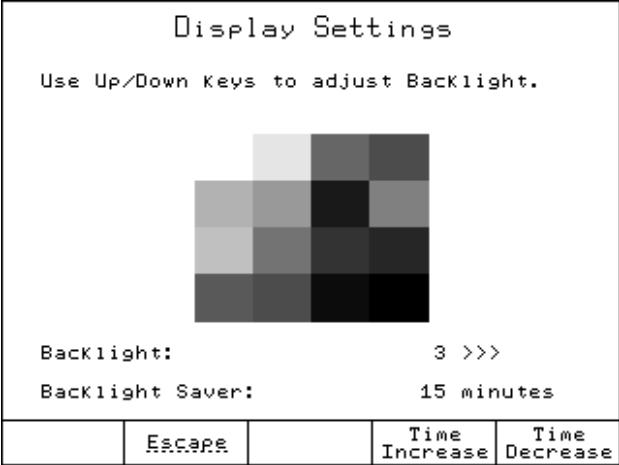

Option Keys:

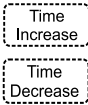

- Increases the backlight saver time interval
- Decreases the backlight saver time interval

The backlight intensity can be adjusted using  $\triangle$  and  $\nabla$  keys.

There are 8 levels of backlight intensity, ranging from 0 to 7.

A color palette is displayed in the center of the screen allowing an easy selection of the appropriate backlight intensity.

The backlight saver option protects the display during standby periods when no keys have been pressed for a set amount of time.

If the display backlight is off, any keystroke will activate the backlight without performing any action.

The range for the backlight saver timer is 1 to 60 minutes. To disable the backlight saver, increase the time to the maximum allowed. The "Off" indication will appear.

# GENERAL OPTIONS

## 4.7 Beeper

This screen allows the user to be turn the Beeper On (enabled) or Off (disabled).

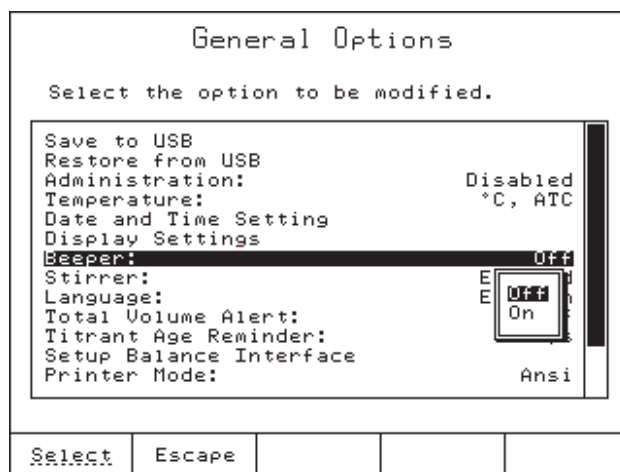

The beeper will sound after a titration is completed, when an invalid key is pressed or when a critical error occurs during titration.

## 4.8 Stirrer

This screen allows the stirrer to be enabled or disabled.

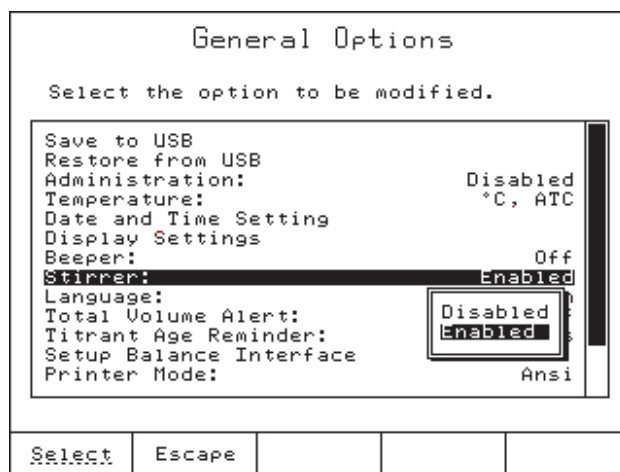

## 4.9 Language

Select an available language.

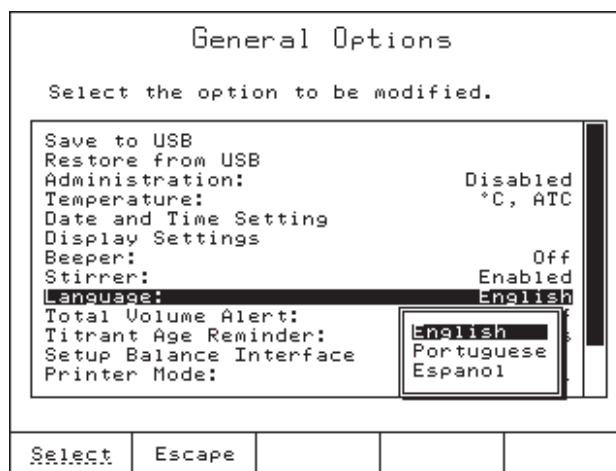

## 4.10 Total Volume Alert

This screen allows a programmable reminder to appear when the titrant reservoir is below 100 mL. The titrant volume will decrease as the titrant is used.

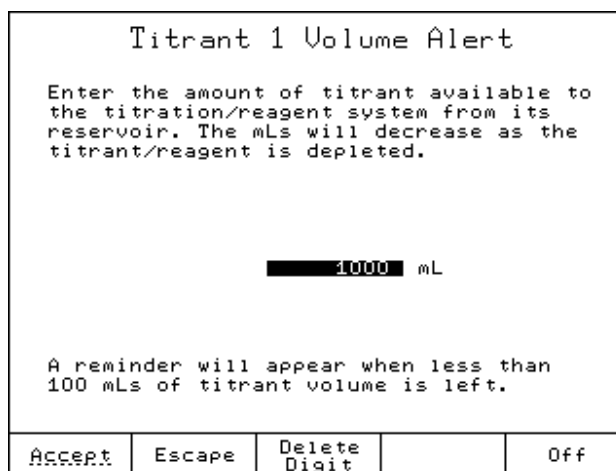

The "Low Titrant Volume" reminder message will appear when the available titrant volume is under 100 mL.

After the new titrant volume has been set on the Titrator (in the **Total Volume Alert** screen), a warning message appears reminding the user to perform titrant re-standardization. The volume of titrant can be set from 0 to 10,000 mL.

## GENERAL OPTIONS

---

### 4.11 Titrant Age Reminder

A programmable reminder will appear when it is time to verify the titrant concentration or to change the titrant.

Titrant Age Reminder				
Enter the number of days to pass since the last Titr. Vol. updating or the last Start pressing, whereafter the reminder appears.				
██████████ 30 days				
The range is from 0 to 31 days.				
Start	Escape	Delete Digit		Off

The "Check Titrant Concentration" reminder will appear when the set number of days has passed since the total volume alert was set or since the timer was started. The reminder can be disabled by pressing .

The range is from 0 to 31 days.

## 4.12 Setup Balance Interface

This screen allows the users to connect an analytical balance for automatic acquisition of sample mass prior to titration or standardization.

Setup Balance Interface

Select the balance to be activated.

\* Lab balance

Disable Balance	Escape	New Balance	Edit
-----------------	--------	-------------	------

The balance is connected to the Titrator via RS 232 interface.

Press New Balance to add a new balance to the list.

Press Enable Balance to enable the balance interface feature.

Press Disable Balance to disable the balance feature (automatic weight acquisition will be not available).

Press Edit to customize the serial communication parameters by accessing the **Balance Configuration** screen.

Balance Configuration

Select the option to be modified.

Balance Name	Lab Balance
Baud Rate	9600
Data Bits	8 Bits
Parity	No Parity
Stop Bit	1 bit
Edit Request Command	B

Select	Escape	Test Balance
--------	--------	--------------

Be sure that the settings on the Titrator *Balance Configuration* menu match the settings for your particular balance (baud rate, data bits, parity, stop bits number, request command syntax). It may be necessary to change settings on your balance. Users should consult their balance instruction manual.

Before leaving this screen, be sure the connection with the balance is working properly by pressing the Test Balance key.

## GENERAL OPTIONS

### 4.13 Printer Mode

This screen allows the users to select the printing mode: Ansi (default), Ascii and Text mode.

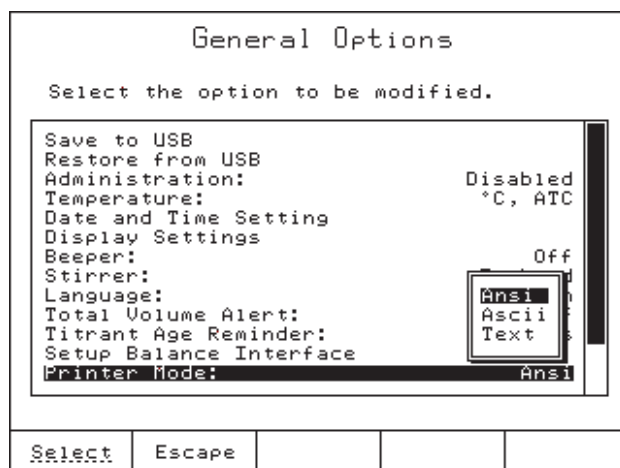

#### **Ansi mode:**

Use this mode when your printer is set as Ansi. In this case all the accented characters / symbols available in Titrator will be printed on your printer.

#### **Ascii mode:**

Use this mode when your printer is set as Ascii. In this case only some of the accented characters / symbols available in Titrator will be printed on your printer.

#### **Text mode:**

Use this mode when you don't need to print the accented characters.

### 4.14 Reset to Default Settings

This option restores the manufacturer settings.

**Note:** This will also delete all the user - created methods and restore all manufacturer settings such as titrator configuration, standard method parameters, etc.

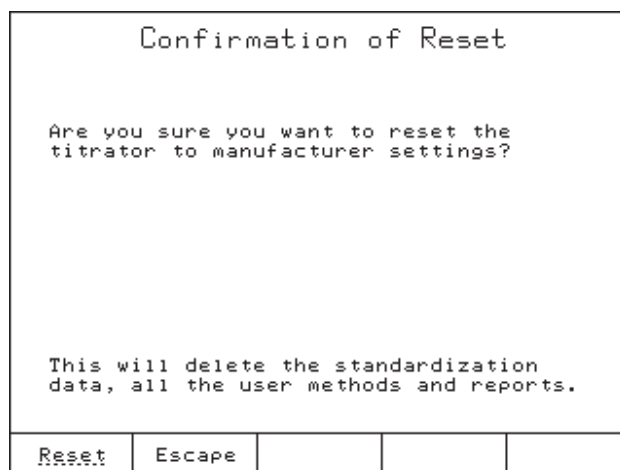



## 4.15 Optimize Memory Space

This screen allows the user to optimize the memory.

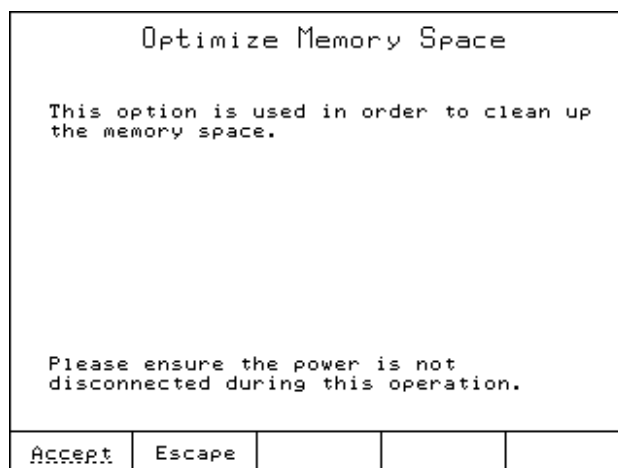

## 4.16 Update Software

This screen allows the user to update the titrator software from a USB storage device containing a software setup kit.

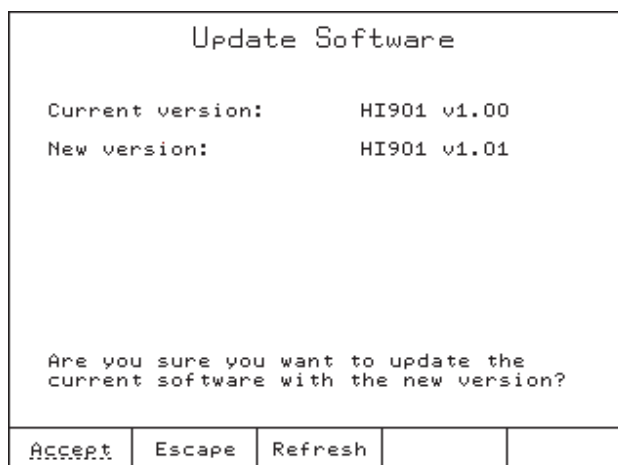

To update the software:

- Copy the "SET901W" folder to a USB storage device.
- Insert the USB storage device into the Titrator.
- Go to "General Options", then "Update Software". The Titrator should display the current and new software versions.
- Press . When prompted, remove the USB storage and restart the Titrator.



**Chapter 5. Contents**

<b>5</b>	<b>TITRATION METHODS</b> .....	<b>5 - 3</b>
<b>5.1</b>	<b>Selecting Methods</b> .....	<b>5 - 3</b>
<b>5.2</b>	<b>Standard Methods</b> .....	<b>5 - 4</b>
5.2.1	Upgrading Standard Methods .....	5 - 4
5.2.2	Deleting Standard Methods.....	5 - 4
5.2.3	Restore the Standard Methods to the Manufacturer Settings .....	5 - 5
<b>5.3</b>	<b>User Methods</b> .....	<b>5 - 5</b>
5.3.1	Creating User Methods.....	5 - 5
5.3.2	Deleting User Methods .....	5 - 6
<b>5.4</b>	<b>View / Modify Method</b> .....	<b>5 - 6</b>
<b>5.5</b>	<b>Method Options</b> .....	<b>5 - 7</b>
5.5.1	Name .....	5 - 7
5.5.2	Method Revision .....	5 - 8
5.5.3	Stirrer Configuration .....	5 - 9
5.5.4	Pump Configuration .....	5 - 9
5.5.5	Dosing Type .....	5 - 10
5.5.5.1	Linear Dosing .....	5 - 10
5.5.5.2	Dynamic Dosing.....	5 - 11
5.5.6	End Point Mode .....	5 - 12
5.5.6.1	Fixed End Point (pH or mV) .....	5 - 13
5.5.6.2	Equivalence End Point (pH or mV).....	5 - 14
5.5.7	Recognition Options (Equivalence End Point only) .....	5 - 16
5.5.7.1	Threshold.....	5 - 17
5.5.7.2	Range.....	5 - 18
5.5.7.3	Filtered Derivatives .....	5 - 19
5.5.8	Pre-Titration Volume.....	5 - 19
5.5.9	Pre-Titration Stir Time .....	5 - 20
5.5.10	Measurement Mode .....	5 - 20

## TITRATION METHODS

---

5.5.10.1	Signal Stability .....	5 - 21
5.5.10.2	Timed Increment .....	5 - 23
5.5.11	Electrode Type .....	5 - 24
5.5.12	Blank Option .....	5 - 24
5.5.13	Calculations .....	5 - 25
5.5.13.1	Edit Variable Values .....	5 - 25
5.5.13.2	No Formula (mL only) .....	5 - 25
5.5.13.3	No Formula (L only) .....	5 - 25
5.5.13.4	Sample Calculation by Weight .....	5 - 26
5.5.13.5	Sample Calculation by Volume .....	5 - 27
5.5.13.6	Standardize Titrant by Weight .....	5 - 29
5.5.13.7	Standardize Titrant by Volume .....	5 - 29
5.5.13.8	Generic Formula .....	5 - 29
5.5.14	Dilution Option .....	5 - 32
5.5.15	Titrant Name .....	5 - 32
5.5.16	Titrant Concentration .....	5 - 33
5.5.17	Analyte Size .....	5 - 33
5.5.18	Analyte Entry .....	5 - 34
5.5.18.1	Fixed Weight or Volume .....	5 - 34
5.5.18.2	Manual Weight or Volume .....	5 - 34
5.5.19	Maximum Titrant Volume .....	5 - 34
5.5.20	Potential Range .....	5 - 35
5.5.21	Volume/Flow Rate .....	5 - 35
5.5.22	Signal Averaging .....	5 - 36
5.5.23	Significant Figures .....	5 - 36
<b>5.6</b>	<b>Printing .....</b>	<b>5 - 36</b>

## 5 TITRATION METHODS

All of the parameters required to complete an analysis are grouped into a method. The Titrator is supplied with a pack of standard methods. Standard and user methods can be upgraded, saved or deleted using a USB storage device.

### 5.1 Selecting Methods

To select a method, press Select Method from the main screen. A list of available methods will be displayed.

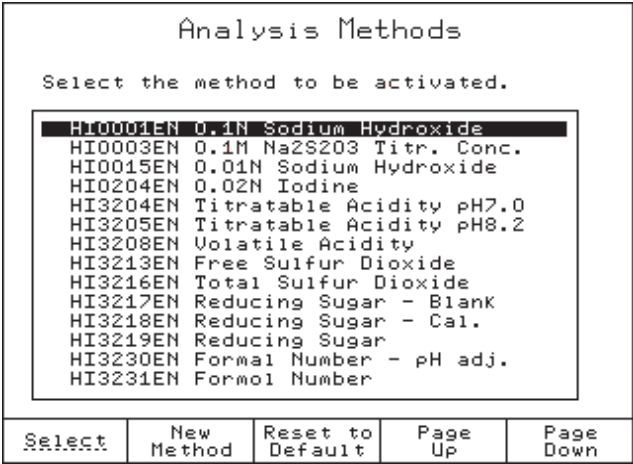

In the **Analysis Methods** screen, you can view the list of all available methods (standard and user methods).

To select a method, highlight the method then press Select. The name of the selected method will be displayed on the main screen.

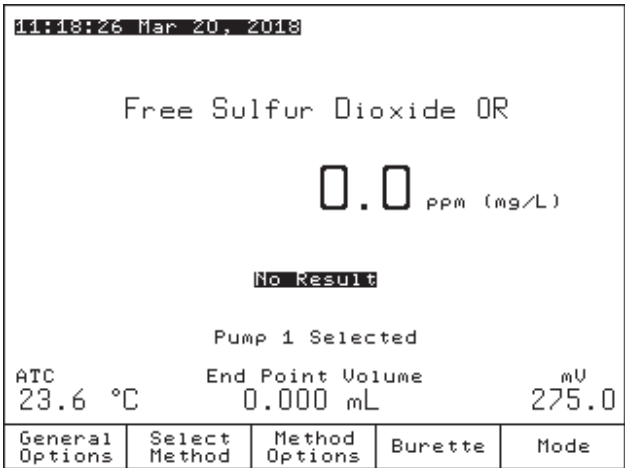

# TITRATION METHODS

---









## 5.2 Standard Methods

The standard methods are developed for the most common types of analysis. Only specific method parameters can be modified by the user (see *Method Options* section). Also, standard methods can be used as models to create new user methods.

### 5.2.1 Upgrading Standard Methods

To upgrade the Titrator with new standard methods, follow the steps below:









#### From USB Storage Device:

- Insert the USB storage device into the USB port, located on the left side of the Titrator.
- Press  from the main screen.
- Using  and  keys, highlight the *Restore Files from USB Storage Device* option and choose .
- Using  and  keys, navigate through file types to find "standard method files". The list with available standard methods will be displayed.
- Press the  or  key to upgrade the Titrator with the standard methods.
- Press  to return to **General Options** screen.

### 5.2.2 Deleting Standard Methods

Unnecessary standard methods can be removed from the Titrator by following the procedure below:

#### From General Options Screen:

- Using the  and  keys, highlight the *Save Files to USB Storage Device* option and press .
- Using the  and  keys, navigate through the file types menu to find "standard method files". The available standard methods will be displayed.
- Press the  or  keys to remove unnecessary standard methods.
- Press  to return to the **General Options** screen.

**Note:** Only a limited number of user methods can be generated. The Titrator can hold 100 methods (standard and user). When it is reached, a warning message will be displayed.

## 5.2.3 Restore the Standard Methods to the Manufacturer Settings

You can restore the standard methods to the manufacturer setting by highlighting a standard method and pressing .





<p style="text-align: center;">Analysis Methods</p> <p>Select the method to be activated.</p> <div style="border: 1px solid black; padding: 2px;"> <p><b>HI0001EN 0.1N Sodium Hydroxide</b></p> <p>HI0003EN 0.1M Na2S2O3 Titr. Conc.</p> <p>HI0015EN 0.01N Sodium Hydroxide</p> <p>HI0204EN 0.02N Iodine</p> <p>HI3204EN Titratable Acidity pH7.0</p> <p>HI3205EN Titratable Acidity pH8.2</p> <p>HI3208EN Volatile Acidity</p> <p>HI3213EN Free Sulfur Dioxide</p> <p>HI3216EN Total Sulfur Dioxide</p> <p>HI3217EN Reducing Sugar - Blank</p> <p>HI3218EN Reducing Sugar - Cal.</p> <p>HI3219EN Reducing Sugar</p> <p>HI3230EN Formal Number - pH adj.</p> <p>HI3231EN Formol Number</p> </div> <table border="1" style="width: 100%; border-collapse: collapse; margin-top: 5px;"> <tr> <td style="width: 15%;">Select</td> <td style="width: 15%;">New Method</td> <td style="width: 15%;">Reset to Default</td> <td style="width: 15%;">Page Up</td> <td style="width: 15%;">Page Down</td> </tr> </table>	Select	New Method	Reset to Default	Page Up	Page Down	<p style="text-align: center;">Confirmation of Reset Methods</p> <p style="text-align: center;">Are you sure you want to reset methods to default?</p> <table border="1" style="width: 100%; border-collapse: collapse; margin-top: 10px;"> <tr> <td style="width: 15%;">Reset</td> <td style="width: 15%;">Escape</td> <td style="width: 15%;"></td> <td style="width: 15%;"></td> <td style="width: 15%;"></td> </tr> </table>	Reset	Escape			
Select	New Method	Reset to Default	Page Up	Page Down							
Reset	Escape										

## 5.3 User Methods

These methods are defined by the user (usually by modifying a standard method). The user methods can be developed in accordance with the requirements of the user. All method parameters can be modified by the user.

### 5.3.1 Creating User Methods

To create a new user method, start from a standard or user method and follow these steps:

- Press  from the main screen.
- Using the  and  keys, highlight an existing method from the method list.
- Press . A new user method will be generated.
- Press  to activate the new user method.

<p style="text-align: center;">Analysis Methods</p> <p>Select the method to be activated.</p> <div style="border: 1px solid black; padding: 2px;"> <p><b>HI0001EN 0.1N Sodium Hydroxide</b></p> <p>HI0003EN 0.1M Na2S2O3 Titr. Conc.</p> <p>HI0015EN 0.01N Sodium Hydroxide</p> <p>HI0204EN 0.02N Iodine</p> <p>HI3204EN Titratable Acidity pH7.0</p> <p>HI3205EN Titratable Acidity pH8.2</p> <p>HI3208EN Volatile Acidity</p> <p>HI3213EN Free Sulfur Dioxide</p> <p>HI3216EN Total Sulfur Dioxide</p> <p>HI3217EN Reducing Sugar - Blank</p> <p>HI3218EN Reducing Sugar - Cal.</p> <p>HI3219EN Reducing Sugar</p> <p>HI3230EN Formal Number - pH adj.</p> <p>HI3231EN Formol Number</p> </div> <table border="1" style="width: 100%; border-collapse: collapse; margin-top: 5px;"> <tr> <td style="width: 15%;">Select</td> <td style="width: 15%;">New Method</td> <td style="width: 15%;">Reset to Default</td> <td style="width: 15%;">Page Up</td> <td style="width: 15%;">Page Down</td> </tr> </table>	Select	New Method	Reset to Default	Page Up	Page Down	<p style="text-align: center;">14:10:55 Mar 20, 2018</p> <p style="text-align: center;">copy of Free Sulfur Diox</p> <p style="text-align: center; font-size: 2em;">0.0 ppm (mg/L)</p> <p style="text-align: center;"><b>No Result</b></p> <p style="text-align: center;">Pump 1 Selected</p> <p>ATC 25.5 °C      End Point Volume 0.000 mL      mV -136.5</p> <table border="1" style="width: 100%; border-collapse: collapse; margin-top: 5px;"> <tr> <td style="width: 15%;">General Options</td> <td style="width: 15%;">Select Method</td> <td style="width: 15%;">Method Options</td> <td style="width: 15%;">Burette</td> <td style="width: 15%;">Mode</td> </tr> </table>	General Options	Select Method	Method Options	Burette	Mode
Select	New Method	Reset to Default	Page Up	Page Down							
General Options	Select Method	Method Options	Burette	Mode							

# TITRATION METHODS

## 5.3.2 Deleting User Methods

To remove a user method, press **Select Method** from the main screen. Highlight the user method that you want to delete and press **Delete**. A screen will appear in order to confirm the deletion. Press **Delete** again to confirm, or press **Escape** to cancel the operation.

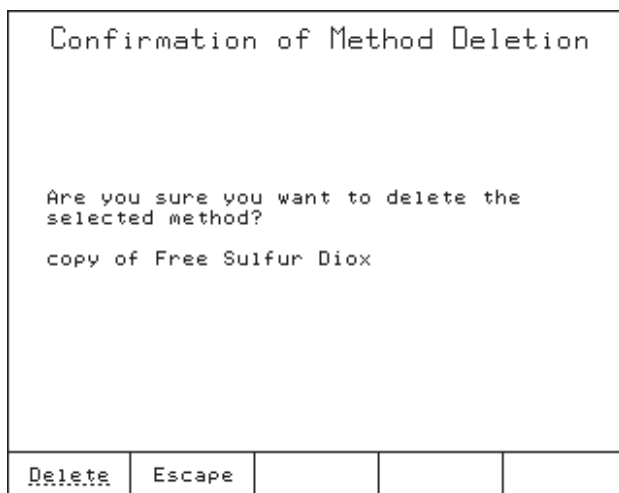

## 5.4 View / Modify Method

To modify the method parameters, press **Method Options** from the main screen. A list of all the parameters for the selected method will be displayed. Using the  $\triangle$  and  $\nabla$  keys, highlight the option that you want to modify and choose **Select**.

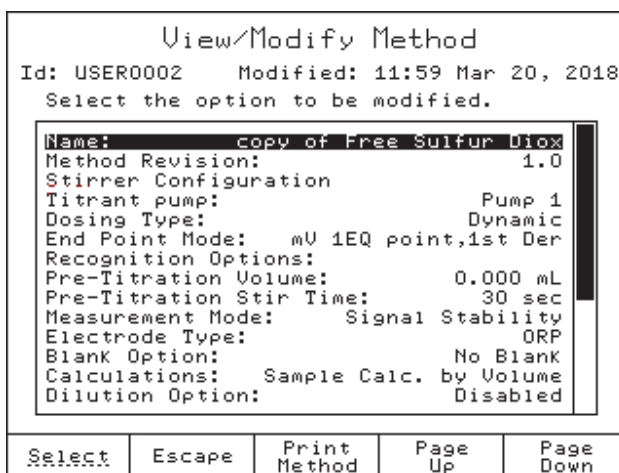



To exit the **View / Modify Method** screen, press Escape.

You can choose to save the modifications or to discard them.

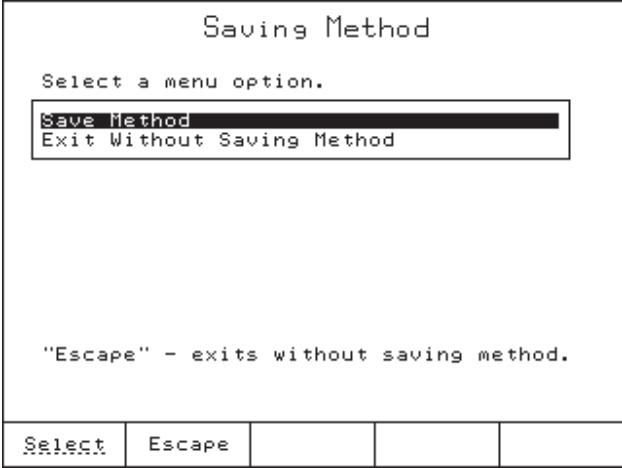

## 5.5 Method Options

**Note:** Only certain method options can be changed for Standard methods.

### 5.5.1 Name

Enter a name for the new method (up to 24 characters). Use the arrow keys to navigate through the character table. Press enter to add the highlighted character to the name.

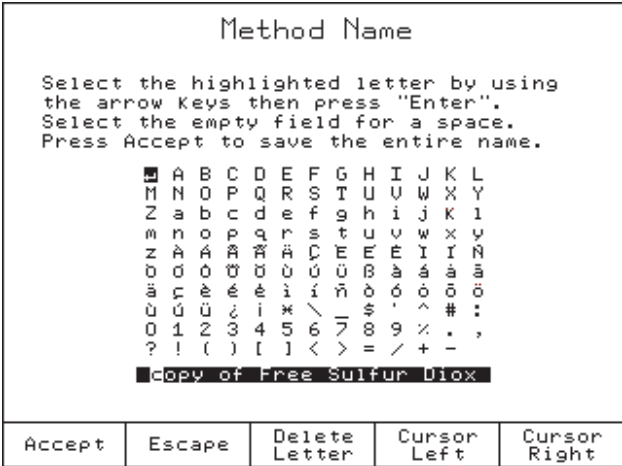

# TITRATION METHODS

## 5.5.2 Method Revision

A string representing the current method revision can be entered. The revision string format should be "X.Y", where X and Y are numerical digits.

Method Revision

Select the highlighted letter by using the arrow keys then press "Enter".  
Select the empty field for a space.  
The revision string format is "X.X".

█	A	B	C	D	E	F	G	H	I	J	K	L
M	N	O	P	Q	R	S	T	U	V	W	X	Y
Z	a	b	c	d	e	f	g	h	i	j	k	l
m	n	o	p	q	r	s	t	u	v	w	x	y
z	À	Á	Â	Ã	Ä	Å	Ç	È	É	Ê	Ë	Ì
Í	Î	Ï	Ñ	Ò	Ó	Ô	Õ	Ö	Ø	à	á	â
ã	ä	å	ç	è	é	ê	ë	ì	í	î	ï	ñ
ò	ó	ô	õ	ö	ø	ù	ú	û	ü	í	*	\
_	\$	'	^	#	:	0	1	2	3	4	5	6
7	8	9	%	.	,	?	!	(	)	[	]	<
>	=	/	+	-								

█ 2 . 0 █

Accept	Escape	Delete Letter	Cursor Left	Cursor Right
--------	--------	---------------	-------------	--------------

## 5.5.3 Stirrer Configuration

Select the stirrer to be used for the titration/analysis and set the stirrer speed.

<p style="text-align: center;">Stirrer Configuration</p> <p>Select a menu option.</p> <pre> Stirrer:          Stirrer 1 Stirring Speed:                 Disabled                 Stirrer 1             </pre>	<p style="text-align: center;">Stirring Speed</p> <p>Enter the speed of the stirrer within below range.</p> <p style="text-align: center;"><b>1400</b> RPM</p> <p>The range is from 200 to 2500 RPM.</p>								
<table border="1" style="width: 100%; border-collapse: collapse;"> <tr> <td style="width: 25%;">Select</td> <td style="width: 25%;">Escape</td> <td style="width: 25%;"></td> <td style="width: 25%;"></td> </tr> </table>	Select	Escape			<table border="1" style="width: 100%; border-collapse: collapse;"> <tr> <td style="width: 25%;">Accept</td> <td style="width: 25%;">Escape</td> <td style="width: 25%;">Delete Digit</td> <td style="width: 25%;"></td> </tr> </table>	Accept	Escape	Delete Digit	
Select	Escape								
Accept	Escape	Delete Digit							

## 5.5.4 Pump Configuration

Choose the pump that will be used for the titration.

View/Modify Method				
Id: USER0004    Modified: 14:10 Mar 20, 2018				
Select the option to be modified.				
<pre> Name:          copy of Free Sulfur Diox Method Revision: 1.0 Stirrer Configuration Titrant pump:  Pump 1 Dosing Type: End Point Mode: mV 1EQ point Recognition Options: Pre-Titration Volume: Pre-Titration Stir Time: 30 sec Measurement Mode:  Signal Stability Electrode Type:    ORP Blank Option:     No Blank Calculations:     Sample Calc. by Volume Dilution Option:  Disabled             </pre>				
Select	Escape	Print Method	Page Up	Page Down

# TITRATION METHODS

## 5.5.5 Dosing Type

The Titrator has two dosing types: *Linear Dosing* and *Dynamic Dosing*.

Dosing Type

Select the dosing type.

Linear Dosing  
Dynamic Dosing

Select    Escape            

### 5.5.5.1 Linear Dosing

Linear dosing dispenses a pre-defined volume of titrant with every addition.

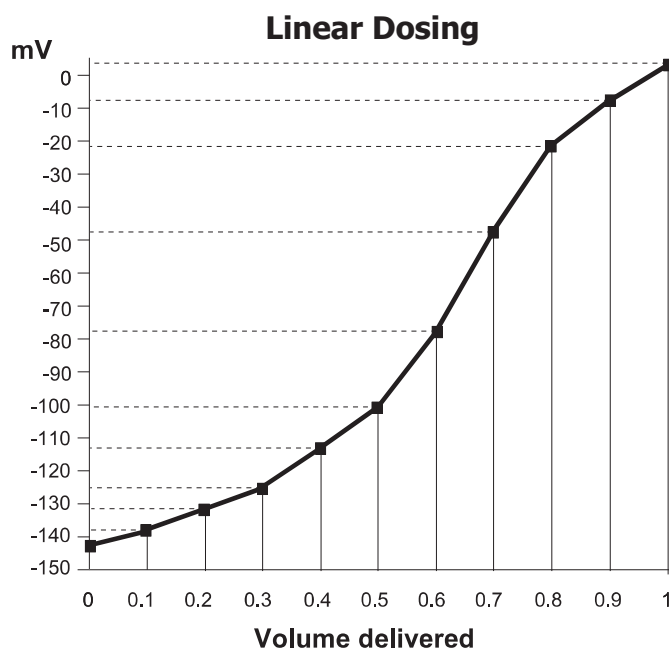

The *Linear Dosing* option is recommended for titrations with a slower reaction rate, difficult nonaqueous titrations, and specific applications.

**Note:** For steep and normal titration curves, smaller volume increments are recommended, to obtain many points around the equivalence point.  
For flat titration curves, larger volume increments are recommended for equivalence point detection.

To set the dosing volume, select *Linear Dosing* and enter the optimum dose.

Dosing volume ranges are:

5 mL burette	0.001	to	4.750 mL
10 mL burette	0.001	to	9.500 mL
25 mL burette	0.005	to	23.750 mL
50 mL burette	0.005	to	47.500 mL

### 5.5.5.2 Dynamic Dosing

The Titrator determines the titrant dose by trying to maintain a certain potential change (*delta E*) with each addition.

After a titrant dose, if the potential change is lower than the set *delta E*, the next dose will be progressively increased until *max Vol* is attained. If the potential change is still lower than the set value, the titration will continue with *max Vol* doses.

After a titrant dose, if the potential change is higher than the set *delta E*, the next dose will be progressively decreased until *min Vol* is attained. If the potential change is still higher than the set value, the titration will continue with *min Vol* doses.

The titrant is added in volumes that depend on the proximity of the end point as shown in the graph below.

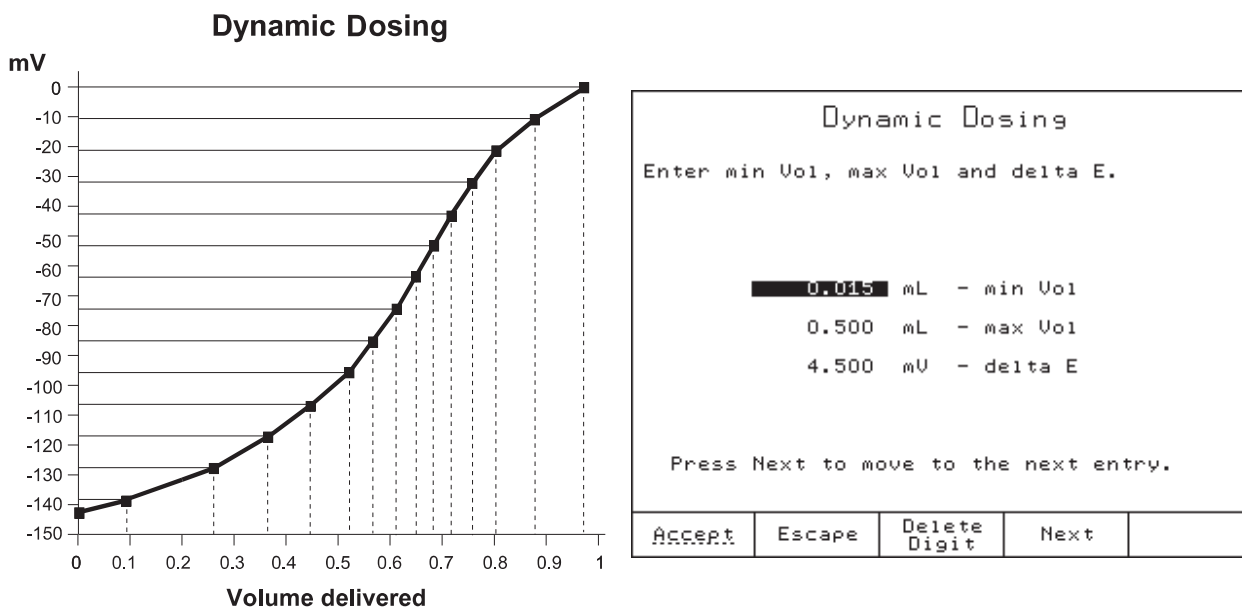

Dynamic dosing allows for larger doses far from the end point, reducing the total titration time. Closer to the end point, smaller doses are made, providing more data and improved accuracy.

# TITRATION METHODS

---

The following parameters must be set:

*min Vol*: The smallest dose to be dispensed during a titration.

The *min Vol* must be greater than or equal to:

0.001 mL for a 5 mL burette

0.001 mL for a 10 mL burette

0.005 mL for a 25 mL burette

0.005 mL for a 50 mL burette

*max Vol*: The largest dose to be dispensed during a titration.

The *max Vol* must be less than or equal to 4.000 mL.

*delta E*: Sets the fixed potential jump that has to be achieved after each titrant dose.

The allowed range is between 0.1 and 99.999 mV.

## **Recommendations for dosing parameters:**

For steep and normal titration curves the recommended settings are:

*delta E* 3.5 to 9 mV

*min Vol* 0.010 to 0.025 mL (for a 25 mL burette)

*max Vol* 0.075 to 0.250 mL (for a 25 mL burette)

For flat titration curves the recommended settings are:

*delta E* 10 to 15 mV

*min Vol* 0.050 to 0.150 mL (for a 25 mL burette)

*max Vol* 0.400 to 0.600 mL (for a 25 mL burette)

To achieve the highest levels of accuracy and reproducibility, it is recommended that 20-80% of the nominal burette volume used for each titration is consumed. If lower volumes of titrant are required, a smaller burette can be used.

## **5.5.6 End Point Mode**

Titration End Point Mode								
Select the end point detection.								
<table><tr><td>Equivalence End Point (pH)</td></tr><tr><td>Equivalence End Point (mV)</td></tr><tr><td><b>Fixed End Point (pH)</b></td></tr><tr><td>Fixed End Point (mV)</td></tr></table>					Equivalence End Point (pH)	Equivalence End Point (mV)	<b>Fixed End Point (pH)</b>	Fixed End Point (mV)
Equivalence End Point (pH)								
Equivalence End Point (mV)								
<b>Fixed End Point (pH)</b>								
Fixed End Point (mV)								
Select	Escape							

## 5.5.6.1 Fixed End Point (pH or mV)

### Fixed End Point (pH):

The titration is terminated when the preset pH value has been exceeded. The end point volume is a calculated value based on the dispensed volume when pH is under the preset value and the dispensed volume when pH exceeded the preset value.

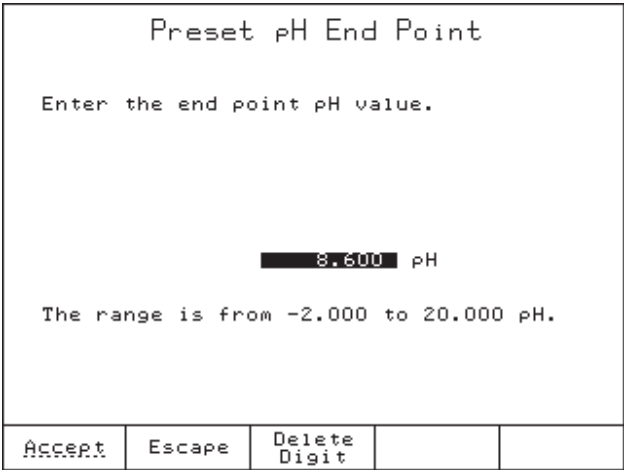

The range is from - 2.000 to 20.000 pH.

### Fixed End Point (mV):

The end point detection algorithm is the same as for pH, but the threshold value is expressed in mV.

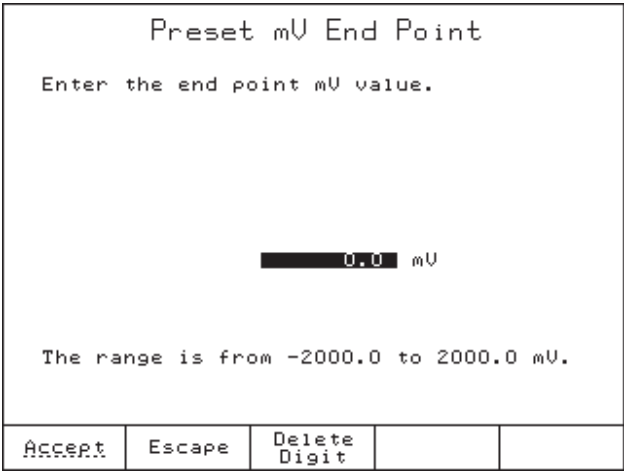

The range is from - 2000.0 to 2000.0 mV.

# TITRATION METHODS

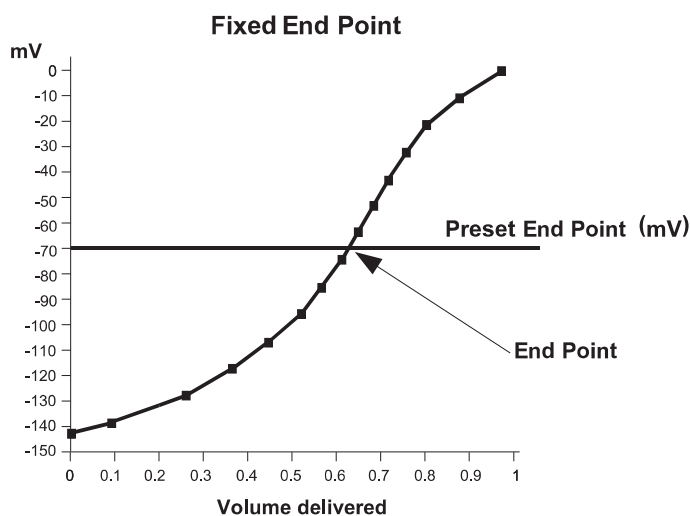

## 5.5.6.2 Equivalence End Point (pH or mV)

The titration is normally terminated when the equivalence point is detected (the point where the added quantity of titrant equals the quantity of analyte present in the sample).

### End Point Determination

The first and the second derivative of the titration curve can be used to detect the equivalence point.

End Point Determination

Select the end point determination.

1st derivative

2nd derivative

Select	Escape			
--------	--------	--	--	--

The equivalence point detection algorithm requires three additional titrant doses to be dispensed after the equivalence point is reached.

The reported end point volume is a calculated value based on a number of points around the equivalence point.

The potentiometric titration curve is the response in mV potential or pH between the indication of the electrode versus the volume of titrant added.

The inflection point of the titration curve is assumed to be the equivalence point of the



chemical reaction.

For non-symmetric titration curves, the theoretical error can be reduced by using the dynamic dosing.

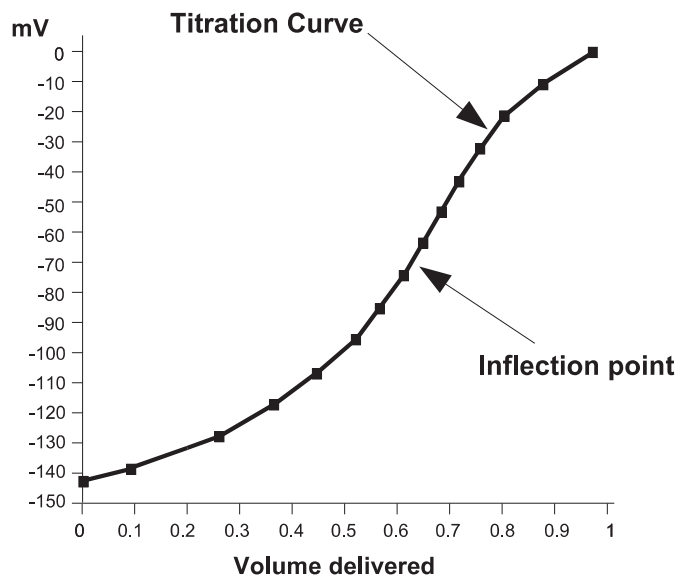

1st Derivative:

When first derivative is used to recognize the equivalence point, the titration curve inflection point (EQP) is the point where the first derivative reaches its maximum value.

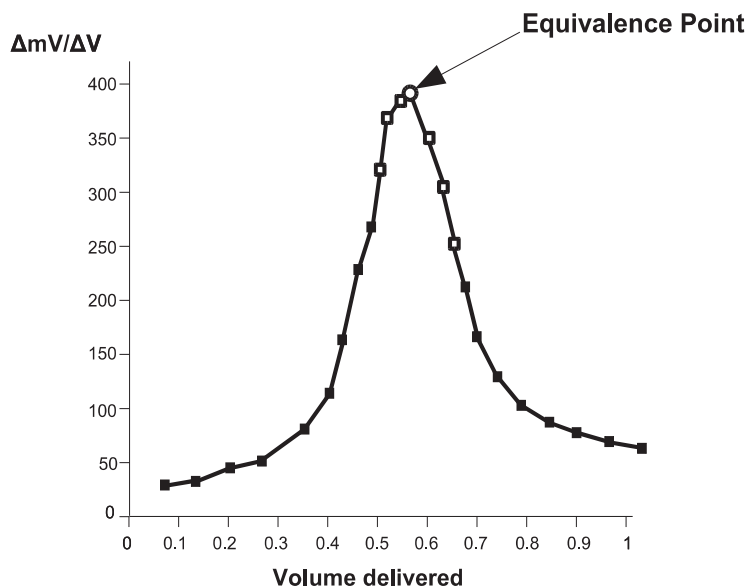

The detection algorithm looks for the maximum value of the first derivative. The first derivative must be greater than the threshold value at the maximum point (see **Recognition Options** section).

# TITRATION METHODS

## 2nd Derivative:

When second derivative is used to recognize the equivalence point, the titration curve inflection point (EQP) is the point where the second derivative crosses zero.

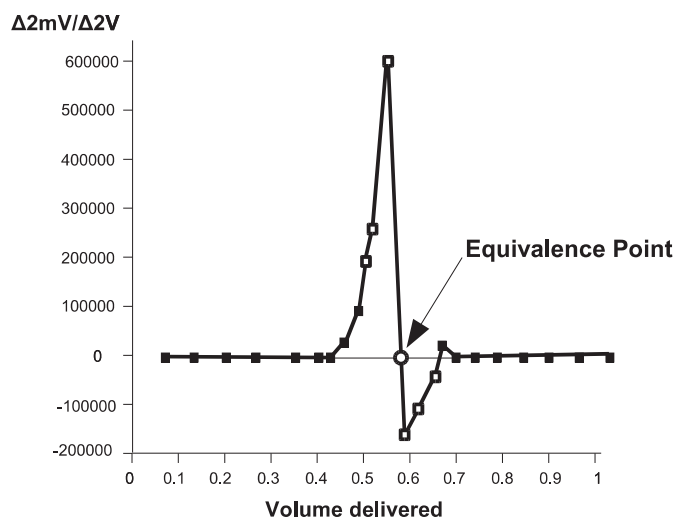

The detection algorithm looks for the point where the second derivative changes sign. The checked point, or first derivative, must be greater than the threshold value (see **Recognition Options** section).

### 5.5.7 Recognition Options (Equivalence End Point only)

The **Recognition Options** screen is a set of parameters used to avoid false detection of the equivalence point due to the chemical system (titrant / sample species and concentrations) and / or electrode response.

The **Recognition Options** screen is available only when *Equivalence End Point (pH or mV)* option is selected.

Recognition Options				
Select the options for equivalence point recognition.				
Threshold	500 mV/mL			
Range	NO			
Filtered Derivatives	NO			
Select	Escape			

## 5.5.7.1 Threshold

This parameter must be set by the user according to the analysis. The threshold represents the absolute value of the first derivative, expressed in mV/mL, below which the detection algorithm does not search for the equivalence point.

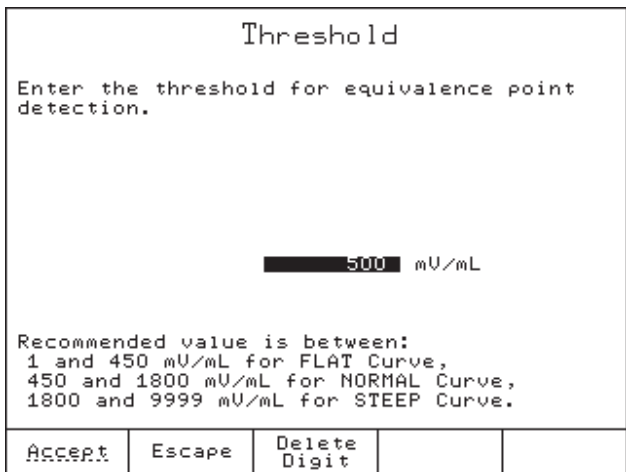

Range is between 1 and 9999 mV/mL. The recommended value is 40% of the absolute value of the first derivative.

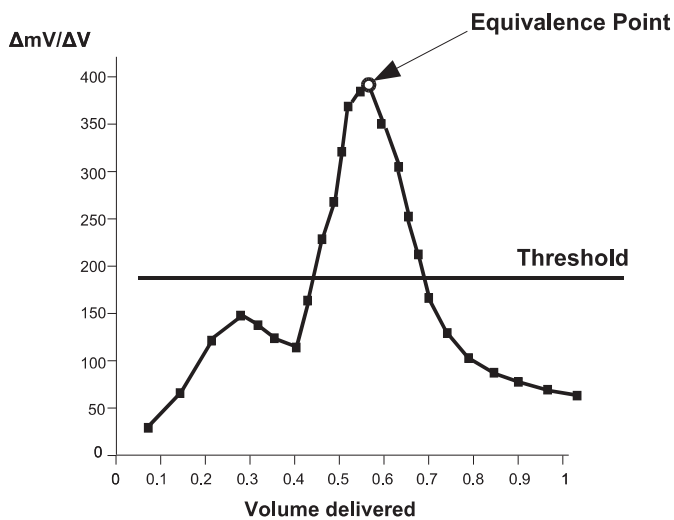

Depending on the titration curve profile, the following guide can be used:

TITRATION CURVE PROFILE	THRESHOLD (mV/mL)
Flat	1 to 450
Normal	50 to 1800
Steep	1800 to 9999

# TITRATION METHODS

## 5.5.7.2 Range

Range is an optional feature for equivalence point recognition. The Titrator will only look for an equivalence point between the set values.

The *Range* option can be enabled by selecting *YES* in the **Range Options** screen.

<p style="text-align: center;">Range Options</p> <p>Select option for equivalence point range.</p> <table border="1"><tr><td>NO</td></tr><tr><td><b>YES</b></td></tr></table> <p>"NO" - without equivalence point range. "YES" - with equivalence point range.</p> <table border="1"><tr><td>Select</td><td>Escape</td><td></td><td></td><td></td></tr></table>					NO	<b>YES</b>	Select	Escape				<p style="text-align: center;">Range Limits</p> <p>Enter Limit 1 and Limit 2 for range.</p> <p style="text-align: center;"><b>-2.0</b> mV - Limit 1 20.0 mV - Limit 2</p> <table border="1"><tr><td>Accept</td><td>Escape</td><td>Delete Digit</td><td>Next</td><td></td></tr></table>					Accept	Escape	Delete Digit	Next	
NO																					
<b>YES</b>																					
Select	Escape																				
Accept	Escape	Delete Digit	Next																		

pH Range -2.000 to 20.000 pH

mV Range -2000.0 to 2000.0 mV

The Limit 2 value must not be equal to the Limit 1 value.

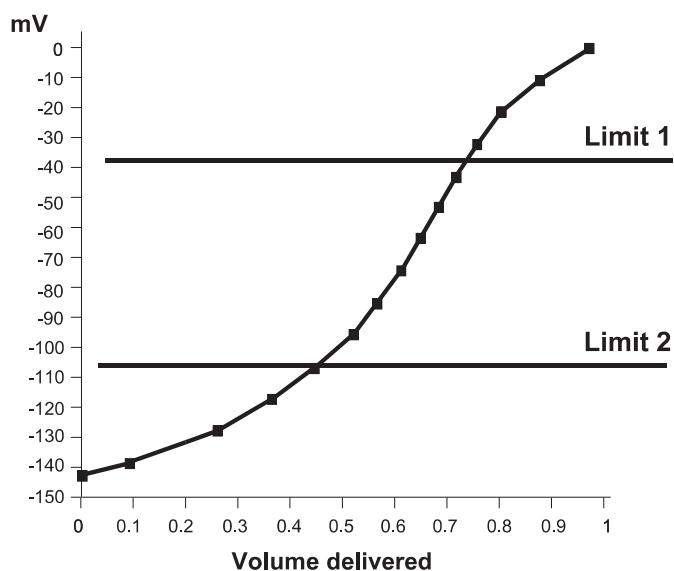

## 5.5.7.3 Filtered Derivatives

This option adds a filtering procedure in the 1<sup>st</sup> and 2<sup>nd</sup> derivative computation algorithm that reduces the influence of pH or mV noise.

The *Filtered Derivatives* option can be enabled by selecting *YES* in the **Filtered Derivatives Option** screen.

Filtered Derivatives Option

Select option for filtered derivatives.

NO

**YES**

"NO" - without filtered derivatives.  
"YES" - with filtered derivatives.

Select	Escape		
--------	--------	--	--

Noise can be due to:

- Chemical system properties (sample, titrant, solvent), such as slow chemical reactions or unbuffered samples such as wastewater, tap water, wine
- Electrode response
- Incorrect method parameters settings such as *Signal Stability*, *Stirring Speed*, etc.
- Insufficient titrant additions

**Note:** A shift in the end point volume by 1 or 2 doses may be seen due to filtering.

## 5.5.8 Pre-Titration Volume

During a titration, the equivalence point is reached after many titrant doses. These doses take up extra time while having no relevance for equivalence point detection.

Pre-titration volume adds a large initial dose to jump directly to the proximity of the equivalence point. This first dose occurs after the pre-titration stir time is completed.

The ranges for pre-titration volumes are shown below:

- 0.001 to 4.750 mL for a 5 mL burette
- 0.001 to 9.500 mL for a 10 mL burette
- 0.005 to 23.750 mL for a 25 mL burette
- 0.005 to 47.500 mL for a 50 mL burette

## TITRATION METHODS

---

Pre-Titration Volume				
Enter the initial titrant volume to be dispensed.				
9.000 mL				
Press Help to view the valid ranges for the pre-titration volume.				
Accept	Escape	Delete Digit		

To disable a pre-titration volume, enter 0.000 mL.

**Note:** A pre-titration volume is highly recommended whenever possible. Fewer doses will considerably shorten the overall titration duration.

### 5.5.9 Pre-Titration Stir Time

When enabled, the sample is mixed for a set period of time before any titrant is added. This allows the sample to become homogeneous.

The range is from 0 to 180 seconds.

Pre-Titration Stir Time				
Enter the initial mixing time prior to the start of the titration.				
10 seconds				
The range is from 0 to 180 seconds.				
Accept	Escape	Delete Digit		

The *Pre-Titration Stir Time* option is disabled if 0 seconds is entered.

### 5.5.10 Measurement Mode

During titration, the acquisition of the potential (mV) value of the solution can be done in two ways: by using either *Signal Stability* or *Timed Increment* option.

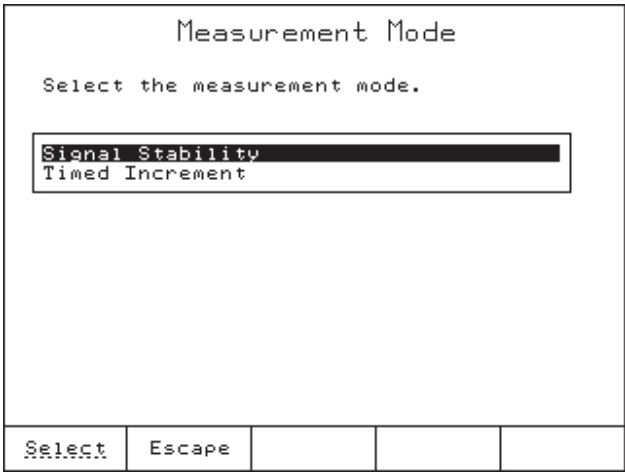

### 5.5.10.1 Signal Stability

When *Signal Stability* is selected, the Titrator acquires the potential (mV) only when stable conditions are reached.

The principles of signal stability are plotted below:

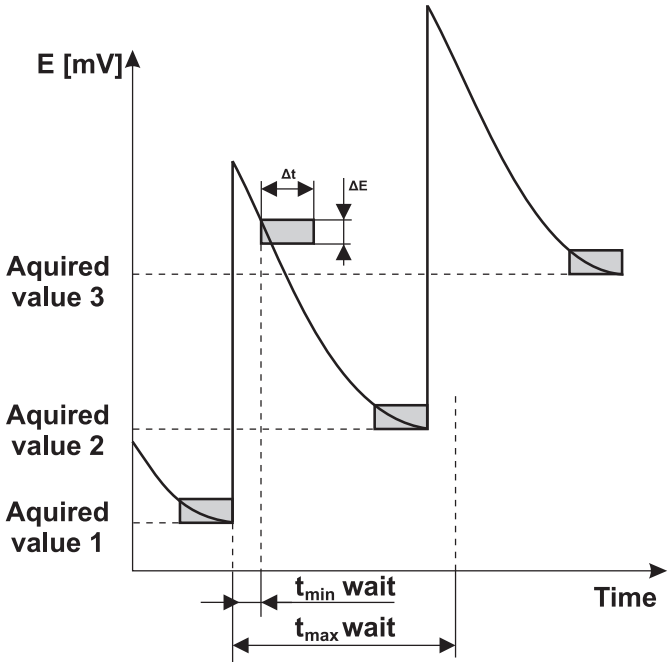

The signal stability window (condition) represents the time interval ( $\Delta t$ ) during which the potential measured in solution (mV) is confined inside the potential interval ( $\Delta E$ ).

The new signal value is acquired if the stability condition is reached after the minimum ( $t_{min}$ ) wait time.

## TITRATION METHODS

---

If the stability condition is not reached and the maximum ( $t_{max}$ ) wait time has elapsed, the potential is acquired.

Signal Stability				
Enter mV variation ( $\Delta E$ ) in the time interval ( $\Delta t$ ) min and max wait time period to the next sample measurement.				
0.3 mV - $\Delta E$				
1.5 seconds - $\Delta t$				
5 seconds - $t_{min}$ wait				
30 seconds - $t_{max}$ wait				
Accept	Escape	Delete Digit	Next	

- $\Delta E$  - maximum change in potential during  $\Delta t$   
The range is from 0.1 to 99.9 mV.
- $\Delta t$  - the time interval during which the potential is measured.  
The range is from 0.5 to 10.0 seconds.
- $t_{min}$  wait - the minimum elapsed time before a stability check. This is also the minimum elapsed time between two doses.  
The range is from 2 seconds to  $t_{max}$  wait time.
- $t_{max}$  wait - the maximum elapsed time between two successive doses. If the  $t_{max}$  wait has elapsed, a new dose is added even if the signal stability condition is not reached.  
The range is from  $t_{min}$  wait time to 180 seconds.



## 5.5.10.2 Timed Increment

When *Timed Increment* is selected, the Titrator acquires the potential (mV) at a fixed time interval (no signal stability check). The time period between two acquisitions must be set according to the reaction and the response time of the electrode.

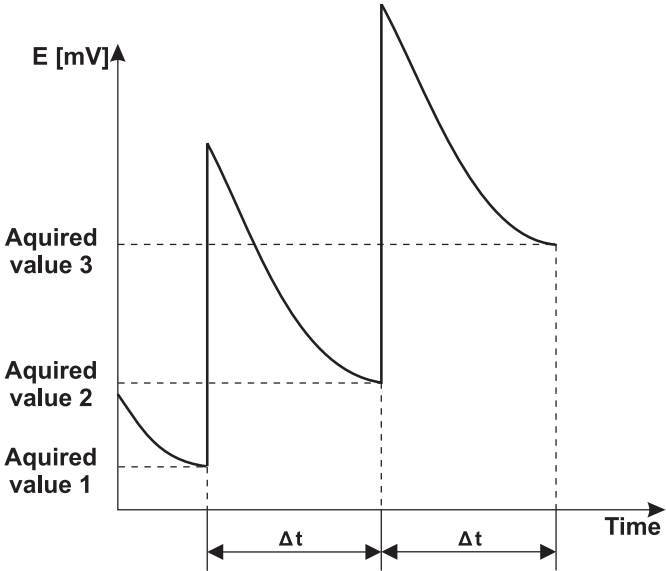

```
Timed Increment
Enter the period of time to wait until
the next dose.

      5 seconds

The range is from 2 to 180 seconds.

Accept  Escape  Delete
Digit
```

The range is from 2 to 180 seconds.

# TITRATION METHODS

## 5.5.11 Electrode Type

Enter the type of the electrode, up to 20 characters.

Electrode Type

Select the highlighted letter by using the arrow keys then press "Enter".  
Select the empty field for a space.  
Press Accept to save the electrode type.

█	A	B	C	D	E	F	G	H	I	J	K	L					
	M	N	O	P	Q	R	S	T	U	V	W	X	Y				
	Z	a	b	c	d	e	f	g	h	i	j	k	l				
	m	n	o	p	q	r	s	t	u	v	w	x	y				
	z	À	Á	Â	Ã	Ä	Å	Ç	È	É	Ê	Ë	Ì	Í	Î	Ï	Ñ
	Ò	Ó	Ô	Õ	Ö	Ù	Ú	Û	Ü	Ý	à	á	â	ã	ä	å	æ
	ç	è	é	ê	ë	ì	í	î	ï	ò	ó	ô	õ	ö	ø	ù	ú
	û	ü	ý	ÿ	ı	ı	ı	ı	ı	ı	ı	ı	ı	ı	ı	ı	ı
	0	1	2	3	4	5	6	7	8	9	.	,	'	^	#	:	;
	?	!	(	)	[	]	<	>	=	/	+	-	~	~	~	~	~

█PIL

Accept	Escape	Delete Letter	Cursor Left	Cursor Right
--------	--------	---------------	-------------	--------------

## 5.5.12 Blank Option

This feature allows the user to select the procedure for the blank calculations (where  $V$  is the volume of titrant dispensed during the titration and  $Blank$  is the volume of titrant consumed by the blank sample).

View/Modify Method

Id: USER0004      Modified: 14:10 Mar 20, 2018

Select the option to be modified.

Name:	copy of Free Sulfur Diox
Method Revision:	1.0
Stirrer Configuration	
Titration pump:	Pump 1
Dosing Type:	Dynamic
End Point Mode:	mV 1EQ point,1st Der
Recognition Options:	
Pre-Titration Volume:	U - Blank
Pre-Titration Stir Time:	Blank - U
Measurement Mode:	Sign: No Blank
Electrode Type:	
Blank Option:	No Blank
Calculations:	Sample Calc. by Volume
Dilution Option:	Disabled

Select	Escape	Print Method	Page Up	Page Down
--------	--------	--------------	---------	-----------

If one of the options ( $V$ -Blank or  $Blank$ - $V$ ) is selected in the **View / Modify Method** screen, the **Blank Value** will be active on the View/Modify Method screen and the value of the blank can be set (in liters).

Blank Value

Enter the blank volume in liters.

~~1.2580E-8~~ L

Accept	Escape	Delete Digit	
--------	--------	-----------------	--

### 5.5.13 Calculations

The final result is calculated using the end point volume (titrant volume at the equivalence point or at the fixed end point), and a formula selected by the user.

Calculations

Select either the calculation to be performed or modify the variables.

Edit Variable Values  
No Formula (mL only)  
No Formula (L only)  
Sample Calc. by Weight  
Sample Calc. by Volume  
**Stdz. Titrant by Weight**  
Stdz. Titrant by Volume  
Generic Formula

Select	Escape		
--------	--------	--	--

#### 5.5.13.1 Edit Variable Values

Edit the variables in a previously selected calculation. For each formula, selected variables can be changed.

#### 5.5.13.2 No Formula (mL only)

Only the volume of titrant (mL) required to reach the end point will be displayed.

#### 5.5.13.3 No Formula (L only)

Only the volume of titrant (L) required to reach the end point is displayed.

# TITRATION METHODS

## 5.5.13.4 Sample Calculations by Weight

This calculation is used when the concentration of an analyte is determined by the weight of the sample. The results are based on the initial sample weight (in grams).

The Titrator will calculate the results based on the selected units.

Titrant Units					Final Result Units				
Select the titrant unit.					Select the unit for your results.				
<div style="border: 1px solid black; padding: 2px;">M (mol/L) N (eq/L) g/L mg/L</div>					<div style="border: 1px solid black; padding: 2px;">ppt (g/Kg) ppm (mg/Kg) ppb (µg/Kg) % = (g/100g) mg/g mg/Kg mol/Kg mmol/g eq/Kg meq/Kg</div>				
Select	Escape				Select	Escape			

The Titrator will provide the results based on the titrant and sample units selected.

Titrant Units:

M (mol/L)	moles/liter
N (eq/L)	equivalents/liter
g/L	grams/liter
mg/L	milligrams/liter

Final Result Units:

ppt (g/kg)	parts per thousand (grams/kilogram)
ppm (mg/kg)	parts per million (milligrams/kilogram)
ppb (µg/kg)	parts per billion (micrograms/kilogram)
% (g/100 g)	percentage in weight (grams/100 grams)
mg/g	milligrams/gram
mg/kg	milligrams/kilogram
mol/kg	moles/kilogram
mmol/g	millimoles/gram
eq/kg	equivalents/kilogram
meq/kg	milliequivalents/kilogram

# TITRATION METHODS

A formula example is shown below using M (mol/L) as the titrant unit and ppt (g/kg) as the final result unit:

Calculating Sample Concentration

M (mol/L) --> ppt (g/kg)

The calculation is:

$$\frac{U \times \frac{\text{mol}}{\text{L}} \times \frac{\text{mol}}{\text{mol}} \times \frac{\text{g}}{\text{mol}}}{\frac{\text{g}}{\text{kg}} \times 1000\text{g}}$$

Select the variables to change value.  
U = volume dispensed in liters.

1.000 mol/L -> titrant conc.

1.000 mol/mol -> (sample/titrant)

1.000 g/mol -> mw of sample

1.000 g -> sample weight

Select	Escape	Save / Exit	
--------	--------	----------------	--

Variables can be set according to the amount of sample and titrant used.

### 5.5.13.5 Sample Calculations by Volume

This calculation is used when the concentration of an analyte is determined in terms of the volume of sample. The results are based on the initial sample volume (in milliliters). The Titrator will calculate the results based on the selected units.

<p style="text-align: center;">Titrant Units</p> <p>Select the titrant unit.</p> <div style="border: 1px solid black; padding: 5px; margin: 5px 0;"> <p>M (mol/L)</p> <p>N (eq/L)</p> <p>g/L</p> <p>mg/L</p> </div>	<p style="text-align: center;">Final Result Units</p> <p>Select the unit for your results.</p> <div style="border: 1px solid black; padding: 5px; margin: 5px 0;"> <p>ppt (g/L)</p> <p>ppm (mg/L)</p> <p>ppb (ug/L)</p> <p>M (mol/L)</p> <p>N (eq/L)</p> <p>g/L</p> <p>mg/L</p> <p>ug/L</p> <p>mol/L</p> <p>mmol/L</p> <p>mg/mL</p> <p>mg/100mL</p> <p>g/100 mL</p> <p>eq/L</p> </div>								
<table border="1" style="width: 100%; border-collapse: collapse;"> <tr> <td style="width: 25%; text-align: center;">Select</td> <td style="width: 25%; text-align: center;">Escape</td> <td style="width: 25%;"></td> <td style="width: 25%;"></td> </tr> </table>	Select	Escape			<table border="1" style="width: 100%; border-collapse: collapse;"> <tr> <td style="width: 25%; text-align: center;">Select</td> <td style="width: 25%; text-align: center;">Escape</td> <td style="width: 25%; text-align: center;">Page Up</td> <td style="width: 25%; text-align: center;">Page Down</td> </tr> </table>	Select	Escape	Page Up	Page Down
Select	Escape								
Select	Escape	Page Up	Page Down						

- Titrant Units:
- |           |                   |
|-----------|-------------------|
| M (mol/L) | moles/liter       |
| N (eq/L)  | equivalents/liter |
| g/L       | grams/liter       |
| mg/L      | milligrams/liter  |

# TITRATION METHODS

Final Result Units:

ppt (g/L)	parts per thousand (grams/liter)
ppm (mg/L)	parts per million (milligrams/liter)
ppb (µg/L)	parts per billion (micrograms/liter)
M (mol/L)	Molarity (moles/liter)
N (eq/L)	Normality (equivalents/liter)
mg/L	milligrams/liter
µg/L	micrograms/liter
mmol/L	millimoles/liter
mg/mL	milligrams/milliliter
mg/100 mL	milligrams/100 milliliters
g/100 mL	grams/100 milliliters
eq/L	equivalents/liter
meq/L	milliequivalents/liter

A formula example is shown below using N (eq/L) as the titrant units and g/L as the final result units:

Calculating Sample Concentration

N (eq/L) --> g/L

The calculation is:

$$\frac{U \times \frac{\text{eq}}{\text{L}} \times \frac{\text{mol}}{\text{eq}} \times \frac{\text{g}}{\text{mol}}}{\text{mL} \times \frac{\text{L}}{1000\text{mL}}}$$

Select the variables to change value.  
U = volume dispensed in liters.

1.000 eq/L -> titrant conc.

1.000 mol/eq -> (sample/titrant)

1.000 g/mol -> mw of sample

1.000 mL -> sample volume

Select	Escape	Save / Exit	
--------	--------	----------------	--

Variables can be set according to the amount of sample and titrant used.

### 5.5.13.6 Standardize Titrant by Weight

This calculation is used when the concentration of the titrant is determined using a solid standard. Determination of the titrant concentration is based on the primary standard weight (in grams).

The calculation is based on the selected titrant unit. If the titrant unit is M (mol/L), the formula used to calculate the result is displayed below:

<p style="text-align: center;">Titrant Units</p> <p>Select the titrant unit.</p> <div style="border: 1px solid black; padding: 5px; margin: 5px 0;"> M (mol/L)  <b>N (eq/L)</b>  g/L  mg/L </div>	<p style="text-align: center;">Calculating Titrant Concentration</p> <p>The titrant concentration unit is M (mol/L).</p> <p>The calculation is:</p> $\frac{g \times \frac{mol}{g} \times \frac{mol}{L}}{V}$ <p>Select the variables to change value.  V = volume dispensed in liters.</p> <div style="border: 1px solid black; padding: 5px; margin: 5px 0;"> 0.200 g -&gt; standard weight  204.23 g/mol -&gt; mw of standard  1.000 mol/mol -&gt; (titrant/standard) </div>								
<table border="1" style="width: 100%; border-collapse: collapse;"> <tr> <td style="width: 25%;">Select</td> <td style="width: 25%;">Escape</td> <td style="width: 25%;"></td> <td style="width: 25%;"></td> </tr> </table>	Select	Escape			<table border="1" style="width: 100%; border-collapse: collapse;"> <tr> <td style="width: 25%;">Select</td> <td style="width: 25%;">Escape</td> <td style="width: 25%;">Save / Exit</td> <td style="width: 25%;"></td> </tr> </table>	Select	Escape	Save / Exit	
Select	Escape								
Select	Escape	Save / Exit							

### 5.5.13.7 Standardize Titrant by Volume

This calculation is used when the concentration of the titrant is determined using a primary standard solution. Determination of the titrant concentration is based on the primary standard volume (in milliliters).

The Titrator will perform the calculation based on the titrant unit selected.

The calculation is based on the selected titrant unit. If the titrant unit is N (eq/L), the formula used to calculate the result is displayed below:

<p style="text-align: center;">Titrant Units</p> <p>Select the titrant unit.</p> <div style="border: 1px solid black; padding: 5px; margin: 5px 0;"> M (mol/L)  <b>N (eq/L)</b>  g/L  mg/L </div>	<p style="text-align: center;">Calculating Titrant Concentration</p> <p>The titrant concentration unit is N (eq/L).</p> <p>The calculation is:</p> $\frac{mL \times \frac{L}{1000mL} \times \frac{eq}{L}}{V}$ <p>Select the variables to change value.  V = volume dispensed in liters.</p> <div style="border: 1px solid black; padding: 5px; margin: 5px 0;"> 1.684 mL -&gt; standard volume  2.375 eq/L -&gt; standard conc. </div>								
<table border="1" style="width: 100%; border-collapse: collapse;"> <tr> <td style="width: 25%;">Select</td> <td style="width: 25%;">Escape</td> <td style="width: 25%;"></td> <td style="width: 25%;"></td> </tr> </table>	Select	Escape			<table border="1" style="width: 100%; border-collapse: collapse;"> <tr> <td style="width: 25%;">Select</td> <td style="width: 25%;">Escape</td> <td style="width: 25%;">Save / Exit</td> <td style="width: 25%;"></td> </tr> </table>	Select	Escape	Save / Exit	
Select	Escape								
Select	Escape	Save / Exit							

### 5.5.13.8 Generic Formula

The user can define their own calculation formula based on the final result units in a solid or liquid sample.

# TITRATION METHODS

## Final Result Units:

ppt (g/kg)	parts per thousand (grams/kilogram)
ppt (g/L)	parts per thousand (grams/liter)
ppm (mg/kg)	parts per million (milligrams/kilogram)
ppm (mg/L)	parts per million (milligrams/liter)
ppb (µg/kg)	parts per billion (micrograms/kilogram)
ppb (µg/L)	parts per billion (micrograms/liter)
% (g/100 g)	percentage in weight (grams/100 grams)
M (mol/L)	Molarity (moles/liter)
mg/g	milligrams/gram
N (eq/L)	Normality (equivalents/liter)
g/L	gram/liter
mg/kg	milligrams/kilogram
mg/L	milligrams/liter
mol/kg	moles/kilogram
µg/L	micrograms/liter
mol/L	moles/liter
mmol/g	millimoles/gram
eq/kg	equivalents/kilogram
mmol/L	millimoles/liter
meq/kg	milliequivalents/kilogram
mg/mL	milligrams/milliliter
mg/100 mL	milligrams/100 milliliters
g/100 mL	grams/100 milliliters
eq/L	equivalents/liter
meq/L	milliequivalents/liter
No Unit	No result unit

The Titrator will calculate the results based on the selected unit.

The formula can be either for titrant standardization or sample analysis.

Where:

<p style="text-align: center;">Final Result Units</p> <p>Select the unit for your results.</p> <div style="border: 1px solid black; padding: 2px;"> <p>                     % = (g/100g)                      mg/g                      mg/Kg                      mol/Kg                      mmol/g                      eq/Kg                      meq/Kg                      ppt (g/L)                      ppm (mg/L)                      ppb (µg/L)                      M (mol/L)                      N (eq/L)                      g/L                      mg/L                 </p> </div>	<p style="text-align: center;">Calculating Sample Concentration</p> <p style="text-align: center;">Final unit is mg/L.</p> <p style="text-align: center;">The calculation is:</p> $C * U * \frac{F1 * F2 * F3}{S}$ <p>Select the variables to change value. U = volume dispensed in liters.</p> <div style="border: 1px solid black; padding: 2px;"> <p>                     1.000 C -&gt; (titrant conc.)                      1.000 F1 -&gt; (general factor)                      1.000 F2 -&gt; (general factor)                      1.000 F3 -&gt; (general factor)                      1.000 S -&gt; (sample size)                 </p> </div>								
<table border="1" style="width: 100%; border-collapse: collapse;"> <tr> <td style="width: 25%;">Select</td> <td style="width: 25%;">Escape</td> <td style="width: 25%;">Page Up</td> <td style="width: 25%;">Page Down</td> </tr> </table>	Select	Escape	Page Up	Page Down	<table border="1" style="width: 100%; border-collapse: collapse;"> <tr> <td style="width: 25%;">Select</td> <td style="width: 25%;">Escape</td> <td style="width: 25%;">Save / Exit</td> <td style="width: 25%;"></td> </tr> </table>	Select	Escape	Save / Exit	
Select	Escape	Page Up	Page Down						
Select	Escape	Save / Exit							



- C = the concentration of the titrant  
F1 = general factor  
F2 = general factor  
F3 = general factor  
S = sample size, in grams or milliliters  
V = the volume delivered, in liters, to reach the preset or equivalence end point  
(determined by the Titrator)

## General factors:

### Weight Conversion:

One of the general factors should be a weight conversion factor.

Examples of concentration units:

mol/L	moles/Liter
eq/L	equivalents/Liter
g/L	grams/Liter
mg/L	milligram/Liter

### Reaction Ratio:

The reaction ratio is the ratio between the analyte and titrant or standard and titrant.

Examples of ratios:

mol/mol	moles of sample/moles of titrant
mol/eq	moles of sample/equivalents of titrant
eq/mol	equivalents of sample/moles of titrant
mol/mol	moles of titrant/moles of standard
eq/mol	equivalents of titrant/moles of standard

Example: 2 moles of NaOH react with 1 mole of H<sub>2</sub>SO<sub>4</sub>

### Unit Conversion factor:

Used to convert between various measurement units.

Examples: L/1000 → mL  
g/1000 → mg

### Weight Conversion factor:

Used to convert between weight measurement bases (kg, g, mg, µg or mole, mmole).

Example: g → mol

# TITRATION METHODS

## 5.5.14 Dilution Option

When the initial sample is diluted, a titration is made with an aliquot of the diluted sample, dilution calculations can be used.

The calculations are based on the original sample weight (volume) in order to express the results for the initial sample.

Dilution Parameters										
Select the option.										
<table border="1"><tr><td>Final Dilution Volume:</td><td>100.000 mL</td></tr><tr><td>Aliquot Volume:</td><td>10.000 mL</td></tr><tr><td>Analyte size to be diluted:</td><td>1.000 g</td></tr></table>					Final Dilution Volume:	100.000 mL	Aliquot Volume:	10.000 mL	Analyte size to be diluted:	1.000 g
Final Dilution Volume:	100.000 mL									
Aliquot Volume:	10.000 mL									
Analyte size to be diluted:	1.000 g									
Select	Escape									

*Final Dilution Volume:* The volume of the sample after dilution

*Aliquot Volume:* Sample volume used for the titration

*Analyte size to be diluted:* The initial sample weight (volume)

The sample size used in the calculations:

$$\frac{\text{Analyte size to be diluted} * \text{Aliquot Volume}}{\text{Final Dilution Volume}}$$

## 5.5.15 Titrant Name

Enter the name of the titrant (up to 20 characters). This name will appear in the titration report.

Titrant Name				
Select the highlighted letter by using the arrow keys then press "Enter". Select the empty field for a space. Press Accept to save the entered text.				
■ A B C D E F G H I J K L M N O P Q R S T U V W X Y Z a b c d e f g h i j k l m n o p q r s t u v w x y z A A A A A C E E E I I N b o o o o u u u B a a a a ä ç è é ê ì í ñ ò ó ô õ ö ù ú û ü ¿ i * \ _ \$ ' ^ # : 0 1 2 3 4 5 6 7 8 9 % . , ? ! ( ) [ ] < > = / + -				
■ O L N NaOH				
Accept	Escape	Delete Letter	Cursor Left	Cursor Right

**5.5.16 Titrant Concentration**

Enter the concentration of the titrant to be used. When determining the titrant concentration, only the concentration unit is displayed. The titrant concentration can not be set.

Titrant Concentration				
Enter the titrant concentration.				
0.10678 M (mol/L)				
ACCEPT	Escape	Delete Digit		

**5.5.17 Analyte Size**

Enter the size of the sample (for sample concentration determinations) or standard (for titrant concentration determination).

Sample Volume				
Enter the initial sample volume in milliliters.				
1.0000 mL				
This volume will be used when fixed sample size is selected.				
ACCEPT	Escape	Delete Digit		

# TITRATION METHODS

---

## 5.5.18 Analyte Entry

Select the analyte entry mode.

Analyte Entry						
Select the entry mode of analyte.						
<table border="1"><tr><td>Fixed Weight or Volume</td></tr><tr><td>Manual Weight or Volume</td></tr></table>					Fixed Weight or Volume	Manual Weight or Volume
Fixed Weight or Volume						
Manual Weight or Volume						
Verify the correct formula is being used, I.E. weight or volume analyte type.						
Select	Escape					

### 5.5.18.1 Fixed Weight or Volume

Each titration will use a set weight or volume in the calculations.

### 5.5.18.2 Manual Weight or Volume

Each titration, the exact weight or volume can be entered. The Titrator will prompt for the analyte weight or volume at the beginning of each titration.

## 5.5.19 Maximum Titrant Volume

The maximum titrant volume used in the titration must be set according to the analysis. If the titration end point (fixed or equivalence End Point) is not reached, the titration will be terminated after the maximum titrant volume has been dispensed. The error message ("Limits Exceeded") will appear on the display.

Maximum Titrant Volume					
Enter the maximum titrant volume to be dispensed.					
<table border="1"><tr><td>15.000</td></tr></table> mL					15.000
15.000					
Recommend the total volume of the burette.					
Accept	Escape	Delete Digit			

Range is from 0.100 to 100.000 mL.

---

## 5.5.20 Potential Range

The input potential range can be set by the user. The titration will be terminated and an error message will appear if the potential is outside these limits.

These limits provide protection against a titration that does not generate an end point due to potential over-range.

Potential Range				
Enter the upper and lower potential.				
2000.0 mV - Upper Limit				
-2000.0 mV - Lower Limit				
Press Next to move to the next entry.				
ACCEPT	Escape	Delete Digit	Next	

The ranges can be set between -2000.0 to 2000.0 mV.

## 5.5.21 Volume/Flow Rate

The flow rate for the dosing system can be set by the user in an interval of 0.1 to two times the burette volume:

- 0.1 to 10 mL/min for a 5 mL burette
- 0.1 to 20 mL/min for a 10 mL burette
- 0.1 to 50 mL/min for a 25 mL burette
- 0.1 to 100 mL/min for a 50 mL burette

Flow Rate				
Enter the titrant flow rate.				
50.0 mL/min				
The range is from 0.1 to twice the total volume of the burette.				
ACCEPT	Escape	Delete Digit		

**Note:** The Titrator will automatically detect the burette size and display the correct high limit volume.

The flow rate is set for all burette operations.

# TITRATION METHODS

## 5.5.22 Signal Averaging

This option enables filtering on the mV/pH reading.

If *1 Reading* is selected, the filtering is disabled. The Titrator will take the last reading and place it into a "moving window" along with the last 2, 3 or 4 readings (depending on the selected option). The average of those readings is displayed and used for calculations.

Averaging more readings is helpful when a noisy signal is received from the electrode.

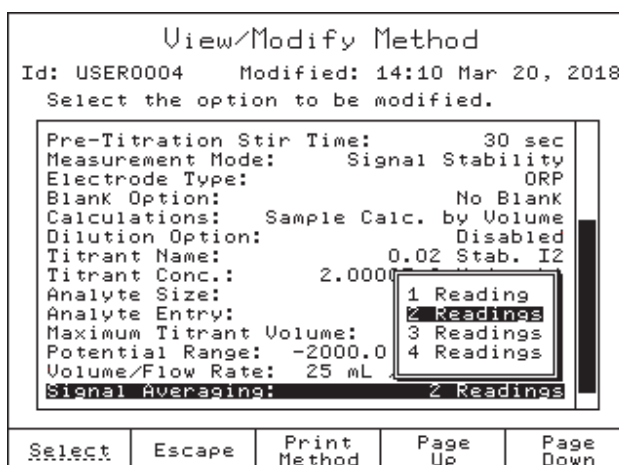

## 5.5.23 Significant Figures

This option allows you to set the format for displaying the final titration result.

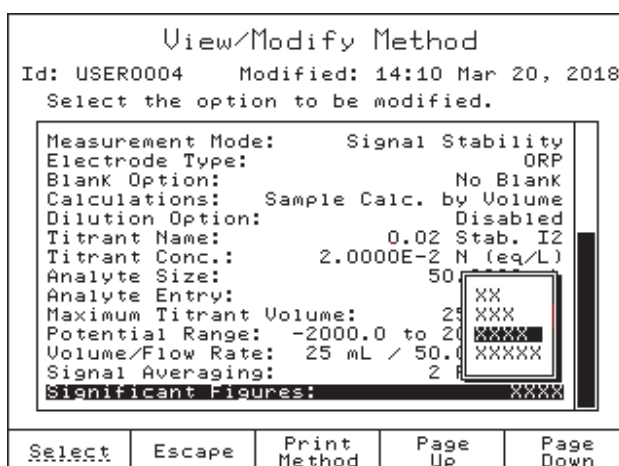

## 5.6 Printing

To print method parameters, press **Method Options** from the main screen.

Press **Print Method** and wait a few seconds until the printer completes the job.

If no printer is connected to the dedicated socket, or if the printer is offline, an error message will appear on the display (see **Connecting a Printer** section, for information about connecting a printer to the Titrator).

---

**Chapter 6. Contents**

**6 TITRATION MODE..... 6 - 3**

**6.1 Titration Start..... 6 - 3**

6.1.1 In Progress Titration ..... 6 - 3

6.1.2 Suspend Titration ..... 6 - 3

6.1.3 On-line Graph ..... 6 - 3

**6.2 Titration Stop ..... 6 - 5**





## 6 TITRATION MODE

### 6.1 Titration Start

Before beginning to perform a titration make sure that the following conditions are met:

- At least one pump is properly installed.
- A burette is inserted in the pump and filled with titrant.
- The aspiration tube is inserted in the titrant bottle and the dispensing tube is over the analyte beaker.
- The standard or sample has been carefully weighed / measured into the titration beaker.
- The electrode and the temperature probe is inserted in the analyte beaker.
- The desired method is selected as active and the parameters are set at optimum values.

#### 6.1.1 In Progress Titration

To start a new titration, press  from the main screen.

When a titration begins:

- The stirrer will turn on (if detected and enabled).
- If the pre-stirring time option is enabled, the sample will be stirred until the prescribed time elapses (see **Methods**, *Pre-Titration Stir Time* section).
- If the pre-titration volume option is enabled, the prescribed volume will be dispensed (see **Methods**, *Pre-Titration Volume* section).
- According to the *Measurement Mode* and the *Dosing Type* option, the titrator will start to deliver doses until the titration end point are detected or a titration stop condition occurs.

#### 6.1.2 Suspend Titration

While titration is in progress, you can temporarily stop it by pressing . All the titration parameters will be frozen.

You can continue the titration by pressing .

#### 6.1.3 On-line Graph

During a titration, both the potentiometric S-shape curve and the selected derivative curve (titration with equivalence point only) can be displayed on the **Titration Graph** screen, by pressing . The titration ID report is also displayed inside the graph window.

# TITRATION MODE

The S-shape curve and the derivative curve are scaled to fit simultaneously inside the display. Also, when the titration is normally terminated (end point detected successfully), the end point volume marked with a cross is displayed on the graph.

The contents of the graph as related to an end point type, is as follows:

*Equivalence End Point (pH)* - the pH curve and the selected derivative vs volume is displayed (see Figure 1).

*Equivalence End Point (mV)* - the mV curve and the selected derivative vs volume is displayed (see Figure 2).

*Fixed End Point (pH)* - only the pH vs volume curve is displayed (see Figure 3).

*Fixed End Point (mV)* - only the mV vs volume curve is displayed (see Figure 4).

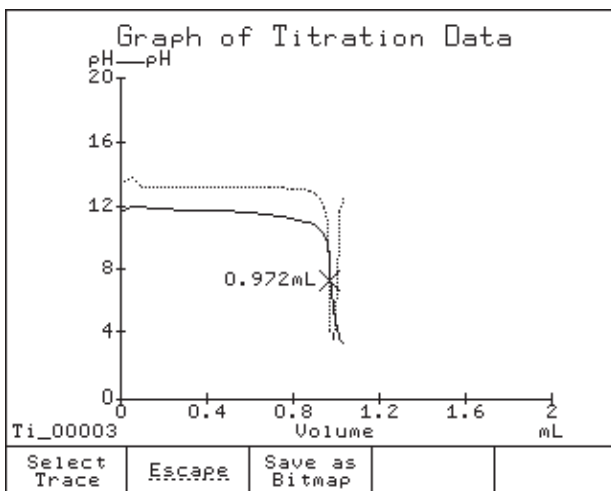

Figure 1

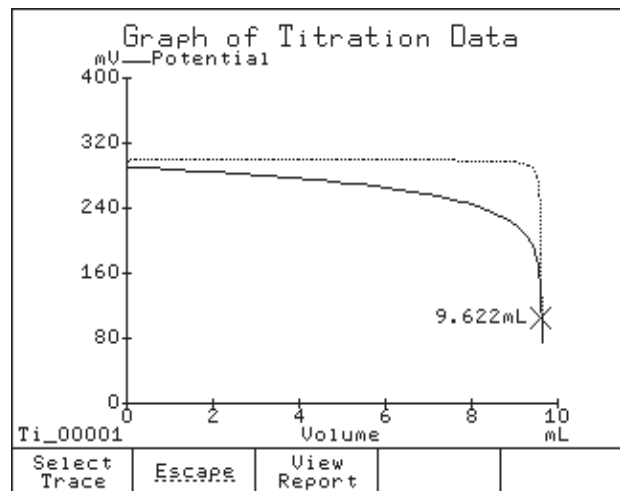

Figure 2

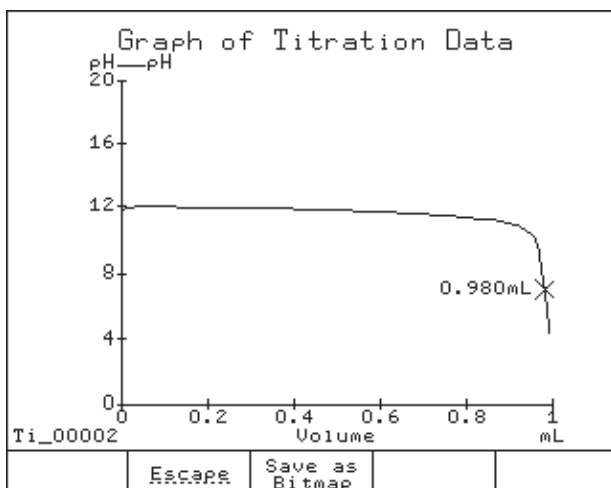

Figure 3

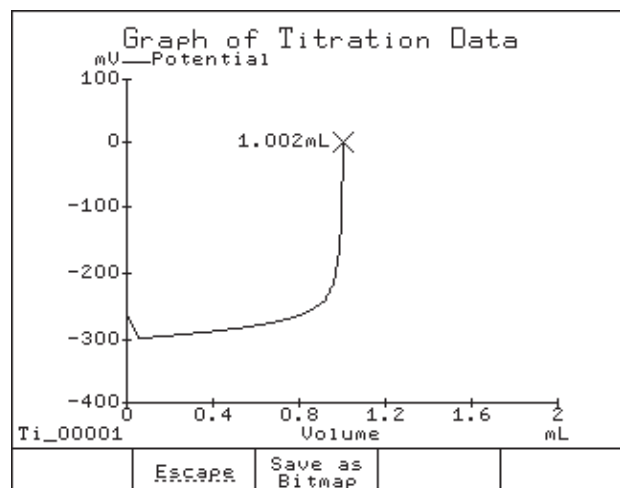

Figure 4

- Select Trace** - allows you to view on the ordinate axis a plot of either the mV (or pH) values or the selected derivative values (of mV or pH). Available only for titrations with equivalence end points.
- Save as Bitmap** - allows you to save the graph as a bitmap file. Available only when the titration is finished (after end point detection).

## 6.2 Titration Stop

The titration can be finished in one of the modes described below:

- **Titration Completed.** The titration was successfully terminated (with end point successfully detected). This is the only mode with valid final result values.
- **Manually Terminated.** The current titration was manually terminated before end point detection was achieved.
- **Limits Exceeded.** The preset maximum titrant volume was delivered without reaching the end point. The titration is stopped with an error message.
- **Critical Error.** A critical error occurred and the titration was stopped. These errors are normally related to the dosing system. The titration is stopped with a specific error message.
- **Potential Out of Range.** The measured values from the input sensor are outside the preset range (potential range). The titration is stopped with an error message.



---

## **Chapter 7. Contents**

- 7     pH Mode .....7 - 3**
- 7.1   Display .....7 - 4**
- 7.2   pH Setup .....7 - 5**
  - 7.2.1 Buffer Entry Type ..... 7 - 5
  - 7.2.2 First Calibration Point ..... 7 - 6
  - 7.2.3 Edit Custom Buffers..... 7 - 6
  - 7.2.4 Edit Buffer Group ..... 7 - 7
  - 7.2.5 Calibration Reminder ..... 7 - 8
  - 7.2.6 Set Reminder Period..... 7 - 8
  - 7.2.7 Clear Calibration ..... 7 - 9
  - 7.2.8 pH GLP Data ..... 7 - 9
  - 7.2.9 Logging Interval..... 7 - 10
  - 7.2.10 Stability Criteria ..... 7 - 10
  - 7.2.11 pH Resolution ..... 7 - 11
  - 7.2.12 Stirrer Configuration..... 7 - 11
  - 7.2.13 Stirring Speed ..... 7 - 12
- 7.3   pH Calibration .....7 -12**
- 7.4   Logging .....7 -15**
  - 7.4.1 Automatic Logging ..... 7 - 15
  - 7.4.2 Manual Logging ..... 7 - 15



## 7 pH MODE

By pressing Mode from the main screen, the Titrator can be switched to **Titrator**, **pH**, **mV** or **ISE** modes.

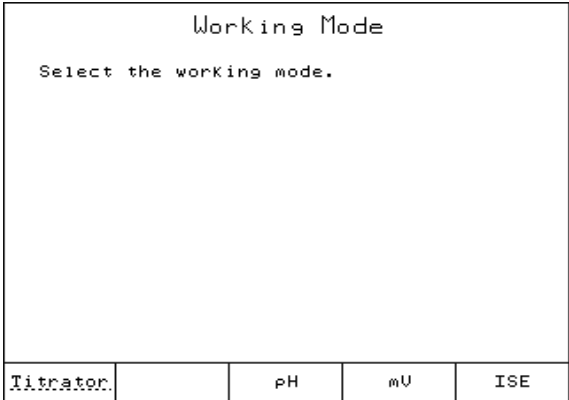

Titrator

Switches to **Titrator** mode.

pH

Switches to **pH** mode.

mV

Switches to **mV** mode.

ISE

Switches to **ISE** mode.

# pH MODE

## 7.1 Display

The **pH** screen is shown below with short explanations of the screen segments.

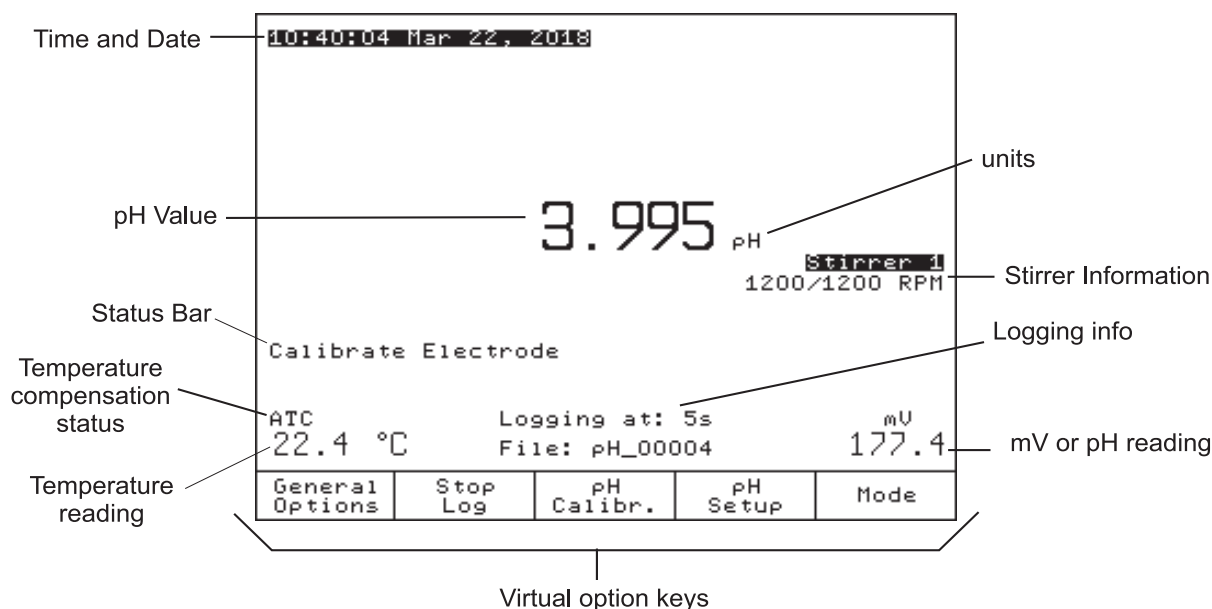

### pH Mode Option keys:

- General Options** The General Options screen gives access to options that are not directly related to the measurement process (see *General Options* chapter for more information).
- Save Reading** Stores the current pH reading (see *Manual Logging* section).
- or**
- Start Log** Starts the pH automatic log (see *Automatic Logging* section).
- pH Calibr.** Enter the pH calibration screen (see *pH Calibration* section).
- pH Setup** Enter the pH setup screen, parameters are associated with pH measurements and calibration (see *pH Setup* section).
- Mode** Allow the user to switch between the available measurement modes: **Titration**, **pH**, **mV** or **ISE** mode.



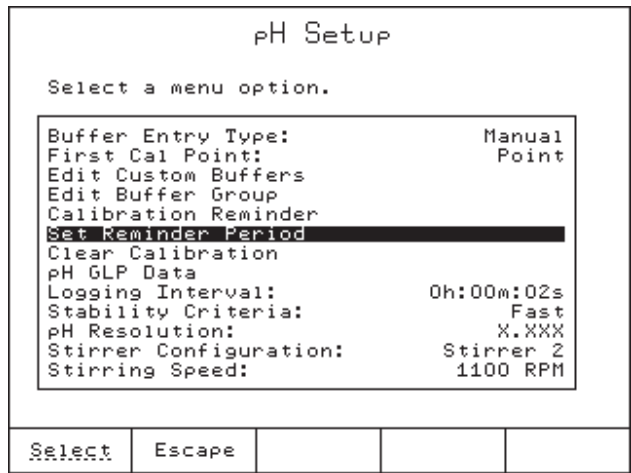

## 7.2 pH Setup

To access pH Setup, press  option key while in pH mode.



Use  and  keys to highlight the desired option.

Press  or  to access the selected option.

### 7.2.1 Buffer Entry Type

Select the pH buffer entry mode used for calibration:

**Automatic** - the instrument automatically selects the pH calibration point as the closest buffer from the predefined Buffer Group (see *Edit Buffer Group* section).

**Semiautomatic** - the instrument automatically selects the closest buffer from Available Buffers (standard and custom buffers).

**Manual** - the calibration buffer must be manually selected by the user during calibration from the available buffer list (standard and custom buffers).

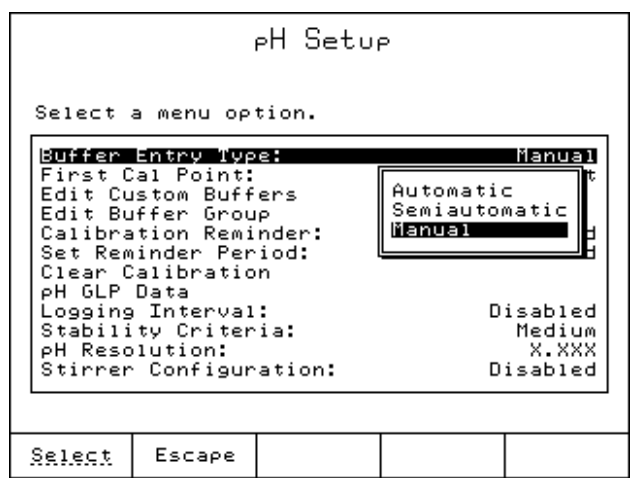

# pH MODE

## 7.2.2 First Calibration Point

Two options are available for the First Calibration Point: *Point* and *Offset*.

If *Point* option is selected, the slope values adjacent to the calibration points will be reevaluated (normal calibration).

If at least a two-point calibration has been performed and an offset correction is needed, perform a one-point calibration using the *Offset* option. The existing slope values will not be changed.

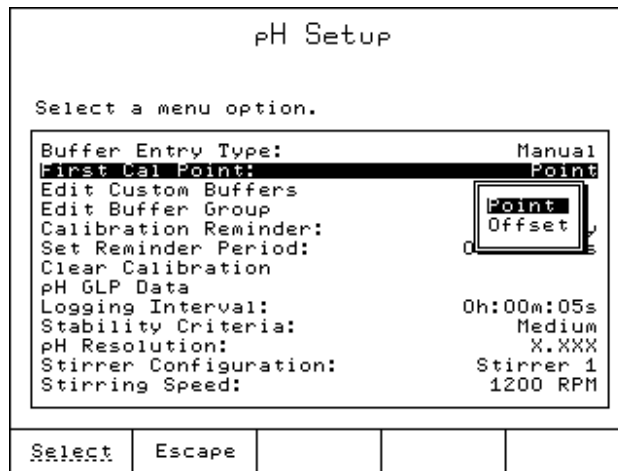

## 7.2.3 Edit Custom Buffers

If you wish to use buffers other than the standard ones, the Edit Custom Buffers option is available, allowing you to set the desired pH buffers. Up to five pH custom buffers can be set.

**Note:** Custom buffers are not temperature compensated. The value of the buffer at the calibration temperature should be entered. The standard buffers are automatically temperature compensated.

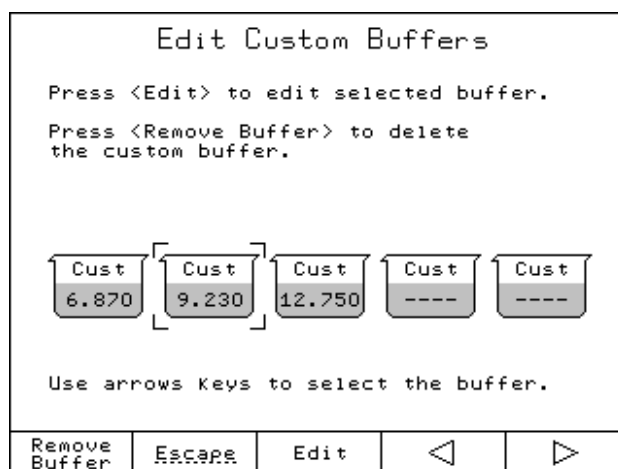

- Use ◀ and ▶ keys to select the desired buffer.
- Press  to delete the custom buffer.
- Press  to edit the selected buffer; use the numeric keys to edit the buffer values.
- Press  to save the value.
- Press  to return to pH Setup menu.

### 7.2.4 Edit Buffer Group

Select up to five buffers from the available buffers (Hanna or Custom) to be used for automatic buffer recognition (Automatic Buffer Entry Type).

Within the Buffer Group, pH values must be at least 1.5 pH far apart.

If the Buffer Group already contains five pH buffers, at least one pH buffer has to be removed in order to add another buffer.

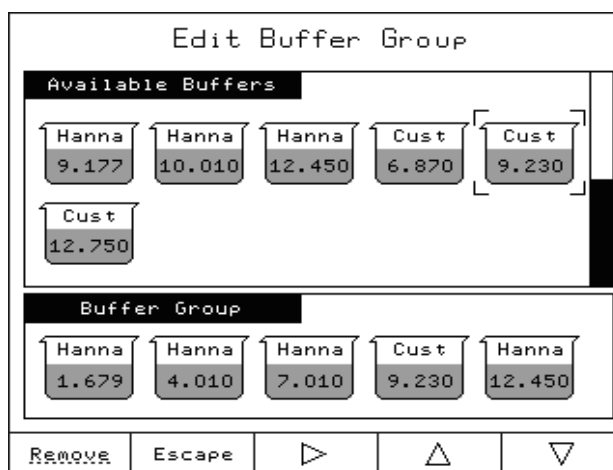

- Use the arrow keys to select the pH buffer to be included/removed in/from the buffer group.
- Press  or  to add/remove the selected pH Buffer to/from buffer group.
- Press  to return to pH Setup menu.

# pH MODE

## 7.2.5 Calibration reminder

In order to have accurate readings, the electrode must be calibrated frequently. Three options are available for calibration reminder:

- Daily* - the calibration reminder will appear daily at specified time.
- Periodic* - the calibration reminder will appear after the set time has elapsed since the last calibration.
- Disabled* - the calibration reminder will not appear.

Calibration Reminder							
Select a menu option.							
<table border="1"><tr><td>Daily</td></tr><tr><td>Periodic</td></tr><tr><td>Disabled</td></tr></table>					Daily	Periodic	Disabled
Daily							
Periodic							
Disabled							
Select	Escape						

## 7.2.6 Set Reminder Period

If *Daily* or *Periodic* option was selected for the Calibration Reminder, the reminder period must also be set.

For a daily reminder period, the time of day can be set.

For a periodic reminder period, the number of days, hours and minutes can be set.

Periodic Calibration Reminder				
Enter the time period that must be passed since the last calibration,whereafter the calibration reminder appears.				
10                    2                    30				
days                    hours                    minutes				
Press Next to move to the next entry.				
Accept	Escape	Delete Digit	Next	Off

- Press  to move the cursor to the next field.
- Press  to save the changes or  to return to the previous screen.
- Press  to disable the calibration reminder and return to pH setup.

### 7.2.7 Clear Calibration

This option clears the existing pH calibration for the selected channel. If the calibration is cleared, another calibration has to be performed.

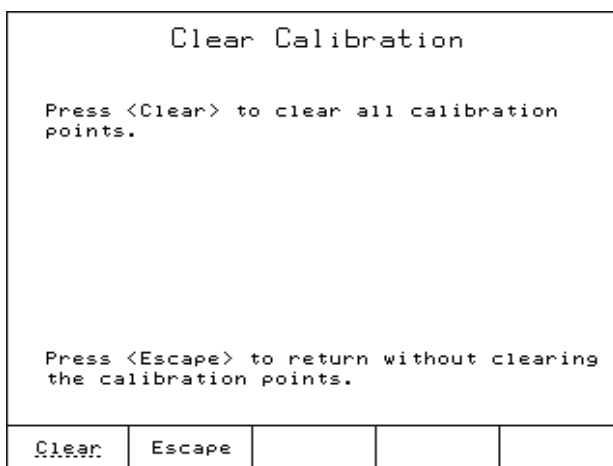

- Press  to clear the previous calibration or  to return to the previous screen without clearing the calibration.

### 7.2.8 pH GLP Data

Displays the pH calibration data.

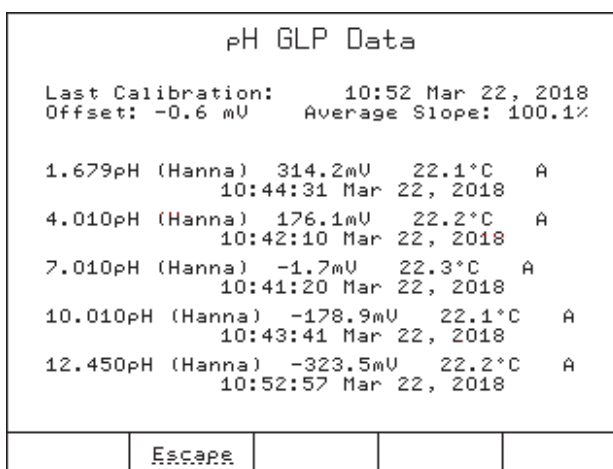

# pH MODE

## 7.2.9 Logging Interval

Set the logging interval to be used for automatic logging.

Logging Interval				
Enter the data logging interval.				
0	0	2		
hours	minutes	seconds		
Press Next to move to the next entry.				
Accept	Escape	Delete Digit	Next	Off

## 7.2.10 Stability Criteria

Select the signal stability criteria:

- Fast* - quicker results with less accuracy
- Medium* - medium speed results with medium accuracy
- Accurate* - slower results with high accuracy

pH Setup				
Select a menu option.				
Buffer Entry Type:	Manual			
First Cal Point:	Point			
Edit Custom Buffers				
Edit Buffer Group				
Calibration Reminder:				
Set Reminder Period:				
Clear Calibration				
pH GLP Data				
Logging Interval:				
Stability Criteria:	Medium			
pH Resolution:	X.XXX			
Stirrer Configuration:	Stirrer 1			
Stirring Speed:	1200 RPM			
Select	Escape			

### 7.2.11 pH Resolution

Set the desired pH resolution: one (X.X), two (X.XX) or three (X.XXX) decimal places.

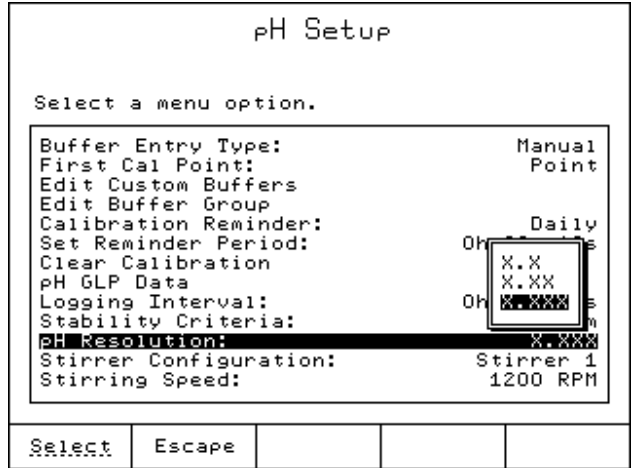

### 7.2.12 Stirrer Configuration

Set the stirrer configuration: Stirrer 1, Stirrer 2, or Disabled.

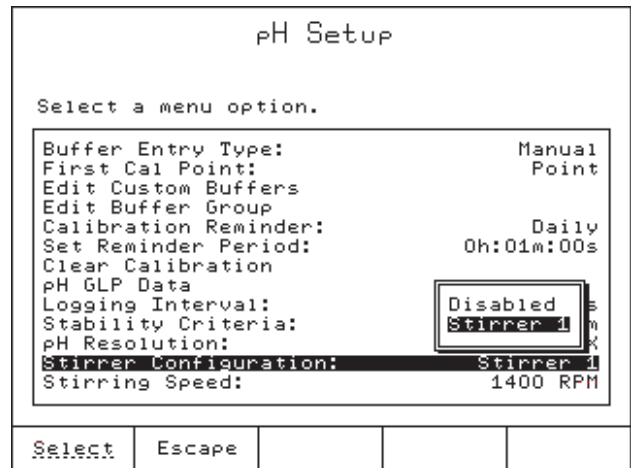

## pH MODE

### 7.2.13 Stirring Speed

The stirring speed for the selected stirrer can be set.

Stirring Speed				
Enter the speed of the stirrer within below range.				
1100 RPM				
The range is from 0 to 2500 RPM.				
Accept	Escape	Delete Digit		

### 7.3 pH Calibration

Calibrate the instrument often, especially if high accuracy is required. The instrument should be recalibrated:

- Whenever the pH electrode is replaced.
- At least once a week.
- After testing aggressive chemicals.
- When "No pH Calibration" or "pH Calibration Expired" message appears on the LCD, in the Reminder messages area.

pH Calibration				
7.022 pH				
ATC 22.1 °C	Hanna 7.010		mV -1.9	
Calibrated Buffers				
Hanna 1.679	Hanna 4.010	Hanna 7.010	Hanna 10.010	Hanna 12.450
Last Calibration: 10:52 Mar 22, 2018				
Press <Accept> to update calibration.				
Accept	Escape	Edit	Next Buffer	Previous Buffer



### PREPARATION

Pour small quantities of the buffer solutions into clean beakers. If possible, use plastic beakers to minimize any EMC interferences.

For accurate calibration and to minimize cross-contamination, use two beakers for each buffer solution: one for rinsing the electrode and one for calibration. If you are measuring in the acidic range, use pH 7.01 or 6.86 as the first buffer and pH 4.01/3.00 or 1.68 as the second buffer. If you are measuring in the alkaline range, use pH 7.01 or 6.86 as the first buffer and pH 10.01/9.18 or 12.45 as the second buffer.

For extended range measurements (acidic and alkaline), perform a five-point calibration by selecting five buffers across the entire pH range.

### CALIBRATION PROCEDURE

During calibration, the user has a choice of 8 standard buffers: pH 1.68, 3.00, 4.01, 6.86, 7.01, 9.18, 10.01, 12.45 and up to 5 custom buffers.

For accurate measurements it is recommended to perform a five-point calibration. However, at least a two-point calibration is suggested. For pH titrations, the selected buffers should bracket your end point (e.g.: if your end point value is at 8.5, use 7.01 and 9.18 for calibration).

Three buffer entry types are available: Automatic, Semiautomatic and Manual Selection (see *Buffer Entry Type* section).

To begin calibration:

- Press  . If the instrument was calibrated before and the calibration was not cleared, the old calibration can be cleared by pressing  .

**Note:** *It is very important to clear calibration history when a new electrode is used.*

- Immerse the pH electrode and the temperature probe approximately 4 cm (1.5") into a buffer solution and stir gently. The temperature probe should be close to the pH electrode.
- Select the pH calibration buffer value with  or  .
- Press  to update the calibration. Once the reading has stabilized, the calibration buffer will be added to the Calibrated Buffers section.
- Rinse the pH electrode and the temperature probe, then immerse them into the next buffer solution and follow the above procedure or press  to exit the calibration.

**Notes:** • *The new calibration points will replace old ones if the difference between them is  $\pm 0.2$  pH. Buffers used in older calibrations will not have a solid background.*

- *If calibrating with a standard buffer in MTC mode, the pH value and temperature can be modified by pressing  . The values can be adjusted using the numeric keys. Press  to save the new values.*

## pH MODE

Manual Edit				
Edit pH buffer and manual temperature.				
Buffer: <span style="background-color: black; color: black;">████████</span> 7.005 pH				
Temperature: 25.0 °C				
Low limit: 6.990 pH				
High limit: 7.030 pH				
Press Next to move to the next entry.				
Accept	Escape	Delete Digit	Next	

- In ATC mode, the pH value can be modified by pressing Edit.
- If the Automatic buffer entry type was selected for the calibration procedure, the instrument will automatically select the closest buffer to the measured pH value from the edit buffer group (see Buffer Group Edit section).
- If the Semiautomatic buffer entry type was selected for the calibration procedure, the instrument will automatically select the closest buffers to the measured pH value from all the available buffers and the buffer value can be selected with Previous Buffer or Next Buffer.







### CALIBRATION MESSAGES:

- **Wrong Buffer. Please check the buffer:** This message appears when the difference between the pH reading and the value of the selected calibration buffer is significant. If the message is displayed, check if you have selected the appropriate calibration buffer.
- **Wrong buffer temperature:** This message appears if the buffer temperature is out of the defined temperature range.
- **Clean the electrode or check the buffer. Press Accept to update calibration:** This message alerts the user that some dirt or deposits could be on the electrode.
- **Slope too low. Please check the buffer:** This message appears if the current slope is under 80% or over 110% of default slope. Recalibrate the instrument using fresh buffers.
- **Slope too high. Press Clear Cal to clear the old calibration:** This message appears as a result of an erroneous slope condition. Follow displayed instructions.

## **7.4 Logging**

Data logging is available in pH mode. It can be logging on demand (Manual Logging) or automatically at predefined time intervals (Automatic Logging).

To customize the logging report:

- Press  to display the **Data Parameters** screen.
- Highlight the *Setup pH/mV/ISE Report* option and press  to display the **Setup pH/mV/ISE Report** screen.
- Use the  and  keys to highlight the data field that you want to show/hide in the pH/mV/ISE report and then press  to activate/deactivate it.
- Each field marked by "\*" is an active field selected for the report.
- Press  to save the customized report.

### **7.4.1 Automatic Logging**

The logging interval is set in the pH / mV / ISE Setup screen.

Press  to start the log.

The logging interval and name of logging file will be also displayed on the measure screen.

To stop the automatic logging, press  again.

### **7.4.2 Manual Logging**

To manually log pH readings, press  from the **pH** screen.

A new record will be added to the report every time  is pressed.



---

# Chapter 8. Contents

- 8 mV ..... 8 - 3**
- 8.1 Display ..... 8 - 4**
- 8.2 mV Setup..... 8 - 4**
  - 8.2.1 Clear Relative mV Offset..... 8 - 5
  - 8.2.2 Logging Interval ..... 8 - 5
  - 8.2.3 Stability Criteria ..... 8 - 6
  - 8.2.4 Stirrer Configuration ..... 8 - 6
  - 8.2.5 Stirring Speed ..... 8 - 7
- 8.3 Relative mV Calibration ..... 8 - 7**
- 8.4 Logging ..... 8 - 8**
  - 8.4.1 Automatic Logging ..... 8 - 8
  - 8.4.2 Manual Logging ..... 8 - 8



**8 mV**

By pressing Mode from the main screen, the Titrator can be switched to **Titrator, pH, mV** or **ISE** modes.

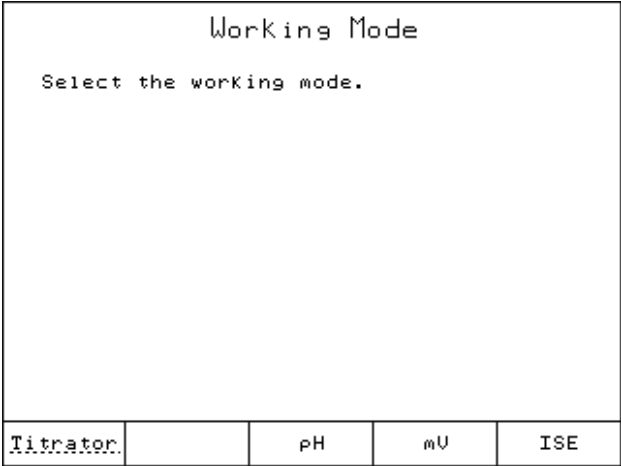

Titrator

Switches to **Titrator** mode.

pH

Switches to **pH** mode.

mV

Switches to **mV** mode.

ISE

Switches to **ISE** mode.

# mV MODE

## 8.1 Display

The **mV** screen is shown below.

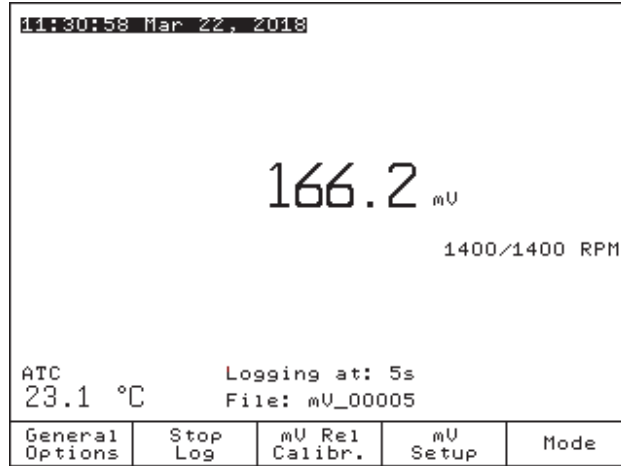

**mV Mode Option Keys:**

General Option

The General Options screen gives you access to options that are not directly related to the measurement process (See **General Options** chapter for more information).

Save Reading

Stores the current mV reading (see *Manual Logging* section).

or

Start Log

Starts the mV automatic log (see *Automatic Logging* section).

mV Rel Calibr.

Enter the relative mV calibration screen (see *Relative mV Calibration* section).

mV Setup

Enter the mV setup screen. Parameters are associated with mV measurement and calibration.

Mode

Allows the user to switch between the available measurement modes: Titrator, pH, mV or ISE mode.

## 8.2 mV Setup

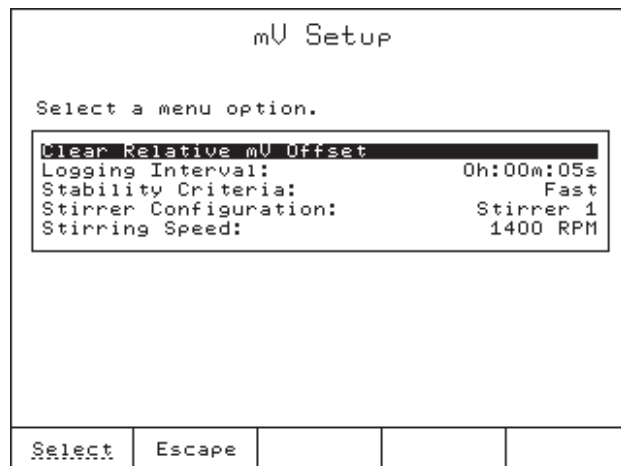



### 8.2.1 Clear Relative mV Offset

Clear the relative mV offset and return to absolute mV measurement.

- Press Clear to clear the relative mV offset or Escape to return to the previous screen.

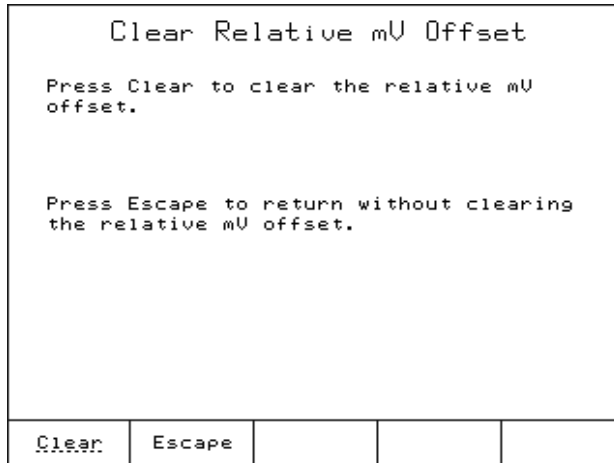

### 8.2.2 Logging Interval

Set the logging interval.

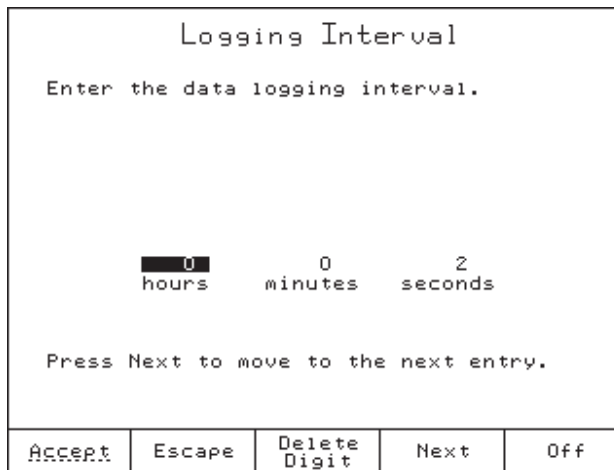

# mV MODE

## 8.2.3 Stability Criteria

Select the signal stability criteria:

- Fast* - quicker results with less accuracy
- Medium* - medium speed results with medium accuracy
- Accurate* - slower results with high accuracy

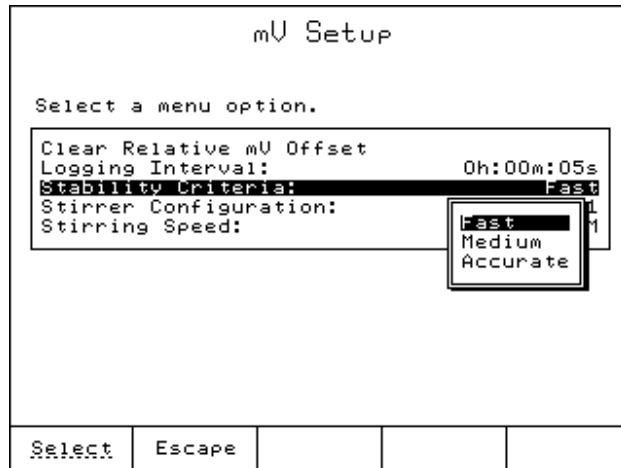

## 8.2.4 Stirrer Configuration

Set the stirrer configuration: Stirrer 1, Stirrer 2 or Disabled.

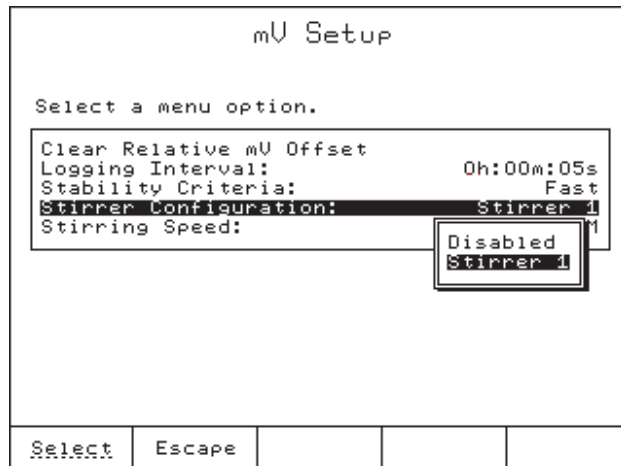

### 8.2.5 Stirring Speed

The stirring speed for the selected stirrer can be set.

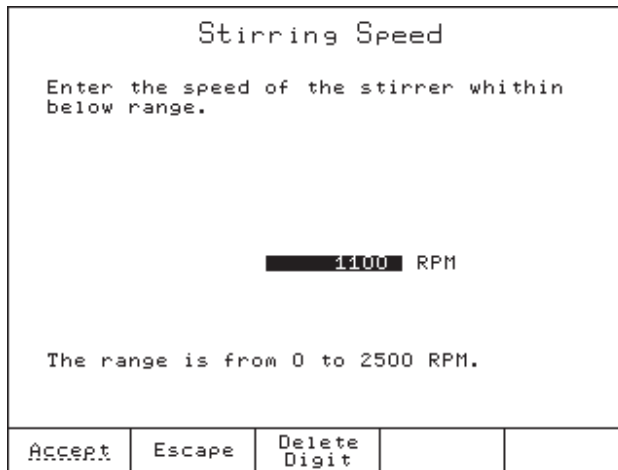

### 8.3 Relative mV Calibration

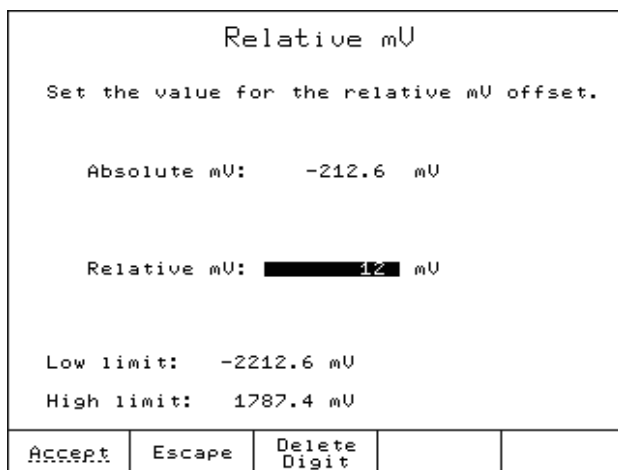

- Press  to accept the value.
- Press  to delete the last digit.
- Press  to cancel this operation and return to the previous screen.







## mV MODE

---

### 8.4 Logging

Data logging is available in mV mode. It can be logging on demand (Manual Logging) or automatically at predefined time intervals (Automatic Logging).

To customize the logging report:

- Press  to display the **Data Parameters** screen.
- Highlight the *Setup pH/mV/ISE Report* option and press  to display the **Setup pH/mV/ISE Report** screen.
- Use the  and  keys to highlight the data field that you want to show/hide in the pH/mV/ISE report and then press  to activate/deactivate it.
- Each field marked by "\*" is an active field selected for the report.
- Press  to save the customized report.

#### 8.4.1 Automatic Logging

The logging interval is set in the mV Setup screen.

Press  to start the log.

The logging interval and name of logging file will be also displayed on the measure screen.

To stop the automatic logging, press  again.

#### 8.4.2 Manual Logging

To manually log mV readings, press  from the **mV** screen.

A new record will be added to the report every time  is pressed.

## Chapter 9. Contents

<b>9</b>	<b>ISE Mode .....</b>	<b>9 - 3</b>
<b>9.1</b>	<b>Display .....</b>	<b>9 - 4</b>
<b>9.2</b>	<b>ISE Setup .....</b>	<b>9 - 5</b>
9.2.1	Calibration Group .....	9 - 5
9.2.2	Temperature Compensation .....	9 - 6
9.2.3	Isopotential Point .....	9 - 6
9.2.4	Edit Custom Standards .....	9 - 7
9.2.5	Edit Standard Group .....	9 - 7
9.2.6	Calibration Reminder .....	9 - 8
9.2.7	Set Reminder Period .....	9 - 8
9.2.8	Clear Calibration .....	9 - 9
9.2.9	ISE GLP Data .....	9 - 9
9.2.10	Electrode Type .....	9 - 10
9.2.11	Concentration Unit .....	9 - 11
9.2.12	Logging Interval .....	9 - 11
9.2.13	Stability Criteria .....	9 - 12
9.2.14	ISE Significant Digits .....	9 - 12
9.2.15	Stirrer Configuration .....	9 - 13
9.2.16	Stirring Speed .....	9 - 13
<b>9.3</b>	<b>ISE Calibration .....</b>	<b>9 - 13</b>
<b>9.4</b>	<b>Logging .....</b>	<b>9 - 15</b>
9.4.1	Automatic Logging .....	9 - 15
9.4.2	Manual Logging .....	9 - 15



**9 ISE Mode**

By pressing **Mode** from the main screen, the Titrator can be switched to **Titrator, pH, mV** or **ISE** modes.

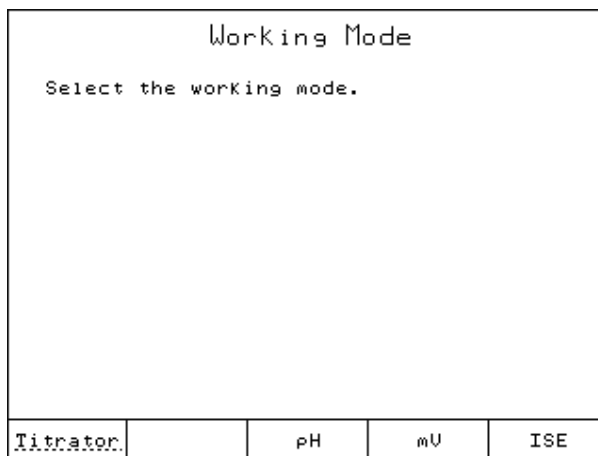

Titrator

Switches to **Titrator** mode.

pH

Switches to **pH** mode.

mV

Switches to **mV** mode.

ISE

Switches to **ISE** mode.

# ISE MODE

## 9.1 Display

The **ISE** screen is shown below.

11:38:42 Mar 22, 2018				
10.6 ppm				
ISE: Silver				
Temp.	Logging at: 5s	mV		
22.8 °C	File: ISE00006	224.5		
General Options	Stop Log	ISE Calibr.	ISE Setup	Mode

ISE Mode option keys:

- The General Options screen gives access to options that are not directly related to the measurement process (see **General Options** chapter for more information).
- Stores the current concentration reading (see *Manual Logging* section).
- or
- Starts the ISE automatic log (see *Automatic Logging* section).
- Enter the ISE calibration screen (see *ISE Calibration* section).
- Enter the ISE setup screen. Parameters are associated with ISE measurements and calibration.
- Allows the user to switch between the available measurement modes: Titrator, pH, mV and ISE mode.



## 9.2 ISE Setup

To access the ISE Setup, press  option key in ISE mode.

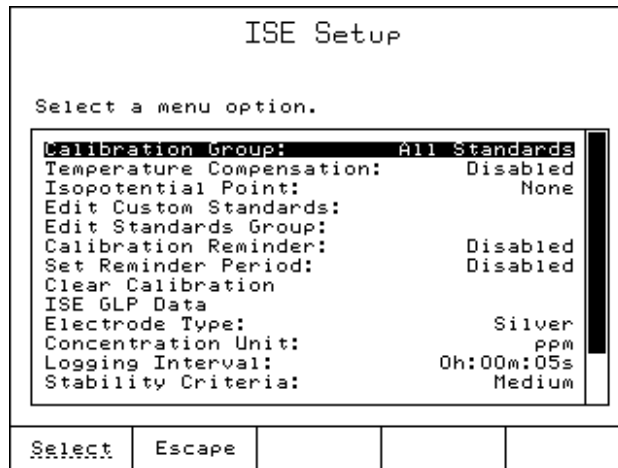

### 9.2.1 Calibration Group

Selecting the set of available standards to be used in calibration:

**All Standards:** the set of available standards includes the Standard solutions and Custom solutions.

**Standards Group:** the set of available standards includes the standards selected by the user.

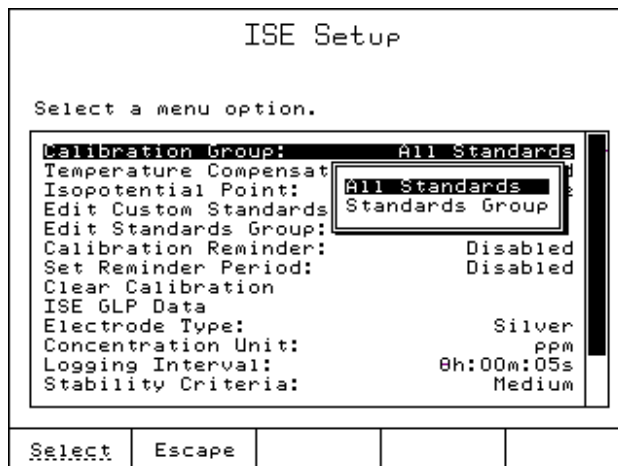

# ISE MODE

## 9.2.2 Temperature Compensation

Enable or disable temperature compensation for ISE measurements.

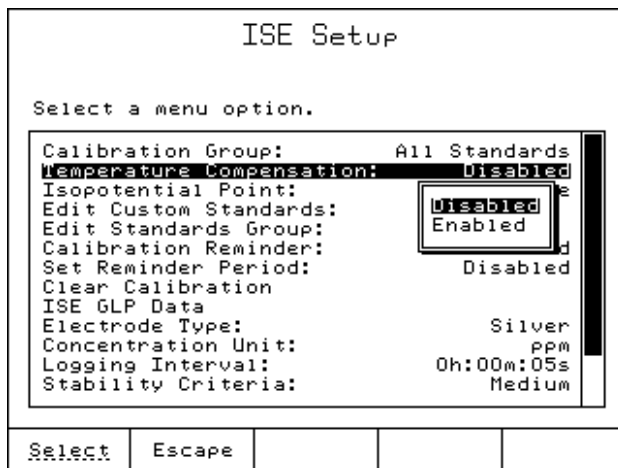

**Note:** If you enabled Temperature Compensation, then the isopotential point must be set.

## 9.2.3 Isopotential Point

This option is available only if temperature compensation is enabled.

This option allows the user to set an isopotential point for the selected electrode. Ion selective electrodes have different isopotential points. The isopotential point is edited in ppm units only. The isopotential point should be entered if it is known and if measurements are going to be made at several temperatures.

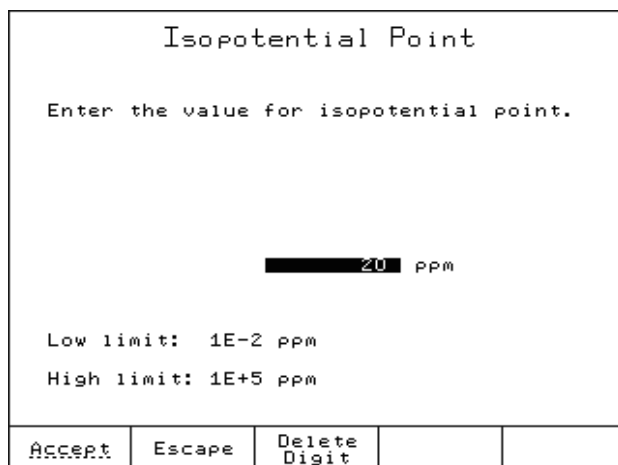

### 9.2.4 Edit Custom Standards

Edit the custom standard list. Up to five can be used in calibration.

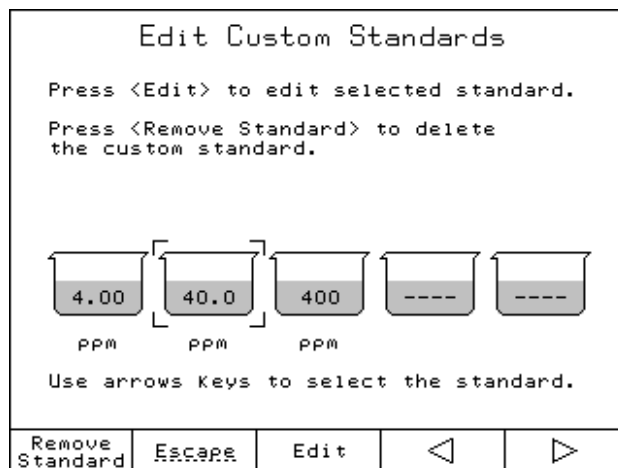

- Use the ◀ and ▶ keys to select the standard.
- Press  to delete the custom standard.
- Press  to edit the selected custom standard; use the numeric keys to edit the standard.

### 9.2.5 Edit Standard Group

Select up to 5 standards from the available standards (Predefined and Custom) to be used during calibration.

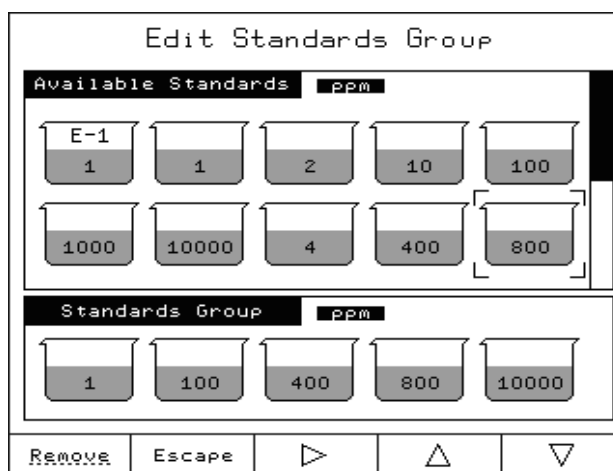

- Use the arrow keys to select the standard to be included/removed in/from the standard group.
- Press  or  to add/remove the selected standard to/from standard Group.
- Press  to return to ISE Setup menu.

# ISE MODE

## 9.2.6 Calibration Reminder

In order to have accurate readings, the electrode must be calibrated frequently. Three options are available for the calibration reminder:

Calibration Reminder							
Select a menu option.							
<table border="1"><tr><td>Daily</td></tr><tr><td>Periodic</td></tr><tr><td>Disabled</td></tr></table>					Daily	Periodic	Disabled
Daily							
Periodic							
Disabled							
Select	Escape						

- Daily* - the calibration reminder will appear daily at specified time.
- Periodic* - the calibration reminder will appear after the set time has elapsed since the last calibration.
- Disable* - the calibration reminder will not appear.

## 9.2.7 Set Reminder Period

If Daily or Periodic option was selected for the Calibration Reminder, the reminder period must also be set.

For a daily reminder period the time of day can be set.

For a periodic reminder period the number of days, hours and minutes can be set.

- Press  to move the cursor to the next field.
- Press  to save the changes or  to return to the previous screen.
- Press  to disable the calibration reminder and return to ISE setup menu.

Periodic Calibration Reminder				
Enter the time period that must be passed since the last calibration,whereafter the calibration reminder appears.				
10                      2 <b>30</b>				
days                      hours                      minutes				
Press Next to move to the next entry.				
Accept	Escape	Delete Digit	Next	Off

### 9.2.8 Clear Calibration

This option clears the existing ISE calibration. If the calibration is cleared, a new calibration must be done in order to take measurements.

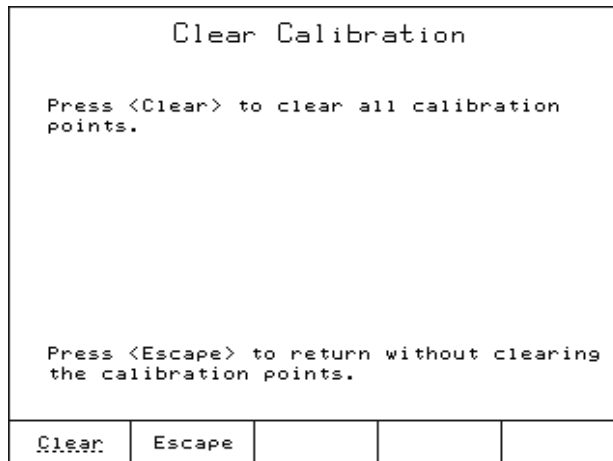

- Press  to clear the previous calibration or  to return to the previous screen.

### 9.2.9 ISE GLP Data

Displays the ISE calibration data.

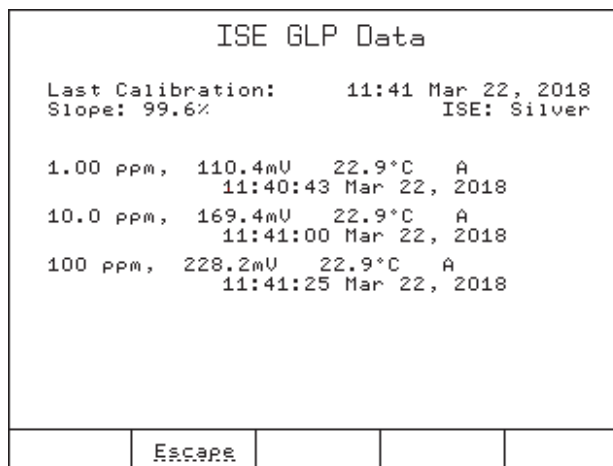

## ISE MODE

### 9.2.10 Electrode Type

Select the Ion Selective Electrode used for measurements from a list: Ammonia, Bromide, Cadmium, Calcium, Carbon Dioxide, Chloride, Cupric, Cyanide, Fluoride, Iodide, Lead, Nitrate, Potassium, Silver, Sodium, Sulfate, Sulfide or five custom ISE. For the standard ISE, it is possible to view the Ion constants (Name, Molar Weight and Electric Charge/Slope), while for the custom ISE, all of these constants must be manually set.

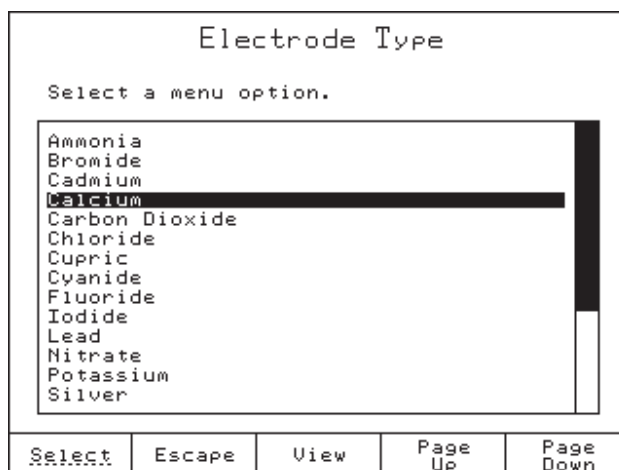

For Standard ISE:

- Press **View** to see the Ion constants, press **Escape** at any time to exit Ion constants view.

For Custom ISE:

- Press **View** to edit the Ion constants for the selected custom ISE. Use the  $\triangle$  and  $\nabla$  keys to select the desired Ion constant and press **Select** to edit the value or **Escape** to cancel operation.
- Set the Ion Name (up to 10 characters can be entered).
- Set the appropriate molecular weight (in g / mol) using the numeric keys. Press **Accept** to save the value or press **Escape** to return to the previous screen.
- Select the appropriate Electric Charge / Slope. Use the  $\triangle$  and  $\nabla$  keys to select the value and then press **Select**. If the Ion electric charge is None, its slope can be manually set by pressing **Edit**. Press **Accept** to save the value or press **Escape** to return to the previous screen.

### 9.2.11 Concentration Unit

Select the desired concentration unit for the measured Ion or chemical compound. The available concentration units are: ppt (g/L), ppm (mg/L), ppb ( $\mu\text{g/L}$ ), mg/mL, M (mol/L), mmol/L, %w/v or user defined.

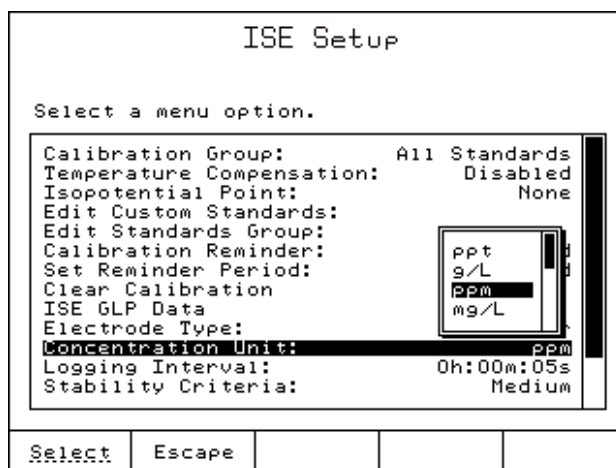

### 9.2.12 Logging Interval

Set the logging interval to be used.

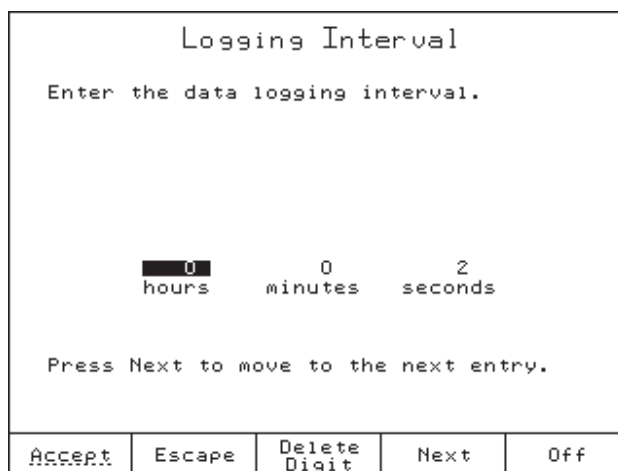

# ISE MODE

## 9.2.13 Stability Criteria

This option allows the user to select the signal stability criteria for the measured parameters:

- Fast* - quicker results with less accuracy
- Medium* - medium speed results with medium accuracy
- Accurate* - slower results with high accuracy

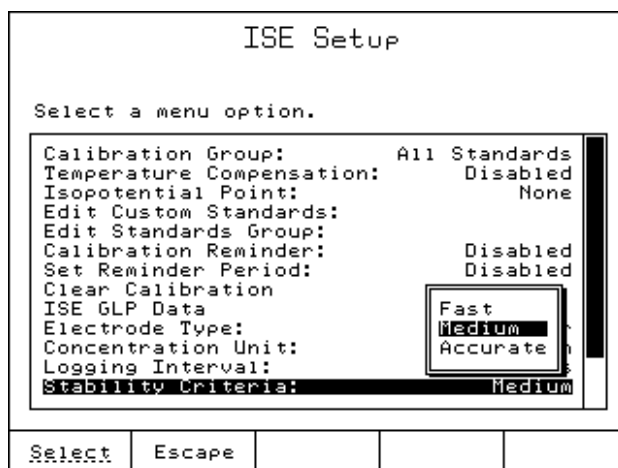

## 9.2.14 ISE Significant Digits

Select the number of significant digits to be displayed: one (X), two(XX) or three(XXX).

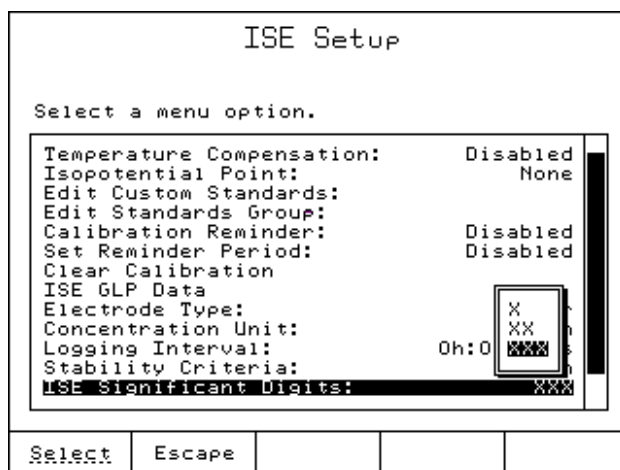



### 9.2.15 Stirrer Configuration

Set the stirrer configuration: Stirrer 1, Stirrer 2 (when available) or Disabled.

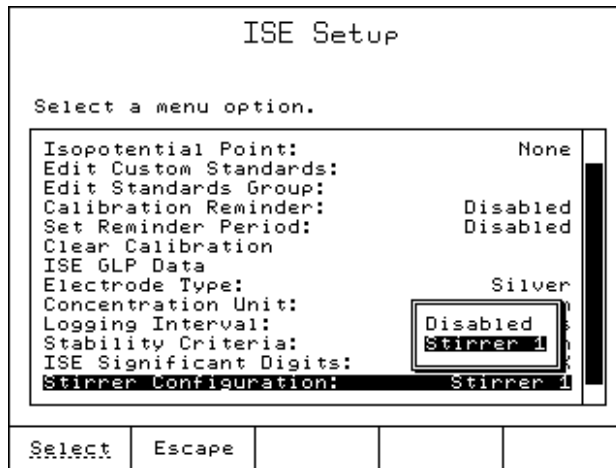

### 9.2.16 Stirring Speed

The stirring speed for the selected stirrer can be set.

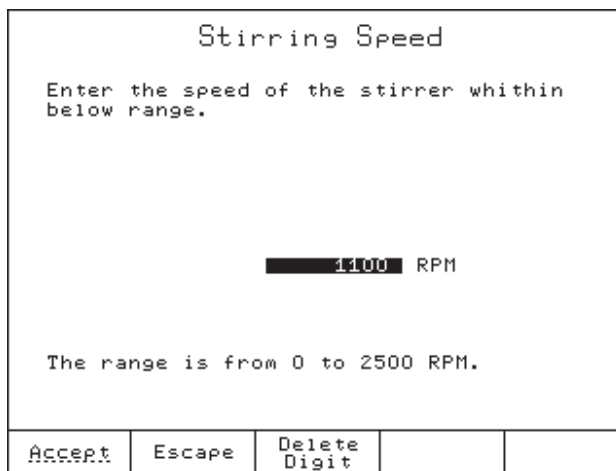

## 9.3 ISE Calibration

It is recommended to calibrate the instruments frequently if high accuracy is required. The instrument should also be recalibrated whenever the "Calibrate Electrode" message appears on the LCD.

Due to electrode conditioning time, the electrode must be immersed for several seconds to stabilize. The user will be guided step by step during calibration with easy-to-follow messages on the display. This will make the calibration a simple and error-free procedure.

#### PREPARATION:

Pour small quantities of the standard solution into clean beakers. If possible, use plastic beakers to minimize any EMC interferences.

## ISE MODE

For accurate calibration and to minimize cross-contamination, use two beakers for each standard solution: one for rinsing the electrode and one for calibration.

**Note:** For accurate measurements, add the appropriate ISA (Ionic Strength Adjustment) to the calibration standards.

### CALIBRATION PROCEDURE:

Before calibrating, make sure that the appropriate Electrode Type and concentration unit has been selected in ISE Setup.

Up to a five points calibration is possible using any combination of five memorized standard solutions and five custom solutions.

The ISE calibration and measurement can be performed with or without temperature compensation. If the temperature compensation option is enabled, the isopotential point of the electrode must be set in ISE Setup.

The current standard will be manually selected by the user from the available standards list. The list of available standards depends of the Manual Entry setting.

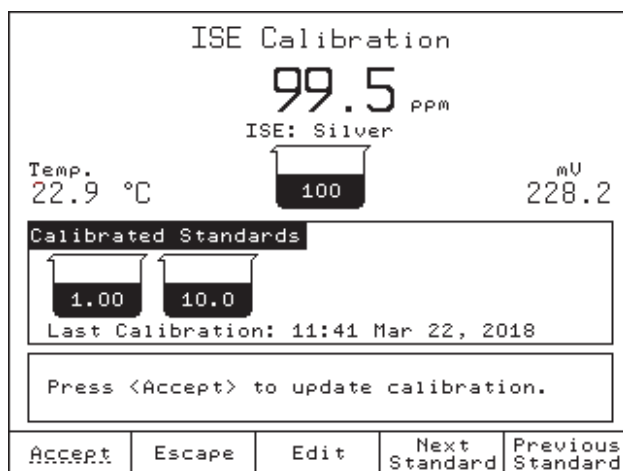







To calibrate the instrument using Manual Entry:

- Press **ISE Calibr.** from the main screen. If the instrument was calibrated before and the calibration was not cleared, the old calibration can be cleared by pressing **Clear Cal**.
- Immerse the Ion Selective Electrode and the temperature probe approximately 2 cm into the lowest concentrated standard solution.
- Select the concentration with **Next Standard** or **Previous Standard**.
- When the reading has stabilized, press **Accept** to update the calibration. The calibration point value will be added to the Calibrated Standard list.
- Select **Next Standard** and repeat the procedure with all of the available standards.

## 9.4 Logging

Data logging is available in ISE mode. It can be logging on demand (Manual Logging) or automatically at predefined time intervals (Automatic Logging).

To customize the logging report:

- Press  to display the **Data Parameters** screen.
- Highlight the *Setup pH/mV/ISE Report* option and press  to display the **Setup pH/mV/ISE Report** screen.
- Use the  and  keys to highlight the data field that you want to show/hide in the pH/mV/ISE report and then press  to activate/deactivate it.
- Each field marked by "\*" is an active field selected for the report.
- Press  to save the customized report.

### 9.4.1 Automatic Logging

The logging interval is set in the ISE Setup screen.

Press  to start the log.

The logging interval and name of logging file will be also displayed on the measure screen.

To stop the automatic logging, press  again.

### 9.4.2 Manual Logging

To manually log ISE readings, press  from the **ISE** screen.

A new record will be added to the report every time  is pressed.



## **Chapter 10. Contents**

<b>10</b>	<b>AUXILIARY FUNCTIONS .....</b>	<b>10-3</b>
<b>10.1</b>	<b>Burette .....</b>	<b>10-3</b>
10.1.1	Prime Burette .....	10-4
10.1.2	Rinse Tip .....	10-5
10.1.3	Manual Dispense .....	10-5
10.1.4	Purge Burette .....	10-5
<b>10.2</b>	<b>Stirrer .....</b>	<b>10-6</b>
<b>10.3</b>	<b>Results .....</b>	<b>10-6</b>
10.3.1	Review Last Analysis Report .....	10-7
10.3.2	Review Available Reports .....	10-8
10.3.3	GLP Data .....	10-8
10.3.4	Meter Information .....	10-9
10.3.5	Setup pH/mV/ISE Report .....	10-10
10.3.6	Setup Titration Report .....	10-10



## 10 AUXILIARY FUNCTIONS

### 10.1 Burette

To access the **Burette** screen, press Burette from the main titration screen. Highlight the desired option and then press Select.

Burette				
Select a menu option.				
<div style="border: 1px solid black; padding: 2px;"><p>Prime Burette Rinse Tip Manual Dispense Purge Burette</p></div>				
The current pump is: Pump 1 Current burette volume is 25 mL.				
Select	Escape	Choose Pump		

Choose Pump allows you to select the desired pump for burette operations (it is only active if two pumps are connected).

Pump Setting				
Select the current pump.				
<div style="border: 1px solid black; padding: 2px;"><p>Pump 1 Pump 2</p></div>				
Select	Escape			

## AUXILIARY FUNCTIONS

### 10.1.1 Prime Burette

The *Prime Burette* option is used to mechanically fill the burette before starting a set of titrations. The priming process consists of several cycles of filling and emptying the burette with titrant.

Two rinse cycles of burette are shown in the figure below. The dispensing tube is connected on the right side and the aspiration tube on the left side.

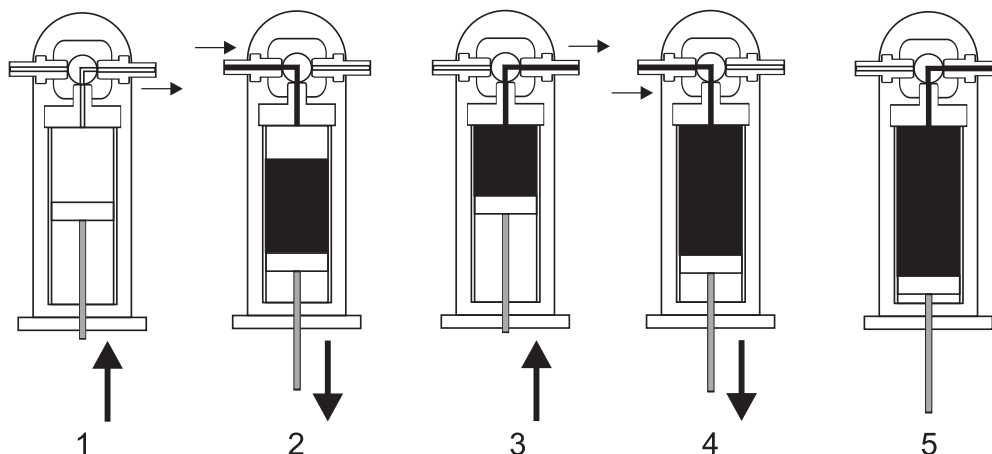

**Note:** Before starting this operation, the aspiration tube must be inserted in the titrant bottle. A waste container should be placed under the dispensing tip to collect the waste solution.

To prime the burette, select *Prime Burette* from the **Burette** screen. Enter the number of rinses and press .

The number of burette rinses can be set between 1 and 5 (we recommend at least three rinses to assure that the air bubbles are completely removed).

Total Burette Rinses				
Enter the total number of burette rinses.				
3				
A minimum of three rinses is recommended.				
Accept	Escape	Delete Digit		



### 10.1.2 Rinse Tip

A 2 mL dose of titrant will be dispensed from the burette when this operation is selected. This operation will eliminate the air from the dispensing tip.

### 10.1.3 Manual Dispense

*Manual Dispense* option allows a defined titrant volume to be dosed. Select the *Manual Dispense* option and press . The **Manual Volume Dispense** screen will become active and the display will prompt you to enter the desired volume to be dispensed.

Manual Volume Dispense				
Enter the amount of volume to be dispensed.				
1.000 mL				
Current burette volume is 10 mL.				
ACCEPT	Escape	Delete Digit		

The manual dispense volume must be between the limits shown below:

- 0.001 to 4.750 mL for a 5 mL burette
- 0.001 to 9.500 mL for a 10 mL burette
- 0.005 to 23.750 mL for a 25 mL burette
- 0.005 to 47.500 mL for a 50 mL burette

### 10.1.4 Purge Burette

This option allows the burette to be emptied before cleaning and/or storing the burette. The burette is flushed twice.

**Note:** Before starting this operation, remove the aspiration tube from the titrant bottle.

## AUXILIARY FUNCTIONS

The figures below show the steps in a purge burette operation.

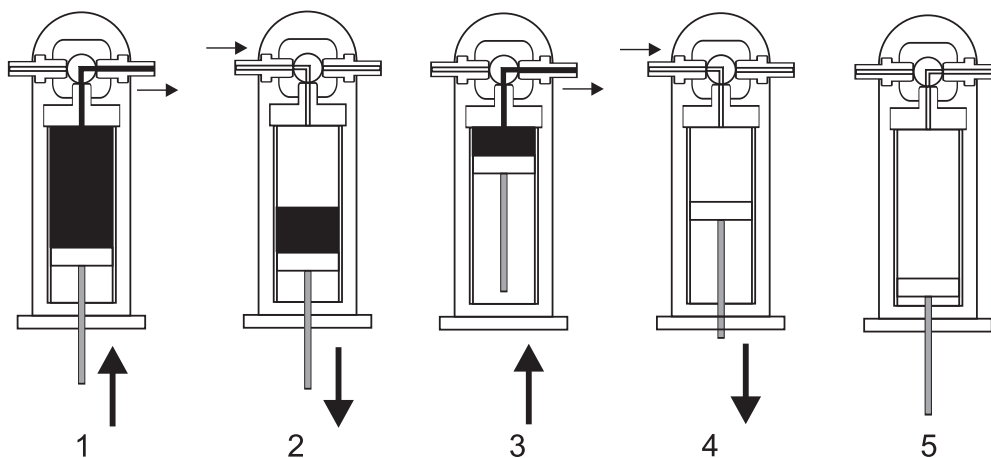

### 10.2 Stirrer

The stirrer can be turned on and off by pressing .

The stirring speed is set within the method parameters (see **Titration Methods**, *Stirring Speed* section).

During the titration process, the stirring speed can be manually adjusted by using the  $\triangle$  and  $\nabla$  keys.

### 10.3 Results

From the **Data Parameters** screen, you can access the following options:

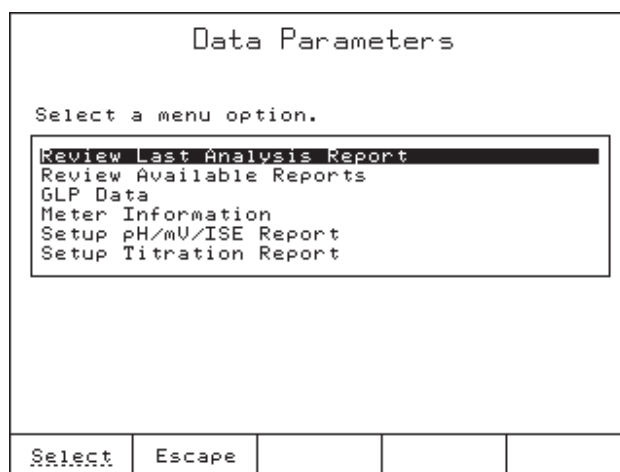

## 10.3.1 Review Last Analysis Report

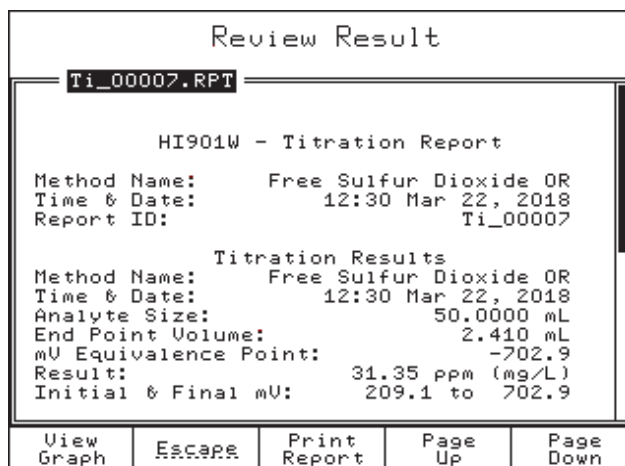

The last analysis report can be reviewed.

The titration graph can be reviewed by selecting .



The information seen in the report is based on the selections made in the **Setup Titration Report** screen.

The following option keys are available:

 Review the titration graph. The potentiometric titration curve is displayed. If the *Equivalence End Point* option was selected, the derivative curve (1<sup>st</sup> derivative, 2<sup>nd</sup> derivative) is simultaneously displayed. Pressing  will change the vertical axes scale units.

 Print the titration report.

 Return to the previous screen.

  Keys can be used to scroll through the pages.

# AUXILIARY FUNCTIONS

## 10.3.2 Review Available Reports



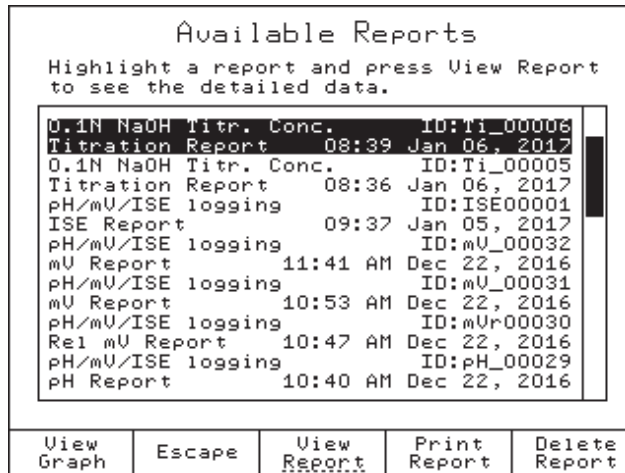

Up to 100 reports can be saved on the Titrator. To view one of the saved reports, highlight a report and then press .

All of the saved reports can be reviewed and printed.



The report contains only the information selected in the **Setup Titration Report** and **Setup pH/mV/ISE Report** screens during report configuration.

The following option keys are available:

-  Review the selected graph.
-  Review the selected report.
-  Print the selected report.
-  Delete the selected report.
-  Return to the previous screen.

## 10.3.3 GLP Data

Enter up to 20 alphanumeric characters for each option from **GLP Data** screen.

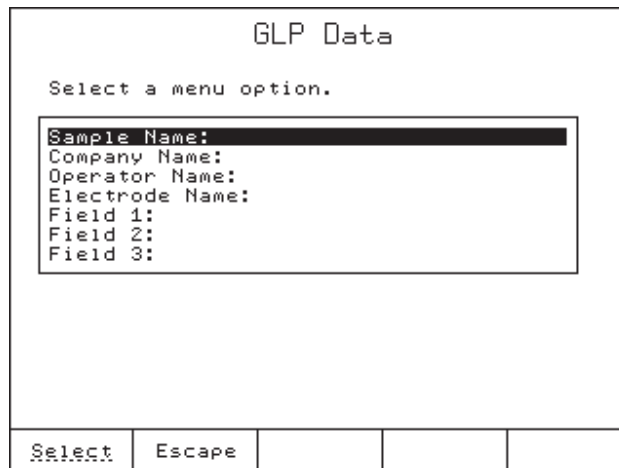

- Sample Name* Allows the sample name to be recorded in each report. The sample name will increase by one, with each new titration or logging report, if the last character is a number.
- Company Name* Allows the company name to be recorded in each report.
- Operator Name* Allows the operator name to be recorded in each report.
- Electrode Name* Allows the electrode name to be recorded in each report.
- Fields 1, 2, 3* Allows any additional information to be recorded in each report. The fields must be selected from **Setup Titration Report** screen (see *Setup pH/mV/ISE* section and *Setup Titration Report* section) in order to be displayed in the titration report.

### 10.3.4 Meter Information

Displays titrator configuration data.

```

Meter Information
HI901 Wine Titrator

SERIAL NUMBER
Titrator Serial Number:      64751607
Analog Board 1 Serial Number: 37540751
Pump 1 Serial Number:       70175108
Pump 2 Serial Number:       70164405

SOFTWARE VERSION
Titrator Software Version:    v1.00
Base Board Software Version:  v2.05
Pump 1 Software Version:     v1.4
Pump 2 Software Version:     v1.4

Analog 1 Calibration Date:   Jan 02, 2018
    
```

Escape	Print	
--------	-------	--

**Titrator Serial Number:** The serial number of the Titrator base board.

**Analog Board 1 Serial Number:** The serial number of the analog board.

**Pump 1 (and/or 2) Serial Number:** The serial number of the connected pump.

**Titrator Software Version:** The current software version installed on the Titrator.

**Base Board Software Version:** The current software version present on the base board of the Titrator.

**Pump 1 (and/or 2) Software Version:** The current software version for the pump.

**Analog 1 (and/or 2) Calibration Date:** Manufacturer calibration date of the analog board.

**Note:** If more than 1 year elapsed from the calibration date of the analog board 1 and/or 2, the message **Analog 1 Calibration Due** will appear on the main screen. The analog board needs to be recalibrated.

# AUXILIARY FUNCTIONS

## 10.3.5 Setup pH/mV/ISE Report

Customize a unique report to record the pH, mV, and ISE measurements. An asterisk means that it will be included in the report.

Setup pH/mV/ISE Report				
Select fields to be saved in the report.				
<ul style="list-style-type: none"><li>* Result and Units</li><li>* Potential</li><li>* Temperature and Units</li><li>* Date and Time</li><li>* Calibration Data</li><li>Sample Name</li><li>Company Name</li><li>Operator Name</li><li>Electrode Name</li><li>Field 1</li><li>Field 2</li><li>Field 3</li><li>Software Versions</li><li>Serial Numbers</li></ul>				
Select	Escape	Save Report		

## 10.3.6 Setup Titration Report

Customize a unique report to record the titration results. An asterisk means that it will be included in the titration report.

Setup Titration Report				
Select fields to be saved in the report.				
<ul style="list-style-type: none"><li>* Result and Units</li><li>* Titration Method</li><li>* Initial and Final Readings</li><li>* Analyte Size</li><li>* End Point Volume</li><li>* Titration Duration</li><li>* Date and Time</li><li>* Titration Ended By</li><li>All Data Points</li><li>Method Parameters</li><li>Standardization Data</li><li>Sample Name</li><li>Company Name</li><li>Operator Name</li></ul>				
Select	Escape	Save Report	Page Up	Page Down

## Chapter 11. Contents

<b>11</b>	<b>MAINTENANCE, PERIPHERALS .....</b>	<b>11-3</b>
<b>11.1</b>	<b>Burette Maintenance .....</b>	<b>11-3</b>
11.1.1	Burette Assembly .....	11-3
11.1.2	Changing the Burette .....	11-3
11.1.3	Disassembling the Burette .....	11-4
11.1.4	Assembling the Burette .....	11-4
11.1.5	Cleaning the Burette .....	11-5
11.1.6	Burette Preparation (Filling with Titrant) .....	11-7
<b>11.2</b>	<b>Peripherals .....</b>	<b>11-8</b>
11.2.1	Connecting an External Display .....	11-8
11.2.2	Connecting an External PC Keyboard .....	11-9
11.2.3	Connecting a Printer .....	11-11





### 11 MAINTENANCE, PERIPHERALS

The 25-mL burette included with the Titrator exceeds the ISO 8655 standard for accurate delivery of liquids by a motor-driven piston burette.

#### 11.1 Burette Maintenance

##### 11.1.1 Burette Assembly

The burette is delivered with a 25-mL syringe inside and with all of the accessories mounted (see **Setup, Unpacking** section for burette assembly details). The burette assembly consists of a rigid housing which holds the glass syringe, a 3-way valve and titrant tubing.

##### 11.1.2 Changing the Burette

Remove the burette from the pump assembly by sliding it forward and then slide the new burette into place (see the picture below).

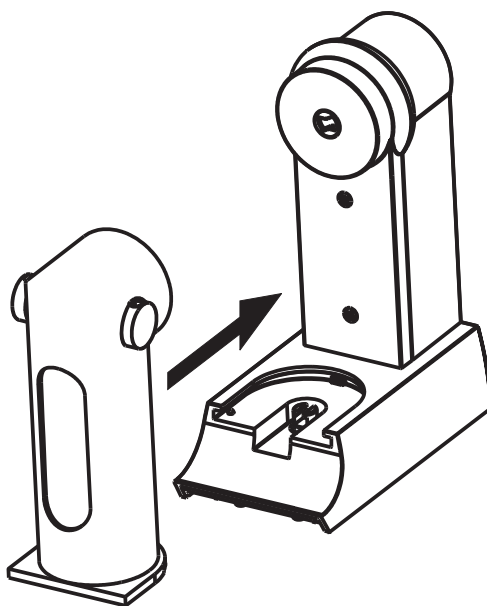

## MAINTENANCE, PERIPHERALS

### 11.1.3 Disassembling the Burette

The aspiration and the dispensing tubes have fittings and tube protectors. The aspiration tube will be mounted in the left side and the dispensing tube will be mounted in the right side of the burette.

To remove the dispensing tube and the aspiration tube follow these steps:

- Slide up the tube protector (3).
- Remove the tube lock (4) from the burette holder.
- Unscrew the fitting (2).
- Remove the tube.

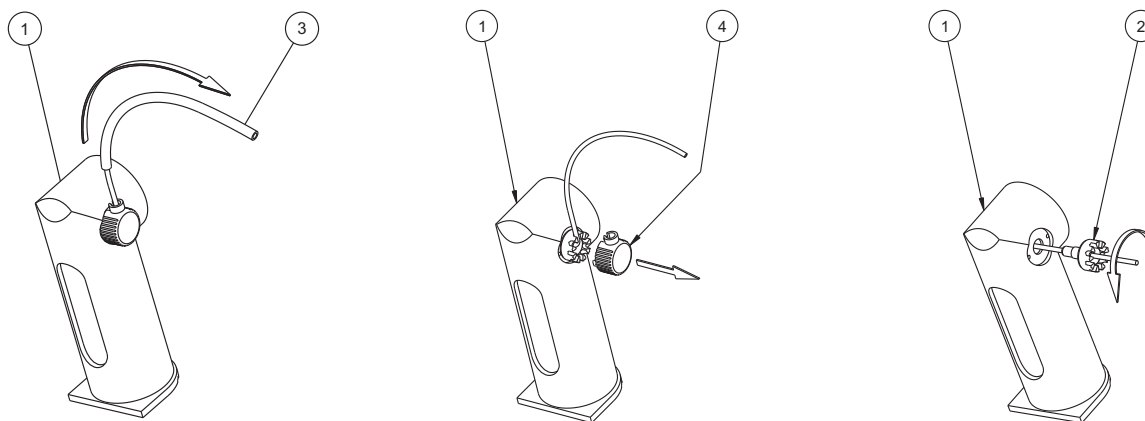

### 11.1.4 Assembling the Burette

To attach the dispensing tube and the aspiration tube, follow these steps:

- Insert the flat-shaped end of the dispensing tube into the valve outlet and screw in the fitting so that the highest of its 9 cuts stays vertically in the final position (2).
- Bend the tube up into the vertical position to enter the highest cut of the fitting (5).
- Put on the tube lock on the fitting (4).
- Slide down tightly the tube protector (3) into the dedicated gap of the tube lock.

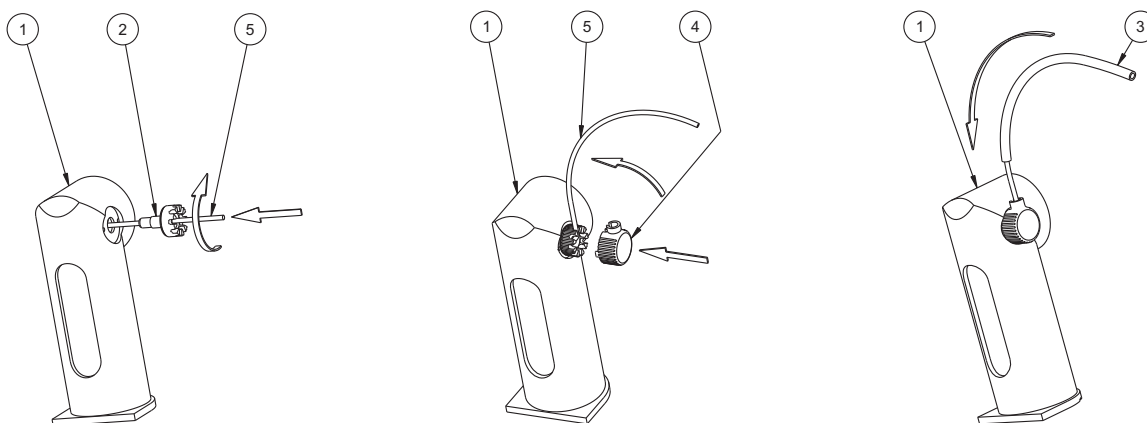

### 11.1.5 Cleaning the Burette

To clean the burette, follow these steps:

- If the burette is filled with titrant, remove the aspiration tube from the titrant bottle and purge burette (see **Auxiliary Functions, Purge Burette** section).
- Insert the aspiration tube into cleaning solution, deionized water or titrant solvent.
- Prime burette to fill the burette (use 2 rinses) (see **Auxiliary Functions, Prime Burette** section).
- During second refilling of the burette remove the aspiration tube out of the cleaning solution, deionized water, or solvent and allow the air to replace the liquid in the burette. This will clean the aspiration tube.

If this simple cleaning procedure is not adequate, continue with these steps:

- Slide the burette out from the pump assembly.
- Remove the dispensing and aspiration tubes. Clean them separately or insert new ones.
- Remove the protective cap from the bottom of the burette assembly by using the special tool.
- Remove the syringe from the burette assembly by unscrewing it with your fingers.
- Extract the piston from the syringe.
- Clean both the piston and the syringe with appropriate cleaning solution. Rinse with deionized water.
- Remove the excess liquid.

## MAINTENANCE, PERIPHERALS

---

**Warning:** Avoid contacting the titrant with bare hands.

*Avoid spilling titrant.*

*Clean the external side of the syringe and piston to remove aggressive chemicals.*

*Do not touch the white PTFE part of the piston or internal walls of the burette with bare hands or greasy materials.*

- Reinsert the piston into the syringe.
- Reinsert the syringe by screwing it in the valve with your fingers.
- Reinsert the protective cap to the bottom of the burette assembly. Carefully position the cap into the burette.
- Slide the burette into the burette stand. Notice the position of the piston shaft to the pump couple.
- Priming the burette three times with new titrant is recommended.

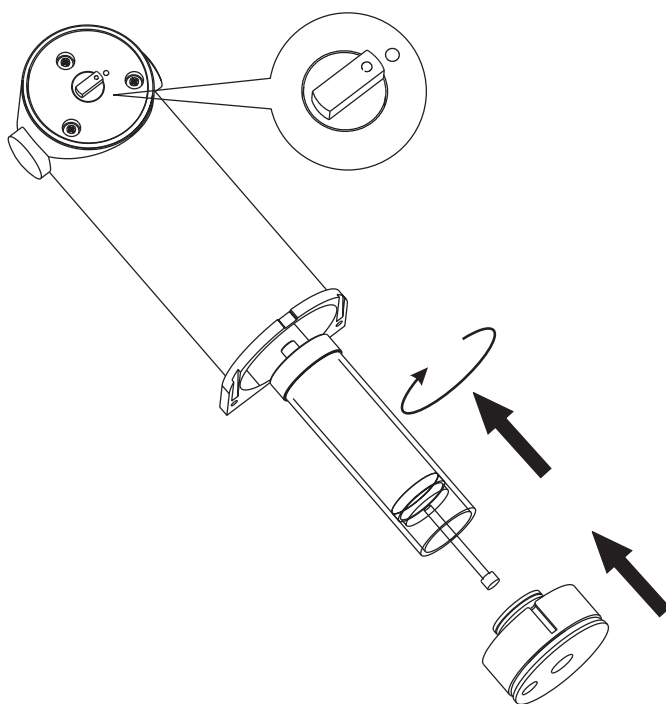

### 11.1.6 Burette Preparation (Titrant Filling)

Before starting a titration, the burette must be properly filled with titrant in order to obtain an accurate and repeatable result. To fill the burette, follow the next steps and recommendations:

- If necessary, clean the burette and make sure it is empty.
- From the main screen press .
- Highlight *Prime Burette* option and press .
- Enter the number of times the burette needs to be rinsed (minimum three rinses are recommend allowing air bubbles to be evacuated).
- Press .

To avoid the presence of the air bubbles inside the burette, make sure to have a continuous liquid flow inside the burette. A little air just above the liquid level at the first filling is normal. The next filling will evacuate all of the air; no air will be left in the valve.

Sometimes during this process, slight finger tapping on the tubes is helpful to remove any residual air bubbles from the tubes.

If air bubbles are still present:

- Remove the aspiration tube from the titrant bottle.
- Repeat burette preparation procedure.
- If this is not successful, clean the burette again.

# MAINTENANCE, PERIPHERALS

---

## 11.2 Peripherals

**Warning!** *Connection/disconnection of POWER, PUMP ASSEMBLY, EXTERNAL PC DISPLAY, PRINTER, RS232 INTERFACE must only be done when Titrator and external devices are turned off.*

### 11.2.1 Connecting an External Display

The information shown on the Titrator display can be viewed also on a Standard VGA display connected with a 15-pins cable, as presented below.

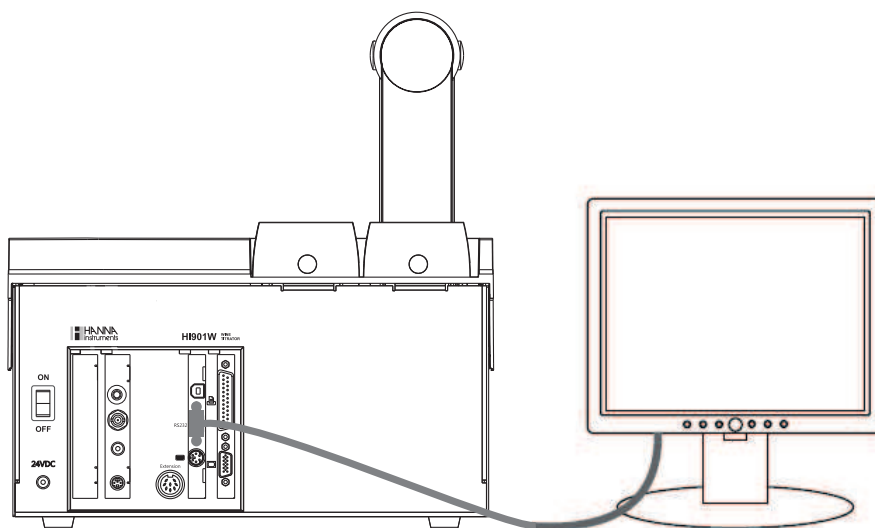

Connect the external display to the display socket.  
Turn on the Titrator and then the external display.

### 11.2.2 Connecting an External PC Keyboard



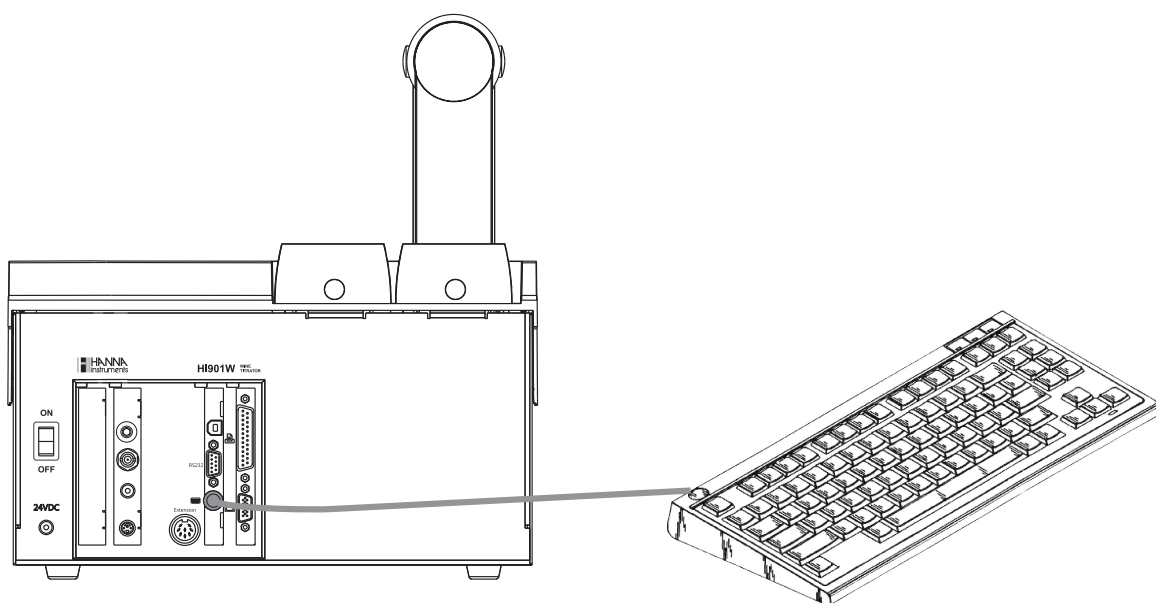









This connection allows you to use an external PS/2 PC Keyboard in addition to the titrator's keypad.



Connect an external PC Keyboard (PS/2 connector).

## MAINTENANCE, PERIPHERALS

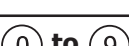
The correspondence between the titrator's keypad and the United States 101-type external keyboard are:

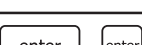
External PC Keyboard (United States 101)	Titrator Keypad
Function Key <b>F-1</b>	
Function Key <b>F-2</b>	
Function Key <b>F-3</b>	
Function Key <b>F-4</b>	
Function Key <b>F-5</b>	Option Key <b>1</b> (from left to right)
Function Key <b>F-6</b>	Option Key <b>2</b> (from left to right)
Function Key <b>F-7</b>	Option Key <b>3</b> (from left to right)
Function Key <b>F-8</b>	Option Key <b>4</b> (from left to right)
Function Key <b>F-9</b>	Option Key <b>5</b> (from left to right)
Function Key <b>F-10</b>	
Arrow Key: <b>Up</b>	
Arrow Key: <b>Down</b>	
Arrow Key: <b>Left</b>	
Arrow Key: <b>Right</b>	
<b>Page Up</b>	
<b>Page Down</b>	
Numeric Keys: <b>0 to 9</b>	
<b>Tab</b>	
<b>Enter</b>	
Alphanumeric Keys	Allow alphanumeric entries.



### 11.2.3 Connecting a Printer

A variety of parallel printers can be connected to the parallel port of the Titrator using a standard DB25-pin cable.

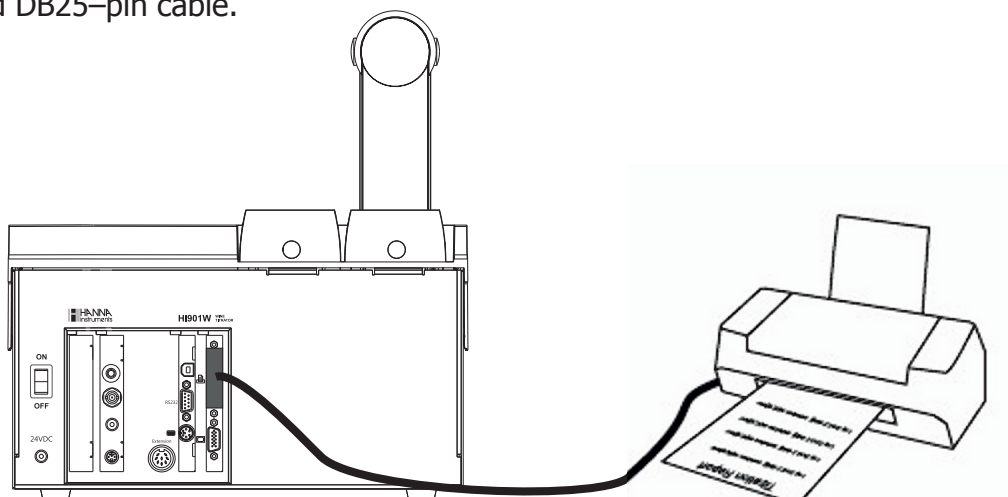

**Warning:** *The Titrator and the external printer must be both turned OFF before they are connected.*

Connect the external printer to the standard 25-pin Socket.  
Turn on the Titrator and then the printer.



**Appendix 1. Contents**

**HI901W TECHNICAL SPECIFICATIONS ..... A1-3**



HI 901C TECHNICAL SPECIFICATIONS

<b>mV</b>	Range	- 2000.0 to 2000.0 mV
	Resolution	0.1 mV
	Accuracy	±0.1 mV
<b>pH</b>	Range	- 2.000 to 20.000 pH
	Resolution	0.1 / 0.01 / 0.001 pH
	Accuracy	±0.001 pH
<b>ISE</b>	Range	1x10 <sup>-6</sup> to 9.99x10 <sup>10</sup>
	Resolution	1 / 0.1 / 0.01
	Accuracy	±0.5% (monovalent ion) ±1.0% (divalent ion)
<b>Temperature</b>	Range	- 5.0 to 105.0 °C 23.0 to 221.0 °F 268.2 to 378.2 K
	Resolution	0.1 °C / 0.1 °F / 0.1 K
	Accuracy	±0.1 °C / ±0.2 °F / ±0.1 K
<b>Burette Sizes</b>	Resolution	0.001 mL
	Accuracy	±0.005 mL (5 mL Burette) ±0.010 mL (10 mL Burette) ±0.025 mL (25 mL Burette) ±0.050 mL (50 mL Burette)
<b>Graphic Display</b>		5.7" graphical color display with backlight.
<b>Languages</b>		English, Portuguese, Spanish.
<b>Titration Methods</b>		up to 100 (standard and user methods)

**Burette size auto-detection and interchangeable burettes.** The Titrator automatically detects the size of the burette when it is slid into the pump assembly.

**Propeller Stirrer with Programmable Stir Speed.** The stirring speed can be set between 200 and 2500 RPM with 100 RPM resolution.

**Flow Rate:** user-selectable (see **Titration Methods**, *Volume/Flow Rate* section).

**mV / pH / ISE Measurement modes.**

**Automatically Temperature Compensated pH Measurements.**

**pH Calibration** with up to 5 buffers using *Auto-Entry* or *Manual-Entry* options; temperature compensated buffers are stored internally for *Auto-Entry* option.

**Relative mV calibration:** single point offset.

**ISE Calibration:** with up to 5 standards.

## APPENDIX 1

---

**Potentiometric Titrations:** Acid-Base (pH or mV-Mode), Redox, Precipitation, Complexometric, Non-Aqueous, Ion-Selective, Argentometric.

**Titer Determination.**

**Fixed mV or pH End Point Detection.**

**Single Equivalence Point Detection** with the 1<sup>st</sup> or 2<sup>nd</sup> Derivatives of the titration curve.

**Flexible Concentration Calculations** with many concentration units.

**Graph Display** during titration, graphs of the stored titration data (mV-Volume or pH-Volume titration curve, 1<sup>st</sup> derivative curve or 2<sup>nd</sup> derivative curve, in pH-mode or mV-mode) and pH/mV values versus time-data logging results.

**Data Storage:** up to 100 complete titration and pH/mV/ISE reports.

**Files Copied to and Restored from USB Storage Device:** Standard Methods, User Methods, Titration and pH/mV/ISE Logging Reports and Bitmap Files can be transferred to a PC using a USB storage device.

**Peripheral Units:**

External VGA Display

External PC Keyboard

Printer

**GLP Conformity:** Good Laboratory Practice and Instrumentation Data storage and printing capabilities.

**Mains:** 100-240 Vac, 50/60 Hz

**Power Draw:** 0.5 Amps

**Enclosure Material:** ABS plastic and Steel

**Keypad:** Polycarbonate

**Dimensions:** Width x Depth x Height = 390 x 350 x 380 mm

**Weight:** approx. 20 lbs. (9 Kg) (with 1 pump, stirrer and sensors)

**Operating Environment:** 10 to 40 °C, up to 95% relative humidity

**Storage Environment:** -20 to 70 °C, up to 95% relative humidity

**Appendix 2. Contents**

**A2 ACCESSORIES ..... A 2 - 3**

**A2.1 Solutions ..... A 2 - 3**

A2.1.1 pH Calibration Solutions .....A 2 - 3

A2.1.2 pH Calibration Solutions in FDA Approved Bottle .....A 2 - 3

A2.1.3 pH Technical Calibration Solutions .....A 2 - 3

A2.1.4 pH Millesimal Calibration Solutions .....A 2 - 3

A2.1.5 Electrode Cleaning Solutions .....A 2 - 4

A2.1.6 Electrode Cleaning Solutions in FDA Approved Bottle .....A 2 - 4

A2.1.7 Electrode Storage Solutions .....A 2 - 4

A2.1.8 Electrode Storage Solutions in FDA Approved Bottle .....A 2 - 4

A2.1.9 Refilling Electrolyte Solutions .....A 2 - 4

A2.1.10 Refilling Electrolyte Solutions in FDA Approved Bottle .....A 2 - 4

A2.1.11 ORP Pretreatment Solutions .....A 2 - 5

A2.1.12 Titration Reagents .....A 2 - 5

A2.1.13 Ion Selective Electrode Calibration Solutions .....A 2 - 5

**A2.2 Sensors ..... A 2 - 6**

A2.2.1 pH Electrodes .....A 2 - 6

A2.2.2 ORP Electrodes .....A 2 - 7

A2.2.3 Half-cell Electrodes .....A 2 - 7

A2.2.4 Ion Selective Electrodes .....A 2 - 8

A2.2.5 Temperature Sensor .....A 2 - 8

**A2.3 Titrator components ..... A 2 - 9**





**A2 ACCESSORIES****A2.1 Solutions****A2.1.1 pH Calibration Solutions**

HI7001M	—>	pH 1.68 Buffer Solution, 230 mL
HI7001L	—>	pH 1.68 Buffer Solution, 500 mL
HI7004M	—>	pH 4.01 Buffer Solution, 230 mL
HI7004L	—>	pH 4.01 Buffer Solution, 500 mL
HI7006M	—>	pH 6.86 Buffer Solution, 230 mL
HI7006L	—>	pH 6.86 Buffer Solution, 500 mL
HI7007M	—>	pH 7.01 Buffer Solution, 230 mL
HI7007L	—>	pH 7.01 Buffer Solution, 500 mL
HI7009M	—>	pH 9.18 Buffer Solution, 230 mL
HI7009L	—>	pH 9.18 Buffer Solution, 500 mL
HI7010M	—>	pH 10.01 Buffer Solution, 230 mL
HI7010L	—>	pH 10.01 Buffer Solution, 500 mL

**A2.1.2 pH Calibration Solutions in FDA Approved Bottle**

HI8004L	—>	pH 4.01 Buffer Solution, 500 mL
HI8006L	—>	pH 6.86 Buffer Solution, 500 mL
HI8007L	—>	pH 7.01 Buffer Solution, 500 mL
HI8009L	—>	pH 9.18 Buffer Solution, 500 mL
HI8010L	—>	pH 10.01 Buffer Solution, 500 mL

**A2.1.3 pH Technical Calibration Solutions**

HI5016	—>	pH 1.68 Buffer Solution, 500 mL
HI5003	—>	pH 3.00 Buffer Solution, 500 mL
HI5004	—>	pH 4.01 Buffer Solution, 500 mL
HI5068	—>	pH 6.86 Buffer Solution, 500 mL
HI5007	—>	pH 7.01 Buffer Solution, 500 mL
HI5091	—>	pH 9.18 Buffer Solution, 500 mL
HI5010	—>	pH 10.01 Buffer Solution, 500 mL
HI5124	—>	pH 12.45 Buffer Solution, 500 mL

**A2.1.4 pH Millesimal Calibration Solutions**

HI6016	—>	pH 1.679 Buffer Solution, 500 mL
HI6003	—>	pH 3.000 Buffer Solution, 500 mL
HI6004	—>	pH 4.010 Buffer Solution, 500 mL
HI6004-01	—>	pH 4.010 Buffer Solution, 1 L

## APPENDIX 2

---

HI6068	—>	pH 6.862 Buffer Solution, 500 mL
HI6007	—>	pH 7.010 Buffer Solution, 500 mL
HI6007-01	—>	pH 7.010 Buffer Solution, 1 L
HI6091	—>	pH 9.177 Buffer Solution, 500 mL
HI6010	—>	pH 10.010 Buffer Solution, 500 mL
HI6010-01	—>	pH 10.010 Buffer Solution, 1 L
HI6124	—>	pH 12.450 Buffer Solution, 500 mL

### A2.1.5 Electrode Cleaning Solutions

HI7061M	—>	General Purpose Solution, 230 mL
HI7061L	—>	General Purpose Solution, 500 mL
HI7073M	—>	Protein Cleaning Solution, 230 mL
HI7073L	—>	Protein Cleaning Solution, 500 mL
HI7074M	—>	Inorganic Cleaning Solution, 230 mL
HI7074L	—>	Inorganic Cleaning Solution, 500 mL
HI7077M	—>	Oil & Fat Cleaning Solution, 230 mL
HI7077L	—>	Oil & Fat Cleaning Solution, 500 mL

### A2.1.6 Electrode Cleaning Solutions in FDA Approved Bottle

HI8061L	—>	General Purpose Solution, 500 mL
HI8073L	—>	Protein Cleaning Solution, 500 mL
HI8077L	—>	Oil & Fat Cleaning Solution, 500 mL

### A2.1.7 Electrode Storage Solutions

HI70300M	—>	Storage Solution, 230 mL
HI70300L	—>	Storage Solution, 500 mL

### A2.1.8 Electrode Storage Solutions in FDA Approved Bottle

HI80300M	—>	Storage Solution, 230 mL
HI80300L	—>	Storage Solution, 500 mL

### A2.1.9 Refilling Electrolyte Solutions

HI7071	—>	3.5M KCl + AgCl Electrolyte, 30 mL, for single junction electrodes
HI7072	—>	1M KNO <sub>3</sub> Electrolyte, 30 mL
HI7075	—>	KNO <sub>3</sub> and KCl Electrolyte, 30 mL
HI7076	—>	1M NaCl Electrolyte, 30 mL
HI7078	—>	(NH <sub>4</sub> ) <sub>2</sub> SO <sub>4</sub> Electrolyte, 30 mL
HI7082	—>	3.5M KCl Electrolyte, 30 mL, for double junction electrodes

### A2.1.10 Refilling Electrolyte Solutions in FDA Approved Bottle

HI8071	—>	3.5M KCl + AgCl Electrolyte, 30 mL, for single junction electrodes
HI8082	—>	3.5M KCl Electrolyte, 30 mL, for double junction electrodes

**A2.1.11 ORP Pretreatment Solutions**

HI7091M	—>	Reducing Pretreatment Solution, 230 mL
HI7091L	—>	Reducing Pretreatment Solution, 500 mL
HI7092M	—>	Oxidizing Pretreatment Solution, 230 mL
HI7092L	—>	Oxidizing Pretreatment Solution, 500 mL

**A2.1.12 Titration Reagents**

HI70429	—>	0.05 M AgNO <sub>3</sub> Titration Reagent, 1 L
HI70433	—>	0.01 N Stabilized Iodine Titration Reagent, 1 L
HI70439	—>	0.1 M Na <sub>2</sub> S <sub>2</sub> O <sub>3</sub> Titration Reagent, 1 L
HI70440	—>	0.02 N Stabilized Iodine Titration Reagent, 1 L
HI70441	—>	0.04 N Stabilized Iodine Titration Reagent, 1 L
HI70448	—>	0.02 M AgNO <sub>3</sub> Titration Reagent, 1 L
HI70449	—>	0.02 M EDTA Titration Reagent, 1 L
HI70455	—>	0.01 N NaOH Titration Reagent, 1 L
HI70456	—>	0.1 N NaOH Titration Reagent, 1 L
HI70457	—>	1 N NaOH Titration Reagent, 1 L
HI70458	—>	0.01 M H <sub>2</sub> SO <sub>4</sub> Titration Reagent, 1 L
HI70459	—>	0.05 M H <sub>2</sub> SO <sub>4</sub> Titration Reagent, 1 L
HI70462	—>	0.01 N HCl Titration Reagent, 1 L
HI70463	—>	0.1 N HCl Titration Reagent, 1 L
HI70464	—>	1 N HCl Titration Reagent, 1 L

**A2.1.13 Ion Selective Electrode Calibration Solutions**

HI4001-01	—>	0.1 M Ammonia Standard
HI4001-02	—>	100 ppm Ammonia Standard (as N)
HI4001-03	—>	1000 ppm Ammonia Standard (as N)
HI4002-01	—>	0.1 M Bromide Standard
HI4003-01	—>	0.1 M Cadmium Standard
HI4004-01	—>	0.1 M Calcium Standard
HI4005-01	—>	0.1 M Carbon Dioxide Standard
HI4005-03	—>	1000 ppm Carbon Dioxide Standard (as CaCO <sub>3</sub> )
HI4007-01	—>	0.1 M Chloride Standard
HI4007-02	—>	100 ppm Chloride Standard
HI4007-03	—>	1000 ppm Chloride Standard
HI4008-01	—>	0.1 M Cupric Standard
HI4010-01	—>	0.1 M Fluoride Standard
HI4010-02	—>	100 ppm Fluoride Standard
HI4010-03	—>	1000 ppm Fluoride Standard
HI4011-01	—>	0.1 M Iodide Standard
HI4012-01	—>	0.1 M Lead Standard

## APPENDIX 2

---

HI4012-21	—>	0.1 M Sulfate Standard
HI4013-01	—>	0.1 M Nitrate Standard
HI4013-02	—>	100 ppm Nitrate Standard
HI4013-03	—>	1000 ppm Nitrate Standard
HI4014-01	—>	0.1 M Potassium Standard
HI4015-01	—>	0.1 M Silver Standard

### A2.2 Sensors

#### A2.2.1 pH Electrodes

##### HI1043B

Glass-body, double junction, refillable, combination pH electrode.

Use: strong acid and base, paint and solvents

##### HI1053B

Glass-body, triple ceramic, conic shape, refillable, combination pH electrode.

Use: emulsions, fats and creams, soil and semi-solids samples

##### HI1083B

Glass-body, micro, Viscolene, nonrefillable, combination pH electrode.

Use: biotechnology and micro titration

##### HI1131B

Glass-body, double junction, refillable, combination pH electrode.

Use: general purpose

##### HI1330B

Glass-body, semimicro, single junction, refillable, combination pH electrode.

Use: laboratory, vials, and test tubes

##### HI1331B

Glass-body, semimicro, single junction, refillable, combination pH electrode.

Use: flasks

##### HI1230B

Plastic-body (PEI), double junction, gel-filled, combination pH electrode.

Use: general purpose

##### HI2031B

Glass-body, conical tip, refillable, combination pH electrode.

Use: dairy and semi-solid products

##### HI1332B

Plastic-body (PEI), double junction, refillable, combination pH electrode.

Use: chemicals, field applications and quality control testing.

##### FC100B

Plastic-body (PVDF), double junction, refillable, combination pH electrode.

Use: sauces, juices, dairy products and other liquids or slurry forms of food

**FC200B**

Plastic-body (PVDF), single junction, conical tip, non-refillable Viscolene electrolyte, combination pH electrode.

Use: dairy, dough, ground meats and other semi-solid food

**FC210B**

Glass-body, double junction, conical tip, non-refillable Viscolene electrolyte, combination pH electrode.

Use: milk, yogurt, and cream

**FC220B**

Glass-body, single junction, refillable, combination pH electrode.

Use: milk, yogurt, cream, sauce, and fruit juices

**FC911B**

Plastic-body (PVDF), double junction, refillable, combination pH electrode.

Use: sauce, juices, dairy products and other liquid or slurry forms of food

**HI1413B**

Glass-body, single junction, flat tip, non-refillable Viscolene electrolyte, combination pH electrode.

Use: surfaces, skin, leather, paper, and emulsions

**A2.2.2 ORP Electrodes****HI3131B**

Glass-body, refillable, combination platinum ORP electrode.

Use: laboratories and general purpose

**HI3230B**

Plastic-body (PEI), gel-filled, combination platinum ORP electrode.

Use: municipal water and quality control

**HI4430B**

Plastic-body (PEI), gel-filled, combination gold ORP electrode.

Use: oxidants and ozone

**A2.2.3 Half-cell Electrodes****HI2110B**

Glass-body, single half-cell pH electrode.

Use: general purpose

**HI5311**

Glass-body, Ag/AgCl reference half-cell electrode, double junction, refillable with 4mm banana plug with 1m (3.3') cable.

Use: general purpose with wide temperature range

## APPENDIX 2

---

### **HI5315**

Plastic-body (PEI), double junction, Ag/AgCl reference half-cell electrode, refillable with 4mm plug with 1 m (3.3') cable.

Use: Ion Selective Electrodes

### **HI5412**

Glass-body, single Calomel reference half-cell electrode, refillable with 4mm plug with 1m (3.3') cable.

Use: general purpose with constant temperature range

### **A2.2.4 Ion Selective Electrodes**

**HI4101** Ammonia ISE

**HI4002 / HI4102** Bromide ISE

**HI4003 / HI4103** Cadmium ISE

**HI4004 / HI4104** Calcium ISE

**HI4105** Carbon Dioxide ISE

**HI4007 / HI4107** Chloride ISE

**HI4008 / HI4108** Cupric ISE

**HI4009 / HI4109** Cyanide ISE

**HI4010 / HI4110** Fluoride ISE

**HI4011 / HI4111** Iodide ISE

**HI4012 / HI4112** Lead ISE

**HI4013 / HI4113** Nitrate ISE

**HI4014 / HI4114** Potassium ISE

**HI4015 / HI4115** Silver / Sulfide ISE

**FC300B** Sodium

### **A2.2.5 Temperature Sensor**

#### **HI7662-T**

Temperature probe with 1 m (3.3') paneled cable.

**A2.3 Titrator components**

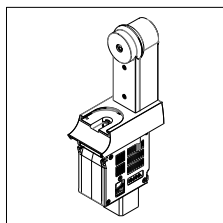

Pump Assembly  
**HI900100**

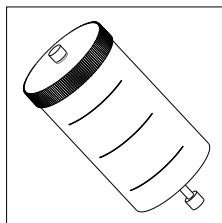

50 mL Syringe  
**HI900250**

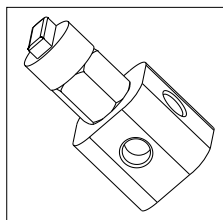

3 Way Valve  
**HI900260**

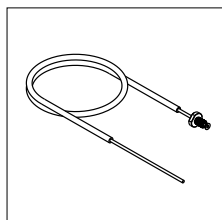

Aspiration Tube with fitting  
and protection tube  
**HI900270**

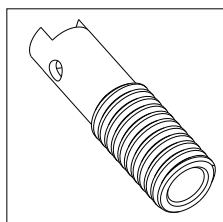

Tool for burette cap removal  
**HI900942**

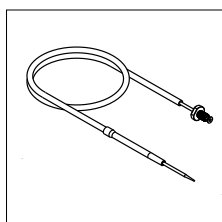

Dispensing Tube with normal  
dispensing tip, fitting, protection  
tube and tube guide  
**HI900280**

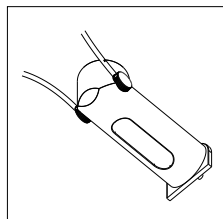

Burette with:  
5 mL syringe - **HI900105**  
10 mL syringe - **HI900110**  
25 mL syringe - **HI900125**  
50 mL syringe - **HI900150**

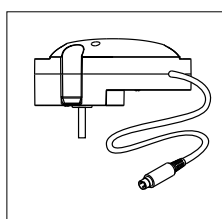

Overhead Stirrer +  
3 propellers  
**HI900301**

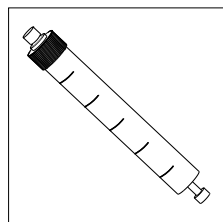

5 mL Syringe  
**HI900205**

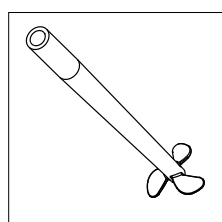

Propeller  
**HI900302**

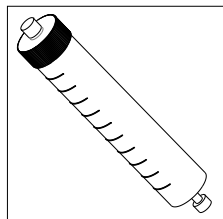

10 mL Syringe  
**HI900210**

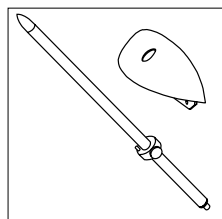

Stirrer Support and Stand  
**HI900320**

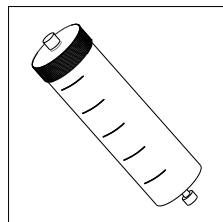

25 mL Syringe  
**HI900225**

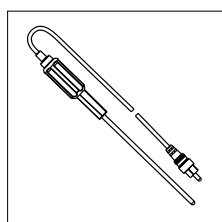

Temperature Probe  
**HI7662-T**

## APPENDIX 2

---

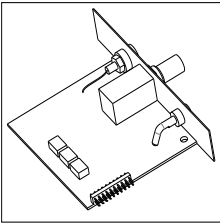

Potentiometric Analog Board  
**HI900401**

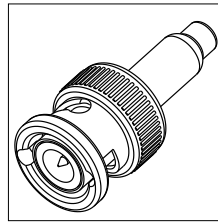

Shorting Cap  
**HI900945**

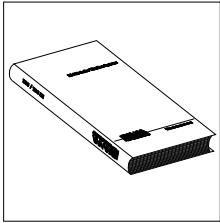

Instruction Manual Binder  
**HI900801W**

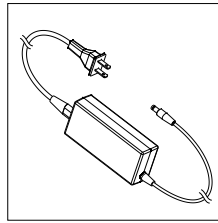

Power Adapter  
**HI900946**

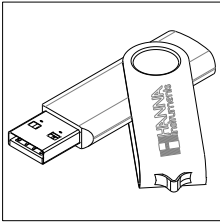

USB Storage Device  
**HI900900W**

MANG01W  
03/18



## 0.1N Sodium Hydroxide Titrant Concentration

### Description:

Method for the standardization (titer determination) of 0.1N Sodium Hydroxide (NaOH) titrant solution against Potassium Hydrogen Phthalate (KHP). The results are expressed in **N (eq/L)**.

### Reference:

AOAC Official Methods of Analysis, Official Method 936.16

### Electrode:

- HI1131B Combination pH Electrode
- HI7662-T Temperature Probe

### Reagents:

- HI70456 0.1N Sodium Hydroxide (1 L)
- HI70401 Potassium Hydrogen Phthalate (20 g)
- HI70436 Deionized Water (1 gal)

### Accessories:

- HI70300L Storage Solution (500 mL)
- HI7071 Electrode Fill Solution (30 mL x 4)
- HI7004L pH 4.01 Buffer Solution (500 mL)
- HI7007L pH 7.01 Buffer Solution (500 mL)
- HI7010L pH 10.01 Buffer Solution (500 mL)
- HI740036P 100-mL Plastic Beakers (10 pcs)
- Analytical Balance with 0.0001 g resolution

### Device Preparation:

- Connect the pH electrode and temperature probe to the titrator.
- Install a 25-mL burette filled with 0.1N sodium hydroxide (HI70456) on pump-one and verify that no air bubbles are present in the burette or tubing. If necessary prime the burette until all the air has been removed completely.
- Press "*Select Method*" from the main screen. Use the arrow keys to highlight 'HI0001EN 0.1N Sodium Hydroxide' and press "*Select*".

### Electrode Preparation:

- Press "*Mode*" from the main screen and press "*pH*".
- Calibrate the electrode using pH 4.01, 7.01 and 10.01 buffers. Refer to the instruction manual for calibration procedure.

### Sample Preparation:

- Crush approximately 3 grams of potassium hydrogen phthalate (HI70401) and dry it for 2 hours at 120°C. Cool to room temperature in a desiccator.
- Place a clean 100-mL plastic beaker on the analytical balance.
- Zero the balance.
- Carefully weigh approximately 0.20 grams of dried potassium hydrogen phthalate into the beaker.

**NOTE:** Ensure that all of the potassium hydrogen phthalate is on the bottom of the beaker.

- Record the exact weight of the sample once the balance has stabilized with an accuracy of 0.0001 grams.
- Remove the beaker from the balance and add deionized water to the 50-mL mark on the beaker.

### Analysis:

- Place the beaker under the stirrer assembly and lower it to immerse the pH electrode, temperature probe and stirrer. Ensure that the reference junction of the pH electrode is 5-6 mm below the surface. If necessary add extra deionized water.

**NOTE:** The dispensing tip should be in contact with the surface of the sample (slightly submerged).

- Press "*Start*". You will be prompted to enter the analyte size (weight of potassium hydrogen phthalate). Use the numeric keypad to enter the exact weight and press "*Enter*" to start the analysis.

**NOTE:** Ensure that the potassium hydrogen phthalate dissolves completely during the pre-titration stir time. Erroneous results may occur if the sample does not dissolve completely prior to titration. If necessary the pre-titration stir time can be increased.

- At the end of the titration, after detection of the equivalence point, 'titration complete' will appear with the titrant concentration. The result is expressed in **N (eq/L) of sodium hydroxide**.
- Remove the pH electrode, temperature probe and stirrer from the sample and rinse them thoroughly with deionized water.
- Record the result.

**NOTE:** For improved accuracy, repeat this procedure a minimum of three times and calculate the average value.

**For methods utilizing 0.1N sodium hydroxide titrant solution, follow the steps below to enter the titer/standardized value.**

- Select the method utilizing 0.1N sodium hydroxide.
- Select "*Method Options*" from the main screen.
- Using the arrow keys, highlight 'Titrant Conc.' and press "*Select*".
- Use the numeric keypad to enter the standardized (titer) value of the titrant then press "*Accept*".
- Press "*Escape*" to exit the Method Options screen and select 'Save Method' option.

**0.1N Sodium Hydroxide Titrant Concentration****Method Parameters:**

Name: 0.1N Sodium Hydroxide  
 Method Revision: 3.0  
 Stirrer Configuration:  
 Stirrer: Stirrer 1  
 Stirring Speed: 1400 RPM  
 Pump Configuration:  
 Titrant Pump: Pump 1  
 Dosing Type: Dynamic  
 min Vol: 0.030 mL  
 max Vol: 0.500 mL  
 delta E: 4.500 mV  
 End Point Mode: pH 1EQ point, 1st Dev  
 Recognition Options:  
 Threshold: 500 mV/mL  
 Range: NO  
 Filtered Derivatives: NO  
 Pre-Titration Volume: 5.000 mL  
 Pre-Titration Stir Time: 60 Sec  
 Measurement Mode: Signal Stability  
 delta E: 0.3 mV  
 delta t: 1.5 Sec  
 t-min wait: 3 Sec  
 t-max wait: 30 Sec  
 Electrode Type: pH  
 Blank Option: No Blank  
 Calculations: Stdz. Titrant by Weight  
 Dilution Option: Disabled  
 Titrant Name: 0.1N NaOH  
 Analyte Size: 0.200 g  
 Analyte Entry: Manual  
 Maximum Titrant Volume: 15.000 mL  
 Potential Range: -2000.0 to 2000.0 mV  
 Volume/Flow Rate: 25 mL/50 mL/min  
 Signal Averaging: 1 Reading  
 Final Result Format: XXXXX

**Results:**

Titration Report  
 Method Name: 0.1N Sodium Hydroxide  
 Time & Date: 17:03 Jun 07, 2016  
 Titration ID: Ti\_00053

**Titration Results**

Method Name: 0.1N Sodium Hydroxide  
 Time & Date: 17:03 Jun 07, 2016  
 Analyte size: 0.20920 g  
 End Point Volume: 10.215 mL  
 pH Equivalence Point: 8.394  
 Results: 0.10027 N(eq/L)  
 Initial and Final pH: 4.173 to 9.570  
 Titration Duration: 6:25 [mm:ss]  
 Titration went to Completion  
 Operator name: \_\_\_\_\_

**Calculations:**

Calculations: Stdz. Titrant by Weight  
 Titrant units: N (eq/L)  
 Titrant volume dosed: V (L)  
 Standard weight: 0.200 g  
 Titrant/Standard: 1.000 eq/mol  
 MW of standard: 204.23 g/mol

$$N \text{ (eq/L)} = \frac{0.200 \times 1.000}{204.23 \times V(L)}$$

## 0.1M Sodium Thiosulfate Titrant Concentration

### Description:

Method for the standardization (titer determination) of 0.1M Sodium Thiosulfate ( $\text{Na}_2\text{S}_2\text{O}_3$ ) titrant solution against Potassium Iodate ( $\text{KIO}_3$ ). The results are expressed in **M (mol/L)**.

### Reference:

Standard Methods for the Examination of Water and Wastewater 19<sup>th</sup> Edition, Method 4500-Cl B

### Electrode:

- HI3131B Combination ORP Electrode

### Reagents:

- HI70439 0.1M Sodium Thiosulfate (1 L)
- HI70407 Potassium Iodate (20 g)
- HI70425 16% Sulfuric Acid (500 mL)
- HI70468 Potassium Iodide (35 g)
- HI70436 Deionized Water (1 gal)

### Accessories:

- HI70300L Storage Solution (500 mL)
- HI7071 Electrode Fill Solution (30 mL x 4)
- HI740036P 100-mL Plastic Beakers (10 pcs)
- Analytical Balance 0.0001 g
- 100-mL Class-A Volumetric Flask
- 10-mL Class-A Volumetric Pipette

### Device Preparation:

- Connect the ORP electrode to the titrator.
- Press "*Select Method*" from the main screen. Use the arrow keys to highlight 'HI003EN 0.1M Sodium Thiosulfate' and press "*Select*".
- Install a 25-mL burette filled with 0.1M sodium thiosulfate (HI70439) on pump-one and verify that no air bubbles are present in the burette or tubing. If necessary prime the burette until all the air has been removed completely.

### Electrode Preparation:

- Prepare the ORP electrode according to the procedure in the manual.

### Sample Preparation:

- Crush approximately 2 grams of potassium iodate (HI70407) and dry it for 2 hours at 120°C. Cool to room temperature in a desiccator.
- Carefully weigh approximately 0.35 grams of dried potassium iodate.
- Record the exact weight of the sample once the balance has stabilized with an accuracy of 0.0001 grams.
- Carefully transfer the salt to a 100-mL class-A volumetric flask. Add approximately 80 mL of deionized water, and mix to dissolve. Once the salt is completely dissolved bring the flask to volume with deionized water, mix well.

- Use a class-A volumetric pipette to transfer exactly 10.00 mL of the solution to a clean 100-mL plastic beaker. Add deionized water to the 50-mL mark on the beaker.
- Add 5 mL of 16% sulfuric acid (HI70425) and 1.5 grams of potassium iodide (HI70468) to the beaker.

### Analysis:

- Place the beaker under the stirrer assembly and lower it to immerse the ORP electrode and stirrer. Ensure that the reference junction of the ORP electrode is 5-6 mm below the surface. If necessary add extra deionized water.

**NOTE:** The dispensing tip should be in contact with the surface of the sample (slightly submerged).

- Press "*Start*". You will be prompted to enter the analyte size (weight of potassium iodate). Use the numeric keypad to enter the exact weight and press "*Enter*" to start the analysis.
- At the end of the titration, after detection of the equivalence point, 'titration complete' will appear with the titrant concentration. The result is expressed in **M (mol/L) of sodium thiosulfate**.
- Remove the ORP electrode and stirrer from the sample and rinse them thoroughly with deionized water.
- Record the result.

**NOTE:** For improved accuracy, repeat this procedure a minimum of three times and calculate the average value.

**For methods utilizing 0.1M sodium thiosulfate titrant solution, follow the steps below to enter the titer/standardized value.**

- Select the method utilizing 0.1M sodium thiosulfate.
- Select "*Method Options*" from the main screen.
- Using the arrow keys, highlight 'Titrant Conc.' and press "*Select*".
- Use the numeric keypad to enter the standardized (titer) value of the titrant then press 'Accept'.
- Press "*Escape*" to exit the Method Options screen and select 'Save Method' option.

**0.1M Sodium Thiosulfate Titrant Concentration****Method Parameters:**

Name: 0.1M Sodium Thiosulfate  
 Method Revision: 3.0  
 Stirrer Configuration:  
 Stirrer: Stirrer 1  
 Stirrer Speed: 1400 RPM  
 Pump Configuration:  
 Titrant Pump: Pump 1  
 Dosing Type: Dynamic  
 min Vol: 0.030 mL  
 max Vol: 0.600 mL  
 delta E: 6.500 mV  
 End Point Mode: mV 1EQ point, 1st Dev  
 Recognition Options:  
 Threshold: 50 mV/mL  
 Range: NO  
 Filtered Derivatives: NO  
 Pre-Titration Volume: 5.000 mL  
 Pre-Titration Stir Time: 0 Sec  
 Measurement Mode: Signal Stability  
 delta E: 0.3 mV  
 delta t: 2.0 Sec  
 t-min wait: 2 Sec  
 t-max wait: 20 Sec  
 Electrode Type: ORP  
 Blank Option: No Blank  
 Calculations: Stdz. Titrant by Weight  
 Dilution Option: Enabled  
 Final Dilution Volume: 100.000 mL  
 Aliquot Volume: 10.000 mL  
 Titrant Name: 0.1M Na<sub>2</sub>S<sub>2</sub>O<sub>3</sub>  
 Analyte Size: 0.35000 g  
 Analyte Entry: Manual  
 Maximum Titrant Volume: 15.000 mL  
 Potential Range: -2000.0 to 2000.0 mV  
 Volume/Flow Rate: 25 mL/50 mL/min  
 Signal Averaging: 1 Reading  
 Final Result Format: XXXXX

**Results:**

Titration Report  
 Method Name: 0.1M Sodium Thiosulfate  
 Time & Date: 17:10 Jun 22, 2016  
 Titration ID: Ti\_00073

Titration Results  
 Method Name: 0.1M Sodium Thiosulfate  
 Time & Date: 17:10 Jun 22, 2016  
 Analyte size: 0.35020 g  
 End Point Volume: 9.635 mL  
 mV Equivalence Point: 233.0  
 Results: 0.10191 M (mol/L)  
 Initial and Final mV: 361.8 to 173.4  
 Titration Duration: 2:51 [mm:ss]  
 Titration went to Completion  
 Operator name: \_\_\_\_\_

**Calculations:**

Calculations: Stdz. Titrant by Weight  
 Titrant units: M (mol/L)  
 Titrant volume dosed: V (L)  
 Standard weight: 0.350 g  
 Dilution Factor: 0.100  
 Final Dilution volume: 100.000 mL  
 Aliquot Volume: 10.000 mL  
 Titrant/Standard: 6.000 mol/mol  
 MW of standard: 214.00 g/mol  

$$M \text{ (mol/L)} = \frac{0.350 * 0.100 * 6.000}{214.00 * V(L)}$$

## 0.01N Sodium Hydroxide Titrant Concentration

### Description:

Method for the standardization (titer determination) of 0.01N Sodium Hydroxide (NaOH) titrant solution against Potassium Hydrogen Phthalate (KHP). The results are expressed in **N (eq/L)**.

### Reference:

AOAC Official Methods of Analysis, Official Method 936.16

### Electrode:

- HI1131B Combination pH Electrode
- HI7662-T Temperature Probe

### Reagents:

- HI70455 0.01N Sodium Hydroxide (1 L)
- HI70401 Potassium Hydrogen Phthalate (20 g)
- HI70436 Deionized Water (1 gal)

### Accessories:

- HI70300L Storage Solution (500 mL)
- HI7071 Electrode Fill Solution (30 mL x 4)
- HI7004L pH 4.01 Buffer Solution (500 mL)
- HI7007L pH 7.01 Buffer Solution (500 mL)
- HI7010L pH 10.01 Buffer Solution (500 mL)
- HI740036P 100-mL Plastic Beakers (10 pcs)
- Analytical Balance with 0.0001 g resolution

### Device Preparation:

- Connect the pH electrode and temperature probe to the titrator.
- Install a 25-mL burette filled with 0.01N sodium hydroxide (HI70455) on pump-one and verify that no air bubbles are present in the burette or tubing. If necessary prime the burette until all the air has been removed completely.
- Press "*Select Method*" from the main screen. Use the arrow keys to highlight 'HI0015EN 0.01N Sodium Hydroxide' and press "*Select*".

### Electrode Preparation:

- Press "*Mode*" from the main screen and press "*pH*".
- Calibrate the electrode using pH 4.01, 7.01 and 10.01 buffers. Refer to the instruction manual for calibration procedure.

### Sample Preparation:

- Crush approximately 3 grams of potassium hydrogen phthalate (HI70401) and dry it for 2 hours at 120°C. Cool to room temperature in a desiccator.
- Place a clean 100-mL plastic beaker on the analytical balance.
- Zero the balance.
- Carefully weigh approximately 0.02 grams of dried potassium hydrogen phthalate into the beaker.

**NOTE:** Ensure that all of the potassium hydrogen phthalate is on the bottom of the beaker.

- Record the exact weight of the sample once the balance has stabilized with an accuracy of 0.0001 grams.
- Remove the beaker from the balance and add deionized water to the 50-mL mark on the beaker.

### Analysis:

- Place the beaker under the stirrer assembly and lower it to immerse the pH electrode, temperature probe and stirrer. Ensure that the reference junction of the pH electrode is 5-6 mm below the surface. If necessary add extra deionized water.
- **NOTE:** The dispensing tip should be in contact with the surface of the sample (slightly submerged).
- Press "*Start*". You will be prompted to enter the analyte size (weight of potassium hydrogen phthalate). Use the numeric keypad to enter the exact weight and press "*Enter*" to start the analysis.
- **NOTE:** Ensure that the potassium hydrogen phthalate dissolves completely during the pre-titration stir time. Erroneous results may occur if the sample does not dissolve completely prior to titration. If necessary the pre-titration stir time can be increased.
- At the end of the titration, after detection of the equivalence point, 'titration complete' will appear with the titrant concentration. The result is expressed in **N (eq/L) of sodium hydroxide**.
- Remove the pH electrode, temperature probe and stirrer from the sample and rinse them thoroughly with deionized water.
- Record the result.

**NOTE:** For improved accuracy, repeat this procedure a minimum of three times and calculate the average value.

**For methods utilizing 0.01N sodium hydroxide titrant solution, follow the steps below to enter the titer/standardized value.**

- Select the method utilizing 0.01N sodium hydroxide.
- Select "*Method Options*" from the main screen.
- Using the arrow keys, highlight 'Titrant Conc.' and press "*Select*".
- Use the numeric keypad to enter the standardized (titer) value of the titrant then press "*Accept*".
- Press "*Escape*" to exit the Method Options screen and select 'Save Method' option.

**0.01N Sodium Hydroxide Titrant Concentration****Method Parameters:**

Name: 0.01N Sodium Hydroxide  
 Method Revision: 3.0  
 Stirrer Configuration:  
 Stirrer: Stirrer 1  
 Stirring Speed: 1400 RPM  
 Pump Configuration:  
 Titrant Pump: Pump 1  
 Dosing Type: Dynamic  
 min Vol: 0.030 mL  
 max Vol: 0.500 mL  
 delta E: 4.500 mV  
 End Point Mode: pH 1EQ point, 1st Dev  
 Recognition Options:  
 Threshold: 185 mV/mL  
 Range: NO  
 Filtered Derivatives: NO  
 Pre-Titration Volume: 5.000 mL  
 Pre-Titration Stir Time: 60 Sec  
 Measurement Mode: Signal Stability  
 delta E: 0.3 mV  
 delta t: 1.5 Sec  
 t-min wait: 3 Sec  
 t-max wait: 30 Sec  
 Electrode Type: pH  
 Blank Option: No Blank  
 Calculations: Stdz. Titrant by Weight  
 Dilution Option: Disabled  
 Titrant Name: 0.01N NaOH  
 Analyte Size: 0.0200 g  
 Analyte Entry: Manual  
 Maximum Titrant Volume: 15.000 mL  
 Potential Range: -2000.0 to 2000.0 mV  
 Volume/Flow Rate: 25 mL/50 mL/min  
 Signal Averaging: 1 Reading  
 Final Result Format: XXXXX

**Results:**

Titration Report  
 Method Name: 0.01N Sodium Hydroxide  
 Time & Date: 15:35 Jun 09, 2016  
 Titration ID: Ti\_00015

Titration Results  
 Method Name: 0.01N Sodium Hydroxide  
 Time & Date: 15:35 Jun 09, 2016  
 Analyte size: 0.01960 g  
 End Point Volume: 10.555 mL  
 pH Equivalence Point: 8.146  
 Results: 0.00909 N(eq/L)  
 Initial and Final pH: 4.987 to 8.640  
 Titration Duration: 7:02 [mm:ss]  
 Titration went to Completion  
 Operator name: \_\_\_\_\_

**Calculations:**

Calculations: Stdz. Titrant by Weight  
 Titrant units: N (eq/L)  
 Titrant volume dosed: V (L)  
 Standard weight: 2.000E-2 g  
 Titrant/Standard: 1.000 eq/mol  
 MW of standard: 204.23 g/mol

$$N \text{ (eq/L)} = \frac{2.000E-2 * 1.000}{204.23 * V(L)}$$

## 0.02N Iodine Titrant Concentration

### Description:

Method for the standardization (titer determination) of 0.02N Iodine (I<sub>2</sub>) titrant solution against Sodium Thiosulfate (Na<sub>2</sub>S<sub>2</sub>O<sub>3</sub>). The results are expressed in **N (eq/L)**.

### Reference:

Standard Methods for the Examination of Water and Wastewater 19<sup>th</sup> Edition, Method 4500-Cl C

### Electrode:

- HI3131B Combination ORP Electrode

### Reagents:

- HI70440 0.02N Stabilized Iodine (1 L)
- HI70403 Sodium Thiosulfate (20 g)
- HI70444 25% Sulfuric Acid (500 mL)
- HI70404 KI Powder Packets (100 pcs)
- HI70436 Deionized Water (1 gal)

### Accessories:

- HI70300L Storage Solution (500 mL)
- HI7071 Electrode Fill Solution (30 mL x 4)
- HI740036P 100-mL Plastic Beakers (10 pcs)
- Analytical Balance 0.0001 g
- 100-mL Class-A Volumetric Flask
- 10-mL Class-A Volumetric Pipette

### Device Preparation:

- Connect the ORP electrode to the titrator.
- Press "*Select Method*" from the main screen. Use the arrow keys to highlight 'HI0204EN 0.02N Iodine' and press "*Select*".
- Install a 25-mL burette filled with 0.02N stabilized iodine (HI70440) on pump-one and verify that no air bubbles are present in the burette or tubing. If necessary prime the burette until all the air has been removed completely.

### Electrode Preparation:

- Prepare the ORP electrode according to the procedure in the manual.

### Sample Preparation:

- Carefully weigh approximately 0.40 grams of sodium thiosulfate (HI70403).
- Record the exact weight of the sample once the balance has stabilized with an accuracy of 0.0001 grams.
- Carefully transfer the salt to a 100-mL class-A volumetric flask. Add approximately 80 mL of deionized water, and mix to dissolve. Once the salt is completely dissolved bring the flask to volume with deionized water, mix well.
- Use a class-A volumetric pipette to transfer exactly 10.00 mL of the solution to a clean 100-

mL plastic beaker. Add deionized water to the 50-mL mark on the beaker.

- Add 7 mL of 25% sulfuric acid (HI70444) and one HI70404 powder packet to the beaker.

### Analysis:

- Place the beaker under the stirrer assembly and lower it to immerse the ORP electrode and stirrer. Ensure that the reference junction of the ORP electrode is 5-6 mm below the surface. If necessary add extra deionized water.
- **NOTE:** The dispensing tip should be in contact with the surface of the sample (slightly submerged).
- Press "*Start*". You will be prompted to enter the analyte size (weight of sodium thiosulfate). Use the numeric keypad to enter the exact weight and press "*Enter*" to start the analysis.
- At the end of the titration, after detection of the equivalence point, 'titration complete' will appear with the titrant concentration. The result is expressed in **N (eq/L) iodine**.
- Remove the ORP electrode and stirrer from the sample and rinse them thoroughly with deionized water.
- Record the result.

**NOTE:** For improved accuracy, repeat this procedure a minimum of three times and calculate the average value.

**For methods utilizing 0.02N iodine titrant solution, follow the steps below to enter the titer/standardized value.**

- Select the method utilizing 0.02N iodine.
- Select "*Method Options*" from the main screen.
- Using the arrow keys, highlight 'Titrant Conc.' and press "*Select*".
- Use the numeric keypad to enter the standardized (titer) value of the titrant then press "*Accept*".
- Press "*Escape*" to exit the Method Options screen and select 'Save Method' option.

**0.02N Iodine Titrant Concentration****Method Parameters:**

Name: 0.02N Iodine  
 Method Revision: 3.0  
 Stirrer Configuration:  
 Stirrer: Stirrer 1  
 Stirrer Speed: 1400 RPM  
 Pump Configuration:  
 Titrant Pump: Pump 1  
 Dosing Type: Dynamic  
 min Vol: 0.050 mL  
 max Vol: 0.500 mL  
 delta E: 5.000 mV  
 End Point Mode: mV 1EQ point, 1st Dev  
 Recognition Options:  
 Threshold: 30 mV/mL  
 Range: NO  
 Filtered Derivatives: NO  
 Pre-Titration Volume: 5.000 mL  
 Pre-Titration Stir Time: 30 Sec  
 Measurement Mode: Signal Stability  
 delta E: 0.5 mV  
 delta t: 1.0 Sec  
 t-min wait: 2 Sec  
 t-max wait: 20 Sec  
 Electrode Type: ORP  
 Blank Option: No Blank  
 Calculations: Stdz. Titrant by Weight  
 Dilution Option: Enabled  
 Final Dilution Volume: 100.000 mL  
 Aliquot Volume: 10.000 mL  
 Titrant Name: 0.02N I2  
 Analyte Size: 0.4000 g  
 Analyte Entry: Manual  
 Maximum Titrant Volume: 15.000 mL  
 Potential Range: -2000.0 to 2000.0 mV  
 Volume/Flow Rate: 25 mL/50 mL/min  
 Signal Averaging: 1 Reading  
 Final Result Format: XXXXX

**Results:**

Titration Report  
 Method Name: 0.02N Iodine  
 Time & Date: 15:17 Jun 22, 2016  
 Titration ID: Ti\_00060

Titration Results  
 Method Name: 0.02N Iodine  
 Time & Date: 15:17 Jun 22, 2016  
 Analyte size: 0.45320 g  
 End Point Volume: 9.261 mL  
 mV Equivalence Point: 316.9  
 Results: 0.01972 N(eq/L)  
 Initial and Final mV: 212.2 to 375.2  
 Titration Duration: 3:34[mm:ss]  
 Titration went to Completion  
 Operator name: \_\_\_\_\_

**Calculations:**

Calculations: Stdz. Titrant by Weight  
 Titrant units: M (mol/L)  
 Titrant volume dosed: V (L)  
 Standard weight: 0.400 g  
 Dilution Factor: 0.100  
 Final Dilution volume: 100.000 mL  
 Aliquot Volume: 10.000 mL  
 Titrant/Standard: 1.000 eq/mol  
 MW of standard: 248.18 g/mol

$$M \text{ (mol/L)} = \frac{0.400 * 0.100 * 1.000}{248.18 * V(L)}$$



## Total Titratable Acidity in Wine, pH 7.00

### Description:

Method for the determination of total titratable acidity (TA) in wine, by titration of a 10-mL degassed sample to a fixed end point of pH 7.00. The results are expressed in **g/L of tartaric acid**.

### Reference:

AOAC International, Official Method 962.12 Acidity (Titratable) of Wines

### Electrode:

- HI1131B Combination pH Electrode
- HI7662-T Temperature Probe

### Reagents:

- HI 70456 0.1N Sodium Hydroxide (1 L)
- HI 70436 Deionized Water (1 gal)

### Other Accessories:

- HI70300L Storage Solution (500 mL)
- HI7071 Electrode Fill Solution (30 mL x 4)
- HI7004L pH 4.01 Buffer Solution (500 mL)
- HI7007L pH 7.01 Buffer Solution (500 mL)
- HI7010L pH 10.01 Buffer Solution (500 mL)
- HI740036P 100-mL Plastic Beakers (10 pcs)
- 10-mL Class-A Volumetric Pipette

### Device Preparation:

- Connect the pH electrode and temperature probe to the titrator.
- Press "*Select Method*" from the main screen. Use the arrow keys to highlight 'HI3204EN Titratable Acidity pH7.0' method and press "*Select*".
- Install a 25-mL burette with 0.1N sodium hydroxide (HI70456) on pump-one and verify that no air bubbles are present in the burette or tubing. If necessary prime the burette until all the air has been removed completely.  
For the determination of the exact concentration of the 0.1N sodium hydroxide, follow HI0001EN 0.1N Sodium Hydroxide Titrant Concentration.

### Electrode Preparation:

- Press "*Mode*" from the main screen and press "*pH*".
- Calibrate the electrode using pH 4.01, 7.01 and 10.01 buffers. Refer to the instruction manual for calibration procedure.

### Sample Preparation:

- Degas the wine sample to remove CO<sub>2</sub> by passing nitrogen through it, using an ultrasonic bath, or by stirring and applying vacuum. Degassing can also be achieved by boiling the wine for several seconds. The wine must be cooled to room temperature before it is used.

- Use a class-A volumetric pipette to transfer exactly 10.00 mL of degassed sample to a clean 100-mL plastic beaker. Add deionized water to the 50-mL mark on the beaker.

### Analysis:

- Place the beaker under the stirrer assembly and lower it to immerse the pH electrode, temperature probe and stirrer. Ensure that the reference junction of the pH electrode is 5-6 mm below the surface. If necessary add extra deionized water.  
**NOTE:** The dispensing tip should be in contact with the surface of the sample (slightly submerged).
- Press "*Start*". The titrator will start the analysis.
- At the end of titration, when pH 7.00 is reached, 'titration complete' will appear with the total titratable acidity concentration. The result is expressed in **g/L of tartaric acid**.
- Remove the pH electrode, temperature probe and stirrer from the sample and rinse them thoroughly with deionized water.
- Record the result.

**Total Titratable Acidity in Wine, pH 7.00****Method Parameters:**

Name: Titratable Acidity pH7.0  
 Method Revision: 3.0  
 Stirrer Configuration:  
 Stirrer: Stirrer 1  
 Stirring Speed: 1400 RPM  
 Pump Configuration:  
 Titrant Pump: Pump 1  
 Dosing Type: Dynamic  
 min Vol: 0.050 mL  
 max Vol: 0.800 mL  
 delta E: 8.000 mV  
 End Point Mode: Fixed 7.000 pH  
 Pre-Titration Volume: 3.000 mL  
 Pre-Titration Stir Time: 15 Sec  
 Measurement Mode: Signal Stability  
 delta E: 0.5 mV  
 delta t: 1.5 Sec  
 t-min wait: 2 Sec  
 t-max wait: 20 Sec  
 Electrode Type: pH  
 Blank Option: No Blank  
 Calculations: Sample Calc. by Volume  
 Dilution Option: Disabled  
 Titrant Name: 0.1N NaOH  
 Titrant Conc.: 0.1000 N (eq/L)  
 Analyte Size: 10.0000 mL  
 Analyte Entry: Fixed  
 Maximum Titrant Volume: 25.000 mL  
 Potential Range: -2000.0 to 2000.0 mV  
 Volume/Flow Rate: 25 mL/50 mL/min  
 Signal Averaging: 1 Reading  
 Final Result Format: XXX

**Calculations:**

Calculations: Sample Calc. by Volume  
 Titrant units: N (eq/L)  
 Titrant volume dosed: V (L)  
 Final result units: g/L  
 Titrant conc.: 0.100 N (eq/L)  
 Sample/Titrant: 0.500 mol/eq  
 MW of sample: 150.09 g/mol  
 Sample volume: 10.000 mL

$$\frac{\text{g}}{\text{L}} = \frac{V(\text{L}) * 0.100 * 0.5 * 150.09 * 1000}{10.000}$$

**Results:**

Titration Report  
 Method Name: Titratable Acidity pH7.0  
 Time & Date: 11:15 Aug 05, 2016  
 Titration ID: Ti\_00011

Titration Results  
 Method Name: Titratable Acidity pH7.0  
 Time & Date: 11:15 Aug 05, 2016  
 Analyte size: 10.000 mL  
 End Point Volume: 7.273 mL  
 pH Fixed End Point: 7.000  
 Results: 5.15 g/L  
 Initial and Final pH: 3.273 to 7.049  
 Titration Duration: 2:40 [mm:ss]  
 Titration went to Completion  
 Operator name: \_\_\_\_\_

## Total Titratable Acidity in Wine, pH 8.20

### Description:

Method for the determination of total titratable acidity (TA) in wine, by titration of a 10-mL degassed sample to a fixed end point of pH 8.20. The results are expressed in **g/L of tartaric acid**.

### Reference:

AOAC International, Official Method 962.12 Acidity (Titratable) of Wines

### Electrode:

- HI1131B Combination pH Electrode
- HI7662-T Temperature Probe

### Reagents:

- HI70456 0.1N Sodium Hydroxide (1 L)
- HI70436 Deionized Water (1 gal)

### Other Accessories:

- HI70300L Storage Solution (500 mL)
- HI7071 Electrode Fill Solution (30 mL x 4)
- HI7004L pH 4.01 Buffer Solution (500 mL)
- HI7007L pH 7.01 Buffer Solution (500 mL)
- HI7010L pH 10.01 Buffer Solution (500 mL)
- HI740036P 100-mL Plastic Beakers (10 pcs)
- 10-mL Class-A Volumetric Pipette

### Device Preparation:

- Connect the pH electrode and temperature probe to the titrator.
- Press "*Select Method*" from the main screen. Use the arrow keys to highlight 'HI3205EN Titratable Acidity pH8.2' method and press "*Select*".
- Install a 25-mL burette with 0.1N sodium hydroxide (HI70456) on pump-one and verify that no air bubbles are present in the burette or tubing. If necessary prime the burette until all the air has been removed completely.  
For the determination of the exact concentration of the 0.1N sodium hydroxide, follow HI0001EN 0.1N Sodium Hydroxide Titrant Concentration.

### Electrode Preparation:

- Press "*Mode*" from the main screen and press "*pH*".
- Calibrate the electrode using pH 4.01, 7.01 and 10.01 buffers. Refer to the instruction manual for calibration procedure.

### Sample Preparation:

- Degas the wine sample to remove CO<sub>2</sub> by passing nitrogen through it, using an ultrasonic bath, or by stirring and applying vacuum. Degassing can also be achieved by boiling the wine for several seconds. The wine must be cooled to room temperature before it is used.

- Use a class-A volumetric pipette to transfer exactly 10.00 mL of degassed sample to a clean 100-mL plastic beaker. Add deionized water to the 50-mL mark on the beaker.

### Analysis:

- Place the beaker under the stirrer assembly and lower it to immerse the pH electrode, temperature probe and stirrer. Ensure that the reference junction of the pH electrode is 5-6 mm below the surface. If necessary add extra deionized water.  
**NOTE:** The dispensing tip should be in contact with the surface of the sample (slightly submerged).
- Press "*Start*". The titrator will start the analysis.
- At the end of titration, when pH 8.20 is reached, 'titration complete' will appear with the total titratable acidity concentration. The result is expressed in **g/L of tartaric acid**.
- Remove the pH electrode, temperature probe and stirrer from the sample and rinse them thoroughly with deionized water.
- Record the result.

**Total Titratable Acidity in Wine, pH 8.20****Method Parameters:**

Name: Titratable Acidity pH8.2  
 Method Revision: 3.0  
 Stirrer Configuration:  
 Stirrer: Stirrer 1  
 Stirring Speed: 1400 RPM  
 Pump Configuration:  
 Titrant Pump: Pump 1  
 Dosing Type: Dynamic  
 min Vol: 0.050 mL  
 max Vol: 0.800 mL  
 delta E: 8.000 mV  
 End Point Mode: Fixed 8.200 pH  
 Pre-Titration Volume: 3.000 mL  
 Pre-Titration Stir Time: 15 Sec  
 Measurement Mode: Signal Stability  
 delta E: 0.5 mV  
 delta t: 1.5 Sec  
 t-min wait: 2 Sec  
 t-max wait: 20 Sec  
 Electrode Type: pH  
 Blank Option: No Blank  
 Calculations: Sample Calc. by Volume  
 Dilution Option: Disabled  
 Titrant Name: 0.1N NaOH  
 Titrant Conc.: 0.1000 N (eq/L)  
 Analyte Size: 10.0000 mL  
 Analyte Entry: Fixed  
 Maximum Titrant Volume: 25.000 mL  
 Potential Range: -2000.0 to 2000.0 mV  
 Volume/Flow Rate: 25 mL/50 mL/min  
 Signal Averaging: 1 Reading  
 Final Result Format: XXX

**Calculations:**

Calculations: Sample Calc. by Volume  
 Titrant units: N (eq/L)  
 Titrant volume dosed: V (L)  
 Final result units: g/L  
 Titrant conc.: 0.100 N (eq/L)  
 Sample/Titrant: 0.500 mol/eq  
 MW of sample: 150.09 g/mol  
 Sample volume: 10.000 mL  

$$\text{g/L} = \frac{V(\text{L}) * 0.10000 * 0.5 * 150.09 * 1000}{10.000}$$

**Results:**

Titration Report  
 Method Name: Titratable Acidity pH8.2  
 Time & Date: 14:49 Sep 21, 2016  
 Titration ID: Ti\_00046

Titration Results  
 Method Name: Titratable Acidity pH8.2  
 Time & Date: 14:49 Sep 21, 2016  
 Analyte size: 10.000 mL  
 End Point Volume: 7.915 mL  
 pH Fixed End Point: 8.2000  
 Results: 5.64 g/L  
 Initial and Final pH: 3.472 to 8.293  
 Titration Duration: 4:08 [mm:ss]  
 Titration went to Completion  
 Operator name: \_\_\_\_\_

## Volatile Acidity in Wine

### Description:

Method for the determination of volatile acidity in wine, by titration of a distillate that is collected from a steam distillation apparatus (Volatile Acid / Cash Still). The results are expressed in **g/L of acetic acid**.

Sulfur Dioxide interferences are eliminated by addition of hydrogen peroxide prior to the steam distillation.

### Reference:

Wine Analysis and Production Acetic Acid: Steam Distillation of Volatile Acid using Still

### Electrode:

- HI1131B Combination pH Electrode
- HI7662-T Temperature Probe

### Reagents:

- HI70456 0.1N Sodium Hydroxide (1 L)
- HI70432 3% Hydrogen Peroxide (25 mL)
- HI70436 Deionized Water (1 gal)

### Other Accessories:

- HI70300L Storage Solution (500 mL)
- HI7071 Electrode Fill Solution (30 mL x 4)
- HI7004L pH 4.01 Buffer Solution (500 mL)
- HI7007L pH 7.01 Buffer Solution (500 mL)
- HI7010L pH 10.01 Buffer Solution (500 mL)
- Volatile Acid (Cash) Still
- 10-mL Class-A Volumetric Pipette
- 150-mL Glass Beaker

### Device Preparation:

- Connect the pH electrode and temperature probe to the titrator.
- Press "*Select Method*" from the main screen. Use the arrow keys to highlight the 'HI3208EN Volatile Acidity' method and press "*Select*".
- Install the 25-mL burette with 0.1N sodium hydroxide (HI70456) on pump-one and verify that no air bubbles are present in the burette or tubing. If necessary prime the burette until all air has been removed completely.

For the determination of the exact concentration of the 0.1N sodium hydroxide, follow the HI0001EN 0.1N Sodium Hydroxide Titrant Concentration.

### Electrode Device:

- Press "*Mode*" from the main screen and press "*pH*".
- Calibrate the electrode using pH 4.01, 7.01 and 10.01 buffers. Refer to the instruction manual for calibration procedure.

### Sample Preparation:

- Use the class-A volumetric pipette to transfer exactly 10.00 mL of degassed sample to the distillation flask. Add 0.5 mL of 3% hydrogen peroxide (HI70432). Steam distill the sample until approximately 100 mL of distillate has been collected in the 150-mL glass beaker.

### Analysis:

- Place the beaker under the stirrer assembly and lower it to immerse the pH electrode, temperature probe and stirrer. Ensure that the reference junction of the pH electrode is 5-6 mm below the surface. If necessary add extra deionized water.  
**NOTE:** The dispensing tip should be in contact with the surface of the sample (slightly submerged).
- Press "*Start*". The titrator will start the analysis.
- At the end of titration, when pH 8.20 is reached, 'titration completed' will appear with the volatile acidity concentration. The result is expressed in **g/L of acetic acid**.
- Remove the pH electrode, temperature probe and stirrer from the sample and rinse them thoroughly with deionized water.
- Record the result.

**Volatile Acidity in Wine****Method Parameters:**

Name: Volatile Acidity  
 Method Revision: 3.0  
 Stirrer Configuration:  
 Stirrer: Stirrer 1  
 Stirring Speed: 1400 RPM  
 Pump Configuration:  
 Titrant Pump: Pump 1  
 Dosing Type: Dynamic  
 min Vol: 0.010 mL  
 max Vol: 0.100 mL  
 delta E: 6.000 mV  
 End Point Mode: Fixed 8.200 pH  
 Pre-Titration Volume: 0.000 mL  
 Pre-Titration Stir Time: 20 Sec  
 Measurement Mode: Signal Stability  
 delta E: 0.5 mV  
 delta t: 1.6 Sec  
 t-min wait: 2 Sec  
 t-max wait: 20 Sec  
 Electrode Type: pH  
 Blank Option: No Blank  
 Calculations: Sample Calc. by Volume  
 Dilution Option: Disabled  
 Titrant Name: 0.01N NaOH  
 Titrant Conc.: 1.0000E-2 N (eq/L)  
 Analyte Size: 10.000 mL  
 Analyte Entry: Fixed  
 Maximum Titrant Volume: 25.000 mL  
 Potential Range: -2000.0 to 2000.0 mV  
 Volume/Flow Rate: 25 mL/50 mL/min  
 Signal Averaging: 3 Readings  
 Final Result Format: XXX

**Calculations:**

Calculations: Sample Calc. by Volume  
 Titrant units: N (eq/L)  
 Titrant volume dosed: V L)  
 Final result units: g/L  
 Titrant conc.: 1.0000E-2 eq/L  
 Sample/Titrant: 1.000 mol/eq  
 MW of sample: 60.050 g/mol  
 Sample volume: 10.000 mL

$$\frac{\text{g}}{\text{L}} = \frac{V(\text{L}) * 1.0000\text{E-}2 * 1.0 * 60.05 * 1000}{10.000}$$

**Results:**

Titration Report  
 Method Name: Volatile Acid  
 Time & Date: 12:43 Mar 28, 2018  
 Titration ID: Ti\_00009

Titration Results  
 Method Name: Volatile Acid  
 Time & Date: 12:43 Mar 28, 2018  
 Analyte size: 10.000 mL  
 End Point Volume: 0.402 mL  
 pH Fixed End Point: 8.200  
 Results: 0.024 g/L  
 Initial and Final pH: 5.534 to 8.204  
 Titration Duration: 9:12 [mm:ss]  
 Titration went to Completion  
 Operator name: \_\_\_\_\_

## Free Sulfur Dioxide

### Orienting Ripper Method

**Description:**

Method for the determination of free sulfur dioxide (SO<sub>2</sub>) in wine, following the Orienting Ripper Method. The result is expressed in **ppm (mg/L) of sulfur dioxide**.

**Reference:**

Wine Analysis and Production Sulfur Dioxide: Ripper Titrametric Method Using Iodine

**Electrode:**

- HI3131B Combination ORP electrode

**Primary Reagents:**

- HI70440 0.02N Stabilized Iodine (1 L)
- HI70444 25% Sulfuric Acid (500 mL)
- HI70404 KI Powder Packets (100 pcs)
- HI70436 Deionized Water (1 gal)

**Other Accessories:**

- HI70300L Storage Solution (500 mL)
- HI7071 Electrode Filling Solution (30 mL x 4)
- HI740036 100-mL Plastic Beakers (10 pcs)
- 50-mL Class-A Pipette

**Device Preparation:**

- Connect the ORP electrode to the titrator.
- Press "*Select Method*" from the main screen. Use the arrow keys to highlight the 'HI3213EN Free Sulfur Dioxide' method and press "*Select*".
- Install a 25-mL burette with 0.02N iodine (HI70440) on pump-one and verify that no air bubbles are present in the burette or tubing. If necessary prime the burette until all the air has been removed completely.  
For the determination of the exact concentration of the 0.02N iodine, follow HI0204EN 0.02N Iodine Titrant Concentration.

**Electrode Preparation:**

- Prepare the ORP electrode according to the procedure in the manual.

**Sample Preparation:**

- Use a class-A glass pipette to transfer exactly 50.00 mL of wine to a clean 100-ml plastic beaker.
- Add 5 to 7 mL of 25% sulfuric acid (HI70444) and one HI70404 powder packet.

**Analysis:**

- Place the beaker under the stirrer assembly and lower it to immerse the ORP electrode and stirrer. Ensure that the reference junction of the ORP electrode is 5-6 mm below the surface.

**NOTE:** The dispensing tip should be in contact with the surface of the sample (slightly submerged).

- Press "*Start*". The titrator will start the analysis.
- At the end of titration, when the equivalence point is reached, 'titration complete' will appear with the sulfur dioxide concentration. The result is expressed in **ppm (mg/L) of sulfur dioxide**.
- Remove the ORP electrode and stirrer from the sample and rinse them thoroughly with deionized water.
- Record the result.

## Free Sulfur Dioxide

### Orienting Ripper Method

**Method Parameters:**

Name: Free Sulfur Dioxide  
 Method Revision: 3.0  
 Stirrer Configuration:  
   Stirrer: Stirrer 1  
   Stirring Speed: 1400 RPM  
 Pump Configuration:  
   Titrant Pump: Pump 1  
 Dosing Type: Dynamic  
   min Vol: 0.015 mL  
   max Vol: 0.200 mL  
   delta E: 0.800 mV  
 End Point Mode: mV 1EQ point, 1st Der  
 Recognition Options:  
   Threshold: 200 mV/mL  
   Range: NO  
   Filtered Derivatives: NO  
 Pre-Titration Volume: 0.000 mL  
 Pre-Titration Stir Time: 30 Sec  
 Measurement Mode: Signal Stability  
   delta E: 1.0 mV  
   delta t: 3.0 Sec  
   t-min wait: 5 Sec  
   t-max wait: 45 Sec  
 Electrode Type: ORP  
 Blank Option: No Blank  
 Calculations: Sample Calc. by Volume  
 Dilution Option: Disabled  
 Titrant Name: 0.02N Iodine  
 Titrant Conc.: 2.0000E-2 N (eq/L)  
 Analyte Size: 50.000 mL  
 Analyte Entry: Fixed  
 Maximum Titrant Volume: 25.000 mL  
 Stirring Speed: 1400 rpm  
 Potential Range: -2000.0 to 2000.0 mV  
 Volume/Flow Rate: 25 mL/50 mL/min  
 Signal Averaging: 2 Readings  
 Final Result Format: XXXX

**Calculations:**

Calculations: Sample Calc. by Volume  
 Titrant units: N (eq/L)  
 Titrant volume dosed: V L)  
 Final result units: ppm (mg/L)  
 Titrant conc.: 2.000E-2 eq/L  
 Sample/Titrant: 0.500 mol/eq  
 MW of sample: 64.063 g/mol  
 Sample volume: 50.000 mL

$$\text{ppm} = \frac{V(L) * 1000 * 0.02 * 0.5 * 64.063}{0.050}$$

**Results:**

Titration Report

Method Name: Free Sulfur Dioxide  
 Time & Date: 13:44 Feb 16, 2017  
 Titration ID: Ti\_00013

Titration Results

Method Name: Report

Method Name: Free Sulfur Dioxide  
 Time & Date: 13:44 Feb 16, 2017  
 Analyte size: 50.000 mL  
 End Point Volume: 1.225 mL  
 pH Equivalence Point: 254.4  
 Results: 15.36 ppm (mg/L)  
 Initial and Final mV: 2361.1 to 315.3  
 Titration Duration: 1:39 [mm:ss]  
 Titration went to Completion  
 Operator name: \_\_\_\_\_



## Total Sulfur Dioxide

### Orienting Ripper Method

**Description:**

Method for the determination of total sulfur dioxide (SO<sub>2</sub>) in wine, following the Orienting Ripper Method. The result is expressed in **ppm (mg/L) of sulfur dioxide**.

**Reference:**

Wine Analysis and Production Sulfur Dioxide: Ripper Titrametric Method Using Iodine

**Electrode:**

- HI3131B Combination ORP electrode

**Primary Reagents:**

- HI70440 0.02N Stabilized Iodine (1 L)
- HI70435 5M Sodium Hydroxide (500 mL)
- HI70444 25% Sulfuric Acid (500 mL)
- HI70404 KI Powder Packets (100 pcs)
- HI70436 Deionized Water (1 gal)

**Other Accessories:**

- HI70300L Storage Solution (500 mL)
- HI7071 Electrode Filling Solution (30 mL x 4)
- HI740036 100-mL Plastic Beakers (10 pcs)
- 50-mL Class-A Pipette

**Device Preparation:**

- Connect the ORP electrode to the titrator.
- Press "*Select Method*" from the main screen. Use the arrow keys to highlight the 'HI3216EN Total Sulfur Dioxide' method and press "*Select*".
- Install a 25-mL burette with 0.02N iodine (HI70440) on pump-one and verify that no air bubbles are present in the burette or tubing. If necessary prime the burette until all the air has been removed completely.  
For the determination of the exact concentration of the 0.02N iodine, follow HI0204EN 0.02N Iodine Titrant Concentration.

**Electrode Preparation:**

- Prepare the ORP electrode according to the procedure in the manual.

**Sample Preparation:**

- Use a class-A glass pipette to transfer exactly 50.00 mL of wine to a clean 100-ml plastic beaker.
- Add 5 mL of 5M sodium hydroxide (HI70435). Cover the beaker and swirl. Allow the sample to sit for approximately 20 minutes.
- Add 10 mL of 25% sulfuric acid (HI70444) and one HI70404 powder packet.

**Analysis:**

- Place the beaker under the stirrer assembly and lower it to immerse the ORP electrode and stirrer. Ensure that the reference junction of the ORP electrode is 5-6 mm below the surface.
- **NOTE:** The dispensing tip should be in contact with the surface of the sample (slightly submerged).
- Press "*Start*". The titrator will start the analysis.
- At the end of titration, when the equivalence point is reached, 'titration complete' will appear with the sulfur dioxide concentration. The result is expressed in **ppm (mg/L) of sulfur dioxide**.
- Remove the ORP electrode and stirrer from the sample and rinse them thoroughly with deionized water.
- Record the result.

## Total Sulfur Dioxide

### Orienting Ripper Method

**Method Parameters:**

Name: Total Sulfur Dioxide  
 Method Revision: 3.0  
 Stirrer Configuration:  
 Stirrer: Stirrer 1  
 Stirring Speed: 1400 RPM  
 Pump Configuration:  
 Titrant Pump: Pump 1  
 Dosing Type: Dynamic  
 min Vol: 0.020 mL  
 max Vol: 0.400 mL  
 delta E: 2.500 mV  
 End Point Mode: mV 1EQ point, 1st Der  
 Recognition Options:  
 Threshold: 50 mV/mL  
 Range: NO  
 Filtered Derivatives: YES  
 Pre-Titration Volume: 0.000 mL  
 Pre-Titration Stir Time: 30 Sec  
 Measurement Mode: Signal Stability  
 delta E: 0.5 mV  
 delta t: 2.0 Sec  
 t-min wait: 2 Sec  
 t-max wait: 20 Sec  
 Electrode Type: ORP  
 Blank Option: No Blank  
 Calculations: Sample Calc. by Volume  
 Dilution Option: Disabled  
 Titrant Name: 0.02N Iodine  
 Titrant Conc.: 2.0000E-2 N (eq/L)  
 Analyte Size: 50.000 mL  
 Analyte Entry: Fixed  
 Maximum Titrant Volume: 25.000 mL  
 Stirring Speed: 1400 rpm  
 Potential Range: -2000.0 to 2000.0 mV  
 Volume/Flow Rate: 25 mL/50 mL/min  
 Signal Averaging: 3 Readings  
 Final Result Format: XXXX

**Results:**

Titration Report

Method Name: Total Sulfur Dioxide  
 Time & Date: 14:40 Feb 20, 2016  
 Titration ID: Ti\_00123

Titration Results

Method Name: Total Sulfur Dioxide  
 Time & Date: 14:40 Feb 20, 2016  
 Analyte size: 50.000 mL  
 End Point Volume: 4.290 mL  
 pH Equivalence Point: 261.6  
 Results: 54.40 ppm (mg/L)  
 Initial and Final mV: 253.7 to 281.8  
 Titration Duration: 4:53 [mm:ss]  
 Titration went to Completion  
 Operator name: \_\_\_\_\_

**Calculations:**

Calculations: Sample Calc. by Volume  
 Titrant units: N (eq/L)  
 Titrant volume dosed: V L)  
 Final result units: ppm (mg/L)  
 Titrant conc.: 2.000E-2 eq/L  
 Sample/Titrant: 0.500 mol/eq  
 MW of sample: 64.063 g/mol  
 Sample volume: 50.000 mL

$$\text{ppm} = \frac{V(L) * 1000 * 0.02 * 0.5 * 64.063}{0.050}$$

## Reducing Sugar - Blank

### Description:

Method for the determination of reducing sugar in wine. An excess of copper(II) is added to a sample and upon heating, the reducing sugars present in the sample reduce the copper(II) to copper(I). Potassium iodide is added to the sample and reacts with the remaining excess copper(II) to form iodine. The iodine is titrated with sodium thiosulfate.

A blank titration is performed to quantify and correct for the other constituents in wine that react with the Fehling reagent and therefore, decrease copper.

The reduction of copper(II) is neither stoichiometric nor linear, thus a calibration factor must be determined to standardize the correlation between copper(II) and reducing sugar.

This analysis involves a three-part procedure to determine the blank, the calibration factor, and finally the concentration of reducing sugars. This method, HI3217EN, is used to determine the blank value. The result is expressed as **L of titrant**.

### Reference:

Zoecklein, et al. Wine Analysis and Production. Reducing Sugars: Titrametric-Rebelein (Gold Coast) Method

### Electrode:

- HI3131B Combination ORP Electrode

### Reagents:

- HI70439 0.1M Sodium Thiosulfate (1 L)
- HI70446 Fehling A (500 mL)
- HI70447 Fehling B (500 mL)
- HI70425 16% Sulfuric Acid (500 mL)
- HI70437 Concentrated KI (500 mL)
- HI70436 Deionized Water (1 gal)

### Other Accessories:

- HI70300L Storage Solution (500 mL)
- HI7071 Electrode Fill Solution (30 mL x 4)
- HI731342 2000 $\mu$ L Automatic Pipette
- HI731352 2000 $\mu$ L Automatic Pipette Tips (4pcs)
- 150-mL Glass Beaker
- 5-mL Class-A pipette
- 10-mL Class-A pipette
- Hot Plate

### Device Preparation:

- Connect the ORP electrode to the titrator.
- Press "*Select Method*" from the main screen. Use the arrow keys to highlight 'HI3217EN Reducing Sugar - Blank' method and press "*Select*".
- Install a 25-mL burette with 0.1M sodium thiosulfate (HI70439) on pump-one and verify that no air bubbles are present in the burette or tubing. If necessary prime the burette until all the air has been removed completely.

For the determination of the exact concentration of the 0.1M sodium thiosulfate, follow HI0003EN 0.1M Sodium Thiosulfate Titrant Concentration.

### Electrode Preparation:

- Prepare the ORP electrode according to the procedure in the manual.

### Sample Preparation:

- Add 2000  $\mu$ L of deionized water to a 150-mL glass beaker using the automatic pipette.
- Use a class-A volumetric pipette to transfer exactly 5.00 mL of Fehling A (HI70446) and exactly 5.00 mL of Fehling B (HI70447) to the 150-mL glass beaker
- Heat the mixture to a boil for approximately 2 minutes.
- Cool the solution to room temperature by running the beaker under tap water or submersing the bottom of the beaker in a water bath.
- Use a class-A volumetric pipette to transfer exactly 10.00 mL of concentrated potassium iodide (HI70437) to the 150-mL glass beaker.
- Use a class-A volumetric pipette to transfer exactly 10.00 mL of 16% sulfuric acid (HI70425) to the 150-mL glass beaker.
- Add approximately 70 mL of deionized water to bring the total volume to 100 mL.

### Analysis:

- Place the beaker under the stirrer assembly and lower it to immerse the ORP electrode and stirrer. Ensure that the reference junction of the ORP electrode is 5-6 mm below the surface. If necessary add extra deionized water.

**NOTE:** The dispensing tip should be in contact with the surface of the sample (slightly submerged).

- Press "*Start*". The titrator will start the analysis.
- At the end of titration, when the equivalence point is reached, 'titration complete' will appear with the result. The result is expressed in **L of titrant**
- Remove the ORP electrode and stirrer from the sample and rinse them thoroughly with deionized water.
- Record the result.

**Reducing Sugar - Blank****Method Parameters:**

Name: Reducing Sugar - Blank  
 Method Revision: 3.0  
 Stirrer Configuration:  
 Stirrer: Stirrer 1  
 Stirring Speed: 1400 RPM  
 Pump Configuration:  
 Titrant Pump: Pump 1  
 Dosing Type: Dynamic  
 min Vol: 0.020 mL  
 max Vol: 0.500 mL  
 delta E: 6.500 mV  
 End Point Mode: mV 1 EQ Point, 1st Der  
 Recognition Options:  
 Threshold: 75 mV/mL  
 Range: NO  
 Filtered Derivatives: YES  
 Pre-Titration Volume: 10.000 mL  
 Pre-Titration Stir Time: 30 Sec  
 Measurement Mode: Signal Stability  
 delta E: 0.5 mV  
 delta t: 2.5 Sec  
 t-min wait: 3 Sec  
 t-max wait: 20 Sec  
 Electrode Type: ORP  
 Blank Option: No Blank  
 Calculations: No Formula (L only)  
 Titrant Name: 0.1M Na2S2O3  
 Maximum Titrant Volume: 20.000 mL  
 Potential Range: -2000.0 to 2000.0 mV  
 Volume/Flow Rate: 25 mL/50 mL/min  
 Signal Averaging: 2 Readings  
 Final Result Format: XXXX

**Results:**

Titration Report  
 Method Name: Reducing Sugar - Blank  
 Time & Date: 9:52 Dec 20, 2016  
 Titration ID: Ti\_00048

Titration Results  
 Method Name: Reducing Sugar - Blank  
 Time & Date: 9:52 Dec 20, 2016  
 End Point Volume: 0.01228 L  
 mV Equivalence Point: 221.2  
 Results: 0.01228 L  
 Initial and Final mV: 353.1 to 174.4  
 Titration Duration: 3:32 [mm:ss]  
 Titration went to Completion  
 Operator name: \_\_\_\_\_

**Calculations:**

Final Results unit in L

V = volume dispensed in liters

## Reducing Sugar - Calibration Factor

### Description:

Method for the determination of reducing sugar in wine. An excess of copper(II) is added to a sample and upon heating, the reducing sugars present in the sample reduce the copper(II) to copper(I). Potassium iodide is added to the sample and reacts with the remaining excess copper(II) to form iodine. The iodine is titrated with sodium thiosulfate.

A blank titration is performed to quantify and correct for the other constituents in wine that react with the Fehling reagent and therefore, decrease copper.

The reduction of copper(II) is neither stoichiometric nor linear, thus a calibration factor must be determined to standardize the correlation between copper(II) and reducing sugar.

This analysis involves a three-part procedure to determine the blank, the calibration factor, and finally the concentration of reducing sugars. This method, HI3218EN, is used to determine the calibration factor. The result is expressed as **g/L of reducing sugar**.

### Reference:

Zoecklein, et al. Wine Analysis and Production.  
Reducing Sugars: Titrametric-Rebelein (Gold Coast) Method

### Electrode:

- HI3131B Combination ORP Electrode

### Reagents:

- HI70439 0.1M Sodium Thiosulfate (1 L)
- HI70446 Fehling A (500 mL)
- HI70447 Fehling B (500 mL)
- HI70425 16% Sulfuric Acid (500 mL)
- HI70437 Concentrated KI (500 mL)
- HI70436 Deionized Water (1 gal)

### Other Accessories:

- HI70300L Storage Solution (500 mL)
- HI7071 Electrode Fill Solution (30 mL x 4)
- HI731342 2000 $\mu$ L Automatic Pipette
- HI731352 2000 $\mu$ L Automatic Pipette Tips (4pcs)
- 150-mL Glass Beaker
- 100-mL Class-A Volumetric Flask
- 5-mL Class-A Pipette
- 10-mL Class-A Pipette
- Hot Plate
- Analytical Balance with 0.0001g resolution
- 10 g Glucose Standard
- 20 g Glucose Standard

### Device Preparation:

- Connect the ORP electrode to the titrator.
- Press "*Select Method*" from the main screen. Use the arrow keys to highlight 'HI3218EN Reducing Sugar – Cal.' method and press "*Select*".

- Install a 25-mL burette with 0.1M sodium thiosulfate (HI70439) on pump-one and verify that no air bubbles are present in the burette or tubing. If necessary prime the burette until all the air has been removed completely.

For the determination of the exact concentration of the 0.1M sodium thiosulfate, follow HI0003EN 0.1M Sodium Thiosulfate Titrant Concentration.

- Update the blank value. Press "*Method Options*" from the main screen. Use the arrow keys to highlight 'Blank Value' and press "*Select*". Use the numeric keypad to enter the blank value obtained from HI3217 Reducing Sugar – Blank and press "*Accept*". Press "*Escape*" to exit the Method Options screen and select 'Save Method' option.

### Electrode Preparation:

- Prepare the ORP electrode according to the procedure in the manual.

### Glucose Standard Preparation:

- 10 g Glucose Standard – Weigh 1.0 g of glucose, transfer to 100-mL class-A volumetric flask. Add deionized water to dissolve, bring to volume, cap and mix. This solution is not stable and should not be made in advance.
- 20 g Glucose Standard – Weigh 2.0 g of glucose, transfer to 100-mL class-A volumetric flask. Add deionized water to dissolve, bring to volume, cap and mix. This solution is not stable and should not be made in advance.

### Sample Preparation:

- Add 2000 $\mu$ L of 10 g/L glucose standard to a 150-mL glass beaker using the automatic pipette.
- Use a class-A volumetric pipette to transfer exactly 5.00 mL of Fehling A (HI70446) and exactly 5.00 mL of Fehling B (HI70447) to the 150-mL glass beaker
- Heat the mixture to a boil for approximately 2 minutes.
- Cool the solution to room temperature by running the beaker under tap water or submersing the bottom of the beaker in a water bath.
- Use a class-A volumetric pipette to transfer exactly 10.00 mL of concentrated potassium iodide (HI70437) to the 150-mL beaker.
- Use a class-A volumetric pipette to transfer exactly 10.00 mL of 16% sulfuric acid (HI70425) to the 150-mL beaker.
- Add approximately 70 mL of deionized water to bring the total volume to 100 mL.
- Repeat this procedure with the 20 g/L glucose standard.

## Reducing Sugar - Calibration Factor

### Analysis:

- Place the beaker under the stirrer assembly and lower it to immerse the ORP electrode and stirrer. Ensure that the reference junction of the ORP electrode is 5-6 mm below the surface. If necessary add extra deionized water.  
**NOTE:** The dispensing tip should be in contact with the surface of the sample (slightly submerged).
- Press "*Start*". The titrator will start the analysis.
- At the end of titration, when the equivalence point is reached, 'titration complete' will appear with the result. The result is expressed as **g/L reducing sugar**.
- Remove the ORP electrode and stirrer from the sample and rinse them thoroughly with deionized water.
- Record the result.
- Repeat this procedure with the 20 g/L glucose standard.

### Calibration Factor:

The Calibration factor is determined by dividing concentration of the standard by the titrated value. These values are then added together and divided by 2.

Example:

10 g/L Glucose Standard titrated as 11.24 g/L:

$$\frac{10.00}{11.24} = 0.8897$$

20 g/L Glucose Standard titrated as 21.74 g/L:

$$\frac{20.00}{21.74} = 0.9199$$

Calibration Factor:

$$\frac{(0.8897 + 0.9199)}{2} = 0.9048$$

**Reducing Sugar - Calibration Factor****Method Parameters:**

Name: Reducing Sugar - Cal.  
 Method Revision: 3.0  
 Stirrer Configuration:  
 Stirrer: Stirrer 1  
 Stirring Speed: 1400 RPM  
 Pump Configuration:  
 Titrant Pump: Pump 1  
 Dosing Type: Dynamic  
 min Vol: 0.020 mL  
 max Vol: 0.500 mL  
 delta E: 6.500 mV  
 End Point Mode: mV 1 EQ Point, 1st Der  
 Recognition Options:  
 Threshold: 75 mV/mL  
 Range: NO  
 Filtered Derivatives: YES  
 Pre-Titration Volume: 0.000 mL  
 Pre-Titration Stir Time: 30 Sec  
 Measurement Mode: Signal Stability  
 delta E: 0.5 mV  
 delta t: 2.5 Sec  
 t-min wait: 3 Sec  
 t-max wait: 20 Sec  
 Electrode Type: ORP  
 Blank Option: Blank - V  
 Blank Value: 1.2500E-2 L  
 Calculations: Generic Formula  
 Dilution Option: Disabled  
 Titrant Name: 0.1M Na2S2O3  
 Titrant Conc.: 0.1000 C  
 Analyte Size: 2.0000 mL  
 Analyte Entry: Fixed  
 Maximum Titrant Volume: 20.000 mL  
 Potential Range: -2000.0 to 2000.0 mV  
 Volume/Flow Rate: 25 mL/50 mL/min  
 Signal Averaging: 2 Readings  
 Final Result Format: XXXX

**Calculations:**

Calculations: Generic Formula  
 Titrant volume dosed: V (L)  
 Final result units: g/L  
 Titrant conc.: 0.100 C  
 Blank Volume: 1.250E-2 L  
 Factor 1: 36.000  
 Factor 2: 1.0000E3  
 Factor 3: 1.000  
 Sample size: 2.000  

$$\text{g/L} = \frac{(1.250\text{E}-2 - V(\text{L})) * 0.10 * 36.0 * 1.0\text{E}3 * 1.0}{2.000}$$

**Results (10 g/L Glucose Standard):**

Titration Report  
 Method Name: Reducing Sugar - Cal.  
 Time & Date: 11:39 Dec 20, 2016  
 Titration ID: Ti\_00037

Titration Results  
 Method Name: Reducing Sugar - Cal.  
 Time & Date: 11:39 Dec 20, 2016  
 Analyte Size: 2.000 mL  
 End Point Volume: 6.792 mL  
 mV Equivalence Point: 205.1  
 Results: 21.74 g/L  
 Initial and Final mV: 332.2 to 168.9  
 Titration Duration: 6:45 [mm:ss]  
 Titration went to Completion  
 Operator name: \_\_\_\_\_

**Results (20 g/L Glucose Standard):**

Titration Report  
 Method Name: Reducing Sugar - Cal.  
 Time & Date: 12:04 Dec 20, 2016  
 Titration ID: Ti\_00053

Titration Results  
 Method Name: Reducing Sugar - Cal.  
 Time & Date: 12:04 Dec 20, 2016  
 Analyte Size: 2.000 mL  
 End Point Volume: 0.959 mL  
 mV Equivalence Point: 217.5  
 Results: 21.74 g/L  
 Initial and Final mV: 312.8 to 170.3  
 Titration Duration: 3:28 [mm:ss]  
 Titration went to Completion  
 Operator name: \_\_\_\_\_





## Reducing Sugar in Wine

### Description:

Method for the determination of reducing sugar in wine. An excess of copper(II) is added to a sample and upon heating, the reducing sugars present in the sample reduce the copper(II) to copper(I). Potassium iodide is added to the sample and reacts with the remaining excess copper(II) to form iodine. The iodine is titrated with sodium thiosulfate.

A blank titration is performed to quantify and correct for the other constituents in wine that react with the Fehling reagent and therefore, decrease copper.

The reduction of copper(II) is neither stoichiometric nor linear, thus a calibration factor must be determined to standardize the correlation between copper(II) and reducing sugar.

This analysis involves a three-part procedure to determine the blank, the calibration factor, and finally the concentration of reducing sugars. This method, HI3219EN, is used to determine the reducing sugar in wine. The result is expressed as **g/L of reducing sugar**.

### Reference:

Zoecklein, et al. Wine Analysis and Production.  
Reducing Sugars: Titrametric-Rebelein (Gold Coast) Method

### Electrode:

- HI3131B Combination ORP Electrode

### Reagents:

- HI70439 0.1M Sodium Thiosulfate (1 L)
- HI70446 Fehling A (500 mL)
- HI70447 Fehling B (500 mL)
- HI70425 16% Sulfuric Acid (500 mL)
- HI70437 Concentrated KI (500 mL)
- HI70436 Deionized Water (1 gal)

### Other Accessories:

- HI70300L Storage Solution (500 mL)
- HI7071 Electrode Fill Solution (30 mL x 4)
- HI731342 2000 $\mu$ L Automatic Pipette
- HI731352 2000 $\mu$ L Automatic Pipette Tips (4pcs)
- 150-mL Glass Beaker
- 5-mL Class-A Pipette
- 10-mL Class-A Pipette
- Hot Plate

### Device Preparation:

- Connect the ORP electrode to the titrator.
- Press "*Select Method*" from the main screen. Use the arrow keys to highlight 'HI3219EN Reducing Sugar' method and press "*Select*".
- Install a 25-mL burette with 0.1M sodium thiosulfate (HI70439) on pump-one and verify that no air bubbles are present in the burette or

tubing. If necessary prime the burette until all the air has been removed completely.

For the determination of the exact concentration of the 0.1M sodium thiosulfate, follow HI0003EN 0.1M Sodium Thiosulfate Titrant Concentration.

- Update the blank value. Press "*Method Options*" from the main screen. Use the arrow keys to highlight 'Blank Value' and press "*Select*". Use the numeric keypad to enter the blank value obtained from HI3217 Reducing Sugar – Blank and press "*Accept*".
- Update the calibration value. Press "*Method Options*" from the main screen. Use the arrow keys to highlight 'Calculations' and press "*Select*". Use the arrow keys to highlight 'Edit Variable Values' and press "*Select*". Use the arrow keys to highlight 'F1 -> General Factor' and press "*Select*". Use the numeric keypad to enter the calibration value obtained from HI3218 Reducing Sugar – Cal. and press "*Accept*". Press "*Escape*" to exit the Method Options screen and select 'Save Method' option.

### Electrode Preparation:

- Prepare the ORP electrode according to the procedure in the manual.

### Sample Preparation:

- Add 2000  $\mu$ L of wine to a 150-mL glass beaker using the automatic pipette.
- Use a class-A volumetric pipette to transfer exactly 5.00 mL of Fehling A (HI70446) and exactly 5.00 mL of Fehling B (HI70447) to the 150-mL glass beaker.
- Heat the mixture to a boil for approximately 2 minutes.
- Cool the solution to room temperature by running the beaker under tap water or submersing the bottom of the beaker in a water bath.
- Use a class-A volumetric pipette to transfer exactly 10.00 mL of concentrated potassium iodide (HI70437) to the 150-mL glass beaker.
- Use a class-A volumetric pipette to transfer exactly 10.00 mL of 16% sulfuric acid (HI70425) to the 150-mL glass beaker.
- Add approximately 70 mL of deionized water to bring the total volume to 100 mL.

## Reducing Sugar in Wine

### Analysis:

- Place the beaker under the stirrer assembly and lower it to immerse the ORP electrode and stirrer. Ensure that the reference junction of the ORP electrode is 5-6 mm below the surface. If necessary add extra deionized water.  
**NOTE:** The dispensing tip should be in contact with the surface of the sample (slightly submerged).
- Press "*Start*". The titrator will start the analysis.
- At the end of titration, when the equivalence point is reached, 'titration complete' will appear with the result. The result is expressed as **g/L residual sugar**.
- Remove the ORP electrode and stirrer from the sample and rinse them thoroughly with deionized water.
- Record the result.

**Reducing Sugar in Wine****Method Parameters:**

Name: Reducing Sugar  
 Method Revision: 3.0  
 Stirrer Configuration:  
 Stirrer: Stirrer 1  
 Stirring Speed: 1400 RPM  
 Pump Configuration:  
 Titrant Pump: Pump 1  
 Dosing Type: Dynamic  
 min Vol: 0.020 mL  
 max Vol: 0.600 mL  
 delta E: 6.500 mV  
 End Point Mode: mV 1 EQ Point, 1st Der  
 Recognition Options:  
 Threshold: 75 mV/mL  
 Range: NO  
 Filtered Derivatives: YES  
 Pre-Titration Volume: 0.000 mL  
 Pre-Titration Stir Time: 30 Sec  
 Measurement Mode: Signal Stability  
 delta E: 0.5 mV  
 delta t: 2.5 Sec  
 t-min wait: 3 Sec  
 t-max wait: 20 Sec  
 Electrode Type: ORP  
 Blank Option: Blank - V  
 Blank Value: 1.250E-2 L  
 Calculations: Generic Formula  
 Dilution Option: Disabled  
 Titrant Name: 0.1M Na2S2O3  
 Titrant Conc.: 0.1000 C  
 Analyte Size: 2.0000 mL  
 Analyte Entry: Fixed  
 Maximum Titrant Volume: 20.000 mL  
 Potential Range: -2000.0 to 2000.0 mV  
 Volume/Flow Rate: 25 mL/50 mL/min  
 Signal Averaging: 2 Readings  
 Final Result Format: XXXX

**Results:**

Titration Report  
 Method Name: Reducing Sugar  
 Time & Date: 14:55 Dec 22, 2016  
 Titration ID: Ti\_00001

Titration Results  
 Method Name: Reducing Sugar  
 Time & Date: 14:55 Dec 22, 2016  
 Analyte Size: 2.000 mL  
 End Point Volume: 1.025 mL  
 mV Equivalence Point: 218.2  
 Results: 19.81 g/L  
 Initial and Final mV: 317.9 to 166.2  
 Titration Duration: 3:33 [mm:ss]  
 Titration went to Completion  
 Operator name: \_\_\_\_\_

**Calculations:**

Calculations: Generic Formula  
 Titrant volume dosed: V (L)  
 Final result units: g/L  
 Titrant conc.: 0.100 C  
 Blank Volume: 1.250E-2 L  
 Factor 1: 0.924  
 Factor 2: 36.000  
 Factor 3: 1.0000E3  
 Sample size: 2.000E-3  

$$\text{g/L} = \frac{(1.250\text{E}-2 - V(\text{L})) * 0.1 * 0.924 * 36.0 * 1.0\text{E}3}{2.000\text{E}-3}$$



## Formol Number – pH Adjustment

### Description:

Method for the determination of assimilable nitrogen in wine. This method provides an approximate value that can be used as an index of the must nutritional value. This analysis is a two-part procedure: the first is a pH adjustment and the second is the concentration of fermentable nitrogen. The result is expressed as **mL of titrant**.

### Reference:

Wine Analysis and Production Formol Number (Nitrogen) in Wine

### Electrode:

- HI1131B Combination pH Electrode
- HI7662-T Temperature Probe

### Reagents:

- HI70456 0.1N Sodium Hydroxide (1 L)
- HI70457 1.0N Sodium Hydroxide (1 L)

### Other Accessories:

- HI70300L Storage Solution (500 mL)
- HI7071 Electrode Fill Solution (30 mL x 4)
- HI7004L pH 4.01 Buffer Solution (500 mL)
- HI7007L pH 7.01 Buffer Solution (500 mL)
- HI7010L pH 10.01 Buffer Solution (500 mL)
- 100-mL Class-A Pipette
- 250-mL Glass Beaker

### Device Preparation:

- Connect the pH electrode and temperature probe to the titrator.
- Press "*Select Method*" from the main screen. Use the arrow keys to highlight 'HI3230EN Formol Number - pH adj.' method and press "*Select*".
- Install a 25-mL burette with 0.1N sodium hydroxide (HI70456) on pump-one and verify that no air bubbles are present in the burette or tubing. If necessary prime the burette until all the air has been removed completely.

For the determination of the exact concentration of the 0.1N sodium hydroxide, follow HI0001EN 0.1N Sodium Hydroxide Titrant Concentration.

### Electrode Preparation:

- Press "*Mode*" from the main screen and press "*pH*".
- Calibrate the electrode using pH 4.01, 7.01 and 10.01 buffers. Refer to the instruction manual for calibration procedure.

### Sample Preparation:

- Use a class-A volumetric pipette to transfer exactly 100.00 mL of wine to a clean 250-mL glass beaker. Rinse the pipette into the beaker

with approximately 50 mL of deionized water. The total volume of should be roughly 150 mL.

- Add approximately 6.0 mL of 1N sodium hydroxide (HI70457).

### Analysis:

- Place the beaker under the stirrer assembly and lower it to immerse the pH electrode, temperature probe and stirrer. Ensure that the reference junction of the pH electrode is 5-6 mm below the surface.
- Press "*Start*". The titrator will start the analysis.
- At the end of titration, when pH 8.00 is reached, 'titration complete' will appear with the results. The result is expressed in **mL of titrant**.
- Remove the pH electrode, temperature probe and stirrer from the sample and rinse them thoroughly with deionized water.
- Save the pH adjusted sample and continue with 'HI3231EN Formol Number'

**Formol Number – pH Adjustment****Method Parameters:**

Name: Formol Number - pH adj.  
 Method Revision: 3.0  
 Stirrer Configuration:  
   Stirrer: Stirrer 1  
   Stirring Speed: 1200 RPM  
 Pump Configuration:  
   Titrant Pump: Pump 1  
 Dosing Type: Dynamic  
   min Vol: 0.010 mL  
   max Vol: 0.300 mL  
   delta E: 8.000 mV  
 End Point Mode: Fixed 8.000 pH  
 Pre-Titration Volume: 0.000 mL  
 Pre-Titration Stir Time: 30 Sec  
 Measurement Mode: Signal Stability  
   delta E: 0.5 mV  
   delta t: 1.0 Sec  
   t-min wait: 2 Sec  
   t-max wait: 20 Sec  
 Electrode Type: pH  
 Blank Option: No Blank  
 Calculations: No Formula (mL only)  
 Dilution Option: Disabled  
 Titrant Name: 0.1N NaOH  
 Maximum Titrant Volume: 25.000 mL  
 Potential Range: -2000.0 to 2000.0 mV  
 Volume/Flow Rate: 25 mL/50 mL/min  
 Signal Averaging: 3 Readings  
 Final Result Format: XXXX

**Results:**

Titration Report  
 Method Name: Formol Number - pH adj.  
 Time & Date: 16:17 Feb 22, 2017  
 Titration ID: Ti\_00060

Titration Results  
 Method Name: Formol Number - pH adj.  
 Time & Date: 16:17 Feb 22, 2017  
 End Point Volume: 13.265 mL  
 pH Fixed End Point: 8.000  
 Results: 13.265 mL  
 Initial and Final pH: 5.491 to 8.000  
 Titration Duration: 5:04 [mm:ss]  
 Titration went to Completion  
 Operator name: \_\_\_\_\_

**Calculations:**

Final Results unit in mL

$$\text{mL} = V * 1000$$

V = volume dispensed in liters

## Formol Number

### Description:

Method for the determination of assimilable nitrogen in wine. This method provides an approximate value that can be used as an index of the must nutritional value. This analysis is a two-part procedure: the first is a pH adjustment and the second is the concentration of fermentable nitrogen. The result is expressed as **ppm (mg/L) of fermentable nitrogen**.

### Reference:

Wine Analysis and Production Formol Number (Nitrogen) in Wine

### Electrode:

- HI1131B Combination pH Electrode
- HI7662-T Temperature Probe

### Reagents:

- HI70456 0.1N Sodium Hydroxide (1 L)
- HIFORM 37% Formaldehyde (500 mL)

### Other Accessories:

- HI70300L Storage Solution (500 mL)
- HI7071 Electrode Fill Solution (30 mL x 4)
- HI7004L pH 4.01 Buffer Solution (500 mL)
- HI7007L pH 7.01 Buffer Solution (500 mL)
- HI7010L pH 10.01 Buffer Solution (500 mL)
- 25-mL Class-A Pipette
- 100-mL Class-A Pipette
- 250-mL Glass Beaker
- 200-mL Volumetric Flask

### Device Preparation:

- Connect the pH electrode and temperature probe to the titrator.
- Press "*Select Method*" from the main screen. Use the arrow keys to highlight 'HI3230EN Formol Number' method and press "*Select*".
- Install a 25-mL burette with 0.1N sodium hydroxide (HI70456) on pump-one and verify that no air bubbles are present in the burette or tubing. If necessary prime the burette until all the air has been removed completely.  
For the determination of the exact concentration of the 0.1N sodium hydroxide, follow HI0001EN 0.1N Sodium Hydroxide Titrant Concentration.

### Electrode Preparation:

- Press "*Mode*" from the main screen and press "*pH*".
- Calibrate the electrode using pH 4.01, 7.01 and 10.01 buffers. Refer to the instruction manual for calibration procedure.

### Sample Preparation:

- Use the pH adjusted sample from HI3230 Formol Number – pH adjustment.

- Transfer the pH adjusted sample to a 200-mL class-A volumetric flask. Bring the sample up to volume with deionized water, cap and mix well.
- Use a class-A volumetric pipette to transfer exactly 100.00 mL of sample to a clean 250-mL glass beaker.
- Use a class-A volumetric pipette to transfer exactly 25.00 mL of pH adjusted 37% formaldehyde to the beaker.

**NOTE:** The formaldehyde should be adjusted or readjusted to pH 8.00, or to the specified endpoint before it is added to the sample. If no drop in pH is observed after the formaldehyde is added, the sample does not contain nitrogen in a quantifiable amount.

### Analysis:

- Place the beaker under the stirrer assembly and lower it to immerse the pH electrode, temperature probe and stirrer. Ensure that the reference junction of the pH electrode is 5-6 mm below the surface.
- Press "*Start*". The titrator will start the analysis.
- At the end of titration, when pH 8.00 is reached, 'titration complete' will appear with the results. The result is expressed in **ppm (mg/L) of fermentable nitrogen**.
- Remove the pH electrode, temperature probe and stirrer from the sample and rinse them thoroughly with deionized water.
- Record the result.

## Formol Number

### Method Parameters:

Name: Formol Number  
 Method Revision: 3.0  
 Stirrer Configuration:  
 Stirrer: Stirrer 1  
 Stirring Speed: 1200 RPM  
 Pump Configuration:  
 Titrant Pump: Pump 1  
 Dosing Type: Dynamic  
 min Vol: 0.010 mL  
 max Vol: 0.250 mL  
 delta E: 8.000 mV  
 End Point Mode: Fixed 8.000 pH  
 Pre-Titration Volume: 0.000 mL  
 Pre-Titration Stir Time: 20 Sec  
 Measurement Mode: Signal Stability  
 delta E: 0.5 mV  
 delta t: 1.0 Sec  
 t-min wait: 2 Sec  
 t-max wait: 20 Sec  
 Electrode Type: pH  
 Blank Option: No Blank  
 Calculations: Sample Calc. by Volume  
 Dilution Option: Enabled  
 Final Dilution Volume: 200.000 mL  
 Aliquot Volume: 100.000 mL  
 Titrant Name: 0.1N NaOH  
 Titrant Conc.: 0.1000 N (eq/L)  
 Analyte Size: 100.00 mL  
 Analyte Entry: Fixed  
 Maximum Titrant Volume: 25.000 mL  
 Potential Range: -2000.0 to 2000.0 mV  
 Volume/Flow Rate: 25 mL/50 mL/min  
 Signal Averaging: 3 Readings  
 Final Result Format: XXXXX

### Results:

Titration Report  
 Method Name: Formol Number  
 Time & Date: 15:49 Jan 30, 2017  
 Titration ID: Ti\_00077

### Titration Results

Method Name: Formol Number  
 Time & Date: 15:49 Jan 30, 2017  
 Analyte size: 100.00 mL  
 End Point Volume: 4.792 mL  
 pH Fixed End Point: 8.000  
 Results: 288 ppm (mg/L)  
 Initial and Final pH: 6.562 to 8.006  
 Titration Duration: 3:32 [mm:ss]  
 Titration went to Completion  
 Operator name: \_\_\_\_\_

### Calculations:

Calculations: Sample Calc. by Volume  
 Titrant units: N (eq/L)  
 Titrant volume dosed: V (L)  
 Final result units: ppm (mg/L)  
 Titrant conc.: 0.100 N (eq/L)  
 Sample/Titrant: 1.000 mol/eq  
 MW of sample: 14.016 g/mol  
 Sample volume: 100.00 mL  

$$\text{ppm} = \frac{V(L) * 0.100 * 1.000 * 14.016 * 1000}{100.00}$$



---

# General Titration Applications Brochure

## HI901 Wine

# AUTOMATIC POTENTIOMETRIC TITRATOR

Revision 1.00

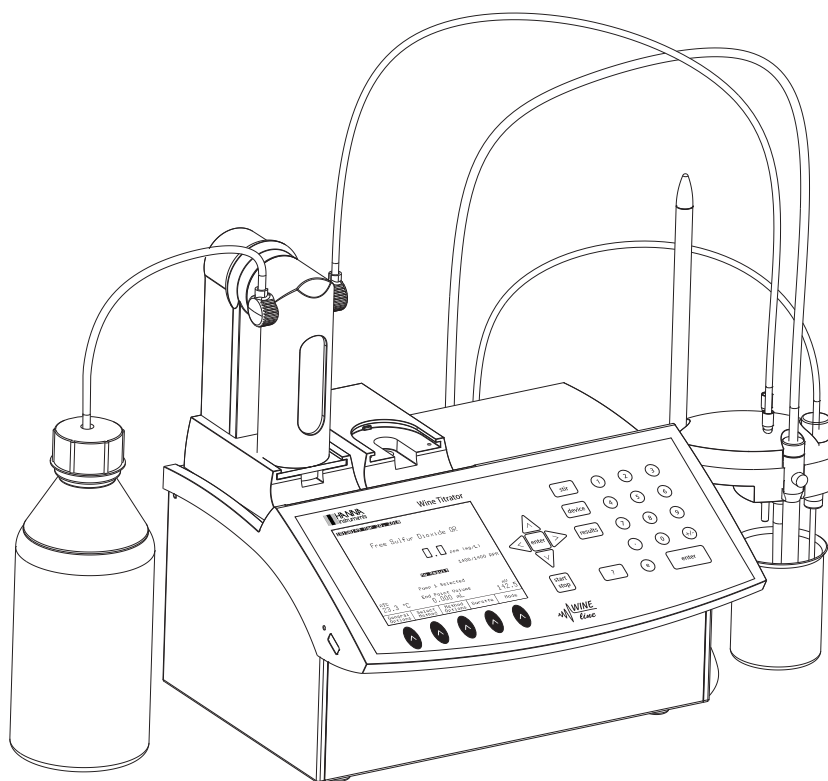

 **HANNA**<sup>®</sup>  
instruments

[www.hannainst.com](http://www.hannainst.com)

---

---

# TITRATION THEORY

HI 901 and HI 902

## AUTOMATIC POTENTIOMETRIC TITRATOR

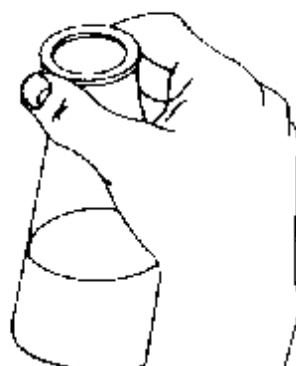
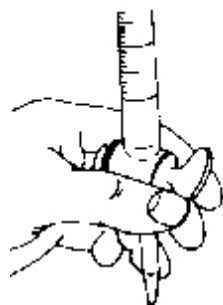



**Contents**

<b>1</b>	<b>GENERAL REVIEW OF TITRATION THEORY .....</b>	<b>5</b>
1.1	Introduction to Titrations .....	5
1.2	Uses of Titrations .....	5
1.3	Advantages and Disadvantages of Titrations .....	6
<b>2</b>	<b>TYPES OF TITRATION .....</b>	<b>7</b>
2.1	Titrations According to The Measurement Method .....	7
2.1.1	Amperometric Titrations .....	7
2.1.2	Potentiometric Titrations .....	7
2.1.3	Spectrophotometric Titrations .....	8
2.2	Titrations According to The Reaction Type .....	9
2.2.1	Acid - Base Titrations .....	9
2.2.2	Argentometric Titrations .....	10
2.2.3	Complexometric Titrations .....	10
2.2.4	Ion Selective Titrations .....	11
2.2.5	Non-aqueous Solvent Acid - Base Titrations .....	11
2.2.6	Precipitation Titrations .....	12
2.2.7	Redox Titrations .....	12
2.2.8	Karl Fischer Titration .....	13
2.3	Titrations According to The Titration Sequence .....	13
2.3.1	Back Titrations .....	13
2.3.2	Multiple Endpoint Titrations .....	14
<b>3</b>	<b>INTRODUCTION TO TITRATION APPARATUS AND TYPICAL TITRATION PROCEDURE .....</b>	<b>15</b>
3.1	Manual Titration .....	15
3.2	Automatic Titration .....	16
<b>4</b>	<b>TITRATION RESULTS .....</b>	<b>17</b>
4.1	Accuracy .....	17
4.2	Repeatability .....	17

# TITRATION THEORY

---

<b>4.3</b>	<b>Sources of Error</b> .....	<b>17</b>
4.3.1	Sampling Errors .....	17
4.3.2	Errors with Titrant and Standard .....	17
4.3.2.1	Preparation Errors .....	17
4.3.2.2	Dispensing Errors .....	18
4.3.3	Chemical Reaction Errors .....	18
4.3.4	Endpoint Determination Errors .....	18
<b>5</b>	<b>CALCULATIONS</b> .....	<b>19</b>
5.1	Sample Calculation .....	19
5.2	Standardize Titrant .....	19
5.3	Blank Titration .....	20
5.4	Multiple Endpoint Titration .....	20
5.5	Back Titration .....	21
<b>6</b>	<b>GLOSSARY</b> .....	<b>22</b>

## 1 GENERAL REVIEW OF TITRATION THEORY

### 1.1 Introduction to Titrations

A titration is a quantitative, volumetric procedure used in analytical chemistry to determine the concentration of an analyte (the species being measured) in solution. The concentration of the analyte is determined by slowly adding a titrant (reagent) to the solution. As the titrant is added, a chemical reaction occurs between the titrant and the analyte.

Titration reactions are relatively fast, simple reactions that can be expressed using a chemical equation. The titration reaction continues as the titrant is added until all of the analyte is consumed and the analyte reacts completely and quantitatively with the titrant.

The point at which all of the analyte has been reacted is called the equivalence point, also known as the theoretical or stoichiometric endpoint. This point is accompanied by an abrupt physical change in the solution, which sharply defines the endpoint of the reaction. The physical change associated with the titration endpoint can be produced by the titrant or an indicator and can be detected either visually or by some other physical measurement.

Titration cannot be used to determine the quantity of all analytes. The chemical reaction between the titrant and analyte must fulfill four requirements:

- The reaction must be fast and occur within approximately one second after the titrant is added
- The reaction must go to completion
- The reaction must have well-known stoichiometry (reaction ratios)
- A convenient endpoint or inflection point

Titration is highly precise and can provide many advantages over alternative methods. Titrations are quickly performed and require relatively simple apparatus and instrumentation.

### 1.2 Uses of Titrations

Titration can be used in many applications, including:

- Acid content of plant effluents, food (e.g.: cheese and wine), plating and etching baths, petroleum products, drugs
- Base content of fertilizer (containing ammonia), bleach, minerals
- Hardness in water
- Metal content of alloys, minerals, ores, clays, waters, plating baths, paints, paper, plant materials, biological fluids, petroleum products
- Moisture content in foodstuffs, petrochemicals, pharmaceutical products, and plastics
- Redox reagent concentrations such as available chlorine in potable water, peroxide, traces of oxidants and reductants in food, reductants in high temperature or high pressure boiler water, vitamin analysis

## 1.3 Advantages and Disadvantages of Titrations

Some advantages of titrations as an analytical technique are:

- More precise results than many instrumental methods, such as measurement by electrode, the accuracy of the measurement is up to 0.1%
- Simple methods, reasonable capital costs, and easy training
- Suitability to measure major components of a mixture or product
- Automation can reduce time and labor spent on each analysis

Some disadvantages of titrations are:

- Time it takes to prepare standards and titrants
- Good technique is required to achieve precise results (training and practice required)
- Not suitable for determining trace or minor components of a mixture or product
- Limited dynamic range, it may require additional sample preparations (dilution) and repeat analyses

## 2 TYPES OF TITRATIONS

### 2.1 Titrations According to The Measurement Method

#### 2.1.1 Amperometric Titrations

An amperometric titration is performed by placing two electrodes (often a metal ISE and a reference electrode) into the sample solution and holding the potential of the metal electrode at a selected voltage. The current that flows, due to the oxidation or reduction of a reactant or product, is plotted vs. volume of titrant to provide the titration curve and locate the equivalence point. Changes in the current are due to changes in the concentration of a particular species (being oxidized or reduced at the electrode).

Generally the reaction between the analyte and titrant forms a new species. Depending on the titration, the reactants are electroactive and the products are not, or vice-versa. Amperometric titration curves look like two straight lines intersecting at the equivalence point, this is due to the change in the electroactivity of the solution.

Many metal ions can be amperometrically titrated using a precipitation, complexation or redox reaction. Some metal ions and species that can be determined in this manner include silver, barium, halides, potassium, magnesium, palladium, molybdate, sulfate, tungstate, zinc, bismuth, cadmium, fluoride, indium, thallium, iodine, and gold.

Figure 1 shows four amperometric titrations and their endpoints. In graph "A" the analyte is electroactive and gives current but the reacted species does not. In "B" the reactant is not active but the titrant is. In "C" both the analyte and titrant are active and both give current flow. Graph "D" shows the same situation as "B"; however, the current has an opposite sign (the titrant is reduced).

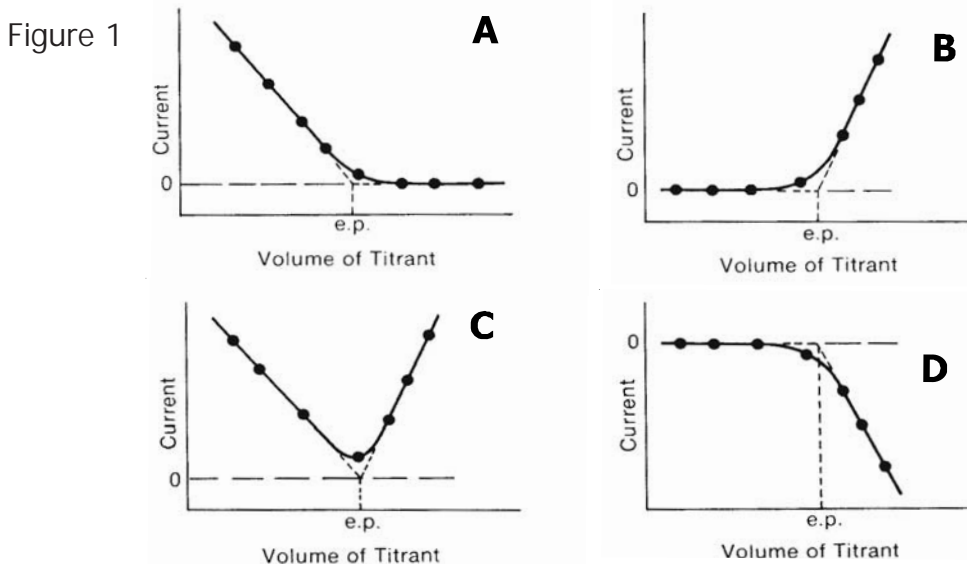

#### 2.1.2 Potentiometric Titrations

Potentiometric titrations are done by measuring the voltage across the solution using an electrode system. An electrode system consists of an indicator electrode and a reference electrode. As titrant is added the variations in the potential of the indicator electrode, with respect to the reference electrode, are monitored to show the progress of the titration.

Potentiometry is the measurement of a potential under conditions of zero current flow. The



# TITRATION THEORY

measured potential can then be used to determine the analytical quantity of interest, generally a component concentration of the analyte solution. The potential that develops in the electrochemical cell is the result of the free energy change that would occur if the chemical phenomena were to proceed until the equilibrium condition has been satisfied.

There are many types of titrations where potentiometry can be used, e.g., pH electrodes for acid-base titrations, platinum ORP electrodes in redox titrations, ion selective electrodes, such as chloride or fluoride for a specific ion titration, and silver electrodes for argentometric (silver-based) titrations. An example of potentiometric titrations are shown below. Figure 2 "A" is the pH of a solution vs. the volume of titrant and "B" is the potential from a chloride electrode vs. the volume of  $\text{AgNO}_3$ .

Figure 2

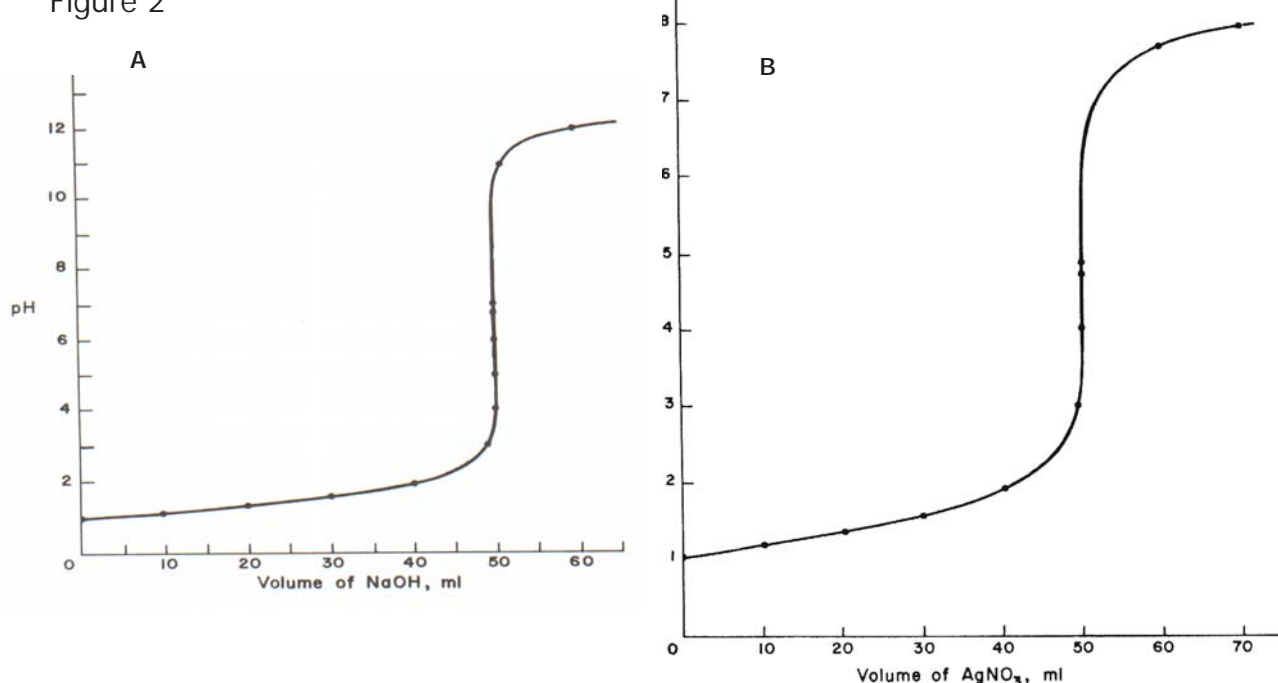

## 2.1.3 Spectrophotometric Titrations

The name comes from the method used to detect the endpoint of the titration, not its chemistry. Highly colored indicators that change color during the course of the titration are available for many titrations. More accurate data on the titration curve can be obtained if the light absorption is monitored instrumentally using a light source, a simple monochromator and a photodetector, rather than visually determining the color or light absorption change. Light absorption by either an indicator or by one of the reactants or products can be used to monitor the titration.

In the first titration curve, Figure 3 "A", the absorption of a metal-indicator complex is being monitored. The absorption is constant while the metal is complexed by the EDTA titrant. The metal indicator complex was stripped, causing a sharp break in the titration curve. The point where all the metal is complexed and stripped from the indicator is the equivalence point. This point is marked by "e.p." on the graph.

In the second titration curve, Figure 3 "B", the metal complex is being measured while being titrated with EDTA. The new complex being formed is not colored and does not absorb light. The extrapolated intersection of the two lines determines the equivalence point.

Figure 3

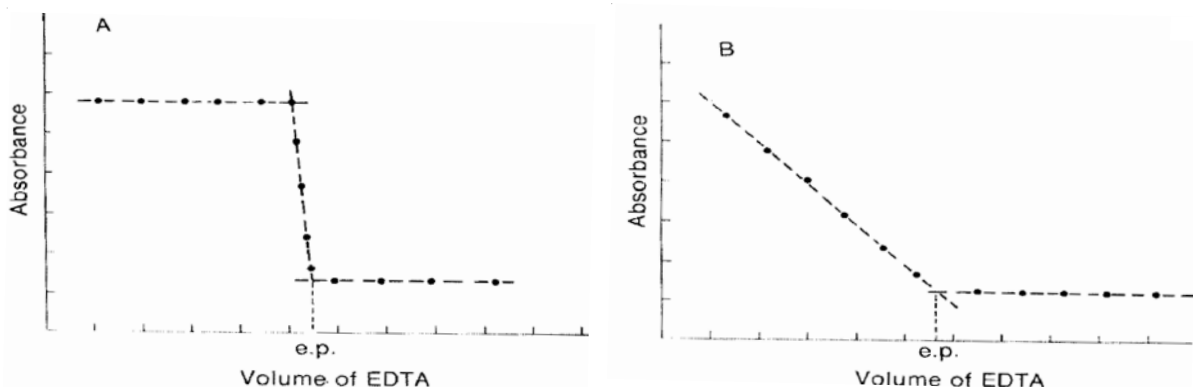

## 2.2 Titrations According to The Reaction Type

### 2.2.1 Acid-Base Titrations

Acid–base titrations are the most common type of titrations. They are based upon a reaction between an acid and a base, a stoichiometric neutralization, or the exchange of protons. Virtually all acid-base titrations are carried out using a strong acid or a strong base as the titrant. The endpoint of a titration carried out with a weak acid or a weak base would be difficult to detect due to a small change in pH at the equivalence point.

Chemical indicators can be used to determine the endpoint. The indicator will change color to signify that the end of the titration has been reached. The color of the indicator is dependent upon the concentration of ions in the solution. An acid-base indicator is composed of a conjugate weak acid-weak base pair, where the two forms exhibit different colors depending on the pH of the solution. For an indicator, the acid ionization constant  $K_a$  is usually written as:

$$K_a = \frac{[H_3O^+][In^-]}{[HIn]}$$

HIn is the acid form of the indicator and  $In^-$  is the base form. At the center of the change region, the ratio of  $[In^-]$  to  $[HIn]$  is one,  $[H_3O^+] = K_a$  and  $pH = pK_a$ . The color change region is usually  $\pm 1$  pH unit around this point. Table 1 contains a list of some aqueous acid-base chemical indicators, as well as the pH range, the  $pK_a$  and the expected color (acid and base form). When choosing the proper indicator you should select one that has a  $pK_a$  as close to the endpoint of the titration.

When chemical indicators are not suitable, a potentiometric pH titration can also be used. The pH of the solution is plotted versus the volume of titrant added. Figure 4 shows a traditional strong acid-strong base titration curve. The graph shows the

Table 1

pH Range	Indicator	$pK_a$	Acid Form	Base Form
0.0 - 1.6	Methyl Violet		Yellow	Blue
1.2 - 2.8	Thymol Blue	1.65	Red	Yellow
3.2 - 4.4	Methyl Orange	3.46	Red	Yellow
3.8 - 5.4	Bromocresol Green	4.90	Yellow	Blue
4.8 - 6.0	Methyl Red	5.00	Red	Yellow
5.2 - 6.8	Chlorophenol Blue	6.25	Yellow	Red
6.0 - 7.6	Bromothymol Blue	7.30	Yellow	Blue
6.6 - 8.0	Phenol Red	8.00	Yellow	Red
7.4 - 9.0	Metacresol Purple	8.30	Yellow	Purple
8.0 - 9.6	Thymol Blue	9.20	Yellow	Blue
8.2 - 10.0	Phenolphthalein	9.50	Clear	Pink
9.4 - 10.6	Thymolphthalein		Clear	Blue
10.1 - 12.0	Alizarin Yellow R		Yellow	Red
11.4 - 12.6	Indigo Carmine		Blue	Yellow

# TITRATION THEORY

volume of NaOH added to an acidic solution and the resulting pH of the solution. Note the abrupt change in the pH at the equivalence point.

## 2.2.2 Argentometric Titrations

Argentometric titrations use silver (nitrate) as the titrant and are generally precipitation titrations, as many silver salts are insoluble. These titrations are commonly used to titrate and determine the concentration of bromide, chloride, cyanide, iodide, and sulfide.

Argentometric titrations can be done with Mohr's indicator (when all of the chloride has reacted, a red silver chromate precipitate is formed) or the titration can be easily followed with a silver ISE (or chloride ISE for chloride titrations) and a reference electrode.

Figure 5 shows the titration of 50 mL of 0.1N NaCl with 0.1N  $\text{AgNO}_3$ . The potentiometric signal is from a chloride ISE and is plotted as pCl ( $-\log [\text{Cl}^-]$ ).

Figure 4

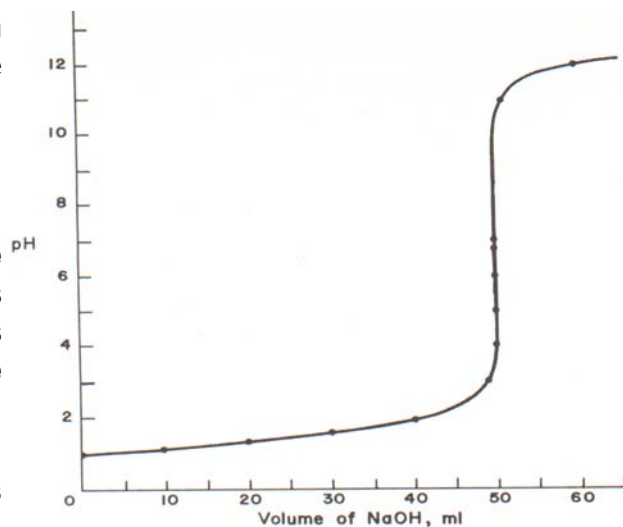
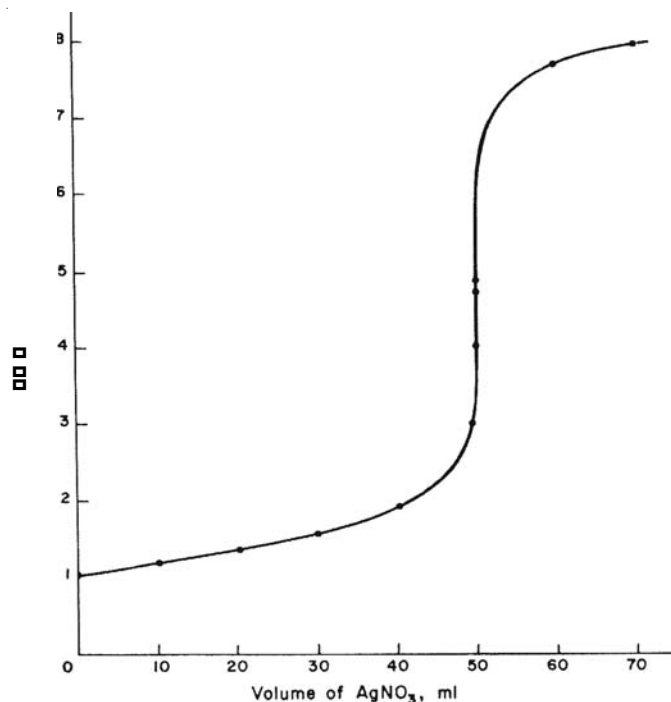

Figure 5



## 2.2.3 Complexometric Titrations

A complex is a species where a central metal ion is covalently bonded to one or more electron donating groups called ligands. In a complexometric titration, metal ions are titrated using a titrant that binds strongly to it. Often these titrants contain EDTA or CDTA, polydentate ligands that form very stable coordination compounds with metal ions. The complexation reaction must be fast in order to be useful for direct titration. Some metal ions react too slowly with EDTA for a direct titration.

An indicator electrode that responds to the metal ion can be used to monitor the titration progress. The titration curve will appear similar to a usual potentiometric titration. Complexation indicators change color at the endpoint as all metal ions are "consumed", or complexed, by the titrant.

The titration curve will appear similar to a potentiometric titration when using an indicator electrode that responds to the metal ion (see Figure 6).

Figure 6

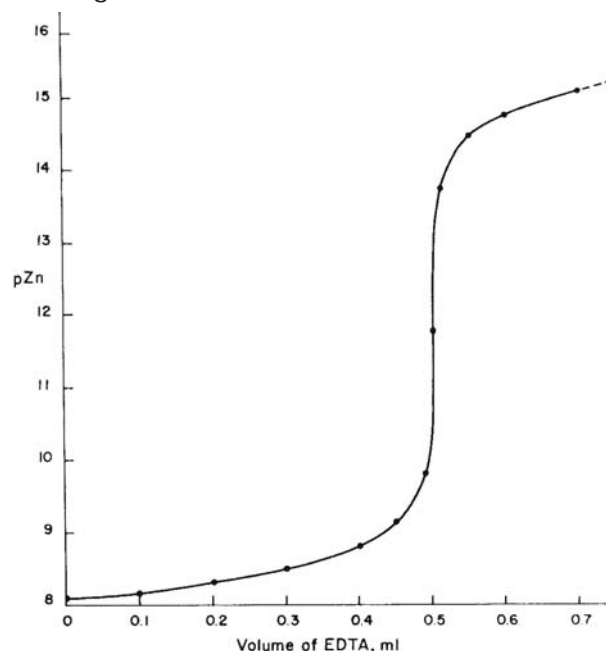

## 2.2.4 Ion Selective Titrations

The most popular ion selective titration is an acid-base titration. The hydrogen ion concentration is specifically measured and monitored during the titration process to locate the equivalence point. Using an ion selective electrode (ISE) as the indicator electrode, the potentiometric signal (in mV) is used to directly follow a specific ion's concentration (or activity).

Examples of ISE titrations include titrating fluoride with an aluminum titrant using a fluoride ISE, chloride with silver nitrate using a chloride ISE, sodium with a sodium ISE, etc. The equivalence point can be determined by plotting the mV value vs. the amount of titrant added.

## 2.2.5 Non-aqueous Solvent Acid-Base Titrations

Non-aqueous solvents must be used to titrate very weak acids and bases due to the inherent leveling effect water has on all acids and bases dissolved in it. A wide variety of weak acids and bases can be titrated using non-aqueous solvents. Mixtures of acids or bases can often be individually analyzed in a single sequential titration.

### Titration of Acids

Weak acids with  $pK_a$ 's up to about 11 can be titrated in non-aqueous solvents. These include carboxylic acids, enols, phenols, imides, sulfonic acids, and inorganic acids. Water or lower alcohols are suitable for titrating medium to strong acids ( $pK_a$  less than 5). Titrating a weaker acid with a strong base titrant requires a solvent less acidic than water or ethanol/methanol. Solvents such as acetone, acetonitrile, t-butyl

Figure 7

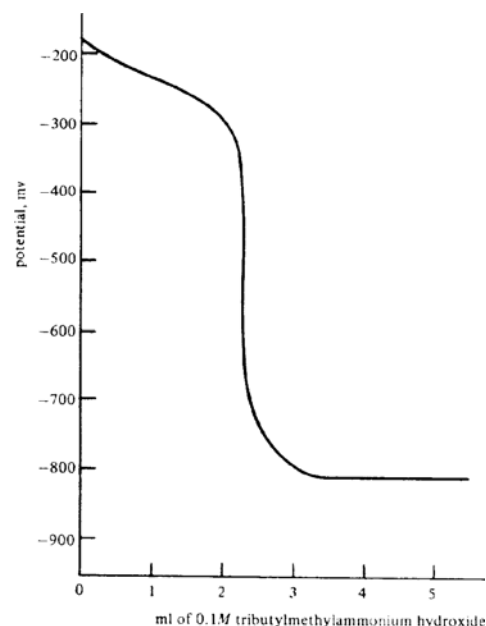

alcohol, dimethylformamide, isopropanol and pyridine have been found to work well for acid-base titrations of strong, medium and weak acids/bases. Titrants include alcoholic potassium hydroxide and various sodium or potassium alkoxides in a 10:1 mixture of benzene/methanol. The best titrants are quaternary ammonium hydroxides (such as tetrabutylammonium hydroxide) due to good solubility of tetraalkylammonium salts of the titrated acids and the clean potentiometric titration curve obtained (see Figure 7).

## Titration of Bases

Weak bases with  $pK_b$ 's up to about 11, which do not ionize with water, can be titrated in non-aqueous solvents. These bases include aliphatic and aromatic amines, basic nitrogen heterocycles, alkali metal and amine salts of acids, and many other organic basic compounds. Titrating a weak base with a strong acid titrant requires a basic solvent that is as weak as possible. Water and alcohols allow the titration of medium strength bases such as aliphatic amines ( $pK_b = 4$  to  $5$ ), but not the titration of weaker bases such as pyridine ( $pK_b = 8.8$ ). Glacial acetic acid works well for weak bases and has been used extensively. Less basic solvents such as acetone, acetonitrile, and nitromethane extend the range of titrable compounds.

The endpoint for non-aqueous titrations are usually determined potentiometrically using a pH glass electrode, a modified calomel or double junction reference electrode with a low-flow rate reference junction. Good potentiometric titration curves are obtained in most solvents, except those with very low dielectric constants such as benzene, chloroform and others, when high electrical resistance of the solvent causes unstable potentials.

## 2.2.6 Precipitation Titrations

Precipitation titrations allow for faster analysis compared to the old gravimetric analysis, where a precipitate is formed, filtered, dried and weighed to analyze a compound. Typically silver halides, silver thiocyanate and a few mercury, lead, and zinc salts are titrated using this method. The chemical reactions must form an insoluble salt and precipitate out quickly in order to be analyzed by this method. When the reaction is not quick, a back titration can be used. A measured excess of the precipitating reagent (titrant) is added to force the reaction to occur, and then unreacted titrant is then titrated with a standard solution of another reagent.

## 2.2.7 Redox Titrations

There are a number of oxidation-reduction reactions that can be used to determine unknown concentration by titration. If the reaction goes to completion, is fast and has an analytical signal available to follow it, a titration can be performed. The term "fast" means that each addition of titrant is reacted completely and the sensing electrode is able to detect the change in solution in less than one second.

Redox titrations are potentiometric titrations where the mV signal from a combination ORP (redox) electrode (usually with a platinum indicator electrode) is used to follow the reaction of oxidant/reductant. The electrode potential is determined by the Nernst equation and is controlled by the oxidant/reductant ratio.

Visual indicators such as Ferrion are also available. The oxidized and reduced form of the indicator will have different colors and can be used to determine the end point.

Various reductants can be determined by titrants with oxidants such as potassium permanganate, potassium chromate or iodine. Commonly used reductants that are used as titrants include sodium thiosulfate, and ferrous ammonium sulfate.

Figure 8

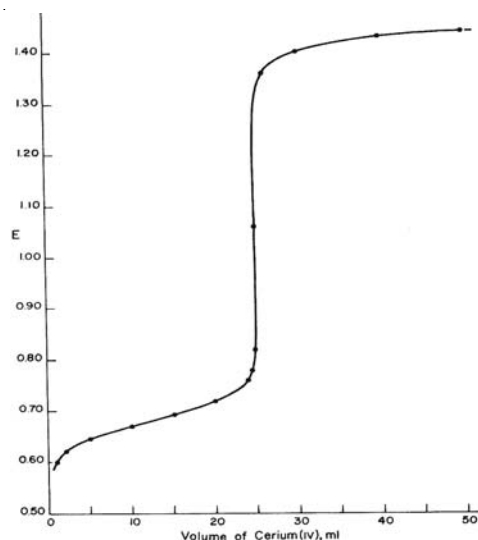

As with Acid-Base titrations the potential changes dramatically at the equivalence point.

### 2.2.8 Karl Fischer Titrations

This method is based on a well-defined chemical reaction between water and the Karl Fischer reagent. The chemistry provides excellent specificity for water determination. The method can be used to determine free and bound water in a sample matrix. The Karl Fischer method is widely considered to produce the most rapid, accurate and reproducible results and has the largest detectable concentration range spanning 1 ppm to 100%.

The determination of water content is one of the most commonly practiced methods in laboratories around the world. Knowledge of water content is critical to understanding chemical and physical properties of materials and ascertaining product quality. Water content determination is conducted on many sample types including pharmaceuticals and cosmetics, foods and natural products, organic and inorganic compounds, chemicals, solvents and gases, petroleum and plastic products as well as paints and adhesives. The KF method is verifiable and can be fully documented. As a result, Karl Fischer titration is the standard method for analysis of water in a multitude of samples as specified by numerous organizations including the Association of Official Analytical Chemists, the United States and European Pharmacopoeia, ASTM, American Petroleum Institute, British Standards and DIN.

## 2.3 Titrations According to The Titration Sequence

### 2.3.1 Back Titrations

Back titrations are generally used when a reaction is too slow to be directly accomplished using a "direct" titration, where the reaction goes to completion within a few seconds. In a back titration, a large excess of a reagent is added to the sample solution, helping a slow reaction to go to completion. The unreacted, excess reagent is then titrated. The difference in the total volume of the first reagent added and amount determined from the second titration is the quantity of reagent required to complete the first reaction.

## 2.3.2 Multiple Endpoint Titrations

Under certain conditions, some titrations can exhibit more than one equivalence point and be titratable to the individual endpoints to determine the concentration of each individual component. Examples of these types of titrations include acid-base (where different strength acid or bases are in a mixture), redox (where each species has a different reduction potential), complexometric (where different species are separately titratable), and acid-base using polyprotic acids (the  $pK_a$  of the different protons varies enough to separate them).

Figure 9 shows three different types of multiple endpoint titrations. "A" shows the titration of a polyprotic acid. The different acid strengths of the first and second proton can be determined. "B" illustrates a mixture of two different metal redox species, where the different redox potentials allow the species to be separated. "C" is the titration of a solution containing strong, weak, and very weak acids.

Figure 9

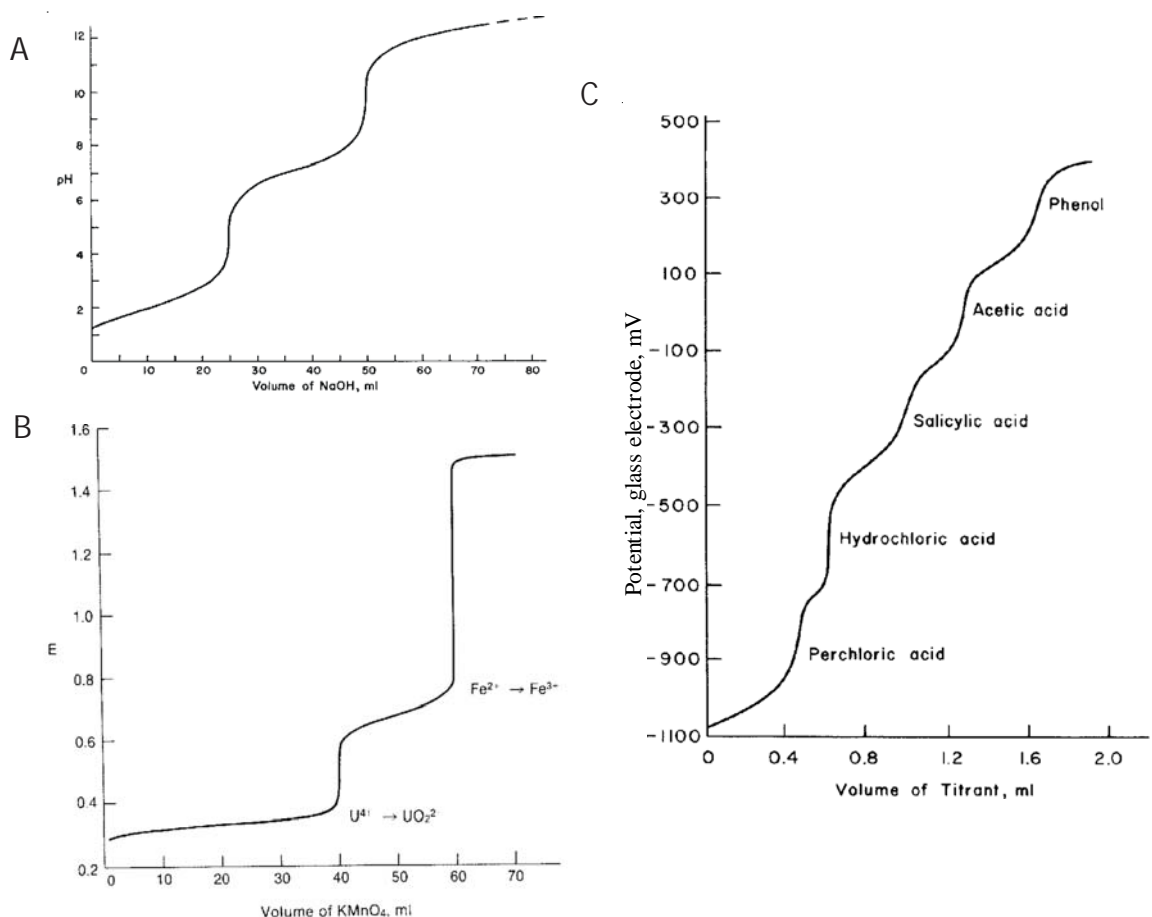

### 3 INTRODUCTION TO TITRATION APPARATUS AND TYPICAL TITRATION PROCEDURE

#### 3.1 Manual Titration

Apparatus required for manual titration include:

- Volumetric Burette, for precisely controlled delivery of titrant to the reaction vessel
- An Erlenmeyer, or similar flask, that facilitates constant mixing or swirling required to ensure solution homogeneity
- Volumetric pipettes for the precise addition of samples and indicator solutions
- Titrant solutions of known concentration
- A visual or instrumental indicator for detecting the completion of the reaction

A typical manual titration consists of the following steps:

1. A volumetric pipette is typically used to add a known volume of sample to the flask
2. An indicator solution or instrument probe is added to the flask
3. A burette is used to measure the addition of titrant to the flask and dispense titrant in a controlled manner
4. Titrant is added via the burette until the method indication signals the reaction endpoint
5. The concentration of analyte is calculated based on the concentration and volume of titrant required to reach the endpoint

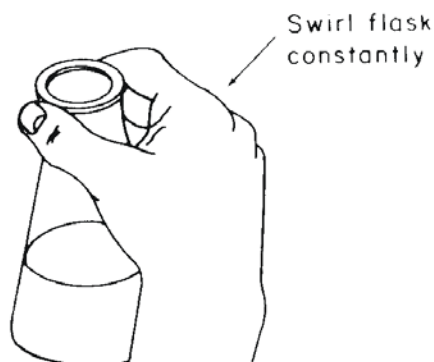
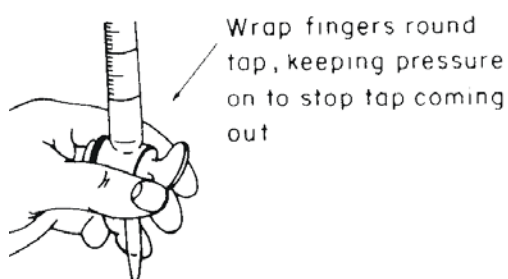



## 3.2 Automatic Titration

Automatic titrators are high-precision analytical instruments that deliver the titrant, monitor the physical change associated with the titration reaction, automatically stop at the endpoint and calculates the concentration of the analyte. Automatic titrators are best for repetitive titrations and high-accuracy analyses.

An automatic titrator must have an accurate liquid dispensing system. In high accuracy systems like the HI 900-series titrators, the liquid dispensing system consists of a stepper-motor driven piston syringe burette capable of accurately and precisely dispensing very small volumes of titrant, a valve system to switch between titrant intake and outlet and a dispensing tip. These three main subsystem components must be as accurate as possible, with very low gear backlash in the burette pump, minimal piston seal flexing, precision ground inner diameter of the glass syringe, a low dead volume valve, minimal evaporation/permeation, and chemically resistant tubing.

Apparatus required for automatic titration include:

- An automatic titrator, equipped with a burette
- A beaker
- An electronic stirring system, either a propeller stirrer or a magnetic stir bar and stir plate
- Volumetric pipettes for the precise addition of samples
- Standard titrant solutions of known concentration
- An electrode system that can be used to determine the endpoint of the titration

A typical automatic titration consists of the following steps:

1. Set up the automatic titrator according to the manufacturer's instructions
2. A volumetric pipette is typically used to add a known volume of sample to the beaker
3. Submerge the propeller stirrer or add the stir bar to the beaker, and turn on
4. Start the titration, the titrator will automatically stop at the endpoint and determine the concentration of the analyte

## 4 TITRATION RESULTS

### 4.1 Accuracy

The factors most critical to achieving accurate results with the HI 900 titration systems are the concentration of the sample, size of the sample and having an optimized set of method parameters.

### 4.2 Repeatability

Repeatability, or the agreement between replicate determinations, is expressed quantitatively as the relative standard deviation (RSD).

### 4.3 Sources of Error

One of the advantages of volumetric analysis is excellent accuracy and precision. The sources of error can be grouped into sampling, titrant and standards, chemical reactions, endpoint determination and calculations.

#### 4.3.1 Sampling Errors

- Selection of a non-homogeneous or non-representative sample
- Sample changed or was contaminated during collection, storage or transfers
- Poor technique when transferring sample to beaker or flask
- Errors in the balance, calibrate and check balance regularly

#### 4.3.2 Errors with Titrant and Standard

##### 4.3.2.1 Preparation Errors

Incorrect preparation due to:

- Poor technique in weighing the salt or when transferring to volumetric glassware
- Low-purity of salts or water used to make titrant and standard
- Dirty or wet glassware
- Improper storage of titrant or standard which allows water gain, evaporation or deterioration
- Failure to standardize frequently to adjust for change in titrant
- Failure to flush titrator tubing with a volume of titrant before standardizing
- Volume errors from pipettes and volumetric flasks, grade A glassware is required
- Balance errors when weighing out salts, calibrate and check balance regularly

## 4.3.2.2 Dispensing Errors

Incorrect dispensing due to:

- Dead valve volume and leaking valve
- Inaccuracy in motor drive and gear lash/ backlash
- Poor burette/ piston seal
- Non-uniform diameter of burette glass cylinder
- Chemical incompatibility with tubing or bubble generation
- Density/ temperature changes in titrant

## 4.3.3 Chemical Reaction Errors

- Inappropriate solvent or sample resulting in side reactions
- Poor mixing of the titrant and solvent or sample in the titration vessel
- Reaction between titrant and sample is not rapid
- Reaction does not go to completion
- Reaction has side reactions

## 4.3.4 Endpoint Determination Errors

Most manual titrations use a visual indicator to indicate when the endpoint is reached and the titration should be stopped. Automatic titrators use instrumental methods to determine the end of a titration and the equivalence point. There are two predominant methods used to determine the equivalence point, first derivative and second derivative.

The inflection point of the titration curve (mV vs. Volume) is normally assumed to be the equivalence point. The first derivative is often used to determine the inflection point. The maximum value of the first derivative (dmV vs. dV) corresponds to the theoretical equivalence point. During a titration it is rare to have a data point exactly at the first derivative maximum, the maximum value is determined by interpolating the first derivative data points.

The second derivative ( $d^2 \text{ mV vs. } dV^2$ ) can also be used to determine the equivalence point, and can offer advantages over the first derivative method. Second derivatives have increased sensitivity to smaller inflection points and easier numerical evaluation of the actual equivalence point. The value where the second derivative is equal to zero is the equivalence point. The second derivative requires fewer points located near the equivalence point, where data is often not obtained or not as reliable.

Errors in determining the endpoint can result from:

- Incorrect signals from the sensor
- Sensor drift
- Sensor or instrument has slow response, keep sensors in good condition
- Inappropriate setting on the titrator

## 5 CALCULATIONS

The main variables used in calculating a result from a titration are the sample volume, the concentration of the titrant, and the volume of titrant required to reach the equivalence point. At the equivalence point, an equal number of equivalents of the analyte and titrant has been added.

### 5.1 Sample Calculation

#### By Mass

$$C_{sample} = \frac{V_{titrant} \times C_{titrant} \times Ratio \times FW_{analyte}}{m_{sample}} \times 100$$

C sample	Sample Concentration (g/100g)
V titrant	Volume of titrant (L)
C titrant	Titrant Concentration (eq/L)
Ratio	Equivalence ratio of analyte/ titrant (mol analyte/ eq titrant)
FW analyte	Formula Weight of the Analyte (g/mol)
m sample	Mass of sample (g)

#### By Volume

$$C_{sample} = \frac{V_{titrant} \times C_{titrant} \times Ratio \times FW_{analyte}}{V_{sample}} \times 100$$

C sample	Sample Concentration (g/100mL)
V titrant	Volume of titrant (L)
C titrant	Titrant Concentration (eq/L)
Ratio	Equivalence ratio of analyte/ titrant (mol analyte/ eq titrant)
FW analyte	Formula Weight of the Analyte (g/mol)
V sample	Volume of Sample (mL)

### 5.2 Standardize Titrant

Titrant standardization is the second most important calculation in titrations. A primary standard is titrated in order to determine the concentration of the titrant. This is essentially a typical titration calculated in "reverse", where the concentration of the solution is known and the titrant is the unknown.

#### By Mass

$$C_{titrant} = \frac{m_{standard} \times Ratio}{FW_{standard} \times V_{titrant}}$$

C titrant	Titrant Concentration (N)
m standard	Mass of Standard (g)
Ratio	Equivalence ratio of titrant/standard (eq titrant/ mol standard)
FW standard	Formula Weight of the Standard (g/mol)
V titrant	Volume of Titrant (L)

# TITRATION THEORY

---

## By Volume

$$C_{\text{titrant}} = \frac{V_{\text{standard}} \times (1 \text{ L} / 1000 \text{ mL}) \times C_{\text{standard}}}{V_{\text{titrant}}}$$

C titrant	Concentration of titrant (N)
V standard	Volume of Standard (mL)
C standard	Concentration of standard (eq/L)
V titrant	Volume of Titrant (L)

## 5.3 Blank Titration

In a blank titration a pre-titration is performed, often times on the solvent to be used for the sample titration, and the titrant volume required to reach the endpoint is noted. This blank value nullifies error due to titrant required to react with the components of the titration solution matrix. The basic titration equation can be used for a blank titration, with the single modification that the volume of titrant used in the blank titration should be subtracted from the regular titration titrant volume.

$$C_{\text{sample}} = \frac{C_{\text{titrant}} \times (V_{\text{sample}} - V_{\text{blank}}) \times \text{Ratio} \times \text{FW}_{\text{analyte}}}{m_{\text{sample}}} \times 100$$

C Sample	Sample Concentration (g/100g)
C titrant	Titrant Concentration (eq/L)
V sample	Volume of Titrant required for the sample (L)
V blank	Volume of Titrant required for the blank (L)
Ratio	Equivalence ratio of analyte/ titrant (mol analyte/ eq titrant)
FW analyte	Formula Weight of the Analyte (g/mol)
m sample	Mass of sample (g)

## 5.4 Multiple Endpoint Titration

Some titrations have two or more endpoints, each corresponding to the equivalence point for a specific reaction. Multiple endpoint titrations are similar to a blank titration in that the volume of titrant required to reach the first endpoint is subtracted from the titrant volume used to reach the next sequential endpoint.

$$C_{\text{sample 1}} = \frac{V_{\text{titrant 1}} \times C_{\text{titrant}} \times \text{Ratio} \times \text{FW}_{\text{analyte 1}}}{m_{\text{sample}}} \times 100$$

$$C_{\text{sample 2}} = \frac{(V_{\text{titrant 2}} - V_{\text{titrant 1}}) \times C_{\text{titrant}} \times \text{Ratio} \times \text{FW}_{\text{analyte 2}}}{m_{\text{sample}}} \times 100$$

$$C_{\text{sample 3}} = \frac{(V_{\text{titrant 3}} - V_{\text{titrant 2}}) \times C_{\text{titrant}} \times \text{Ratio} \times \text{FW}_{\text{analyte 3}}}{m_{\text{sample}}} \times 100$$

C sample1	Sample 1 Concentration (g/100g)
C sample2	Sample 2 Concentration (g/100g)
C sample3	Sample 3 Concentration (g/100g)
V titrant 1	Volume of titrant required to reach the first end point (L)
V titrant 2	Volume of titrant required to reach the second end point (L)
V titrant 3	Volume of titrant required to reach the third end point (L)
C titrant	Concentration of titrant (N)
Ratio	Equivalence ratio of analyte/ titrant (mol analyte/ eq titrant)
FW analyte 1	Formula Weight of the Analyte 1 (g/mol)
FW analyte 2	Formula Weight of the Analyte 2 (g/mol)
FW analyte 3	Formula Weight of the Analyte 3 (g/mol)
m sample	Weight of Sample (mL)

## 5.5 Back Titration

The equation used in back titration calculations is also similar to the equation for a blank titration. Instead of subtracting the initial amount of titrant needed to react with the blank, the amount of second titrant needed to react with the excess titrant added in the first titration is subtracted from the amount of the first titrant added. The difference between the two amounts is the amount of titrant necessary to reach the first equivalence point.

$$C_{sample} = \frac{(C_{titrant\ 1} \times V_{titrant\ 1} - C_{titrant\ 2} \times V_{titrant\ 2}) \times Ratio \times FW_{analyte}}{V_{sample}} \times 100$$

C sample	Sample Concentration (g/100mL)
C titrant 1	Concentration of titrant 1 (N)
V titrant 1	Volume of titrant 1 (L)
C titrant 2	Concentration of titrant 2 (N)
V titrant 2	Volume of titrant 2 (L)
Ratio	Equivalence ratio of analyte/ titrant (mol analyte/ eq titrant)
FW analyte	Formula Weight of the analyte (g/mol)
V sample	Volume of sample (mL)

## 6 GLOSSARY

### Acid

A chemical species that can donate one or more protons (hydrogen ions).

### Acid-Base Titration

Stoichiometric neutralization titrations, based upon the reaction that occurs between an acid and base.

### Activity

A physical property corresponding to the concentration of all ions in a solution. Electrodes respond to activity.

### Amperometric Titration

Titrations where the current flow between two electrodes (often a metal electrode and a reference electrode) are used to monitor the titration progress.

### Analyte

The chemical species being measured in a titration.

### Argentometric Titration

Titrations that use silver (nitrate) as the titrant. These titrations are typically precipitation titrations.

### Automatic Titrator

An instrument designed to automatically carry out a titration. It will add the appropriate amount of titrant, determine the endpoint and calculate the results.

### Back Titration

A type of titration where an excess amount of titrant is added to a sample, forcing a sluggish reaction to go to completion. The excess reagent is then "back" titrated with a second titrant.

### Base

A chemical species that can accept one or more protons (hydrogen ions).

### Biamperometric Indication

Uses a double platinum pin electrode to measure the current flow through a titration solution.

### Bivoltametric Indication

Uses a double platinum pin electrode to measure the voltage required to maintain a constant current flow through a titration solution while constant voltage is applied across the platinum elements of the electrode.

### Burette

A graduated cylindrical piece of laboratory glassware that is used to dispense precise amounts of solution.

### Complex Ion

A species where a central metal ion is covalently bonded to one or more electron donating groups called ligands.

### Complexometric Titrations

Metal ions are titrated using a titrant that binds strongly to it. The titrants often contain Ethylenediaminetetraacetic Acid (EDTA) or Cyclohexylenedinitrilotetraacetic Acid (CDTA).

## Endpoint

The point where a titration is stopped because a physical change in the solution has indicated a completed titration. Titration endpoints typically coincide with the equivalence point. A fixed value endpoint (pH or mV) can be used as well. The titration will stop at the desired point regardless if the titration is complete.

## Equivalence point

The point where the quantity of titrant is stoichiometrically equal to the quantity of analyte.

## Formal

The theoretical number of equivalents per liter of the solution. It is used in solutions where the exact concentration of a species may be affected by the other ions present, therefore the stated concentration may not be exactly correct.

## Gravimetric Analysis

A quantitative determination of an analyte based on the mass of the solid.

## Indicator Electrode

An electrode that responds to the species of interest. The electrode potential is proportional to the concentration or activity of that ion in the solution being measured.

## Indicators

Chemical indicators are typically organic dyes that change form under different physical conditions, causing a color change that can be seen by an analyst. Typically used in manual titrations, chemical indicators have been replaced with electrometric indicators, which are used with automatic titrators.

## Inflection Point

The point on a titration curve where the second derivative curve changes signs.

## Ion Selective Electrode (ISE)

An electrode that responds to a specific ion. The electrode potential is proportional to the concentration or activity of that ion in the solution being measured.

## Karl Fischer Titration

A titration that uses a chemical reaction that is specific for determining water.

## Manual Titration

A titration that is carried out by hand. The analyst must add the appropriate amount of titrant, determine the endpoint and calculate the results.

## Molar

The concentration of a solute in a solution.

## Mole (mol)

A quantity of a chemical species. The molecular weight of a substance in grams is equal to the mass of one mole of the substance. One mole is equal to  $6.022 \times 10^{23}$  atoms or molecules.

## Monochromator

A device that allows only a narrow range of wavelengths to pass through it by separating the light into different wavelengths.

## Multiple Endpoint Titration

A titration that reacts multiple species in solution sequentially using the same titrant. The concentration of each analyte can be determined from their respective endpoints.

## Nernst Equation

The fundamental equation relating cell voltage to the concentration of a solution.



# TITRATION THEORY

---

## Neutralization

A chemical reaction where an acid and a base react to form a neutral salt and water.

## Non-aqueous

A solution that does not contain water.

## Non-aqueous Titration

A titration that is performed in non-aqueous solutions, typically used to titrate very weak acids and bases to eliminate the leveling effect water has on all acids and bases dissolved in it.

## Normal

The concentration of a solution which accounts for any stoichiometric difference between the various species in a solution.

## Oxidation / Reduction Potential (ORP)

The measurement describing whether a species wants to donate or accept electrons from other species in a redox reaction. If a solution's reduction potential is higher than the species it is reacting with, it will typically gain electrons or be reduced. If the potential is lower than the species it is reacting with, it will typically lose electrons or be oxidized.

## Oxidant

The species that is accepting electrons in a redox reaction.

## Pipette

Scientific apparatus that is used to deliver precise volumes of liquids.

## Polyprotic Acid

Acids that are capable of donating more than one proton per acid molecule.

## Potentiometric Titration

A titration in which the endpoint is determined by monitoring the voltage of the solution using an electrode.

## Precipitation Titration

A titration in which the analyte reacts with the titrant to form an insoluble compound. The endpoint is typically detected with an ISE sensitive to either the analyte or titrant.

## Reagent

The chemical added in a titration that causes the given reaction to occur.

## Reduction-Oxidation Reaction (redox)

A chemical reaction in which the atoms involved in the reaction have their oxidation numbers changed. Reduction is the gain of electrons, which decreases the oxidation number. Oxidation is the loss of electrons, which increases the oxidation number.

## Reductants

The electron donor in a redox reaction.

## Reference Electrode

An electrode that supplies a constant electrode potential. It is used in combination with an "indicator" electrode, allowing for the "indicator" electrode potential to be measured.

## Relative Standard Deviation (RSD)

A measure of the amount of relative variation in a set of data. It is calculated by dividing the standard deviation by the mean:  $RSD = (\text{Standard Deviation of } X) * 100 / (\text{Mean of } X)$

**Repeatability**

The variation in sample measurements taken by a single person or instrument under the same conditions.

**Spectrophotometric Titration**

A titration in which the endpoint is marked by a change in the color and/or color intensity.

**Stoichiometry**

The quantitative relationship of the reactants and products in a chemical reaction.

**Titrant**

The chemical added in a titration that causes the given reaction to occur.

**Titration**

A quantitative, volumetric procedure used in analytical chemistry to determine the concentration of an analyte in solution. The concentration of the analyte is determined by slowly adding a titrant to the solution. As the titrant is added, a chemical reaction between the titrant and the analyte occurs.

**Titration Curve**

A graph containing the physical data obtained for a titration. The data plotted is often an independent variable (volume of titrant) vs. a dependent variable (pH of the solution). From the titration curve, the equivalence point or endpoint can be determined.

Titr THEORY 901/902

01/17