

GroLine

HI981412

pH Dosing System



INSTRUCTION MANUAL

 **HANNA**[®]
instruments

Dear
Customer,

Thank you for choosing a Hanna Instruments product.

Please read this instruction manual carefully before using this instrument.

This manual will provide you with the necessary information for correct use of this instrument, as well as a precise idea of its versatility.

If you need additional technical information, do not hesitate to e-mail us at tech@hannainst.com or view our contact list at www.hannainst.com.

All rights are reserved. Reproduction in whole or in part is prohibited without the written consent of the copyright owner, Hanna Instruments Inc., Woonsocket, Rhode Island, 02895, USA.

TABLE OF CONTENTS

1. PRELIMINARY EXAMINATION 4

2. SAFETY MEASURES 5

3. ABBREVIATIONS & CONVERSION CHARTS 5

4. SPECIFICATIONS 6

 4.1. HI981412 pH DOSING SYSTEM 6

 4.2. HI10063 pH & TEMPERATURE PROBE 7

5. DESCRIPTION 8

 5.1. GENERAL DESCRIPTION & INTENDED USE 8

 5.2. FUNCTIONAL & DISPLAY DESCRIPTION 9

6. INSTALLATION 13

7. SETUP 21

8. PUMP CONTROL 27

 8.1. AUTOMATIC CONTROL TYPES 27

 8.2. PRIMING THE PUMP 28

9. EVENTS MANAGEMENT 29

 9.1. ALARMS 29

 9.2. WARNINGS 30

 9.3. SUMMARY OF GENERAL BEHAVIOR 30

10. CALIBRATION 31

 10.1. pH CALIBRATION 31

 10.2. PROCESS pH CALIBRATION 33

 10.3. CLEAR CALIBRATION 34

11. MEASUREMENT 34

12. ERROR MESSAGES 35

13. MAINTENANCE 36

 13.1. ELECTRODE CARE & MAINTENANCE 36

 13.2. PUMP TUBING REPLACEMENT 36

14. ACCESSORIES 38

CERTIFICATION 40

RECOMMENDATIONS FOR USERS 40

WARRANTY 41

1. PRELIMINARY EXAMINATION

Remove the instrument and accessories from the packaging and examine it carefully. For further assistance, please contact your local Hanna Instruments office or email us at tech@hannainst.com. Each HI981412 is available in multiple configurations: controller and probe - HI981412-00, kit for in-line mounting - HI981412-10, kit for flow cell mounting - HI981412-20.

Each instrument is supplied with:

HI981412-00, without mounting kit

- HI10063 pH / temperature probe
 - 4.01 pH buffer solution, 20 mL (3 pcs.)
 - 7.01 pH buffer solution, 20 mL (3 pcs.)
 - Power connection cable
 - Instrument & electrode quality certificates
 - Instruction manual
-

HI981412-10, with in-line mounting kit

- HI10063 pH / temperature probe
 - Controller aspiration filter
 - Controller injector, ½" NPT thread
 - Saddle for Ø 50 mm pipe (2 pcs.)
 - 4.01 pH buffer solution, 20 mL (3 pcs.)
 - 7.01 pH buffer solution, 20 mL (3 pcs.)
 - Power connection cable
 - Instrument & electrode quality certificates
 - Instruction manual
 - PVC aspiration tubing (flexible)
length: 5 m
OD: Ø 6.0 mm; ID: Ø 4.0 mm
 - PE rigid dispensing tubing (pump to injector)
length: 5 m
OD: Ø 6.0 mm; ID: Ø 4.0 mm
-

HI981412-20, with flow cell mounting kit

- HI10063 pH / temperature probe
 - Flow cell for HI981412
 - Mounting panel assembly for HI981412
 - Controller aspiration filter
 - Controller injector, ½" NPT thread
 - Saddle for Ø 50 mm pipe (3 pcs.)
 - 4.01 pH buffer solution, 20 mL (3 pcs.)
 - 7.01 pH buffer solution, 20 mL (3 pcs.)
 - Power connection cable
 - Instrument & electrode quality certificates
 - Instruction manual
 - Rapid coupling ½" to 12.0 mm (2 pcs.)
 - Flow cell valve (2 pcs.)
 - PVC aspiration tubing (flexible)
length: 5 m
OD: Ø 6.0 mm; ID: Ø 4.0 mm
 - PE rigid dispensing tubing (pump to injector)
length: 5 m
OD: Ø 6.0 mm; ID: Ø 4.0 mm
 - PE rigid tubing (flow cell)
length: 10 m
OD: Ø 12.0 mm; ID: Ø 10.0 mm
-

OD: Outer Diameter; ID: Inner Diameter

Note: Save all packing material until you are sure that the instrument works correctly. Any damaged or defective item must be returned in its original packing material with the supplied accessories.

2. SAFETY MEASURES



- Always disconnect the pH pump controller from power when making electrical connections.



- Do not run other cables with the power cabling.
- Do not touch the metallic part. Hot surface.

3. ABBREVIATIONS & CONVERSION CHARTS

FDA	Food and Drug Administration	LED	Light Emitting Diode
NPT	American National Standard Taper Pipe Thread	PE	Polyethylene
ID	Inner Diameter	PVC	Polyvinyl Chloride
OD	Outer Diameter	REDOX	Reduction & Oxidation
		SPDT	Single Pole Double Throw

METRIC vs INCHES

Metric (mm)	Inches - Decimal	Inches - Fractional
4.0 mm	0.16"	$\frac{5}{32}$ "
6.0 mm	0.24"	$\frac{15}{64}$ "
10.0 mm	0.39"	$\frac{25}{64}$ "
12.0 mm	0.47"	$\frac{15}{32}$ "
20.0 mm	0.79"	$\frac{25}{32}$ "
25.4 mm	1.00"	1"
50.0 mm	1.97"	1 $\frac{31}{32}$ "
63.0 mm	2.48"	2 $\frac{31}{64}$ "
75.0 mm	2.95"	2 $\frac{61}{64}$ "

METRIC vs FEET & INCHES

Metric (m)	Feet (') Inches (")	Feet (')	Inches (")
2 m	6' 7"	6.56'	78.74"
5 m	16' 4"	16.40'	196.85"
10 m	32' 9"	32.80'	393.70"

4. SPECIFICATIONS

4.1. HI981412 pH DOSING SYSTEM

Range *	0.00 to 14.00 pH -5.0 to 105.0 °C (23.0 to 221.0 °F)
Resolution	0.01 pH 0.1 °C (0.1 °F)
Accuracy @ 25 °C (77 °F)	±0.10 pH ±0.5 °C (±0.9 °F)
Calibration	<ul style="list-style-type: none"> • User calibration: automatic, one or two-point with buffer solution (4.01, 7.01, 10.01 pH) • Process calibration: single point, adjustable (±0.50 pH around measured pH)
Temperature compensation	Automatic
High or Low mode Operation pump control	<ul style="list-style-type: none"> • On/Off control using adjustable set point (4.00 - 10.00 pH) with adjustable hysteresis (0.10 to 1.00 pH) • Proportional control using adjustable set point (4.00 - 10.00 pH) with adjustable proportional band (0.10 to 2.00 pH) • Startup delay timer at power-on (0 to 600 sec.) • Pump flow control 0.5 to 3.5 Liter/hour (0.13 to 0.92 Gallon/hour) and maximum output pressure 1 atm (14 psi) • Manual control for pump priming (defined in setup)
pH alarms	<ul style="list-style-type: none"> • High & Low with enable or disable option • Triggered after 5 sec. if the controller records consecutive readings over or under threshold values • Level with enable or disable option • Overtime protection (1 to 180 min. or Off)
Controller alarm system	<ul style="list-style-type: none"> • Intuitive alarm system, using red, yellow and green color coded backlight • User-selectable, alarm setup options
Alarm relay output	<ul style="list-style-type: none"> • SPDT 2.5A / 230 Vac • Activated by pH-selectable alarm conditions
Probe input	<ul style="list-style-type: none"> • Quick connect DIN connector • Galvanic isolation

* The range may be limited by the probe's limits.

Level sensor input (Digital input)	<ul style="list-style-type: none"> • External switches can be attached to stop the pump and activate the alarm (low reagent level) when the switch is open and level alarm is configured in Setup • Galvanic isolation
Power supply	100 - 240 Vac, 50/60 Hz
Power consumption	15 VA
Environment	0-50 °C (32-122 °F), max. 95% RH non-condensing
Dimensions	90 x 142 x 80 mm (3.5 x 5.6 x 1.8")
Weight	908 g (36 oz)
Casing	Wall mounted, built-in pump, IP65 rated

4.2. HI10063 pH & TEMPERATURE PROBE

Range	0 to 12 pH
Reference	Double junction
Junction	Cloth
Temperature sensor	Yes
Temperature range	-5 to 70 °C (23 to 158 °F)
AmpHel®	Yes
Matching pin	Yes
Body	PVDF (white)
Top thread	¾" NPT
In-line mounting thread	½" NPT
Cable length	2 m
Connector	Quick connect DIN connector
Maximum pressure @ 25 °C (77 °F)	3 bar (43.5 psi)

5. DESCRIPTION

5.1. GENERAL DESCRIPTION & INTENDED USE

HI981412 pH Dosing System is part of Hanna Instruments Groline family and features a pH controller with peristaltic dosing pump and a process sensor.

Maintaining the correct pH of plant soil or hydroponic nutrient solution is an ongoing task. Macro and micro nutrients as well as calcium and magnesium bloom boosters require the correct pH for absorption into the plants root system.

The HI981412 Groline pH Dosing System, easily assimilates into a nutrient/fertilizer system for soil and hydroponics. It precisely monitors the pH using the HI10063 waterproof pH/temperature probe; and simultaneously controls the addition of acid or base (Up and Down reagents) using On/Off or proportional control to fine tune and maintain the optimum pH. Growers can define the ideal set point for pH. The HI981412 is a small dosing controller and can be easily setup for a stand-alone nutrient reservoir or be part of a modular control scheme with the HI981413 Groline Nutrient Dosing controller. To obtain a representative sample pH, the probe should be located at a spot that experiences good circulation. The probe can be used in a "sample pot" or reservoir or installed in a flow cell or recirculation line; perfect for drain-to waste or recirculating systems.

Main Features

- Easy to read LCD display with intuitive, color-coded backlight
- Automatic Temperature Compensation: all readings are compensated for variations in temperature. Temperature is displayed in °C or °F along with pH reading. The pH probe contains an integral temperature sensor to simplify installation.
- High and low alarms: warn the user when the nutrient solution is out of desired range by blinking the LCD backlight red, disabling the pump, and deactivating the alarm relay
- Built-in peristaltic pump with On/Off or Proportional control
- Manual control for pump priming
- Overfeed protection using the overtime safety timer
- Resumes dosing on restart in case of power failure
- IP65 rated enclosure designed to withstand harsh environments
- Level input to stop control when nutrient levels are low
- Wall-mounted design
- User selectable languages
- Extremely easy to calibrate and use (prepackaged calibration standards)

The HI981412 Groline pH Dosing System is engineered to be an inexpensive solution for the horticulturist to have real-time monitoring and control of nutrient solutions, to obtain and maintain the ideal pH for optimum results at all times.

5.2. FUNCTIONAL & DISPLAY DESCRIPTION

Front Panel

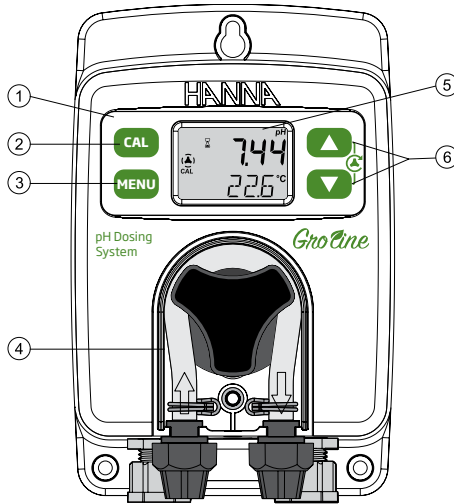

1. Keypad area
2. CAL key – Press calibration key to enter calibration mode.
3. MENU key – Press menu key to enter setup mode and move through the menu. Long press menu key to exit the menu and return to measurement.
4. Acid (or base) dosing pump
5. LCD display
6. Arrow keys – When in measurement mode, press the two arrow keys together to prime the pump.
 - When in menu mode, adjust settings.
 - When in menu mode (Control screen), press the arrow keys together and a 10 seconds pump test will start.

Liquid Crystal Display (LCD)

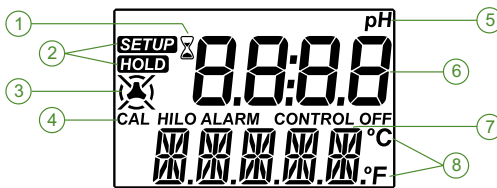

- | | |
|---|--|
| <ol style="list-style-type: none"> 1. Stability indicator 2. Mode tags 3. Dosing pump icon 4. Status indicators | <ol style="list-style-type: none"> 5. Measurement unit 6. First LCD line, measurement line 7. Second LCD line, temperature and message area 8. Temperature units |
|---|--|

Internal Rear Panel

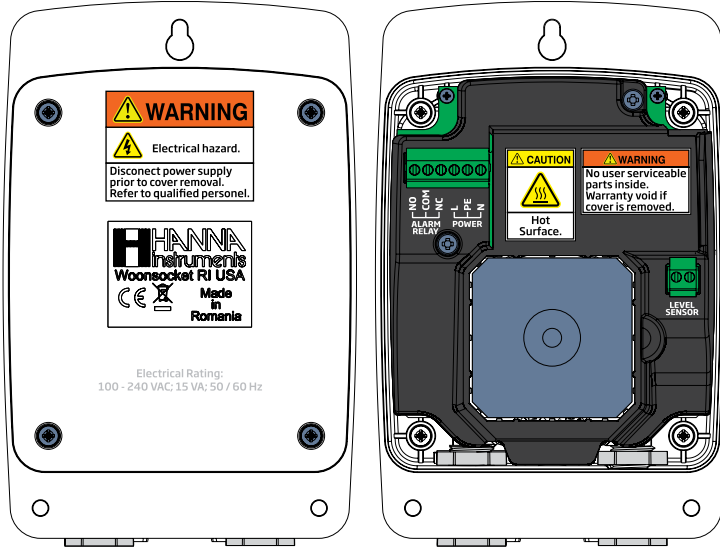

Use a Phillips head screwdriver and remove the four screws, pull back the cover and remove it.

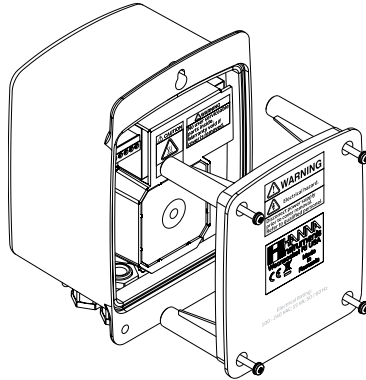

To replace the rear panel, insert the four legs back in place and tighten the four screws that secure the panel to the enclosure.

Alarm Relay, Power & Level Sensor

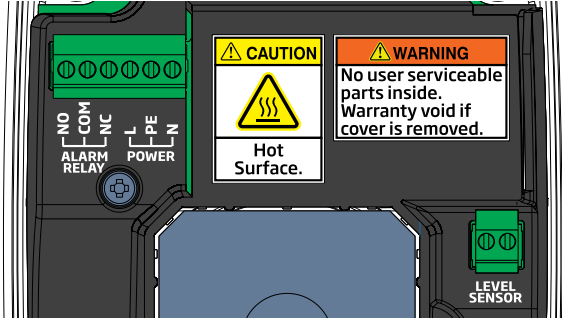

ALARM RELAY OUTPUT SPDT 2.5 A / 230 Vac	NO	Normally Open
	COM	Common
	NC	Normally Closed
	Pump controller not powered or Alarm condition	
	Working condition with no alarm	

POWER INPUT	L	Line – Hot connection
	PE	Protective Earth – Ground connection
	N	Neutral

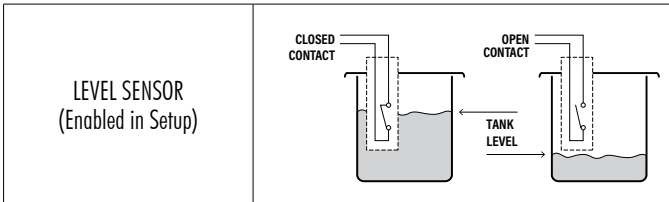

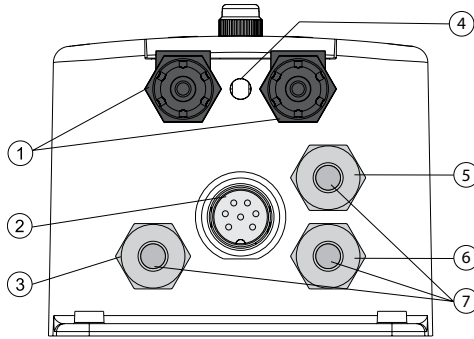

1	Tubing fittings
2	Sensor input
3	Cable gland for level sensor
4	Drainage opening
5	Cable gland for alarm cable
6	Cable gland for power cable
7	Enclosure cap

Cabling safety measures. Qualified personnel should perform wiring only.



- A disconnect switch must be installed to break all current carrying conductors. Turn off power before working on conductors.
- Always disconnect the pump controller from power when making electrical connections.
- Do not run other cables with the power cable through the cable gland.
- Always run all cables through cable glands to maintain IP65 rating and block unused holes with cable seal plugs.

6. INSTALLATION

General Guidelines

- Select controller location so that it is shielded from direct sunlight, dripping water and excess vibrations.
- Select the acid-dosing injector point away from the sampling point to prevent acids from damaging the probe or triggering an alarm.
- Keep flow rate as constant as possible for optimum sensor operation.
- Install cable gland fittings and plugs, to properly seal the pump controller.
- The probes are easily installed using ½" NPT threads for in-line or flow cell installation, and ¾" NPT thread for reservoir immersion installation.
- Ensure all tubing, cables, saddles and fittings are properly connected.

Note: *HI981412-10 and HI981412-20 Groline pH controllers are shipped with two types of tubing, for both flow cell and in-line configurations:*

- rigid tubing for outlet (dispensing) - connects the pump output to the injector
- flexible tubing for inlet (aspiration) - connects the filter to the pump inlet

Wiring Guidelines

Running cables through cable glands

- Unscrew the gland nut and remove the cap.
- Thread cable through outer opening of proper gland nut, through the seal, and into case.
- After connecting to terminal, reinsert seal and tighten nut on the threaded gland.

Connecting cables to the internal terminals

- Using a screwdriver, connect the cable leads to the appropriate terminal.
- Following the printed lead markings (L, PE, N for power supply; NO, COM, NC for relay; level sensor if required) ensure the leads are wired to the correct position.

Installation Steps

1. Check the acid tank level.
2. Calibrate the pH probe before installing in the system.
3. Mount the probe into saddle or into a flow cell.
4. Connect the aspiration tubing between the chemical tank and the pump's inlet.
5. Connect the dispensing tubing between the pump and injector.
6. Check the level sensor's functionality (if used).

Possible Installation Schemes for a Recirculating System

In-Line Installation, Overview & Parts Table

Below is an illustrated reference of a generic in-line installation scheme with the relevant components. The maximum pressure entering the flow cell system is 3 atm (44 psi).

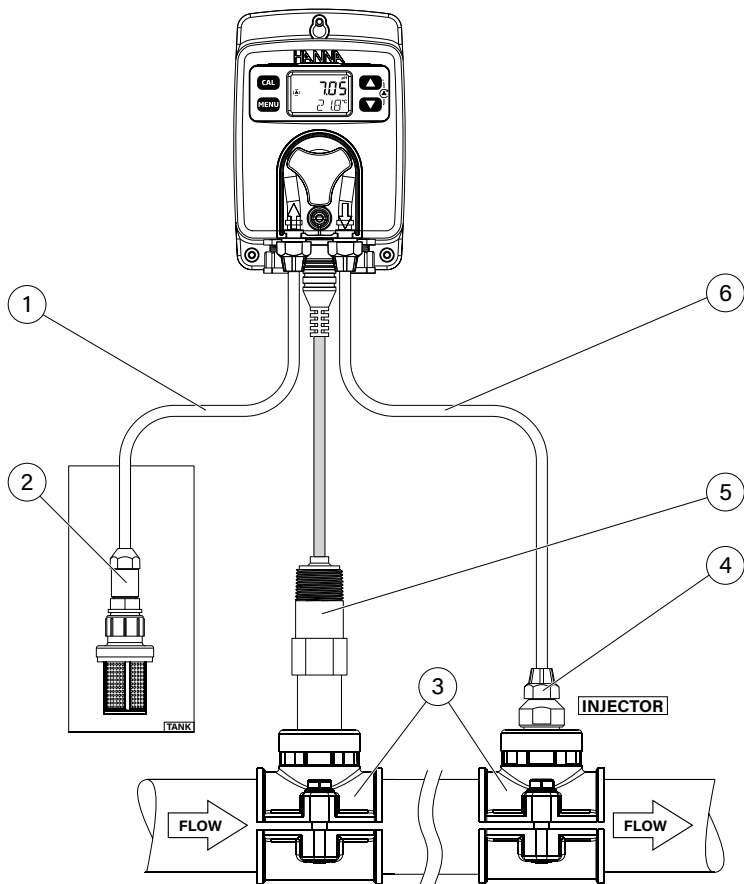

Note: Injectors prevent back flow into reagent tank.

1	Flexible PVC tubing \varnothing 6.0 mm and \varnothing 1/4"
2	Aspiration filter
3	Saddle for \varnothing 50 mm (2") pipe, using 1/2" NPT thread
4	Injector, 1/2" NPT thread
5	pH probe
6	Rigid PE tubing \varnothing 6.0 mm and \varnothing 1/4"

Flow Cell Installation, Overview & Parts Table

Below is an illustrated reference of a generic flow-cell installation scheme with the relevant components. The maximum pressure entering the flow cell system (P1) is 3 atm (44 psi) and decreases when it exits the flow-cell (P2). The maximum pressure for the pump (P3) is 1 atm (14 psi).

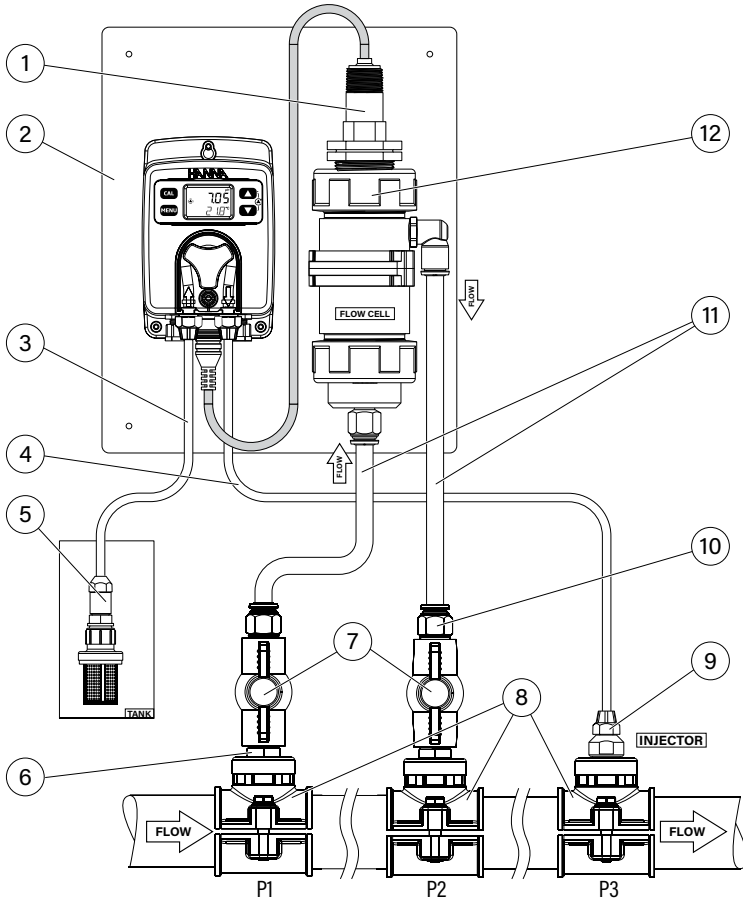

1	pH probe
2	Mounting panel
3	Flexible PVC tubing Ø 6.0 mm and Ø ¼"
4	Rigid PE tubing Ø 6.0 mm and Ø ¼"
5	Aspiration filter
6	Nipple, ½" to ½"
7	Valve to control flow-cell flow

8	Saddle for Ø 50 mm (2") pipe, using ½" NPT thread
9	Injector, ½" NPT thread
10	Adapter for tubing ½" to Ø 12.0 mm
11	Rigid PE tubing Ø 12.0 mm
12	Flow cell and adapter

Reservoir Immersion Installation

Detailed below a representation of a reservoir immersion installation scheme together with the relevant components and the pH probe screwed into the threaded end of a user supplied pipe and fastened with a bracket.

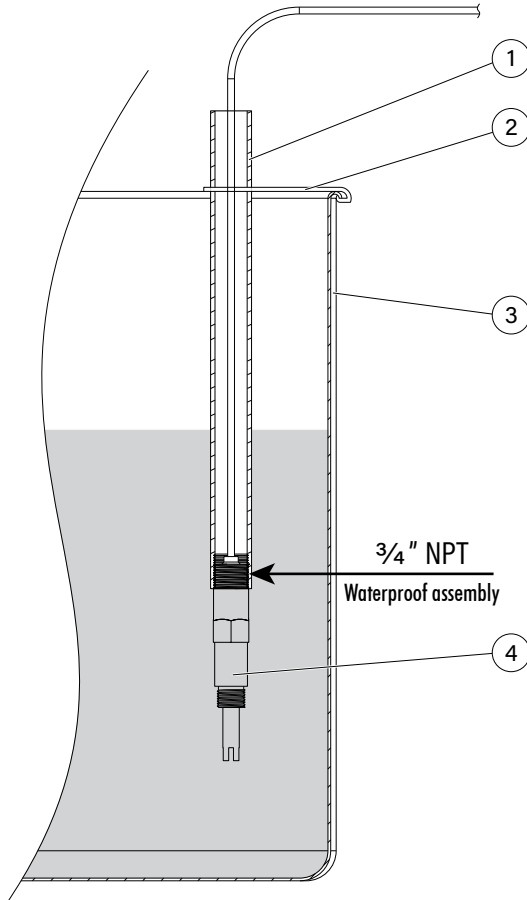

1	Electrode holder tube
2	Bracket
3	Reservoir
4	Probe

Note: It is recommended to keep the waterproof probe fastened during measurements and that only the probe body is continuously submerged.

Mounting Recommendations for Saddle

- Select required drill size. See table for dimension details.

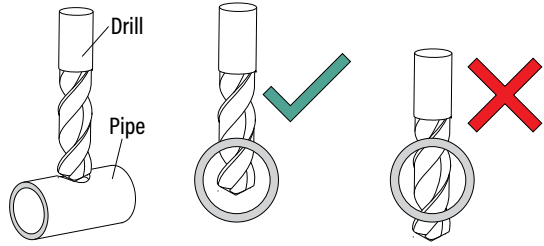

- Place the upper part of the saddle (3) on top of the pipe (5) with the seal (4) placed over the hole.
- Take the lower part of the saddle (6), together with inserted nuts (7) and align it under the upper part.
- Insert the screws (1) with washers (2) through the holes and tighten by hand into the mounted nuts.
- Using a wrench, tighten all screws carefully.

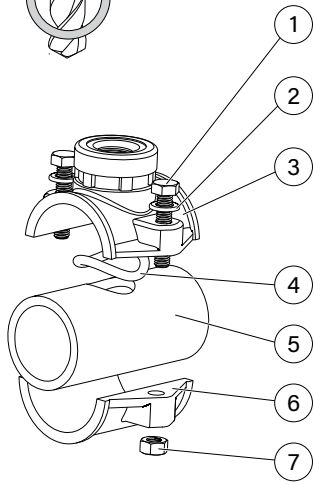

Saddle for probe & injector	Thread size	Drill size
Ø 50 mm pipe	½" NPT thread	20 mm - 25.4 mm
Ø 63 mm pipe	½" NPT thread	20 mm - 25.4 mm
Ø 75 mm pipe	½" NPT thread	20 mm - 25.4 mm

Connecting the Probe to the Pump Controller (In-line Configuration)

The probe should be connected to the controller and calibrated before installation.

To avoid twisting the cable, unplug probe from socket temporarily while installing in saddle.

Insert the probe and screw it carefully into the saddle, taking care not to damage the O-ring. Tighten the probe enough to ensure a tight seal.

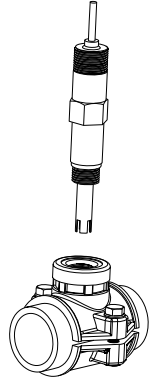

Installing Aspiration Filter

The aspiration filter is used in the reagent tank to filter and prevent debris from entering the tubing.

- Cut required length of aspiration tubing (flexible) to reach between peristaltic pump inlet and aspiration filter.
- Place the end of tubing on the filter.
- The compression fitting has to be screwed until secured on the filter.
- Slide the compression fitting from the peristaltic pump inlet onto the tubing.
- Slide the end of tubing over the fitting of the peristaltic pump tubing.
- Slide compression fitting up over tubing.
- Tighten the fitting.

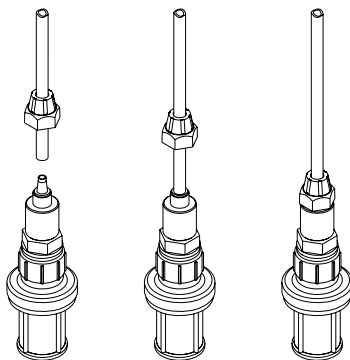

Installing Injector

- Cut the required length of dispensing (rigid) tubing to reach between injector saddle and outlet of peristaltic pump.
- Place the compression fitting nut on the tubing.
- Place the end of tubing on the injector.
- The compression fitting has to be screwed until secured on the injector.
- Screw the injector in the saddle.
- Slide compression fitting from pump tubing onto tubing.
- Slide the end of tubing over fitting of pump tubing.
- Slide compression fitting over tubing.
- Secure and tighten the fitting.

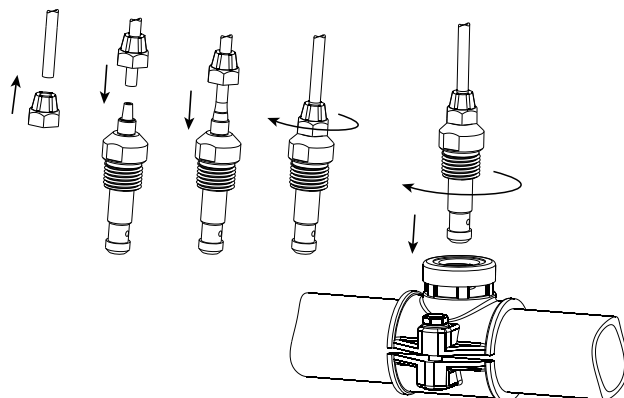

Flow Cell Installation

In a flow cell configuration, the water flows from the inlet valve to the flow cell and returns in the line via the outlet valve.

To prepare the inlet and outlet valve assemblies, as illustrated in the drawing:

- Mount the saddle (2) for flow cell inlet and outlet valve. Follow saddle mounting recommendations.
- Sparingly lubricate two O-rings (3) with a thin film of silicon grease and mount them on the nipple (1) on both sides.
- Screw the nipple in the saddle (3).
- Screw the valve (4) into the open end of the nipple mounted into the saddle. Make sure it is tight and the lever is forward facing so that it can be operated.
- Carefully screw the straight tubing fitting (5) into the valve, taking care not to damage the O-ring.
- Insert the tubing (6) in the straight tubing fitting (5).

1	Nipple
2	Saddle
3	O-ring
4	Valve
5	Tubing fitting
6	Tubing

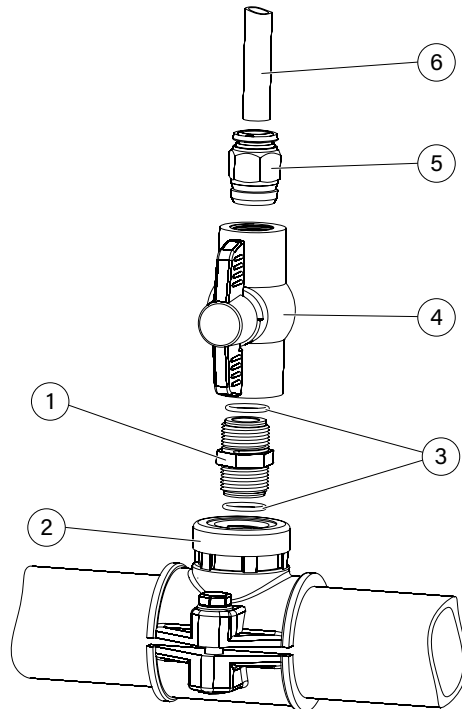

Connecting the Probe to the Flow Cell

- Remove the protective cap and verify the O-ring (2) is in place.

Note: The probe should be connected to the controller and calibrated before installation.

- To avoid twisting the cable, unplug probe from socket temporarily while installing in flow cell.
- Assemble the fixing nut (4) with the flow cell O-ring (5) inside the adapter (3). Tighten the adapter enough to seal in place taking care not to damage the O-ring (5).
- Carefully insert the probe (1) into the flow cell adapter (3), paying attention not to damage the adapter O-ring (2). Tighten the probe enough to seal in place.
- Cut the rigid PE tubing (9) to reach between flow cell inlet (bottom) and the pipe mounted outlet valve. Push the end of the tubing (9) into the tubing fitting (8).
- Repeat the previous step for flow cell outlet pushing the tubing (7) into the elbow tubing fitting (6).

1	Probe
2	Adapter O-ring
3	Adapter body
4	Adapter fixing nut
5	Flow cell O-ring
6	Elbow tubing fitting
7	Outlet rigid PE tubing 12.0 mm
8	Tubing fitting 12.0 mm
9	Inlet rigid PE tubing 12.0 mm

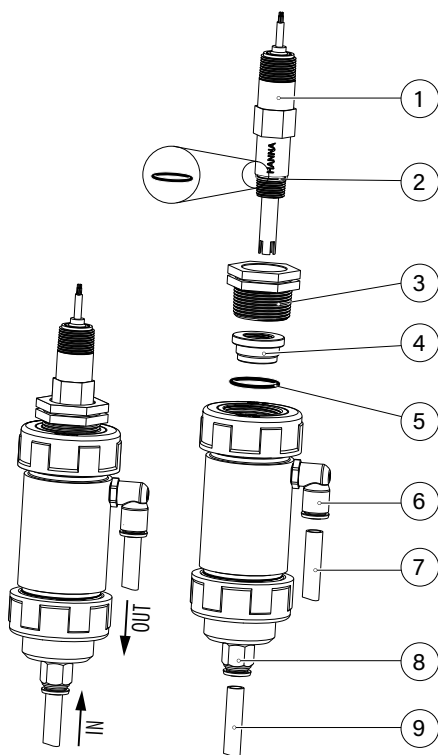

7. SETUP

- Short press MENU key to move to next item in menu.
- Long press MENU key to exit.
- Press arrow keys to change the values.
- Short press MENU key to automatically save modified values.

Table below presents an overview of the menu with ranges and factory set defaults.

Parameter (Scrolled message)	Range / Option	Default settings
Control	Auto or oFF	Auto
Control type	on/oFF or Proportional	on/oFF
Control mode	Hi or Lo	Hi
Set point	4.00 to 10.00	7.20
Hysteresis (on/oFF only)	0.10 to 1.00 pH	0.50
Band (Proportional only)	0.10 to 2.00 pH	1.0
Start up delay (seconds)	0-600	60
Overtime alarm (minutes)	oFF, 0-180	30
Flow rate (Liter/hour)	0.5 to 3.5	1.0
Flow rate (Gallon/hour)	0.13 to 0.92	0.26
Level alarm	diS or En	diS
High alarm	diS or En	En
High alarm value (pH)	0 to 14.00 pH*	10.00 pH
Low alarm	diS or En	diS
Low alarm value (pH)	0 to 13.90 pH*	4.00 pH
Temperature unit	°C or °F	°C
Flow rate unit	L.H or GAL.H	L.H
Language	En (English), ES (Spanish), Fr (French), Pt (Portuguese), nL (Dutch), dE (German)	En (English)

*Available range changes based upon other settings.

High alarm must be set higher than low alarm. If low alarm was set 7 pH, then high alarm range is 7.1 to 14 pH.

Control

Option: Auto or Off (oFF) to enable or disable the control

With disabled option oFF, the control is off.

Press one of the arrow keys for the controller settings to change from Auto to oFF and vice versa.

To run a ten-seconds pump test, long press the arrow keys together until the pump starts to run.

“CONTROL” message is scrolled on the bottom of the LCD screen.



Control Type

Option: On Off (on/oFF) or Proportional (ProP)

Press the arrow keys to switch between on/off and proportional options.

“CONTROL TYPE” message is scrolled on the bottom of the LCD screen.

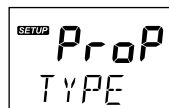
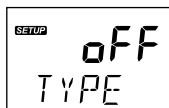
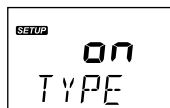

Note: To enter Control Type screen, pump control mode must be set as Auto.

Control Mode

Option: Low (Lo) mode or High (Hi) mode

Press the arrow keys to switch between the options.

“CONTROL MODE” message is scrolled on the bottom of the LCD screen.



Note: To enter Control Mode screen, pump control mode must be set as Auto.

Set point

General: a set point is a threshold value that will trigger control if the measurement value crosses it.

With a Hi control mode, the measurement approaches the set point from a lower measurement value.

With a Lo control mode, the measurement approaches the set point from a higher measurement value than the set point.

Option: user selectable

Press the arrow keys to assign the set point value.

“SET POINT” message is scrolled on the bottom of the LCD screen.

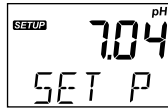

Note: To enter Set point screen, pump control mode must be set as Auto.

Hysteresis / Proportional Band

Hysteresis (On/Off Control only)

On/Off control action turns the dosing On or Off based on a previously assigned set point. The pump status (running or not running) changes depending on pH changes. To prevent oscillation, a pH band, called hysteresis, is created between the on and off operations.

The pump starts dosing when the measurement crosses the set point value. The pump stops dosing when the measurement crosses the set point value \pm hysteresis band.

In order to set the hysteresis value, automatic control must be enabled, with On/Off control type On.

Proportion band (Proportional Control only)

The proportional band is a control variable and is defined as the amount of change in input, required to cause the control output to go through 100% of operating range.

In order to set the proportional band value, automatic control must be enabled, with Proportional control type on. The pump is continuously on at the set point value with added band.

Option: user selectable

Press the arrow keys to set the value.

“HYSTERESIS” or “PROPORTIONAL BAND” message is scrolled on the bottom of the LCD screen.

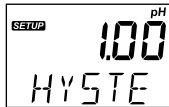

Note: To enter Hysteresis / Band screen, pump control mode must be set as Auto.

Startup Delay (Automatic Control Only)

Option: user selectable (0 to 600s)

Startup delay represents the delay to start dosing at power-on.

Press the arrow keys to change the time values.

“STARTUP DELAY SEC” message is scrolled on the bottom of the LCD screen.

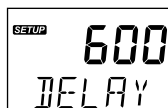

Note: To enter Startup Delay screen, pump control mode must be set as Auto.

Overtime Alarm

Option: user selectable (off, 1 to 180 minutes)

Press the arrow keys to change the time values. To disable the alarm, select Off. "OVERTIME ALARM MIN" message is scrolled on the bottom of the LCD screen.



Note: To enter Overtime alarm screen, pump control mode must be set as Auto.

Flow Rate

Option: user selectable (0.5 to 3.5 L/hour, 0.13 to 0.92 G/hour)

Press the arrow keys to change the values.

When in On/Off automatic control mode, the displayed value represents the actual flow rate.

When in Proportional automatic control mode, the displayed value represents a 100% flow rate.

"FLOW RATE L/H" or "FLOW RATE G/H" message is scrolled on the bottom of the LCD screen.

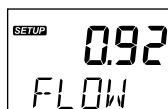
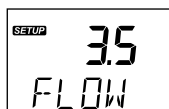

Level Alarm

Option: Enabled (En) or disabled (diS)

Press the arrow keys to switch between the options.

"LEVEL ALARM" message is scrolled on the bottom of the LCD screen.

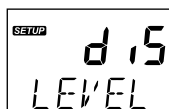

Note: Option can only be used with properly wired level sensor.

High Alarm

Option: Enabled (En) or disabled (diS)

Press the arrow keys to switch between the options.

"HIGH ALARM" message is scrolled on the bottom of the LCD screen.

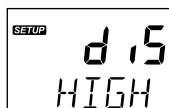

High Alarm Value

Option: user selectable

The range is influenced by the low-alarm value set (e.g. if low-alarm value is set as 5 pH, high-alarm value can be set from 5.10 pH and incremented up to 14.00 pH).

“HIGH ALARM VALUE” message is scrolled on the bottom of the LCD screen.



Note: The user can set the high-alarm value with high-alarm option enabled only.

Low Alarm

Option: Enabled (En) or disabled (diS)

Press the arrow keys to switch between the options.

“LOW ALARM” message is scrolled on the bottom of the LCD screen.

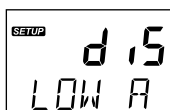

Low Alarm Value

Option: user selectable

The range is influenced by the high-alarm value set (e.g. if high-alarm value is set as 8 pH, low-alarm value can be set from 0.00 pH and incremented up to 7.90 pH).

“LOW ALARM VALUE” message is scrolled on the bottom of the LCD screen.

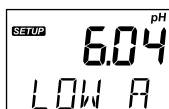

Note: The user can set the low-alarm value with low-alarm option enabled only.

Temperature Unit

Option: user selectable: °C or °F

Press the arrow keys to change the unit.

“TEMPERATURE UNIT” message is scrolled on the bottom of the LCD screen.

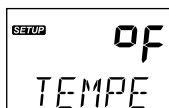
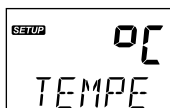

Flow Rate Measurement Unit

Option: Liter/hour (L.H) or Gallon/hour (GAL.H)

Press the arrow keys to switch between the options.

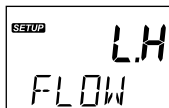

Languages

Option: select from: En (English), ES (Spanish), Fr (French), Pt (Portuguese), nL (Dutch), dE (German)

Press the arrow keys to change the language.

"LANGUAGE" message is scrolled on the bottom of the LCD screen.



Note: "LANGUAGE" message, scrolled on the second line, is translated into the selected language.

8. PUMP CONTROL

Pump control can be enabled, automatic control (AUTO) or disabled (off).

See SETUP section for further details on how to enable or disable pump control.

LCD backlight color indicates the pump control status:

- green - automatic control or in View menu mode
- yellow - disabled or in Edit menu mode

On the LCD screen, the pump status is displayed as below:

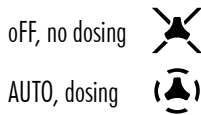

Startup Delay (Automatic Control Only)

When Startup Delay option is enabled, the controller is in Control Off mode for the set time; and the LCD backlight color is orange. The delay countdown will start upon powering the controller. At the end of the timing the LCD backlight turns green and the control mode is automatic (Auto).



8.1. AUTOMATIC CONTROL TYPES

There are two automatic control types: On/Off (constant) control and proportional control.

On/Off control

With On/Off control type for pH enabled in SETUP, the algorithm uses only "set point" and "hysteresis", both with user-selectable values. See SETUP section for further details.

High control mode: When the process pH drifts upward and it reaches a high set point, it triggers the reagent pump to turn on and acid can be added to decrease the pH. The pump will remain on until the pH has decreased to the set point value minus the hysteresis value. Then the pump will shut off.

Low Control mode: Conversely, with Low control mode, the process pH drifts down until it reaches a low set point. This triggers the pump to turn on and a base can be added to increase the pH. The pump will remain on until the pH has increased to the set point value plus the hysteresis value. Then the pump will shut off.

The typical application uses a high control point with the addition of an acid.

On/Off Control

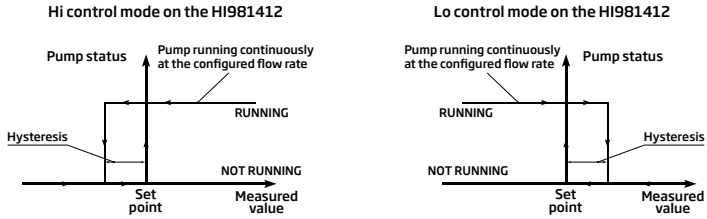

Proportional Control

With Proportional control enabled in SETUP, the dosing time depends on the difference between pH value and assigned set point.

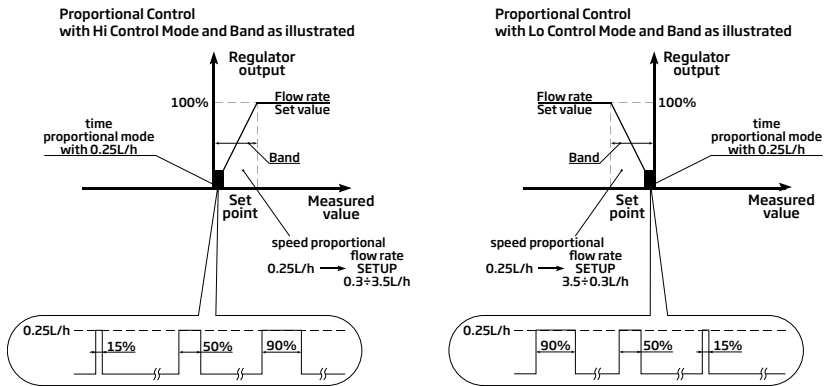

An overview of pH proportional control is presented in the graph below.

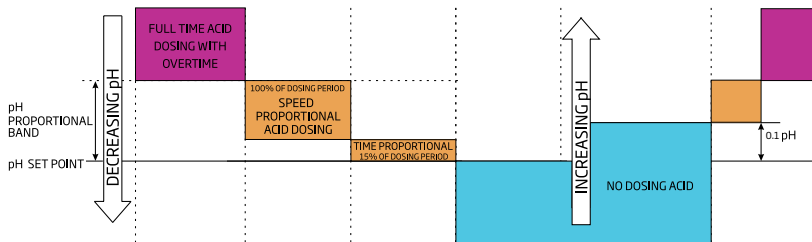

8.2. PRIMING THE PUMP

- From measurement mode, long press the arrow keys together to manually activate the pump.
- To exit, release the two keys.
- When there are no errors or active alarm, the LCD backlight is yellow.





9. EVENTS MANAGEMENT

9.1. ALARMS

Alarms can be independently enabled or disabled in SETUP.



Any event that activates the alarm turns automatic control Off, the alarm relay is deactivated and the LCD backlight is blinking red.

The table below illustrates the conditions that will activate the alarm and deactivate the control pump.





Alarm	Description	Alarm condition	Solution
Overtime alarm	Pump remains on continuously for the time set in menu Overtime Alarm setting		Control is switched off. Pump is activated in Manual mode.
Hold level alarm	Low-level sensor active		Refill chemical reagent container.
Low alarm	Measured pH is lower than the Low Alarm threshold value, for more than 5 seconds		Increase pH content of process to acceptable values.
High alarm	Measured pH is higher than set threshold alarm High pH, for more than 5 seconds		Decrease process pH content to acceptable values.

9.2. WARNINGS

Two types of warnings can be independently enabled or disabled in SETUP. If any of the warnings is active, the LCD backlight turns yellow.

Warnings	Description	Screenshot for warning solution	Terminate condition
Startup delay	Start up delay is active	 	Press the up / down arrows at same time to restart pump. Access pH, reagent levels to determine why pH level is off.
Control Off	Control is switched Off		Set Control setting to Auto

9.3. SUMMARY OF GENERAL BEHAVIOR

Behavior	Control	Backlight	Alarm Output Relay
Control - auto	auto	green 	off
Warning active	off	yellow 	off
Error active	off	red 	on
Alarm active	off	red (blinking) 	on

10. CALIBRATION

10.1. pH CALIBRATION

The HI981412 provides a digital calibration at the push of a button. Calibrate the probe frequently for improved accuracy. Also:

- before in-line or flow cell installation
- whenever the probe is replaced
- after periodic maintenance

Always use fresh calibration buffers and perform electrode maintenance prior to calibration (see ELECTRODE CARE & MAINTENANCE section).

Preparation

Pour the buffer solution into clean beakers. If possible, use plastic beakers to minimize any EMC interferences. For accurate calibration and to minimize cross-contamination, use two beakers, one for rinsing the probe and one for calibration.

User Calibration

One- or two-point calibration can be performed using one of the three standard buffer solutions: 4.01, 7.01 or 10.01 pH.

When a two-point calibration is required, use 4.01 pH buffer as first calibration point.

Procedure

- Press CAL key to enter calibration mode.
- Place the electrode in chosen pH buffer solution.
- Press CAL key to save calibration point and return to measurement screen.
- Long press MENU key to exit without saving.

One-Point Calibration

- Press CAL key to enter calibration mode. "pH 7.01 USE" message is displayed as calibration point.
- Place the electrode in 4.01, 7.01 or 10.01 pH buffer. The controller automatically recognizes the buffer value.
- When the buffer is recognized, "RECOGNIZED" is scrolled at the bottom of the LCD display. "WAIT" is displayed until the reading is stable and the calibration is accepted.



- If the buffer is not recognized (either because the pH electrode has not been placed in solution or the reading is outside accepted range), “---- WRONG” message is displayed along with CAL tag blinking.



- After pH 4.01 or 10.01 buffer is accepted, the “SAVE” message is displayed and the controller returns to measurement mode.



- The “CAL” tag is displayed automatically in measurement mode after a calibration has been performed.

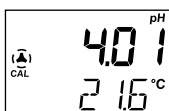

Note: To perform one-point calibration using pH 7.01 buffer, press CAL key after the buffer is saved.

Two-Point Calibration

- Follow One-Point Calibration section for one-point calibration using pH 7.01.
- After pH 7.01 has been accepted, the “pH 4.01 USE” message is displayed.
- Place the electrode in the second calibration buffer (pH 4.01 or 10.01); it will be automatically recognized. After the second buffer has been accepted, the “SAVE” message is displayed for 1 second and the controller returns to measurement mode.

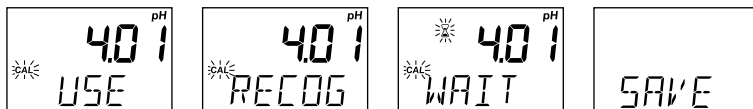

OR



- The “CAL” tag is displayed in measurement mode.



- If the buffer is not recognized, “---- WRONG” message is displayed. It is recommended to change the solution and / or clean the electrode.

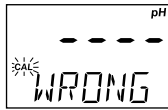

- Press CAL key to exit calibration.

Note: If high accuracy is required, a two-point calibration is recommended.

10.2. PROCESS pH CALIBRATION

Prior to performing a process calibration, determine the value using a reference meter. Make a note of the value.

Note: To enter process calibration, the user must have the controller and probe calibrated previously on the meter. The “CAL” tag must be on.

pH process calibration is a single point calibration performed while the probe remains installed in the process. The value can be set ± 0.50 around measured pH.

- Press CAL key to enter calibration mode. When the first buffer value is displayed, press one of the arrow keys to enter process calibration.

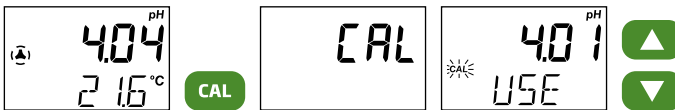

- Press the arrow keys again to adjust process calibration value to what was determined with the hand held measurement. “PROCESS” message is scrolled on the bottom of the LCD screen.

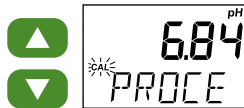

- Press CAL key to confirm the value (the “SAVE” message appears for a few seconds).
- Press MENU key to exit without saving and return to measurement mode (the “ESC” message is displayed for a few seconds).

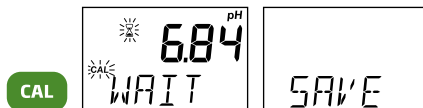

10.3. CLEAR CALIBRATION

- Press CAL key and the controller enters calibration mode.



- Long press MENU key and the “CLEAR” message is displayed.
- No “CAL” tag in measurement mode, indicates the probe is no longer calibrated.



11. MEASUREMENT

- Power the controller. All LCD segments will be displayed for a few seconds. After initialization has been completed, the controller displays the measurement screen.
- Plug the probe into the dedicated socket using the alignment notch to install properly.
- The pH electrode is automatically recognized. If the wrong probe is used, the controller will indicate an error.
- After setting up the controller menu, probe and all required accessories, the controller is ready for measurement.
- From measurement mode, press both arrow keys simultaneously to prime the pump and to verify the flow cell fills correctly (if used)
- If power is lost, then restored, the controller keeps the last used settings and calibration.
- If control mode is enabled (Auto), the pump tag will be displayed. If control is disabled (oFF), the pump tag will be crossed out.

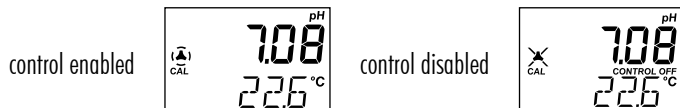

First LCD line displays measured pH value, the second LCD line displays the temperature. If a calibration was performed, the screen displays the CAL tag.

Measurements are updated every second and conditions are updated automatically. The pump starts or stops depending on configured settings (control mode and type, set point, hysteresis or proportional band, start up delay timer, overtime time, alarms).

12. ERROR MESSAGES

The pump controller shows error messages when erroneous conditions appear and when measured values are outside the expected range.

The information below provides an explanation of the errors, and recommended action to be taken. Error messages are displayed with red LED backlight.



Probe is not connected.
Connect the probe.

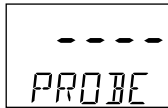

Wrong probe is connected.
Unplug the controller and connect the correct probe.



Broken temperature sensor.
Replace the probe.



Temperature is out of range.



Measured pH value is out of range.



Stepper motor error: over temperature or overcurrent is detected.

When the error has ceased, the stepper motor resumes normal function

13. MAINTENANCE

13.1. ELECTRODE CARE & MAINTENANCE

Proper care and maintenance of the pH probe is essential for accurate readings. Cleaning, calibrating, and appropriate storage will extend the life of the probe.

- Remove the electrode protective cap. Do not be alarmed if any salt deposits are present, this is normal. Rinse the probe with water.
- Shake the electrode down as you would do with a clinical thermometer to eliminate any air bubbles inside the glass bulb (pH electrode only).
- If the bulb and/or junction are dry, soak the electrode in HI70300 storage solution for a minimum of 30 minutes. Rinse with water.
- Calibrate before using.
- When the electrode is not in use, add a few drops of HI70300 storage solution to the protective cap and replace the cap. To ensure a quick response, the glass bulb (pH electrode) and the junction should be kept moist and not allowed to dry out. This can be achieved by installing the electrode in such a way that it is constantly in the flow cell or the pipe filled with the sample.

Note: Never store the electrode in distilled or deionized water.

13.2. PUMP TUBING REPLACEMENT

Note: While replacing tubing, wear protective gloves and eye protection at all times.

1. Power off the controller.

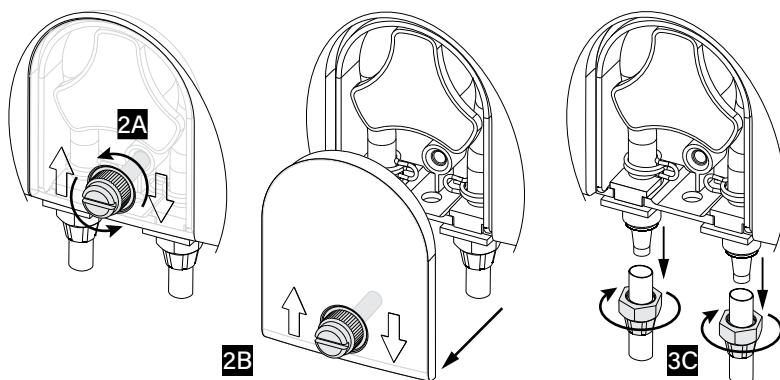

2. Remove the plastic screw securing the transparent cover (2A) and the cover (2B).
3. Disconnect the tubing from the pump (3C).

- Starting from the left side of the pump, grab the peristaltic pump tubing (4A) and rotate the pump rotor manually to the right (4B), until the tubing is removed (4C).
- Grease the new peristaltic pump tubing with silicone oil supplied in the peristaltic pump tubing kit (BL100-300).

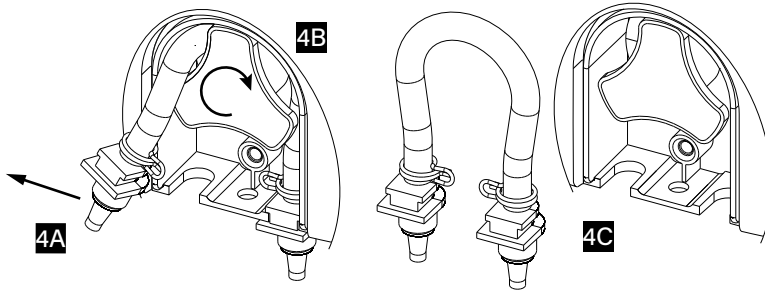

- Place the greased new peristaltic tube on the left side of the pump (6A) and rotate the pump rotor manually to the right (6B) until the tubing is on the pump. Fix the plastic holders on both sides (6C).

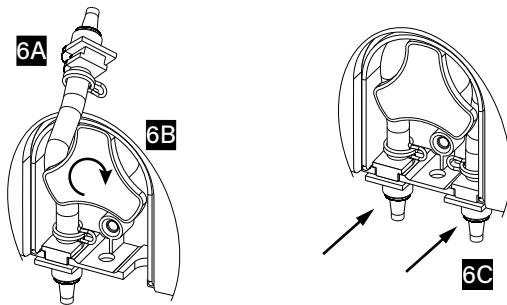

- Reattach the transparent plastic cover (7A) and secure it in place with the plastic screw (7B).
- Reattach the tubing to the pump (8C).

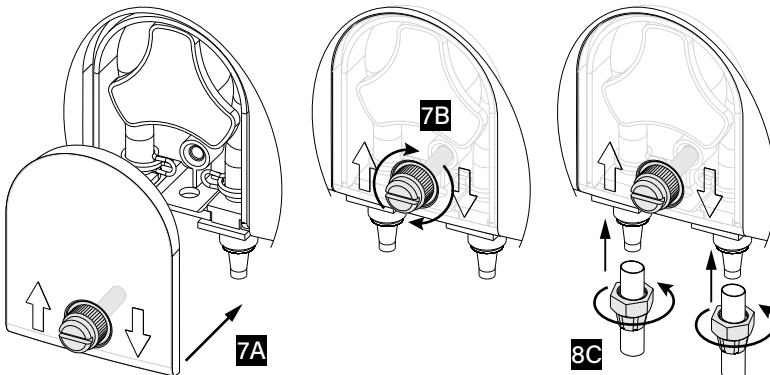

14. ACCESSORIES

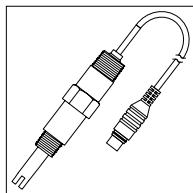

HI10063 pH/temp. probe with 2 m cable, DIN Quick connect

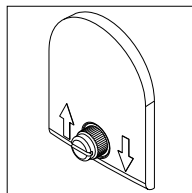

BL100-302 Pump cover with screw

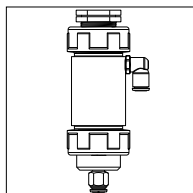

BL120-410 Flow cell for HI981412

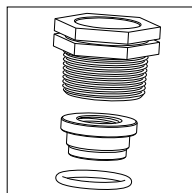

BL100-400 Probe adapter kit (contains adapter, fixing nut, O-ring)

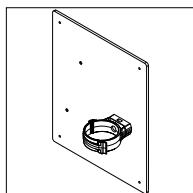

BL100-421 Flow cell panel

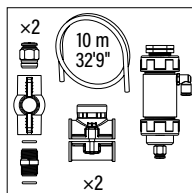

BL120-450 Flow cell kit for Ø 50 mm pipe

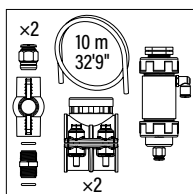

BL120-463 Flow cell kit for Ø 63 mm pipe

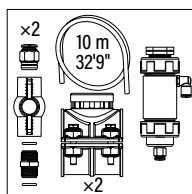

BL120-475 Flow cell kit for Ø 75 mm pipe

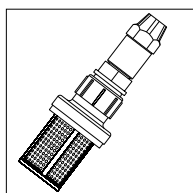

BL120-200 Controller aspiration filter

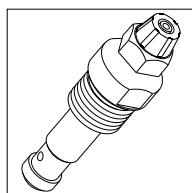

BL120-201 Controller injector, 1/2" NPT thread

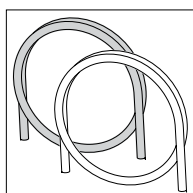

BL120-202 Aspiration and dispensing tubing 5 m (2 pcs.)

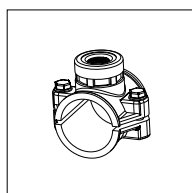

BL120-250 Injector saddle for Ø 50 mm pipe, 1/2" NPT thread

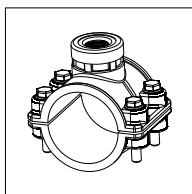

BL120-263
Injector saddle for
Ø 63 mm pipe,
½" NPT thread

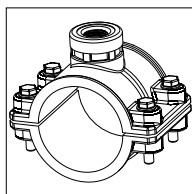

BL120-275
Injector saddle for
Ø 75 mm pipe,
½" NPT thread

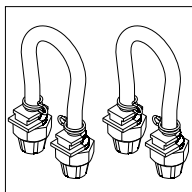

BL100-300
Peristaltic pump
tubing kit (2 pcs.)

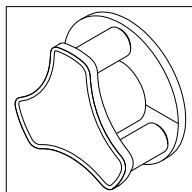

BL120-301
Peristaltic pump rotor

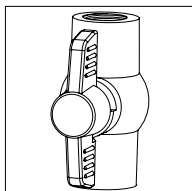

BL120-401
Flow cell valve

Other Accessories

HI70004G pH 4.01 buffer sachet (GroLine), 20 mL (25 pcs.)

HI70007G pH 7.01 buffer sachet (GroLine), 20 mL (25 pcs.)

HI70010G pH 10.01 buffer sachet (GroLine), 20 mL (25 pcs.)

HI7004-050 pH 4.01 buffer solution (GroLine), 500 mL

HI7007-050 pH 7.01 buffer solution (GroLine), 500 mL

HI7010-050 pH 10.01 buffer solution (GroLine), 500 mL

HI70300-050 Storage solution, 500 mL

HI7061-050 General cleaning solution (GroLine), 500 mL

HI740036P Plastic beaker set, 100 mL (10 pcs.)

CERTIFICATION

All Hanna Instruments conform to the **CE European Directives**.



Disposal of Electrical & Electronic Equipment. The product should not be treated as household waste. Instead hand it over to the appropriate collection point for the recycling of electrical and electronic equipment which will conserve natural resources. Ensuring proper product disposal prevents potential negative consequences for the environment and human health. For more information, contact your city, your local household waste disposal service, the place of purchase.



RECOMMENDATIONS FOR USERS

Before using this product, make sure it is entirely suitable for your specific application and for the environment in which it is used. Any variation introduced by the user to the supplied equipment may degrade the controller's performance. For yours and the controller's safety do not use or store the controller in hazardous environments.

WARRANTY

The HI981412 is warranted for two years (probes for six months) against defects in workmanship and materials when used for its intended purpose and maintained according to instructions. This warranty is limited to repair or replacement free of charge. Damage due to accidents, misuse, tampering or lack of prescribed maintenance is not covered.

If service is required, contact your local Hanna Instruments office. If under warranty, report the model number, date of purchase, serial number (engraved on the bottom of the meter) and the nature of the problem. If the repair is not covered by the warranty, you will be notified of the charges incurred. If the instrument is to be returned to Hanna Instruments, first obtain a Returned Goods Authorization (RGA) number from the Technical Service department and then send it with shipping costs prepaid. When shipping any instrument, make sure it is properly packed for complete protection.

Hanna Instruments reserves the right to modify the design, construction or appearance of its products without advance notice.

World Headquarters

Hanna Instruments Inc.
Highland Industrial Park
584 Park East Drive
Woonsocket, RI 02895 USA
www.hannainst.com



MAN981412

Printed in ROMANIA