

edge[®] pH



INSTRUCTION MANUAL

**Dear
Customer,**

Thank you for choosing a Hanna Instruments product.

Please read this instruction manual carefully before using the instrument.

This manual will provide you with the necessary information for correct use of the instrument, as well as a precise idea of its versatility.

If you need additional technical information, do not hesitate to e-mail us at tech@hannainst.com or view our worldwide contact list at www.hannainst.com.

All rights are reserved. Reproduction in whole or in part is prohibited without the written consent of the copyright owner, Hanna Instruments Inc., Woonsocket, Rhode Island, 02895, USA.

Included	4
Safety Measures	4
Description	5
Diagram	5
Product Diagram	5
Probe Diagram	7
Keypad Function	8
Guide to Indicators	9
Setup/Installation.....	10
Setting Up edge [®] pH	10
Electrode & Probe Connections.....	13
General Setup	14
Basic Mode.....	16
Logging Function	17
Viewing Logged Data.....	19
PC & Storage Interface.....	22
Operational Guide.....	24
Basic vs Standard pH Mode.....	24
pH Meter Configurations..	25
pH Calibration.	26
Calibration Messages.....	32
pH GLP Information.....	34
pH Measurement.....	36
Relative mV Calibration	37
Relative mV GLP Information.....	39
Relative mV Measurement	40
Maintenance	42
pH Probe Maintenance	42
ORP Probe Maintenance	45
Troubleshooting Guide	47
Specifications	48
Accessories.....	49

Remove the instrument from the packing material and examine it carefully to make sure that no damage has occurred during shipping. If there is any damage, please contact your local Hanna Instruments Office.

Each instrument **edge[®] pH (HI2002)** is supplied with:

- Bench cradle
- Wall cradle
- Electrode holder
- USB cable
- 5 VDC Power Adapter
- Instruction Manual
- Quality Certificate

HI11310: Digital pH Electrode with integrated temperature sensor
pH Calibration Solution Kit

Note: Save all packing material until you are sure that the instrument works correctly. Any defective item must be returned in its original packing.

Before using this product, make sure that it is entirely suitable for your specific application and for the environment in which it is used.

Operation of this instrument may cause interference to other electronic equipment, requiring the operator to take steps to correct interference. Any variation introduced by the user to the supplied equipment may degrade the instrument's EMC performance.

To avoid damages or burns, do not put the instrument in microwave ovens. For your and the instrument's safety, do not use or store the instrument in hazardous environments.

edge[®] pH enables the user to make fast, accurate measurements of commonly measured laboratory parameters using the Hanna Instruments edge[®] pH digital sensors for pH. Each digital sensor has a unique serial number. Once connected to the meter, the sensor(s) are ready to measure their parameter along with temperature.

The user interface permits you to adapt edge[®] pH to your exact measurement requirements. The intuitive design simplifies configuration, calibration, measurement, data logging and transfer of data to a USB thumb drive or computer. edge[®] pH also offers a basic operation mode that streamlines measurement configuration and is useful for many routine applications. (Every feature and measurement detail is designed to give you an edge in measurement technology.)

edge[®] pH is versatile in many ways. The slim meter and probe can be used as a portable device (using its rechargeable battery) or used in its bench or wall cradles (that also power the meter) as a line-powered laboratory instrument.

PRODUCT DIAGRAM

- Sleek, clean, intuitive design
- Internal clock and date
- Adjustable resolution
- Auto parameter recognition
- Dedicated GLP key
- GLP data included with logged data
- Basic mode for simplified operation
- Simplified data transfer to a PC
- Up to 8 hour battery life when used as a portable device

Side & Back View

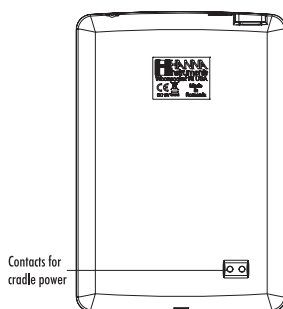

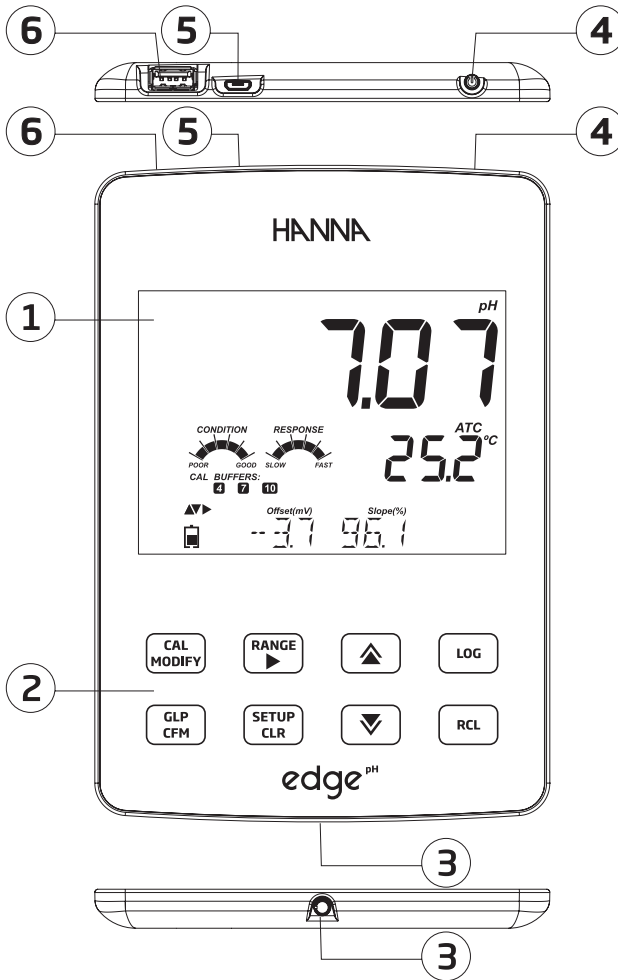

1. Liquid Crystal Display (LCD)
2. Capacitive Touch Keypad
3. 3 mm jack input for **edge[®] pH** digital probes
4. Top mounted ON/OFF button
5. Micro USB device connection for power or PC interface
6. Standard USB host connection for data transfer to a USB thumb-drive

PROBE DIAGRAM

Probe

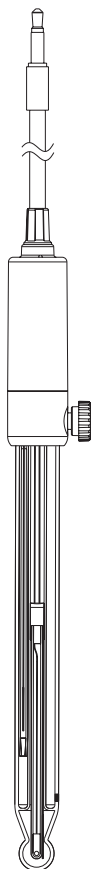

pH Electrode

- Probes process signal directly for noise free measurements
- Auto sensor recognition
- Store calibration specific data from the last calibration
- Are built with materials suitable for use in chemical analysis
- Have integrated temperature measurement
- Incorporate a 3 mm jack termination
- Unique serial ID in every probe for traceability

KEYPAD FUNCTION

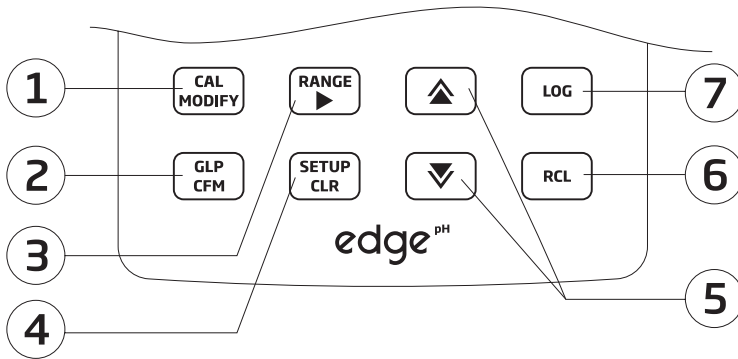

1. **CAL/MODIFY** - Used to enter and exit calibration mode. In SETUP, used to initiate changes of a configuration setting.
2. **GLP/CFM** - Used to display GLP calibration information. In SETUP, used to confirm change made. In calibration, used to accept calibration points
3. **RANGE/▶** - Used to select measurement range. In SETUP, used to move to right in pick list. In log RCL, used to view GLP data for a data point.
4. **SETUP/CLR** - Used to enter/exit SETUP mode. During calibration, used to clear previous calibration data. In log RCL, used to clear log records.
5. **▼/▲** - Used to scroll through SETUP menu. Used to change selection when modifying a parameter in SETUP.
6. **RCL (Recall)** - Used to view logged records or view % log memory used.
7. **LOG** - Used to log data by manual log on demand or manual log on stability or to start/stop interval logging.

*Note: You can increase/decrease the speed to change the value of a parameter. Proceed as follows:
Press and hold down the ▼/▲ key, then slide the finger toward the double apex to increase the speed that a value changes.*



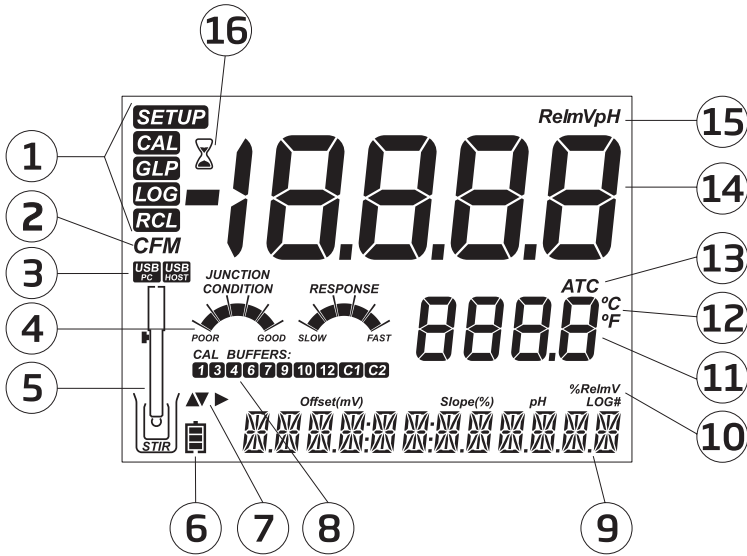

- | | |
|--|---|
| <ol style="list-style-type: none"> 1. Mode tags 2. Confirm tag 3. USB connection status 4. pH electrode diagnostics 5. Probes symbol 6. Battery symbol 7. Arrow tags, displayed when they are available 8. pH calibration buffers used | <ol style="list-style-type: none"> 9. Third LCD line, message area 10. Labels 11. Second LCD line, temperature measurement 12. Temperature units 13. Temp. Compensation status 14. Measurement line 15. Measurement units 16. Stability Indicator |
|--|---|

The third line of the LCD (9) is a dedicated message line. During measurement the user may use the ▼/▲ keys to select desired message. Options include date, time, calibration data, battery charge or no message. If a measurement error or log status change occurs during measurement, the third line will display a pertinent message.

SETTING UP edge[®] pH

The main operating modes of edge[®] pH are setup, calibration, measurement, data logging, and data export. Follow this general outline of steps to get you started. The following topics are expanded upon in the sections that follow in this manual.

1. Familiarize yourself with the design features of this unique meter.
2. Decide how the meter will be used and set up the wall or bench cradle in a clean area near line power.
3. Turn edge[®] pH on using the ON/OFF button located on the top of the meter.
4. Plug in the probe required for measurement.
5. SETUP the measurement parameters required for the measurement you will be making.
6. Calibrate the sensor/probe.

You are now ready for measurements.

Bench Cradle Setup

Insert electrode holder arm into the post on the pivoting base.

Connect the probe connector to the socket located at the bottom of the instrument.

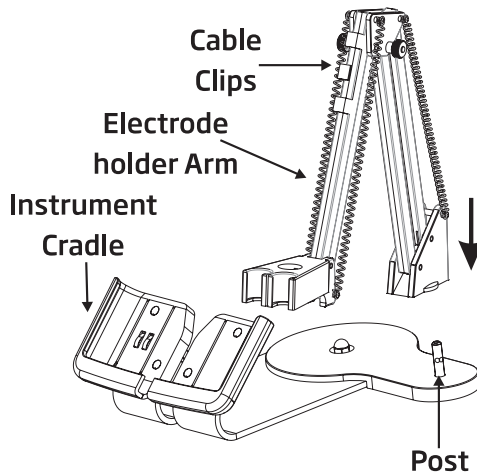

Slide **edge® pH** into the cradle while positioning the probe cable behind the cradle. Put the probe/sensor into the electrode holder and secure cable in clips.

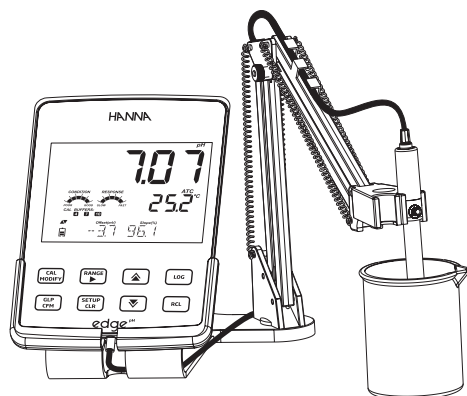

Connect the power adapter cable to the rear socket of the bench cradle. Connect the other end to the power adapter and plug into line power. Verify the battery icon indicates charging.

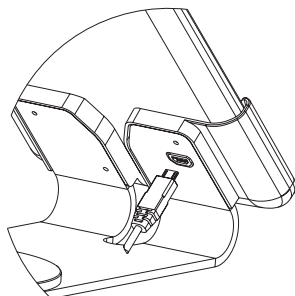

Wall Cradle Setup

Choose suitable wall location. (Use 2.5 mm or US #3 bit). Fasten the wall cradle using the provided screws. Snap cover over screw heads.

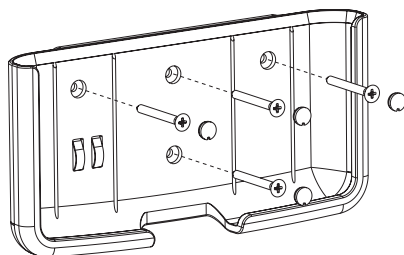

Connect the power adapter cable to the bottom socket of the wall cradle. Connect the other end to the power adapter and plug into line power.

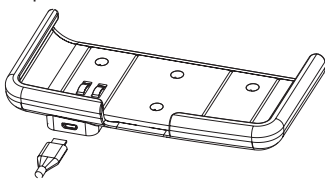

Connect the 3 mm probe jack to the socket located at the bottom of edge® pH. Slide edge® pH into the wall cradle. Verify the battery icon indicates charging.

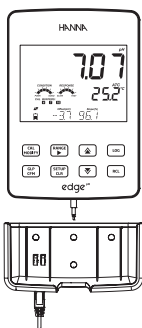

Power Connection

Alternatively to using the cradle for power, edge® pH can be powered by micro USB socket at the top. Plug the 5 VDC adapter into the power supply socket or by connecting directly to a PC.

Note: edge® pH is supplied with a rechargeable battery inside, which provides about 8 hours of continuous use. Whenever edge® pH is connected to the power adapter or to a PC, the battery is charging.

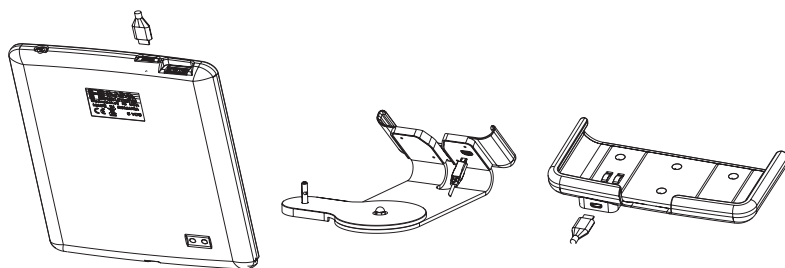

ELECTRODE & PROBE CONNECTIONS

Connect the 3 mm probe jack to the probe input located on the bottom of edge® pH. Make sure the probe is completely connected. If the probe is recognized, "CONNECTING" message is displayed along with sensor model.

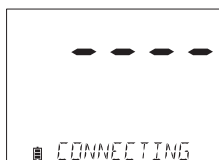

If the probe is not connected or not recognized, "NO PROBE" message is displayed.

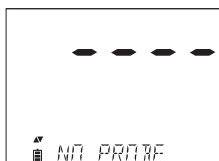

GENERAL SETUP

The following General Setup options are displayed regardless of the sensor being used. These settings remain when switching to another probe type or when no probe is attached. Options are tabulated in the table below with choices and default values. Options are accessed by pressing **SETUP/CLR** key. Loop through the options by using the **▼/▲** keys. To modify a setting, press **CAL/MODIFY** key. The option may be modified by using **RANGE/▶**, **▼/▲** keys. Press **GLP/CFM** key to confirm the change. To exit SETUP press **SETUP/CLR** key.

Option	Description	Choices	Default	Basic mode
*Only seen when cable connection between micro USB and PC is made.	Select if PC is being used for charging battery (and meter will be used for logging) or if Data will be exported to the PC.	LOG ON EDGE or EXPORT TO PC	LOG ON EDGE	Available
Log	Select log type to be used from 3 types of logging: Manual log on demand Manual log on stability (3 types of stability criteria available) Timed interval lot logging	Manual Log Stability Log: Fast, Medium, Accurate; Interval Log: Seconds: 5, 10, 30; Interval Log Minutes: 1, 2, 5, 15, 30, 60, 120, 180.	Interval (5 Sec)	Manual log or Stability log: Medium
Set Calibration Expiration Warning	Meter will indicate "CAL DUE" when set time in this parameter has been exceeded.	1, 2, 3, 4, 5, 6, 7 days or OFF	7 days	Not available
Probe Specific	Parameters that are specific to a measurement type are inserted here in the SETUP list.			
Set Date	Press CAL/MODIFY key to Set current date, displayed in ISO format. Press GLP/CFM key to save changes.	YYYY/MM/DD Date	Set date	Available
Set Time	Press CAL/MODIFY key to Set current time, displayed in ISO format. Press GLP/CFM key to save changes.	24 hr:MM:SS Time	Set time	Available

Option	Description	Choices	Default	Basic mode
Set Auto Off	Used to save battery life by automatically turning off when no key press is detected for time set and meter is not in active logging or calibration mode.	5, 10, 30, 60 Min or Off	10 MIN	Available
Sound	If enabled, a short audible tone is produced for key stroke or calibration confirmation and a longer tone for wrong key.	On or Off	On	Available
Temperature Unit	Select degree Celsius or Fahrenheit scale for displayed and logged temperatures.	°C or °F	°C	Available
LCD Contrast	Permits modification of the display contrast for various lighting conditions.	1 to 8	3	Available
Flash Format* Only seen when log errors are present.	Permits formatting the flash drive.	On or Off	OFF	Available
Message Transition	User may choose how messages are displayed on third LCD line of display.	Word scroll messages or letter scroll messages	Letter scroll messages	Available
Reset Config To Default	Press the CAL/MODIFY key and GLP/CFM key (when prompted) to reset parameters.			Available: RESETS with Basic Mode OFF.
Instrument Firmware/Probe Firmware	Displays firmware version of meter. Using the RANGE/▶ key switches to Probe firmware (if connected) and diagnostic made for troubleshooting.	View only	Current firmware version.	Available
Meter ID/ Meter SN/ Probe SN	User ID and Serial Number of meter and probe (if connected). Use RANGE/▶ to change between the three parameters.	Meter ID is user selectable	0000/Serial Number	Available

Note: Options that are seen under special conditions only.

BASIC MODE

edge® pH offers a basic operation mode that streamlines measurement configuration for pH measurements and is useful for many routine applications. Basic pH SETUP reduces parameter selection to the basic set. The meter limits calibration to 5 standard pH buffers: pH 6.86, 7.01, 4.01, 9.18 and 10.01 buffers. All pH measurements will display, log and export with 0.01 pH resolution. Interval logging is also eliminated. Manual and Manual medium stability log on demand are still functional. pH CONDITION, RESPONSE graphs are not displayed, giving the display a “Basic” measurement screen with just pH data and temperature.

If the log memory is full during any logging session, the “LOG FULL” message will be displayed on the third LCD line for a brief moment and logging will cease. The display will return to the measurement screen.

Note: If powering edge® pH through the micro USB connector to a PC, a SETUP option will require the choice “LOG ON EDGE” or “EXPORT TO PC”. 1000 log records can be stored into edge® pH memory. This memory is shared between all measurement types (pH, ORP) and all logging types (Manual, Manual Stability, Interval logs). The maximum number of records for an Interval lot is 600 records (provided log space is available). A record is a stored reading and a lot is a group of records.

LOGGING FUNCTION

Each time an Interval log is initiated, a new lot is created. The maximum number of Interval lots that may be stored is 100. If a 101st lot is attempted, "MAX LOTS" will be displayed. Some lots will need to be deleted. The lot numbering is up to 999 and restarts if all lot logs are deleted. All log on demand and stability log on demand are stored in a single lot. The maximum number of records that may be stored in a Manual or Stability lot is 200 records.

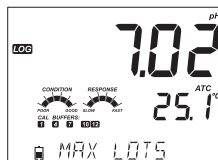

If the log memory is full during any logging session, the "LOG FULL" message will be displayed on the third LCD line for a brief moment and logging will cease. The display will return to the measurement screen.

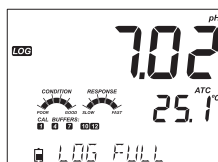

Logging type is configured in SETUP.

Types of Logging

Interval logging: A continuous log recorded using a user-selected timed period. (This is not available in Basic mode).

Manual log on demand: Readings are logged each time **LOG** key is pressed. All of the records are stored in a single Manual lot for the measurement type. New records made on different days are stored in the same Manual lot.

Manual Stability log on demand: A log on demand that is made each time **LOG** key is pressed and the stability criteria is reached. Stability criteria may be set to Fast, Medium or Accurate settings.

In Setup mode, choose log parameter, press **CAL/MODIFY** key then use **RANGE/▶** key to select between Interval, Manual, or Stability. When Interval is displayed, use **▼/▲** key to select the setting for the timed interval. When Stability is displayed, use the **▼/▲** key to select the measurement stability setting.

A complete set of GLP information including date, time, range selection, temperature reading, calibration information and probe serial number is stored with each log made.

Interval Logging

Select Interval and sampling period in the SETUP menu (Not available in Basic mode). To start Interval logging, press the **LOG** key while the instrument is in measurement mode.

A "PLEASE WAIT" message will be displayed followed by the number of free spaces. During active interval logging, lot information is displayed on the third LCD line. The line indicates in which lot the data will be placed and keeps track of the number of logged records taken. The "LOG" tag is continuously on during active logging.

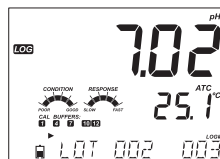

Pressing **RANGE/▶** key during an interval log will display the number of logs available.



Pressing the **LOG** key again will stop the Interval logging session. The "LOG STOPPED" message will be displayed for a few seconds.

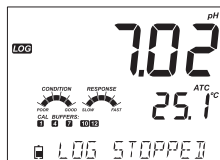

If a sensor failure occurs during interval logging, the message "OUT OF SPEC." will alternate with logging information.

Manual Logging

Select Manual in the SETUP menu. To initiate a Manual log, press the **LOG** key while the instrument is in measurement mode. The "PLEASE WAIT" screen will be displayed briefly followed by a screen indicating the measurement has been saved and then a screen indicating the log record number.

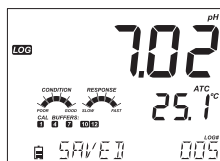

The "LOG" tag will be displayed on all 3 screens.

"PLEASE WAIT"

"SAVED" with the log record number

"FREE" with the number of free spaces available



Stability Logging

Select Stability and choose measurement stability criteria in the SETUP menu. Only Stability Medium is available in Basic mode. To initiate the Stability log, press the LOG key while the instrument is in measurement.

The "PLEASE WAIT" screen will be displayed briefly followed by a screen showing the stability tag, "LOG" tag and a "WAITING" message. The log can be stopped while the "WAITING" message is displayed by pressing LOG key again.

When the stability selected criteria has been met, a "SAVED" message will be displayed followed by a screen indicating how much log space is available. The "LOG" tag will be displayed on all 4 screens.

"PLEASE WAIT"

"WAITING"

"SAVED" with the log record number

"FREE" with the number of free spaces available

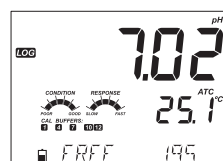
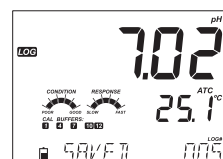
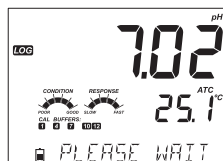

VIEWING LOGGED DATA

All log records stored on [edge® pH](#) may be viewed on the meter by pressing the RCL key. The log records are grouped according to measurement (pH, ORP).

The parameter displayed first is based on the probe/sensor connected. The display also indicates the percentage of log memory used. Press GLP/CFM key to display those logs.

Choices are:

- Manual log on demand lot,
- Manual log on stability lot,
- Individual Interval logging lots.

If no data was logged for the selected measurement range, the instrument displays the following messages (ex. for pH range):

"NO MANUAL LOGS"

"NO STABILITY LOGS"



- Press **GLP/CFM** key to enter inside lot information to view recorded data.
- Use the **▼/▲** keys to toggle between different records.
- Use **RANGE/►** key to display GLP data including calibration information, date, time, etc.
- Press **SETUP/CLR** key then **GLP/CFM** key when deleting records or lots.
- Press **RCL** key to exit the logging type.
- Press **RCL** key to exit the parameter selection screen.
- Press **RCL** key to return to the measurement screen.

Delete Logging Type/Lot

Press **RCL** key and select the parameter log.
 Use the **▼/▲** keys to select the Manual/Stability records or Interval lots to delete. Press **SETUP/CLR** key. The instrument will display "CLEAR MANUAL" for Manual Records, "CLEAR STAB" for Stability Records.



For Interval lots, the message "CLEAR", followed by the selected lot will be displayed with "CFM" tag blinking.

Press **▼/▲** keys to select a different lot. Press **GLP/CFM** key. The instrument will display "PLEASE WAIT".

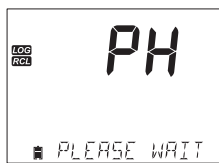

"CLEAR DONE" is displayed for a few seconds after the selected Interval lot is deleted.

Delete Records (Manual and Stability log on demand)

To delete individual records (Manual and Stability logs only), enter Manual (Stability) log by pressing **GLP/CFM** key when Manual (Stability) is displayed.

Use the **▼/▲** keys to select the record to be deleted and then press **SETUP/CLR** key.

The instrument will display "CLEAR REC." and record number along with "CFM" tag blinking. Use the **▼/▲** keys to select another record if necessary.



Press **GLP/CFM** key. The instrument will display "PLEASE WAIT" and then "CLEAR DONE" message. When individual logs are deleted within saved MANUAL or STABILITY logs, the logs will renumber, filling in the deleted data but staying in chronological order.

To delete all records of the MANUAL (STABILITY) log, proceed as described on page 20 for LOTS.

Select the Manual (Stability) lot and press **SETUP/CLR** key. The "CLEAR" message will be displayed along with "MANUAL" or "STABILITY" and "CFM" tag blinking on the LCD. Press the **GLP/CFM** key to confirm the deleting of the selected lot (MANUAL or STABILITY) or all records. Press **SETUP/CLR** key to exit without deleting.



The lot number is used to identify particular sets of data. The lot numbers are allocated successively until 100, even if some lots were deleted. The total number of lots that can be saved is 100. If some are deleted (for example 1-50), fifty additional logs may be stored. These will be numbered 101-150. The lots are allocated successively (provided available memory space) until 999 is reached. After this, it is necessary to delete all the LOT logs to start over the numbering.

Delete All

All pH logs, (or all ORP logs) may be deleted in a single clear. This function will delete all MANUAL, STABILITY and INTERVAL logs.

Press the **RCL** key. pH will be blinking. Use **RANGE/▶** key to select desired measurement parameter log data to delete (pH or ORP).



While the measurement type is blinking and message states "LOG RECALL", press **SETUP/CLR** key.

"CLEAR ALL" and measurement type will be displayed with "CFM" tag blinking. Press **GLP/CFM** key.



"PLEASE WAIT" and the percent cleared will be displayed until completed.



*Note: If **SETUP/CLR** key is pressed in error, press **SETUP/CLR** key again to exit without deleting.*



PC & STORAGE INTERFACE

Logged data on **edge® pH** can be transferred from the meter to a USB flash drive by using the log recall function. The minimum requirement for the drive is USB 2.0. Select the pH record you wish to export and follow the simple steps below.

Connect USB flash drive to the USB port, located on the top of the meter. Press the **RCL** key. Select Manual, Stability, or interval lots by using the **▼/▲** keys. Press the **LOG** key (not **GLP/CFM**). The “USB HOST” tag should come on.



“PLEASE WAIT” message appears followed by “EXPORT”. Press **GLP/CFM** key to export the selected record or lot. If **GLP/CFM** key is not pressed in 10 seconds, the USB host will become inactive.



The meter will display the percentage of export.

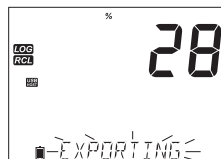

The export percentage should go to 100%. Remove USB flash drive.

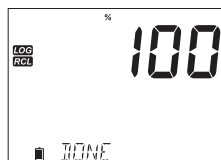

If the selected file is already saved on the flash drive, **edge® pH** will ask for confirmation of overwriting the existing file. The message “OVERWRITE” and “CFM” tag will blink. Press **GLP/CFM** key for overwriting the existing file or **CAL/MODIFY** key to exit without exporting.



After exporting the display will return to the selected file. Press the **RCL** key twice to return to measurements.



Note: Do not remove USB flash drive during an active export transfer.

Logged data on the **edge[®] pH** can be transferred from the meter to a PC by following these simple directions. Suitable operating systems include Windows (XP minimum), OS X or Linux.

1. Connect **edge[®] pH** to the PC using the supplied micro USB cable.
2. Turn on **edge[®] pH**.
3. Press **SETUP/CLR** key and select "LOG ON EDGE".
4. Press **CAL/MODIFY** key then use **▼/▲** keys to change to "EXPORT TO USB".
5. Press **GLP/CFM** key and the USB/PC Tag is displayed.
6. Press **SETUP/CLR** key to exit.

The PC should detect the USB as a removable drive. Open the drive to view the stored files. Log files are formatted as Comma separated values (*.CSV) and can be opened with any text editor or spreadsheet program.

Note: Western Europe (ISO-88859-1) character set and English language are suggested settings.

Other files may be visible depending upon computer settings. All files stored will appear in this folder.

Adjust Font or column width appropriately. Adjust the decimal places if the pH was logged with 0.001 resolution.

Interval logs are designated as pH or mV Lots. ie. PHLOT001, MVLOT002.

The Manual Lots are PHLOTMAN for pH and MVLOTMAN for ORP.

The Stability Lots are PHLOTSTAB for pH and MVLOTSTAB for ORP. All stability logs, regardless of stability setting, are located in the same stability file for that measurement.

Click on the desired log to view data.

Note: If "°C !" appeared in log data, the electrode/probe was used beyond it's operation specifications and the data is not considered reliable.

If "°C !!" appeared in log data, the temperature sensor within the probe or electrode is broken and the device should be replaced. Logged data should not be considered reliable.

For optimum pH measurements, follow these steps:

1. Understand the benefits and features of Standard and Basic Operation.
2. Set up **edge[®] pH** meter by configuring preferences.
3. Calibration.
4. Measurement.

BASIC VS STANDARD pH MODE

The “Standard” pH operation includes up to a 5-point buffer calibration, use of custom buffers, choice of displaying 0.001 pH resolution, use of the full diagnostic features of Calibration Check™ (that includes buffers used, probe condition, response time and messages indicating a contaminated buffer or pH sensor requiring maintenance during calibration). Additional Sensor Check™ indicators are available if using HI11311 or HI12301 pH electrodes. These include a continuous diagnostic to detect if the electrode is broken and at the time of calibration, a diagnostic to indicate the reference junction has been compromised or fouled by sample contamination. The Standard pH operation also includes full logging capability including Interval, Manual log on demand and Manual log on stability.

“Basic” pH operation provides a simplified SETUP menu; there are no decisions to make regarding the pH measurement itself. The meter will display 0.01 pH resolution and permit a 3-point buffer calibration from the following pH buffers: pH 4.01, 6.86, 7.01, 9.18 or 10.01. Calibration Check™ and Sensor Check™ features are limited to messages during calibration. Calibration reminders are also not available. The GLP will still provide offset, slope, buffers used and a calibration date. The Basic pH operation includes Manual log on demand and Manual log on stability (medium setting).

Note: When changing from Standard to Basic operation in SETUP, previous calibration data will be cleared. A prompt will force the user to facilitate this.

Major differences between Standard and Basic modes are shown below.

	Standard	Basic*
Calibration	5 points including 2 custom buffers	3 points
Diagnostics	Cal Check™ Feature Sensor Check™ Feature Error messages GLP	Basic error messages GLP basic
Log types	Manual Log on demand Manual Log on stability (Fast, Medium, Accurate) Interval Logging	Manual Log on demand Manual Log on stability (Medium)
Recommended pH electrodes:	HI11310, HI12300 HI11311, HI12301 HI10530, HI10430	HI11310* HI12300

*All sensors work in this mode, but diagnostic and all buffers will not be available.

pH METER CONFIGURATIONS

edge's pH meter operation is configured by using the **SETUP/CLR** key with a pH probe connected to the meter. The parameter-specific options will be seen inserted into the menu. If Basic mode is "On", the pH parameter list will not be displayed. See Basic mode for a description of this operation before choosing how to **SETUP** the meter.

Option	Description	Choices	Default	Basic mode
Basic Mode	When "On", a limited set of parameters and calibration buffers are available for use.	Off or On	Off	Available
Information	Visual indication of buffers used, Probe Condition and Response times are determined and displayed when calibration uses pH 7.01 and 4.01 and/or 10.01 buffers.	Off or On	On	Buffers used,probe conditions,and response times are not displayed.
First Custom Buffer	When "On", it permits the user to enter a custom pH buffer value to use during electrode calibration.	Off or value	Off	Not Available
Second Custom Buffer	When "On", it permits the user to enter a custom pH buffer value to use during electrode calibration.	Off or value	Off	Not Available
First Calibration Point	Allows the user to choose how the first point in calibration will be made.	Offset or point	Offset	Not Available (automatically uses Offset).
Resolution	Allows the user to select between 0.01 and 0.001 pH resolution	0.01 or 0.001 pH	0.01 pH	Not Available (automatically uses 0.01 pH resolution)
Set Out Of Calibration Range	When set to "On", a measurement that is outside the calibrated range (buffers used) will trigger a warning message.	Off or On	On	Not Available, No Error messages displayed.

pH CALIBRATION

Calibration in Standard Mode

pH operation in standard mode offers full function of **edge[®] pH**. This includes seven standard buffers and two custom ones. Five pH buffers may be used for calibration.

The instrument should be recalibrated whenever:

- High accuracy and sensor verification are required.
- The pH electrode is replaced.
- At least once a week.
- After testing aggressive chemicals.
- If "CAL DUE" is displayed on the third LCD line.

Every time you calibrate the instrument use fresh buffers and perform electrode maintenance as required. It is advised to choose calibration buffers that bracket the sample pH.

Preparation

Pour small quantities of the buffer solutions into clean beakers. If possible, use plastic to minimize any EMC interferences. For accurate calibration and to minimize cross-contamination, use two beakers for each buffer solution; one for rinsing the electrode and one for calibration. If you are measuring in the acidic range, use pH 7.01 or 6.86 as the first buffer and pH 4.01 (or 3.00*) as the second buffer. If you are measuring in the alkaline range, use pH 7.01 or 6.86 as first buffer and pH 10.01 or 9.18 as the second buffer.

* pH 3.00 is only visible when using specific pH electrodes and will replace 4.01 pH buffer.

Procedure

Calibration can be performed using up to five calibration buffers. For accurate measurements, a minimum of a three-point calibration is recommended. The calibration buffer can be selected from the calibration buffer list that includes the custom buffers and the standard buffers:

pH 1.68, 4.01 (pH 3.00), 6.86, 7.01, 9.18, 10.01 and 12.45.

The custom buffers allow the user to calibrate in a buffer solution different from a standard one. Two custom buffers can be set in SETUP menu. See page 28 for more information about using custom buffers.

The instrument will automatically skip custom buffers which are in a ± 0.2 pH window of an already calibrated buffer.

Submerge the pH electrode approximately 3 cm (1¼") into a buffer solution and stir gently. Press **CAL/MODIFY** key to enter calibration.

The "CAL" tag will appear and the "7.01" buffer will be displayed on the third LCD line. If necessary, press the ∇/\blacktriangle keys to select a different buffer value. The "⊗" along with "STIR" tag will be displayed and "WAIT" will blink on the LCD until the reading is stable.

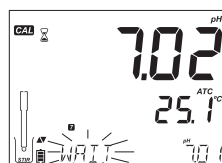

When the reading is stable and close to the selected buffer, "CFM" tag will blink. Press **GLP/CFM** key to confirm calibration.

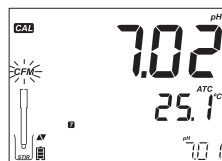

After confirming the first point, the calibrated value will be displayed on the first LCD line and the second expected buffer value on the third LCD line (i.e. pH 4.01).

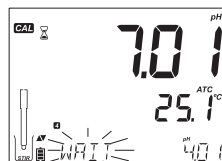

Rinse and submerge the pH electrode approximately 3 cm (1¼") into the second buffer solution and stir gently. If necessary, press the ∇/\blacktriangle keys to select a different buffer value.

The "⊗" along with "STIR" tag will be displayed and "WAIT" will blink on the LCD until the reading is stable.

When the reading is stable and close to the selected buffer, “CFM” tag will blink. Press **GLP/CFM** key to confirm calibration.

Repeat procedure with additional pH buffers. A total of five pH buffers can be utilized.

After confirming the last desired buffer calibration points, press **CAL/MODIFY** key (or if all five buffer values were calibrated) the instrument will automatically display “SAVING” as it stores information. It will then return to normal measurement mode.



Each time a buffer is confirmed, the new calibration data replaces the old data for the corresponding buffer or for any buffer in the proximity of ± 0.2 pH. If current buffer has no previous data stored and the calibration is not full (five buffers), the current buffer is added to the existing calibration. If the existing calibration is full, the instrument asks which buffer to replace.

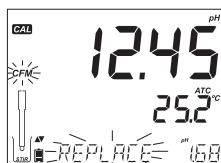

Press the ∇/\blacktriangle keys to select another buffer to be replaced.
 Press **GLP/CFM** key to confirm the buffer that will be replaced.
 Press **CAL/MODIFY** key to leave calibration without replacing.

Note: If the replaced buffer is outside the ± 0.2 pH window of the calibrated buffers, it is possible to select this buffer during the next calibration.

Working With Custom Buffers

If a custom buffer was set in **SETUP** menu, it can be selected during calibration by pressing the ∇/\blacktriangle keys. The “C1” or “C2” tag will bedisplayed once selected.

Press **RANGE/▶** key if you want to modify the custom buffer value. The buffer value will start blinking.

Use the ∇/\blacktriangle keys to change the buffer value. After 5 seconds, the buffer value is updated. Press **RANGE/▶** key if you want to change it again.

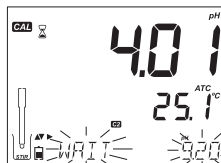

Note: Custom buffer values can be adjusted ± 1.00 pH around the set value during calibration. When a custom buffer is displayed, the “C1” or “C2” tag is displayed.

First Calibration Point

When performing a new calibration, or adding to an existing one, the user has a choice of how the first new calibration point will be treated in reference to the existing calibration point. This is selected in SETUP by the option FIRST CALIBRATION POINT. The two SETUP selectable options are "POINT" or "OFFSET".

Point: A buffer value can be recalibrated and added to the previous calibration set. The electrode slope of the other calibration points will be reevaluated with the recalibrated buffer value.

Offset: The new buffer calibration point can create a constant offset to all existing pH calibration data (existing calibration must have a minimum of two pH buffers).

Recalibrating a pH sensor or adding to an existing calibration is simple and follows the PROCEDURE outlined on page 26.

Press **CAL/MODIFY** key. Place sensor in desired buffer and select buffer from choices. When sensor has equilibrated, the "CFM" tag will turn on and blink. Press the **GLP/CFM** key.

Press **CAL/MODIFY** key to escape the calibration. Alternately continue calibrating in additional buffers. The latest calibration point will be added to the existing data. GLP will reflect the latest calibration data. Older calibration buffers will be seen as blinking buffers.

Note: Each time a buffer is confirmed, the new calibration data replaces the old data for the corresponding buffer or for any buffer in the proximity of ± 0.2 pH. If the current buffer has no previous data stored and the calibration has not used five buffers, the current buffer is added to the existing calibration. If the existing calibration is full, the instrument asks which buffer to replace.

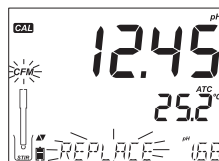

When using Standard mode, the user can choose if they want the display to show the CONDITION and RESPONSE gauges on the display. These are part of the Cal Check™ system and are selected in SETUP by the option INFORMATION. The choice is ON or OFF.

Electrode Condition and Electrode Response Time

edge® pH pH Calibration Check™ feature will assess electrode condition and response time during each calibration and display it for the rest of the day.

The condition gauge shows the electrode's condition that is based on the offset and slope characteristics of the pH electrode at the time of calibration. The response gauge is a function of the stabilization time between the first and second calibration buffers, when calibration is performed between a pair of pH 4.01, 7.01, or 10.01 buffers. These gauges reflect the electrode's performance and should be expected to slowly decrease over the life of the electrode .

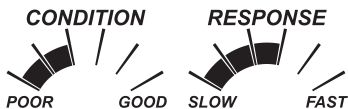

If the instrument is not calibrated the calibration history has been deleted, or it has been calibrated only at one point, the electrode condition and the electrode response gauges will be empty.

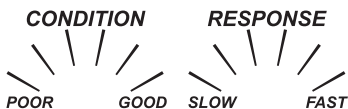

For a continuous display of the electrode's condition and response, daily calibration is necessary. This information can also be viewed in the GLP data.

Junction Condition (HI11311 and HI12301 Only)

edge's pH Sensor Check™ feature assess the health of the pH electrode's reference junction during each calibration. The junction gauge may be viewed directly in GLP but will also blink a warning on the display if the junction is compromised (not 100%). Should this happen, the junction condition will appear on the display with the junction blinking. The Junction Condition is a function of the electrode's reference impedance which should be kept low. If the reference junction becomes fouled from a precipitate or coating, the impedance will rise and cause the pH measurement to drift. This diagnostic feature serves as a warning to clean the sensor.



Calibration in Basic Mode Procedure

Basic mode operation permits up to three-point buffer calibration.

For accurate measurements, at least a two-point calibration is recommended. However, a single point calibration can also be used.

The calibration buffers can be selected from the calibration buffer list that includes the standard buffers, pH 4.01, 6.86, 7.01, 9.18 and 10.01.

Three-Point Calibration

Submerge the pH electrode approximately 3 cm (1¼") into a buffer solution and stir gently. Press **CAL/MODIFY** key. The "CAL" tag will appear and the "7.01" buffer will be displayed on the third LCD line. If necessary, press the **▼/▲** keys to select a different buffer value.

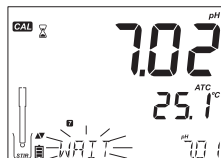

The “⌚” along with “STIR” tag will be displayed and “WAIT” will blink on the LCD until the reading is stable.

When the reading is stable and close to the selected buffer, the “CFM” tag will blink. Press GLP/CFM key to confirm calibration.

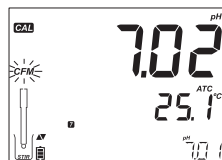

After confirming the first calibration point, the calibrated value will be displayed on the first LCD line and the second expected buffer value on the third LCD line. (i.e. pH 4.01)

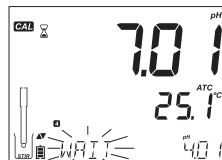

Rinse and submerge the pH electrode approximately 3 cm (1¼”) into the second buffer solution and stir gently.

If necessary, press the ▼/▲ keys to select a different buffer value.

The “⌚” along with “STIR” tag will be displayed and “WAIT” will blink on the LCD until the reading is stable. When the reading is stable and close to the selected buffer, the “CFM” tag will blink. Press GLP/CFM key to confirm calibration.

The calibrated value is then displayed on the first LCD line and the third expected buffer value on the third LCD line.

After the second calibration point is confirmed, rinse and submerge the pH electrode approximately 3 cm (1¼”) into the last buffer solution and stir gently.

If necessary, press the ▼/▲ keys to select a different buffer value.

The “⌚” along with “STIR” tag will be displayed and “WAIT” will blink on the LCD until the reading is stable.

When the reading is stable and close to the selected buffer, the “CFM” tag will blink. Press GLP/CFM key to confirm calibration.

At the end of calibration the instrument displays “SAVING”, stores the calibration value and returns to normal measurement mode.

The calibration sequence may be reduced to two buffer values or a single one. Press CAL/MODIFY key to return to measurement mode after the desired number of buffers have been calibrated.

Note: When performing a new calibration or adding to an existing calibration the first calibration point will be treated as an offset. See page 29 for details.

Press CAL/MODIFY key after the first or second calibration point are confirmed and the instrument will store the calibration data. Then it will return to measurement mode.

If the value measured by the instrument is not close to the selected buffer, “WRONG BUFFER” will blink. Check if the correct buffer has been used, or clean the electrode by following the Cleaning Procedure. If necessary, change the buffer or the electrode.

If the buffer temperature exceeds the temperature limits of the buffer, “WRONG BUFFER TEMPERATURE” will be displayed.

Press SETUP/CLR key after entering calibration to clear all calibration options. “CLEAR ALL” message will be displayed and the instrument will return to measurement mode displaying “CAL DUE” message.

pH Buffer Temperature Dependence

Temperature has an effect on pH. The calibration buffer solutions are affected by temperature changes also. During calibration the instrument will automatically calibrate to the pH value corresponding to the temperature. During calibration the instrument will display the pH buffer value at 25 °C.

TEMP		pH BUFFERS								
°C	°F	1.679	3.000	4.010	6.862	7.010	9.177	10.010	12.454	
0	32	1.670	3.072	4.007	6.982	7.130	9.459	10.316	13.379	
5	41	1.670	3.051	4.002	6.949	7.098	9.391	10.245	13.178	
10	50	1.671	3.033	4.000	6.921	7.070	9.328	10.180	12.985	
15	59	1.673	3.019	4.001	6.897	7.046	9.273	10.118	12.799	
20	68	1.675	3.008	4.004	6.878	7.027	9.222	10.062	12.621	
25	77	1.679	3.000	4.010	6.862	7.010	9.177	10.010	12.450	
30	86	1.683	2.995	4.017	6.851	6.998	9.137	9.962	12.286	
35	95	1.688	2.991	4.026	6.842	6.989	9.108	9.919	12.128	
40	104	1.693	2.990	4.037	6.837	6.983	9.069	9.881	11.978	
45	113	1.700	2.990	4.049	6.834	6.979	9.040	9.847	11.834	
50	122	1.707	2.991	4.062	6.834	6.978	9.014	9.817	11.697	
55	131	1.715	2.993	4.076	6.836	6.979	8.990	9.793	11.566	
60	140	1.724	2.995	4.091	6.839	6.982	8.969	9.773	11.442	
65	149	1.734	2.998	4.107	6.844	6.987	8.948	9.757	11.323	
70	158	1.744	3.000	4.123	6.850	6.993	8.929	9.746	11.211	
75	167	1.755	3.002	4.139	6.857	7.001	8.910	9.740	11.104	
80	176	1.767	3.003	4.156	6.865	7.010	8.891	9.738	11.003	
85	185	1.780	3.002	4.172	6.873	7.019	8.871	9.740	10.908	
90	194	1.793	3.000	4.187	6.880	7.029	8.851	9.748	10.819	
95	203	1.807	2.996	4.202	6.888	7.040	8.829	9.759	10.734	

CALIBRATION MESSAGES

The Calibration Check™ feature may flag diagnostic messages during a calibration. As electrode aging is normally a slow process, substantial changes from previous calibrations are likely due to a temporary problem with the electrode or buffers that can be addressed easily. These messages are seen in Standard and Basic modes.

Wrong Buffer

This message appears when the difference between the pH reading and the value of the selected buffer is too great. If this error message is displayed, check if you have selected the proper calibration buffer and have poured the desired buffer.

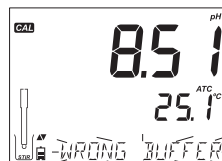

Wrong Old Points Inconsistency

"WRONG OLD POINTS INCONSISTENCY" is displayed if the new calibration differs significantly from the last value of that sensor in that buffer. In this case it may be best to clear the previous calibration and attempt a new calibration with fresh buffers.

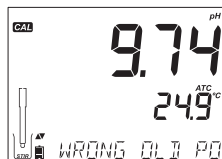

To clear calibration information, press **CAL/MODIFY** key then press **SETUP/CLR** key. The "CLEAR CALIBRATION" message will be displayed. Either press the **GLP/CFM** key and clear all calibration information or press **CAL/MODIFY** key to exit to keep old calibration data instead of clearing.

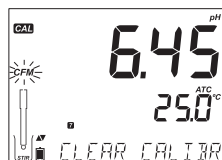

Once calibration information is cleared, the message "CAL DUE" will be displayed



Clean Electrode

"CLEAN ELECTRODE" indicates poor electrode performance (offset out of accepted window, or slope under the accepted lower limit). Often, cleaning the sensor will improve the pH electrodes response. See pH Electrode Conditioning and Maintenance for details. Repeat calibration after cleaning.

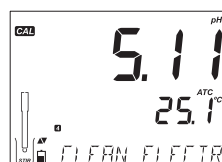

Check Electrode Check Buffer

"CHECK ELECTRODE CHECK BUFFER" appears when electrode slope exceeds the highest accepted slope limit. You should check your electrode and use fresh buffer. Cleaning may also improve this response.

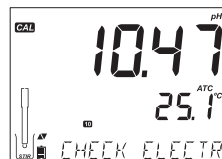

Bad Electrode

“BAD ELECTRODE” appears if the cleaning procedure performed as a result of the above two messages is found to be unsuccessful. In this case it is advised to replace the electrode.

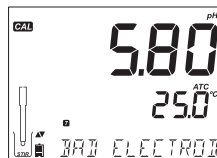

Wrong Buffer Temperature

“WRONG BUFFER TEMPERATURE” appears if the temperature of the buffer is outside the defined buffer temperature range. The calibration buffer solutions are affected by temperature changes in a defined manner. During calibration, the instrument will automatically calibrate to the pH value corresponding to the measured temperature but display it to the value at 25 °C. Immediately after calibration, the buffer should read the value of the buffer at the temperature of measurement.

Note: Temperature limits will be reduced to actual sensor specifications.

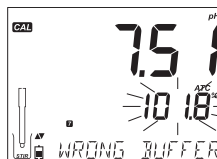

Contaminated Buffer

“CONTAMINATED BUFFER” appears in order to alert that the buffer could be contaminated. Refresh your buffer and continue the calibration procedure.

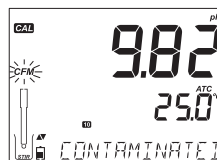

Broken Temperature Sensor

If the temperature sensor should malfunction or break at any time, a temperature of “25.0 °C” will blink on the second LCD line and the message “BROKEN TEMPERATURE SENSOR” will appear on the third LCD line after leaving calibration. The calibration will have the compensation at 25 °C.

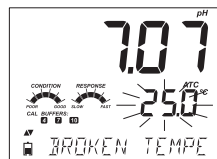

Note: If this occurs during logging “25 °C !” will appear in the CSV file.

pH GLP INFORMATION

Good Laboratory Practice (GLP) refers to a quality control function used to ensure uniformity of sensor calibrations and measurements. The dedicated **GLP/CFM** key opens a file of the latest calibration information. Use the **▼/▲** keys to scroll the stored information. This includes the buffers used, temperature of the buffer, time and date of the last calibration, the sensor serial number and the calculated offset and percent slope. This information is available in Basic and Standard Modes. This information is also included with every data log. Newest calibration points report as a solid number, older calibration data (that is still used) will be displayed blinking.

If calibration has not been performed, the instrument displays a blinking “NO CAL” message.



After the calibration has been performed the instrument displays offset and slope. The GLP slope is the average of the calibration slopes; the percentage is referenced to the ideal slope value at 25 °C. Additionally the condition and response indicators displayed are from the last calibration.

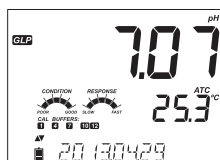
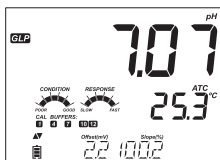

Pressing the ∇/\blacktriangle keys, the last calibration date (yyyy.mm.dd) together with the current reading is displayed.

Note: If a custom buffer was used in calibration, the “C1” and “C2” tags will be displayed. If only the one custom buffer is used in calibration, the tag will be “C1” and the value will be displayed.

If disabled, “EXPIRATION WARNING DISABLED” is displayed.

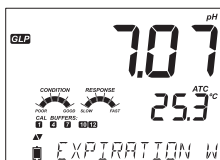

Or if enabled the number of days until the calibration alarm “CAL DUE” will be displayed. (i.e. “CAL EXPIRES IN 2 DAYS”)



The number of days since the calibration expired. (I.E. “CAL EXPIRED 2 DAYS AGO”).

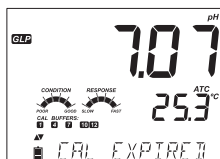

The probe serial number together with the current reading.



If a buffer is not from the last calibration, the buffer tag will be displayed blinking.

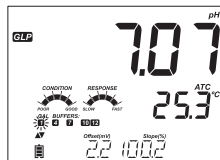

In Standard Mode, Condition and Response gauges are visible on the day of calibration (See Electrode Condition And Electrode Response Time page 29). If configured in SETUP, a countdown message displays the number of days remaining until a new Calibration is due.

If using a HI1311 or HI12301 sensor, the glass impedance is continuously monitored, updated and reported here and the Junction Condition Gauge is fully visible.

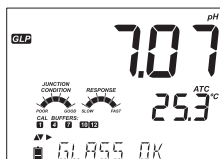

pH MEASUREMENT

When a pH electrode is connected, the instrument will recognize it and the "REMOVE PROTECTIVE AND FILLING CAPS" message will be displayed along with "PH". Press any key to skip the message. The instrument will enter measurement mode. Make sure the electrode has been calibrated before taking measurements.



Rinse the pH sensor with water and a sample if possible. Submerge the electrode tip approximately 3 cm (1¼") into the sample to be tested and stir sample gently. Allow time for the electrode to stabilize.

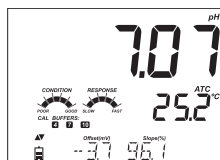

The pH is displayed on the first LCD line and the temperature on the second LCD line. Using the ∇/\blacktriangle keys, date, time, battery status and offset with slope can be displayed on the third LCD line. If the reading is out of measurement range, the closest full scale value will be displayed blinking on the first LCD line.

If measurements are taken successively in different samples, it is recommended to rinse the electrode thoroughly with deionized water or tap water and then with some of the next sample to prevent cross-contamination. The pH reading is affected by temperature. The temperature effect is compensated for using the temperature sensor inside the probe. The resulting measurement is the actual pH at the temperature of measurement.

Error Messages During Measurement

If the pH or temperature exceeds the limits of the sensor, the message “ELECTRODE OUT OF SPEC” will scroll on the third LCD line. The temperature will continue to be displayed. If temperature exceeds the meter specification of 120 °C, then “120 °C” will blink on the display. If interval logging, the message “OUT OF SPEC.” will alternate with the LOG specific message in both these cases and the Log file will indicate a “°C!” next to the data.

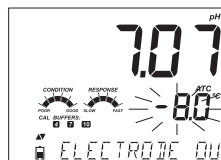

In case the temperature sensor is damaged, “BROKEN TEMPERATURE SENSOR” will be displayed and the temperature will display “25.0” and the unit tag blinking on the second LCD line. The Log file will indicate “°C!!” next to the data.

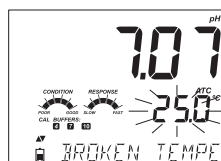

mV Reading Of The pH

The mV reading of the measured pH can be displayed on the LCD by pressing the RANGE/▶ key.



Range Specific Messages Displayed On Third LCD Line During Measurement

All the messages described in General Setup (page 14) are displayed in pH range.

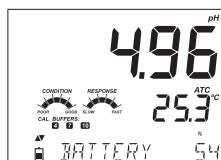

- Temperature Sensor Problem (if there is one)
- Cal Due or Offset and Slope Value
- Time
- Date
- Battery or Charge Status
- Logging Messages
- Out of Calibration Range

RELATIVE mV CALIBRATION

Calibration Procedure

Pour small quantity of solution into clean beakers. If possible, use plastic beakers to minimize any EMC interferences.

Submerge the ORP electrode approximately 3 cm (1¼") into the solution and stir gently. Press **CAL/MODIFY** key when the instrument is in RELATIVE mV measurement mode. The "CAL" tag will appear and the Absolute mV is displayed on the primary LCD line and "AbS" message on the secondary LCD line. The "⌚" will be displayed and "WAIT" will blink on the third LCD line until the reading is stable.

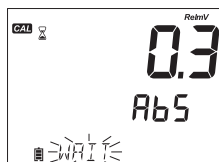

If the reading is out of range, "WRONG" will be displayed on the third LCD line.

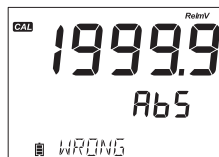

When the absolute reading is stable and in measurement range, the instrument asks for confirmation, the "CFM" tag will blink.

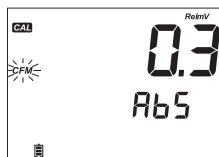

Press **GLP/CFM** key to confirm calibration. The instrument will display "0.0" RelmV on the primary LCD line with "CFM" tag blinking and "MANUAL" message on third LCD line. In this moment the relative mV offset is equal to absolute mV reading.

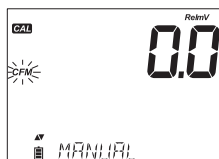

Use the **▼/▲** keys for changing the displayed Relative mV value.

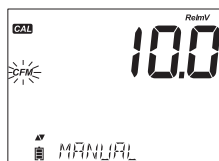

If the calculated offset is higher than ± 2000 mV the "MAX LIMIT REACHED" message will scroll on the third LCD line. Until the error is eliminated the value cannot be confirmed.

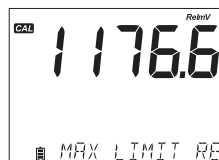

Press **GLP/CFM** key to confirm the relative mV value. The display will show "SAVING" and returns to measurement mode.



Note: The relative mV value can be changed only inside the relative mV offset window (± 2000 mV).



RELATIVE mV GLP INFORMATION

Good Laboratory Practice (GLP) refers to a quality control function used to ensure uniformity of sensor calibrations and measurements. The dedicated GLP key opens a file of the latest calibration information. Use the ∇/\blacktriangle keys to scroll the stored information. This includes the time and date of the last calibration, the sensor serial number and the offset. This information is also included with every data log.

If calibration has not been performed, the instrument displays a blinking "NO CAL" message.

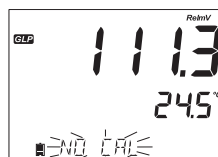

The relative mV calibration offset is displayed on the third LCD display.



Pressing the ∇/\blacktriangle keys, the last calibration date (yyyy.mm.dd) together with the current reading is displayed.

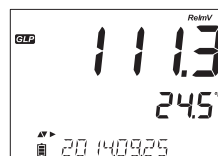

The time of the last calibration is displayed along with the current reading.

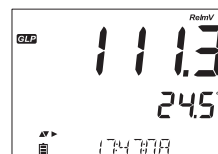

If disabled, "EXPIRATION WARNING DISABLED" is displayed.

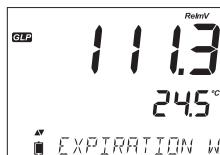

Or if enabled the number of days until the calibration alarm "CAL DUE" will be displayed. (i.e. "CAL EXPIRES IN 2 DAYS")



The number of days since the calibration expired. (i.e. "CAL EXPIRED 2 DAYS AGO").

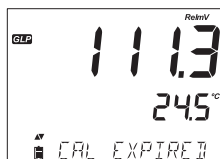

The probe serial number together with the current reading.

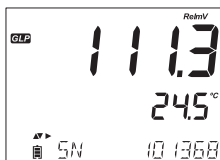

RELATIVE mV MEASUREMENT

When an ORP electrode is connected, the instrument will recognize it and the probe code will be displayed along with "ORP". Press any key to skip the message. The instrument will enter in measurement mode. Rinse the sensor with water and a sample if possible. Submerge the electrode tip approximately 3 cm (1 1/4") into the sample to be tested and stir sample gently. Allow time for the electrode to stabilize.

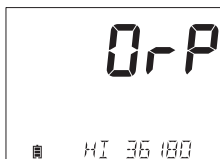

The Relative mV value is displayed on the first LCD line and the temperature on the second LCD line.

Using the ∇/\blacktriangle keys, date, time, battery status and offset can be displayed on the third LCD line. If the reading is out of measurement range, the closest full scale value will be displayed blinking on the first LCD line.

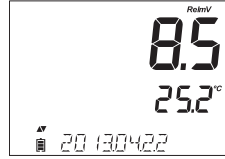

Error Messages During Measurement

If the mV or temperature exceeds the limits of the sensor, the message "ELECTRODE OUT OF SPEC" will scroll on the third LCD line. The temperature will continue to be displayed. If temperature exceeds the meter specification of 120 °C, then "120 °C" will blink on the display. If interval logging, the message "OUT OF SPEC." will alternate with the LOG specific message in both these cases and the Log file will indicate a "°C!" next to the data.

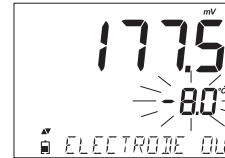

In case the temperature sensor is damaged, "BROKEN TEMPERATURE SENSOR" will be displayed and the temperature will display "25.0" and the unit tag blinking on the second LCD line. The Log file will indicate "°C!!" next to the data.

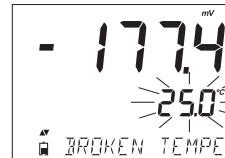

Relative mV Reading

The RelmV reading can be displayed on the LCD by pressing the RANGE/▶ key.

The relative mV reading is equal to the difference between the absolute mV input and the relative mV offset established in the relative mV calibration.



$$\begin{matrix} \text{Absolute} & \pm & \text{Offset} & = & \text{Relative} \\ \text{mV} & & \text{mV} & & \text{mV} \end{matrix}$$



pH PROBE MAINTENANCE

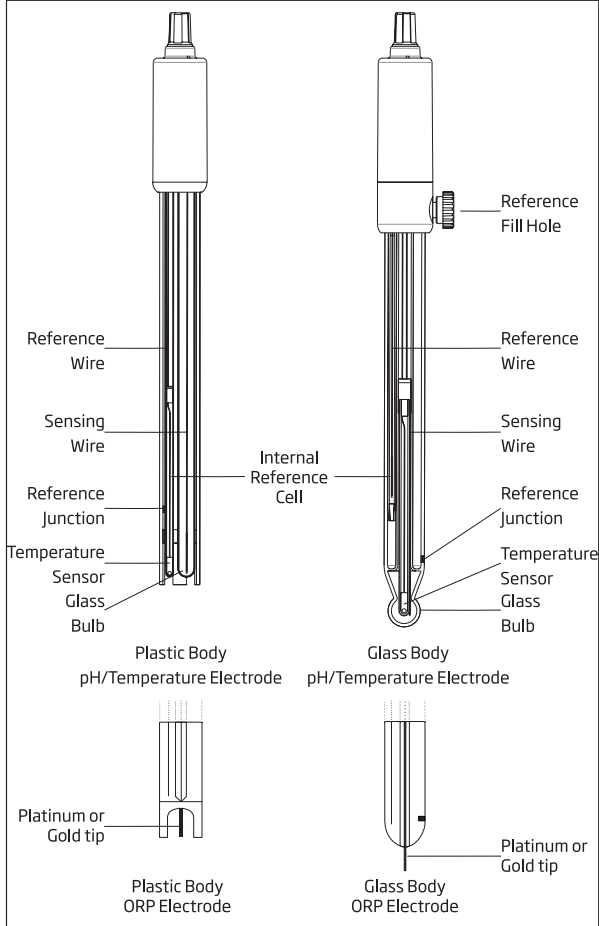

Remove the protective cap of the pH electrode.

DO NOT BE ALARMED IF SALT DEPOSITS ARE PRESENT.

This is normal with electrodes. They will disappear when rinsed with water.

During transport, tiny bubbles of air may form inside the glass bulb affecting proper functioning of the electrode. These bubbles can be removed by “shaking down” the electrode as you would do with a glass thermometer. If the bulb and/or junction is dry, soak the electrode in [HI70300](#) or [HI80300](#) storage solution for at least one hour.

For refillable electrodes:

If the filling solution (electrolyte) is more than 2½ cm (1”) below the fill hole, add [HI7082](#) or [HI8082](#) 3.5M KCl Electrolyte Solution for double junction electrodes.

Unscrew the fill hole cover during measurements so the liquid reference junction maintains an outward flow of electrolyte.

Measurement

Rinse the electrode tip with distilled water. Submerge the tip 3 cm (1¼”) in the sample and stir gently for a few seconds.

For a faster response and to avoid cross-contamination of the samples, rinse the electrode tip with a few drops of the solution to be tested, before taking measurements.

Storage Procedure

To minimize clogging and ensure a quick response time, the glass bulb and the junction should be kept moist and not allowed to dry out.

Replace the solution in the protective cap with a few drops of [HI70300](#) or [HI80300](#) Storage Solution or, in its absence, Filling Solution ([HI7082](#) or [HI8082](#) for double junction electrodes).

Follow the preparation procedure before taking measurements.

Note: NEVER STORE THE ELECTRODE IN DISTILLED OR DEIONIZED WATER.

Periodic Maintenance

Inspect the electrode and the cable. The cable used for connection to the instrument must be intact and there must be no points of broken insulation on the cable or cracks on the electrode stem or bulb. Connectors must be perfectly clean and dry. If any scratches or cracks are present, replace the electrode. Rinse off any salt deposits with water.

For refillable electrodes: Refill the reference chamber with fresh electrolyte ([HI7082](#) or [HI8082](#) for double junction electrodes). Allow the electrode to stand upright for 1 hour.

Follow the Storage Procedure above.

Cleaning Procedure

Use diagnostic messages to aid pH electrode troubleshooting. Several cleaning solutions are available:

- General — Soak in Hanna Instruments [HI7061](#) or [HI8061](#) General Cleaning Solution for approximately ½ hour.
- Protein — Soak in Hanna Instruments [HI7073](#) or [HI8073](#) Protein Cleaning Solution for 15 minutes.
- Inorganic — Soak in Hanna Instruments [HI7074](#) Inorganic Cleaning Solution for 15 minutes.
- Oil/grease — Rinse with Hanna Instruments [HI7077](#) or [HI8077](#) Oil and Fat Cleaning Solution.

Note: After performing any of the cleaning procedures, rinse the electrode thoroughly with distilled water, refill the reference chamber with fresh electrolyte (not necessary for gel-filled electrodes) and soak the electrode in HI70300 or HI80300 Storage Solution for at least 1 hour before taking measurements.

Temperature Correlation For pH Sensitive Glass

Verify the temperature range by reading the limits on electrodes cap. The pH electrode’s life also depends on the temperature that is used. If constantly cycled between two temperatures, the life of the electrode is drastically reduced.

Alkaline Error

High concentrations of sodium ions interfere with readings in alkaline solutions. The pH at which the interference starts to be significant depends upon the composition of the glass. This interference is called alkaline error and causes the pH to be underestimated. Hanna Instruments’s glass formulations have the indicated characteristics. Sodium Ion error for various glass types at ambient temperature:

Alkali Error with 0.1 mol/L Na⁺

pH	GP	HT	LT
12.5	0.11	0.05	0.28
13.0	0.23	0.11	0.35
13.5	0.35	0.16	0.45
14.0	0.48	0.20	0.54

Alkali Error with 1.0 mol/L Na⁺

pH	GP	HT	LT
11.5	0.11	0.01	0.46
12.0	0.21	0.06	0.62
12.5	0.32	0.11	0.79
13.0	0.43	0.15	
13.5	0.45	0.21	
14.0	0.65	0.27	

ORP PROBE MAINTENANCE

Remove the protective cap off the ORP electrode.

Wash off any SALT DEPOSITS. This generally confirms the reference junction is free flowing.

If the storage cap is dry, the reference junction may be dry also. Soak the electrode in HI70300 or HI80300 storage solution for at least one hour.

Keep the reference electrolyte topped off and the fill hole cover off during operation.

Add HI7082 or HI8082 3.5M KCl Electrolyte Solution for double junction electrodes.

Pretreatment

For a faster response, pretreat the ORP metal surface by soaking it for 15 minutes. Pretreatment with HI7091 Reducing Pretreatment Solution, or HI7092 Oxidizing Pretreatment Solution can prepare the metal surface for faster electron exchange with sample. See mV and pH to determine what treatment you should use.

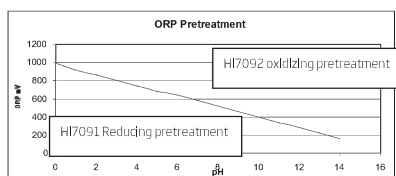

Measurement

Rinse the electrode tip with distilled water. Submerge the tip 3 cm (1¼") in the sample and stir gently for a few seconds.

For a faster response and to avoid cross-contamination of the samples, rinse the electrode tip with a few drops of the sample before taking measurements.

Storage Procedure

To minimize clogging and ensure a quick response time, protect the ORP sensor by using the storage cap. Add a few drops of [HI70300](#) storage solution to the cap to keep the reference junction wetted.

Periodic Maintenance

Inspect the sensor and cable. The cable used for connection to the edge must be intact and with no points of broken insulation.

The ORP metal surface must be smooth with no scratches. The metal surface can be polished with a fine-grained emery cloth or powdered alumina.

Cleaning Procedure

Use diagnostic messages to aid troubleshooting. Several cleaning solutions are available: See pH cleaning for specific contaminants or use a solvent system capable of dissolving the coating firm.

After performing any of the cleaning procedures, rinse the electrode thoroughly with distilled water, and refill the reference chamber with fresh electrolyte (not necessary for gel-filled electrodes) and soak the electrode in [HI70300](#) or [HI80300](#) Storage Solution for at least 1 hour before taking measurements.

Temperature dependence for ORP sensors

The oxidation-reduction potential (ORP) displayed in mV, is the voltage that results from the difference in potential between the platinum metal surface and the Ag/AgCl reference electrode. ORP values are not temperature compensated, although ORP mV can change with temperature (e.g. reference electrode potential changes and sample equilibrium changes). It is important to report ORP values together with the reference electrode used and the temperature of measurement.

TROUBLESHOOTING GUIDE

Symptoms	Problems	Solution
No sensor connection.	Sensor model not recognized.	Make certain, 3 mm connector is in all the way by pushing firmly into probe input.
Slow response/ excessive drift.	Dirty pH electrode.	Clean the electrode and then soak the tip in HI7061 or HI8061 for 30 minutes.
Readings fluctuate up and down (noise).	pH: Clogged/ dirty junction. Low electrolyte level (refillable electrodes only).	Clean the electrode. Refill with fresh solution (for refillable electrodes only). Check cable and connectors.
The meter does not accept the buffer/ standard solution for calibration.	pH: Dirty electrode or contaminated buffer.	Follow the cleaning procedure. If still no results, replace the electrode. Replace buffer.
If the display shows: "pH" and "-2.00" or "16.00" blinking.	Out of range in the pH scale.	A) Verify that the shipping cap has been removed. B) Make sure the pH sample is in the specified range. C) Check electrolyte level and general state of the electrode.
If the display shows: "mV" and "-1000" or "1000" blinking.	Out of range in the mV scale.	A) Verify the shipping cap has been removed. B) Make sure the sample pH is within specified range. C) Verify electrolyte level in pH sensor is topped off. D) Verify no bubbles inside pH membrane.
The meter does not measure temperature. "----" is displayed on second LCD line.	Broken temperature sensor.	Replace the probe.
The meter fails to calibrate or gives faulty readings.	Broken pH electrode.	Replace the electrode.
At startup the meter displays all LCD tags permanently.	One of the keys is stuck.	Check the keyboard or contact your local Hanna Instruments Office.
CAL "Prod" message at startup.	Instrument was not factory calibrated or lost factory calibration.	Contact your local Hanna Instruments Office for help.

	pH, mV in pH, mV in ORP	Temperature
Range	-2.00 to 16.00 pH -2.000 to 16.000 pH* ±1000.0 mV in pH ±2000.0 mV in ORP	-20.0 to 120.0 °C; -4.0 to 248.0 °F**
Resolution	0.01 pH 0.001 pH* 0.1 mV in pH 0.1 mV in ORP	0.1 °C; 0.1 °F
Accuracy @ 25 °C / 77 °F	±0.01pH ±0.002 pH* ±0.2 mV in pH ±0.2 mV in ORP (±999.9 mV) ±1 mV in ORP (±2000 mV)	±0.5 °C; ±0.9 °F
pH Calibration	Automatic, up to 3 points (5 points*) calibration, 5 standard (7 standard*) buffers available (1.68*, 4.01 or 3.00, 6.86, 7.01, 9.18, 10.01, 12.45*) and 2 custom buffers*	
Relative mV Calibration	Single point calibration	
Temperature compensation	Automatic -5 to 100 °C (23 to 212 °F) (using integral temperature sensor)	
Log feature	Up to 1000* records organized in: Log on demand (Max. 200 logs) Log on stability (Max. 200 logs) Interval logging*(Max. 600 samples; 100 lots)	
Additional Specifications		
PC Interface	Micro USB	
Storage Interface	USB	
Power Supply	5 VDC Adapter (included)	
Environment	0-50 °C (32-122 °F) Max 95% RH non-condensing	
Dimensions	202 x 140 x 12 mm (7.9 x 5.5 x 0.5")	
Weight	250 g (8.82 Oz)	
pH Electrode	HI11310 Intelligent pH/temperature electrode (included)	

*Standard Mode Only

** pH and temperature will be reduced to actual probe/sensor limits.

Electrodes/Probes

HI10530	Triple ceramic, double junction, low temperature glass body, refillable pH electrode with conical tip and temperature sensor
HI10430	Triple ceramic, double junction, high temperature glass body, refillable pH electrode with temperature sensor
HI11310	Glass body, double junction, refillable pH/temperature electrode
HI11311	Glass body, double junction, refillable pH/temperature electrode with enhanced diagnostics
HI12300	Plastic body, double junction, gel filled, non refillable pH/temperature electrode
HI12301	Plastic body, double junction, gel filled, non refillable pH/temperature electrode with enhanced diagnostics
HI10480	Glass body, double junction with temperature sensor for wine analysis
FC2320	Double junction, open reference, non refillable, electrolyte viscolene, PVDF body with conical tip, pH/temperature electrode
FC2100	Double junction, open reference, non refillable, electrolyte viscolene, glass body with conical tip, pH/temperature electrode
FC2020	Double junction, open reference, non refillable, electrolyte viscolene, PVDF body with conical tip, pH/temperature electrode
HI36180	Glass body, double junction, refillable ORP/temperature probe
HI36200	Plastic body, single junction gel filled, non refillable ORP/temperature probe

pH Buffer Solutions

HI70004P	pH 4.01 Buffer Sachets, 20 mL (25 pcs.)
HI70007P	pH 7.01 Buffer Sachets, 20 mL (25 pcs.)
HI70010P	pH 10.01 Buffer Sachets, 20 mL (25 pcs.)
HI7001L	pH 1.68 Buffer Solution, 500 mL
HI7004L	pH 4.01 Buffer Solution, 500 mL
HI7006L	pH 6.86 Buffer Solution, 500 mL
HI7007L	pH 7.01 Buffer Solution, 500 mL
HI7009L	pH 9.18 Buffer Solution, 500 mL
HI7010L	pH 10.01 Buffer Solution, 500 mL
HI8004L	pH 4.01 Buffer Solution in FDA approved bottle, 500 mL
HI8006L	pH 6.86 Buffer Solution in FDA approved bottle, 500 mL
HI8007L	pH 7.01 Buffer Solution in FDA approved bottle, 500 mL

HI8009L pH 9.18 Buffer Solution in FDA approved bottle, 500 mL

HI8010L pH 10.01 Buffer Solution in FDA approved bottle, 500 mL

Electrode Storage Solutions

HI70300L Storage Solution, 500 mL

HI80300L Storage Solution in FDA approved bottle, 500 mL

Electrode Cleaning Solutions

HI70000P Electrode Rinse Sachets, 20 mL (25 pcs.)

HI7061L General Cleaning Solution, 500 mL

HI7073L Protein Cleaning Solution, 500 mL

HI7074L Inorganic Cleaning Solution, 500 mL

HI7077L Oil & Fat Cleaning Solution, 500 mL

HI8061L General Cleaning Solution in FDA approved bottle, 500 mL

HI8073L Protein Cleaning Solution in FDA approved bottle, 500 mL

HI8077L Oil & Fat Cleaning Solution in FDA approved bottle, 500 mL

Electrode Refill Electrolyte Solutions

HI7082 3.5M KCl Electrolyte, 4x30 mL, for double junction electrodes

HI8082 3.5M KCl Electrolyte in FDA approved bottle, 4x30 mL, for double junction electrodes

ORP Standard Solutions

HI7021L ORP Test Solution 240mV @ 25 °C/ 77 °F, 500 mL

HI7021M ORP Test Solution 240mV @ 25 °C/ 77 °F, 230 mL

HI7022L ORP Test Solution 470mV @ 25 °C/ 77 °F, 500 mL

HI7022M ORP Test Solution 470mV @ 25 °C/ 77 °F, 230 mL

ORP Pretreatment Solutions

HI7091L Reducing Pretreatment Solution

HI7092L Pretreatment oxidizing solution, 500 mL

HI7092M Pretreatment oxidizing solution, 230 mL

Other Accessories

HI75110/220U Voltage adapter from 115 Vac to 5 Vdc (USA plug)

HI75110/220E Voltage adapter from 230 Vac to 5 Vdc (European plug)

HI76404W Electrode holder

HI2000WCW Wall cradle

HI2000BCW Bench cradle

HI920015 Micro USB cable

Warranty

The edge® pH is warranted for two years against defects in workmanship and materials when used for their intended purpose and maintained according to instructions. Electrodes and probes are warranted for six months. This warranty is limited to repair or replacement free of charge.

Damage due to accidents, misuse, tampering or lack of prescribed maintenance is not covered.

If service is required, contact your local Hanna Instruments Office. If under warranty, report the model number, date of purchase, serial number and the nature of the problem. If the repair is not covered by the warranty, you will be notified of the charges incurred. If the instrument is to be returned to Hanna Instruments, first obtain a Returned Goods Authorization (RGA) number from the Technical Service department and then send it with shipping costs prepaid. When shipping any instrument, make sure it is properly packed for complete protection.

Hanna Instruments reserves the right to modify the design, construction or appearance of its products without advance notice.

World Headquarters

Hanna Instruments Inc.
Highland Industrial Park
584 Park East Drive
Woonsocket, RI 02895 USA
www.hannainst.com

Local Office

Hanna Instruments USA
270 George Washington Highway
Smithfield, RI 02917
Phone: 800.426.6287
Fax: 401.765.7575
e-mail: tech@hannainst.com

